

ELTAKO.COM

75 YEARS OF INNOVATION.

A STRONG FOUNDATION FOR AN EXCITING FUTURE.

MAIN CATALOGUE 2024

Eltako

INNOVATIVE FROM DAY ONE.

Innovation is not just part of our philosophy. It is part of our DNA. We have been putting it into action for more than 70 years. Thinking ahead and thinking new is in our nature. We have continued to develop from the inventor of the Eltako impulse switch to a provider of professional smart home solutions.

This development is now reflected in our communications - with the establishment of two new brands:

„Eltako Professional Standard“ as a provider of conventional building technology and „Eltako Professional Smart Home“ as a provider of innovative and professional smart home solutions.

*This move underlines that Eltako is
THE HOME OF INNOVATION.*



CONTENTS

PROFESSIONAL SMART HOME

Series 14 - a new chapter in the centralised installation of wireless actuators

1

The remote switch system and wired bus pushbuttons

2

Flush mounting switching and dimming actuators for decentralised installation

3

Powerline - Power lines for kilometer-wide communication between sensors and actuators

4

Pushbutton and switch ranges motion sensors, window/door contacts, Temperature- and other Sensors

5

Controllers and Gateways - EnOcean, ZigBee, KNX, DALI, MQTT, WLAN and much more

6

Eltako DALI - The professional light control for all needs

7

Series 62-IP - IP actuators for decentralised installation. Apple Home certified, REST-API and „built for Matter“

8

Universal dimmer switches, capacity enhancer and 1-10 V controllers

9

Three-phase energy meters and one-phase energy meters

10

Electronic impulse switches

11

Electronic switching relays, control relays and coupling relays

12

Multifunction time relays, time relays and timers

13

Mains disconnection relays, operating hours impulse counter, current-, mains monitoring- and current-limiting relays

14

Staircase time switches and off-delay timers

15

Cable-bound shading systems and roller shutter control

16

Switching power supply units and wide-range switching power supply units

17

Electromechanical impulse switches

18

Electromechanical switching relays and installation contactors

19

Accessories wireless and others

Z

Technical data wireless actuators, teach-in list, operating distances and contents of Eltako wireless telegrams

T

Type comparison table, warranty regulations, terms of delivery and index

S

PROFESSIONAL STANDARD

ALL SERVICES QUICKLY IN VIEW.

The performance of our devices has become so complex that we have devised pictograms to depict technical features of particular importance.



MINIMIZED STANDBY LOSS

of electronic devices supports international efforts to reduce energy consumption. 98% of the devices produced by ELTAKO have a standby loss of less than 0.8 watt.



BISTABLE SWITCHING RELAYS

help electronic switchgear to reduce heating and current consumption. This prolongs lifetime and reduces or avoids standby loss. After installation the short automatic synchronization in the Off position is carried out, partly at initial operation.



IMPULSE SWITCHES FOR CENTRAL CONTROL

offer important basic functions, even if they are not used for central control. In order to reduce the type variety we offer them partially only completely equipped with additional control inputs central on/off.



BIDIRECTIONAL WIRELESS

expands the functions of the wireless actuators by another dimension: every change in state and incoming central control telegrams are confirmed by wireless telegram. This wireless telegram can be taught-in in other actuators, Professional Smart Home controllers and in universal displays. In addition, a repeater function can partially be enabled in these actuators to reach other actuators that are located far away from the wireless source.



WITHOUT STAND-BY LOSS

Electromechanical switchgear and electronic switching devices with a special Eltako technology as well as numerous pushbuttons, sensors and transmitter modules work **without stand-by loss**.



THE UNIVERSAL CONTROL VOLTAGE 12 TO 230 V AC 50-60 HZ AND 12 TO 230 V DC,

covers the commonly used control voltage range with one device only. We use the international abbreviation UC (universal current).



GLOW LAMPS FOR ILLUMINATION OF PUSH-

BUTTONS in parallel to pushbutton contacts can make life difficult for switchgear. A glow lamp current up to 150 mA is permitted for particular device.



THE ELTAKO RS485 BUS

connects the wireless antenna modules FAM14, FEM and/or pushbutton input modules FTS14EM with the RS485 bus actuators in the switchboard or distribution box. It is an often used and very safe 2-wire bus.



ZERO PASSAGE SWITCHING

of the mains voltage sinusoidal wave prolongs contact lifetime. This provides very high switching capacities and the shallow current flow curve protects the connected consumers.



With the patented Eltako Duplex technology (DX) the normally potential-free contacts can still switch in zero passage when switching 230V AC 50Hz and therefore drastically reduce wear. Simply connect the neutral conductor to the terminal (N) and L to the contact input terminal (L). This gives an additional standby consumption of only 0.1 Watt.



SOLID STATE RELAYS

operate noiseless, switch in zero passage and are very durable, even at high switching frequency.



UNIVERSAL DIMMER SWITCHES

for R, L and C loads. Our universal dimmer switches recognize automatically the connected load and adjust their dimmer function accordingly. Other dimmers have to be replaced when luminaires with different kind of loads will be used later on.



Only universal dimmer switches with the added ESL marking and added LED marking have the associated comfort settings.



ENCRYPTED WIRELESS SYSTEM

The internet transmissions of controllers to smartphones, the cloud and M2M communications are generally highly encrypted. Many wireless sensors can be taught-in encrypted in actuators of the Series 61, 62 and 71 as well as the FAM14.

More info? Simply scan QR codes & get more product information.



Various possible uses for lighting, shading, indoor climate and security. Discover the diversity of our portfolio now.



SYSTEM COMPONENT

Expand existing systems and thereby round off the interaction of the electrical installations.



LIGHTING

Something for everyone: Lighting control via switch, button, GFA5-APP or preset light scenes.



SHADING

Automatically control awnings, blinds and roller shutters so that they protect against too much sun and are not damaged in bad weather.



INDOOR CLIMATE

With the intelligent control from Eltako, room temperatures can be adjusted individually for each room and switched off automatically.



SAFETY

Many products for maximum security! Dangers are quickly identified with the help of smoke detectors, motion detectors, window and door monitors.

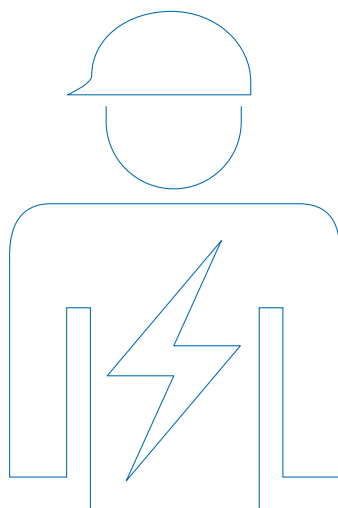

Only a trained electrician may install our devices with mains voltage connection, otherwise there is a risk of fire or electric shock. It is therefore prohibited to sell to other customers for this reason otherwise the risk passes to the seller.

Stock types: Delivery usually from stock.

Preferred types: The well-assorted wholesalers always have them in stock.

Subject to change! The product descriptions on the internet are valid only for newly manufactured devices at that time.

Also this print-catalogue is only a snap-shot. Older and newer devices might differ from them. Therefore, only the operation instructions enclosed with the devices are binding. Terms of delivery see page S-4.

All articles are available with Declarations of Conformity that document compliance of the devices with the Low-Voltage Directive 2014/35/EU and/or the EMC Directive 2014/30/EU.

The **CE** and UKCA marks are affixed to the devices and the packaging. All articles comply with EU Directives 2011/65/EU (RoHS) and 1907/2006/EC (REACH) and contain no substances that are on the candidate list.

KEY TO TYPE IDENTIFICATION
KEY TO ABBREVIATIONS

KEY TO TYPE IDENTIFICATION

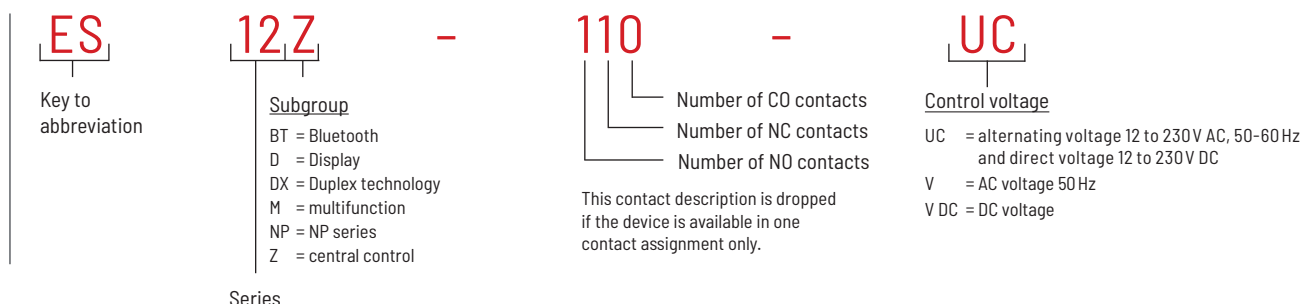

KEY TO ABBREVIATIONS

	MEANING
AR	Current relay
AVZ	Single function time relays, AV operate delay
BP	Blisterpack
BZR	Operating hours counter
DCM	DC motor relay
DL	DALI
DS	Spacer
DSS	Socket (Type F)
DSZ	Three-phase energy meter
DW	Double rocker
DX	Duplex technology
EAW	Single function time relays, EW+AW+EAW Fleeting NO contact and fleeting NC contact
EGS	Impulse group switches
ER	Electronic relay
ES	Electronic impulse switch
ESR	Electronic impulse switch with integrated relay function
ETR	Isolating relay
EUD	Universal dimmer switch
EVA	Energy consumption indicator
F	Wireless sensors and actuators
FK	window contact
FR	Mains disconnection relay
G	Group switch
GBA	Housing for operating instructions
KM	Auxiliary contact
KR	Coupling relay
LRW	Light-twilight-wind sensor relay
LS	Light sensor
LUD	Capacity enhancer for universal dimmer switches
MFZ	Multifunction time relay

	MEANING
MS	Multi sensor
MSR	Multi sensor relay
MTR	Motor isolating relay
NLZ	Off delay timer
NR	Mains monitoring relay
P3K	Phase annunciator
PL	Powerline
R	Electromechanical switching relay
RVZ	Single function time relays, RV release delay
S	Electromechanical impulse switch
S2U	Timer
SBR	Current-limiting relay
SDS	Control dimmer switch for electronic ballast units
SNT	Switching power supply units
SS	Series switch
SSR	Solid state relay
ST	Socket outlet
SUD	1-10 V controller for universal dimmer switches
TGI	Single function time relays, TI clock generator
TLZ	Staircase time switch
U2RP	Universal DIN rail mounting plate
UIB	Universal installation box
W	Single rocker
WNT	Wide-range switching power supply units
WS	Wind sensor
WS	Wired switch
WSZ	Single-phase energy meter
WT	Wired pushbutton
XR	Installation contactor 25 A
XS	Electromechanical impulse switch 25 A

All articles are available with Declarations of Conformity that document compliance of the devices with the Low-Voltage Directive 2014/35/EU and/or the EMC Directive 2014/30/EU.

The **CE** and UKCA marks are affixed to the devices and the packaging. All articles comply with EU Directives 2011/65/EU (RoHS) and 1907/2006/EC (REACH) and contain no substances that are on the candidate list.

KEY TO TYPE IDENTIFICATION
KEY TO ABBREVIATIONS

SERIES OVERVIEW

DIN RAIL SERIES



Series 12



Series 14



Series 15

These products are designed for central installation on the DIN rail, making them easy to install and set up and always easily accessible for the installer.

BUILT-IN SERIES



Series 61



Series 62



PL



Series 81



Series 91

Products for box installation can be found in almost all product groups. Designed for installation in a switch box, they require little space. From individual solutions to complete building equipment, they serve everywhere.

DEVICES FOR INSTALLATION IN FALSE CEILINGS OR LIGHTS



BR 71

Products from the 71 series can be parameterised using the free PCT14 configuration software, which provides an expanded range of functions. They are mounted in the false ceiling or directly in the desired luminaire and are used for lighting, shading and switching.

INTERMEDIATE PLUGS



Here you will find products for switching, measuring and dimming for indoor and outdoor use. The portfolio of intermediate plug devices gives users the opportunity to make standard devices smart by simply plugging them in. They can then be controlled via an app, for example.

ENTER THE SMART HOME WORLD.

DISCOVER OUR INTELLIGENT TECHNOLOGIES!

No matter what system you wish to install, and in what kind of building – Eltako Professional Smart Home makes it possible. We offer intelligent, end-to-end, made-to-measure packages, not stand-alone solutions. Discover our impressive armory of products of exceptional high quality and extensibility. They offer great value for money and make any home into a smart home – and will turn you into your customers' very own knight in shining armor





**TOGETHER,
WE CAN GO
FURTHER.**

**HAND-IN-HAND WITH OUR PROFESSIONALS,
YOU'LL MAKE EVERY PROJECT A SUCCESS.**



Eltako Professional Standard simplifies system installation by means of a unique product portfolio, consistently high quality and outstanding value for money. We offer professional, practical support, enabling you to rapidly overcome any challenge. Working as a team, we'll get more done. And better.



REMOTE SWITCHES

The foundation stone of our quality products was the development of the impulse switch. Nowadays, the classics among our switching devices have become standard components in building installation systems – impulse switches and installation relays, either electromechanical or electronic.

REMOTE SWITCH SYSTEM

A cable-bound installation that has the potential to convert into a BUS system. The pushbutton input module FTS14EM is capable of sending control commands from conventional pushbuttons in order to utilise the full scope of our BUS actuators.

CENTRALISED WIRELESS

In the centralised Wireless Building system, wireless actuators of Series 14 are fitted centrally in the switch cabinet to control individual functions from there. This is based on the RS485-BUS.

DECENTRALISED WIRELESS

Decentralised actuators are mainly fitted in flush-mounted boxes. The consumer is directly connected – an ideal feature when renovating. It is also no problem to expand existing installations to include additional switching points.

ROLLER SHUTTER AND SHADING SYSTEMS CONTROL

A shading systems control adapted to weather and light conditions is easy to install and also saves energy. Perfect coordination of smart sensors and easy operation increases convenience and security.

YOUR ONE-STOP SOURCE OF INNOVATIVE SOLUTIONS.

We offer an end-to-end portfolio of both smart home and conventional building technologies, designed for ease of installation and backed by reliable manufacturer support. Our smart home products are versatile, intelligent and future-ready – delivering greater comfort, convenience, safety, security and energy efficiency. Discover what Eltako can do for you and your customers.



CONTROL

Anywhere, anytime control of your smart home. Open the blinds via voice activation from the comfort of your couch. Monitor your house via app while on vacation. Or turn on the living-room heating when you leave work. Our innovative control and visualisation capabilities make it possible.



COMFORT

Relax, and let your home do the hard work. The many central, time and automation functions available from Eltako allow entire houses to be configured and controlled in line with personal preferences.

SAFETY AND SECURITY

Smart is safe and secure. Eltako offers a variety of solutions that protect homes, including smoke detectors, camera surveillance systems, motion detectors, window and door monitoring devices and presence simulation.

LIGHTING

Whatever the mood you want, we provide the light to match. Activate, deactivate or dim interior, exterior or garden lights to produce exactly the effect you want – and to create your own personal feel-good ambience.



ENHANCED EFFICIENCY

Energy-efficient temperature control, automatic activation and deactivation of devices, and an energy-saving absence mode ensure a marked reduction in consumption. And smart metering delivers total visibility.

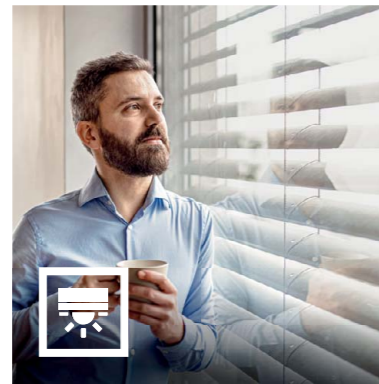

SHADING

Automatically control roller shutters, blinds and awnings with sensors, and time and central functions. The result is not just targeted coolness and shade, but also lower costs for heating and air-conditioning.



ROOM CLIMATE

Eltako systems enable heating, air conditioning and ventilation to be tailored to each room and need. You can go from a pleasantly cool bedroom, to a preheated bathroom, to a freshly ventilated kitchen. For the perfect start to your day.

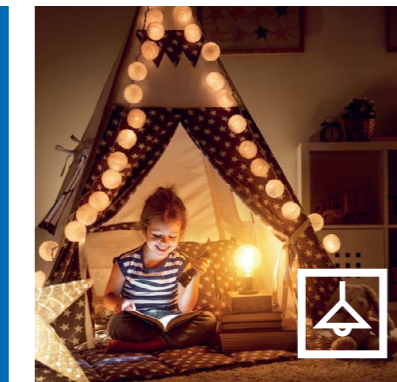
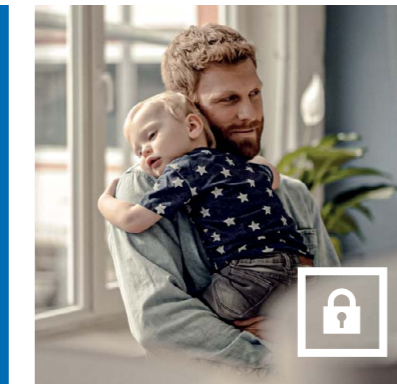
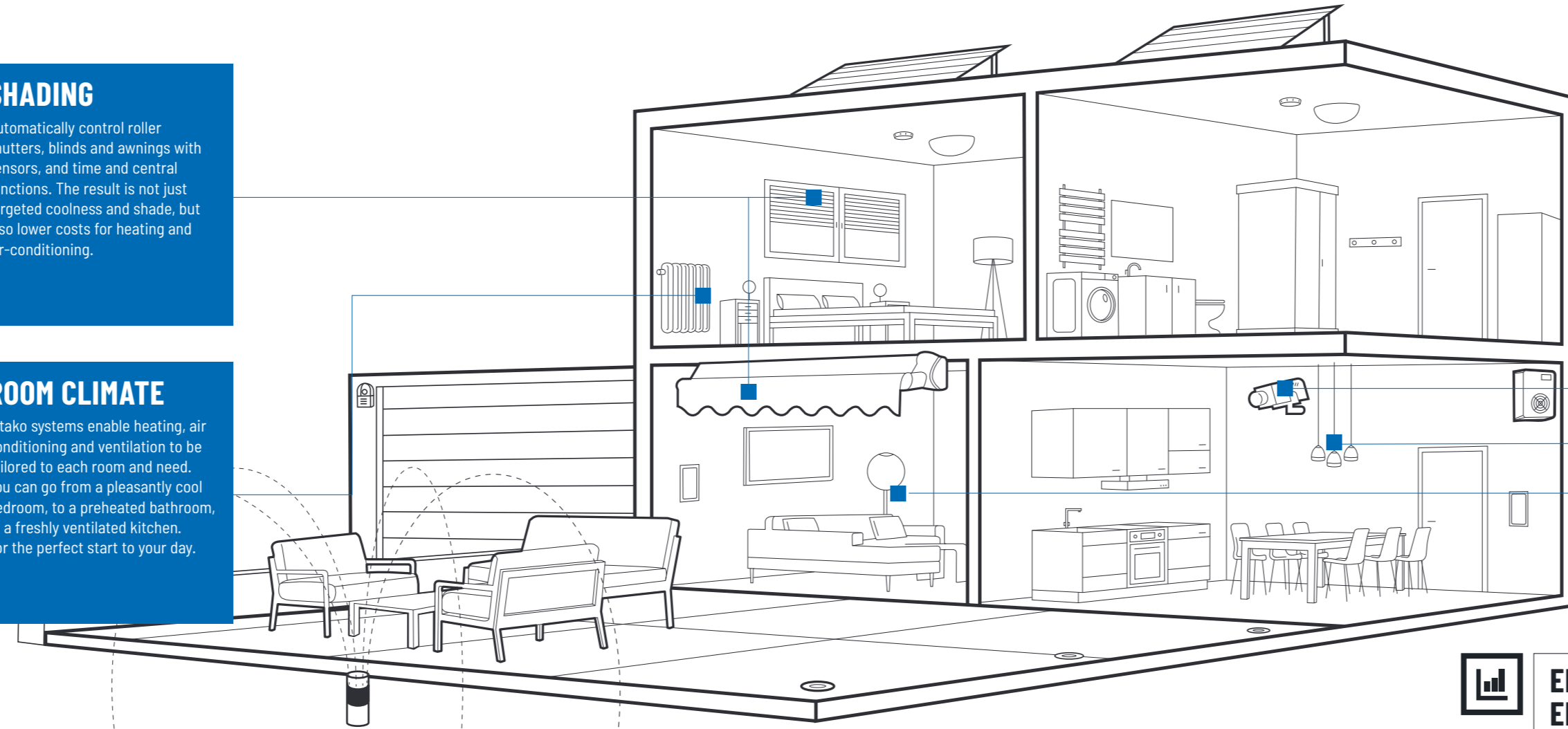

PROFESSIONAL SMART HOME CONTROLLER

The Professional Smart Home controllers are the heart of the network and communicate with components of the system, whether wired or wireless. Secure, encrypted remote access to the building is possible via an app.

ENERGY METERS

The simplest way to sharpen your awareness about how much energy you consume is to observe your power consumption. Our modern meters are easy to fit and supply all the important information.

POWERLINE

The Eltako Powerline BUS offers the option to use existing power cables as a BUS system. Sensor data are sent in telegrams over existing electricity wiring to the actuators.

DALI

Light control for all needs – from LED, tunable white and RGB dimmers through to control units.

PASSIVE AND ACTIVE SENSORS

Wireless pushbuttons, sensors with no batteries and smart wireless sensors can be fitted wherever they are required: to walls, ceilings, on glass or furniture without having to route additional wiring.

MULTIMEDIA

It is easy and convenient to operate using a smartphone, tablet or voice command. The ideal complement to this are wall and table docking stations with touch buttons for quick access to frequently used functions and scenes.



As a market and technology leader for building technologies, we know what our customers need – because we have more than 70 years' experience and, above all, because we are a reliable, fair and supportive partner. And we can meet any need, with the world's broadest product portfolio. Eltako delivers consistently excellent quality, ease of installation and great value for money – for genuine professionals.

NEW

**DSZ15DZ-3x80A MID
MFSR12DX-230V**
CHAPTER 10

**IP ACTUATORS
APPLE HOME CERTIFIED, REST-API
AND „BUILT FOR MATTER“.**

**ESR62NP-IP
EUD62NPN-IP
ESB62NP-IP**
CHAPTER 8



**BIDIRECTIONAL THREE-PHASE ENERGY
METER AND MULTIFUNCTION CURRENT
RELAY FOR EASY ENERGY MANAGEMENT**



**TIMERS AND MULTIFUNCTION TIME RELAY WITH BLUETOOTH FOR
CONFIGURATION VIA THE FREE ELTAKO CONNECT APP**

**SU12DBT/1+1-UC
S2U12DBT-UC
MFZ12DBT-UC
ASSU-BT/230V**
CHAPTER 13

IF YOU HAVE ANY QUESTIONS, JUST ASK US!!

OUR SUPPORT TEAM IS GLAD TO ASSIST YOU WITH INSTALLATION AND INFORM YOU ABOUT NEW PRODUCTS.

Just as professional as our products: Professional support from Eltako.

Technical support:
+49 711 943 500 25
technical-support@eltako.de

Commercial support:
+49 711 943 500 00
export@eltako.de



THE HOME OF INNOVATION.



Complete answers to your needs, not stand-alone, piecemeal products. We offer flexible complete solutions that turn any building into a professional smart home. Based on EnOcean technologies, our systems are future-proof and easily extensible. Genuine professional-standard quality – at a good price. That's Eltako Professional Smart Home.

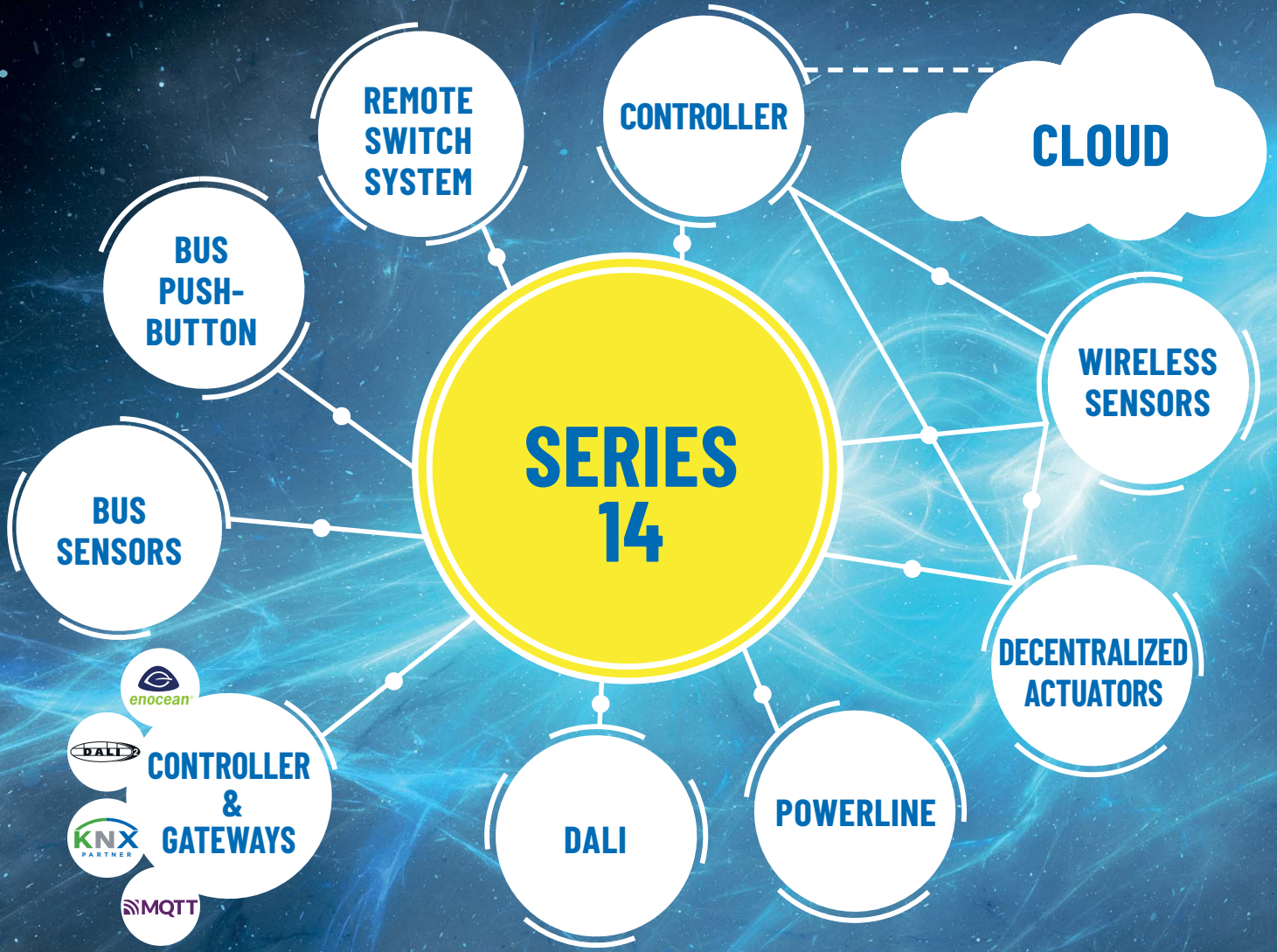

**FAM14
FSR14-2x
FUD14**

SERIES 14 – A NEW CHAPTER IN THE CENTRALISED INSTALLATION OF WIRELESS ACTUATORS.

Series 14 – RS485 bus rail-mounted devices for the centralised Wireless Building installation

RS485 bus wireless antenna module FAM14	1-3
Wireless antenna FA250 , FHM175 , FA200 and FAG55E-	1-4
PC Tool PCT14	1-5
RS485 bus actuator 4-channel impulse switch FSR14-4x	1-6
RS485 bus actuator 2-channel impulse switch FSR14-2x	1-7
RS485 bus actuator 2-channel impulse switch FSR14M-2x with active power measurement	1-8
RS485 bus actuator 4-channel impulse switch for LED F4SR14-LED	1-9
RS485 bus actuator noiseless 2-channel impulse switch FSR14SSR	1-10
RS485 bus actuator multifunction impulse switch with integrated relay function FMS14	1-11
RS485 bus actuator universal dimmer switch FUD14	1-12
RS485 bus actuator universal dimmer switch up to 800 W FUD14/800W	1-13
RS485 bus capacity enhancer FLUD14 for universal dimmer switch FUD14/800W	1-14
RS485 bus actuator dimmer switch controller FSG14 for EVG 1-10V	1-16
RS485 bus DALI gateway FDG14	1-17
RS485 bus wireless actuator PWM simmer switch for LED FRGBW14	1-18
RS485 bus actuator for shading elements and roller shutters FSB14	1-19
RS485 bus actuator for shading elements and roller shutters FSB14/12-24VDC	1-20
RS485 bus actuator multifunction time relay FMZ14	1-21
RS485 bus actuator staircase lighting time delay switch FTN14	1-22
RS485 bus actuator 2-speed fan relay F2L14	1-23
RS485 bus actuator heating/cooling relay FHK14	1-24
RS485 bus actuator 4-channel heating/cooling relay F4HK14	1-25
RS485 bus display timer FSU14	1-26
RS485 bus weather data gateway FWG14MS and multi sensor MS	1-27
Wireless weather data transmitter module FWS61-24V DC and RS485 bus multifunction sensor relay FMSR14	1-28
NEW RS485 bus single phase energy meter WSZ14DRS-32A MID with display and RS485 bus single-phase energy meter transmitter module FWZ14-65A	1-29
RS485 bus wireless three-phase energy meter, MID approval DSZ14DRS-3x80A MID	1-30
RS485 bus bidirectional three-phase meter DSZ14DRSZ-3x80A MID	1-31
RS485 bus three-phase meter for CT DSZ14WDRS-3x5A MID	1-32
RS485 bus energy meter data gateway FSDG14 and IR scanner for energy meters AIR	1-33
RS485 bus meter collector F3Z14D	1-34
RS485 bus gateway FGW14	1-35
NEW RS485 bus energy meters MQTT gateway via WLAN FGW14-W-IP and RS485 bus energy meters MQTT gateway via WLAN or LAN FGW14-WL-IP	1-36
RS485 bus multiple gateway with USB-A connection FGW14-USB	1-37

RS485 bus Telegramm-Duplizierer FTD14	1-38
RS485 bus coupler FBA14	1-39
The modular single room control	1-40
RS485 bus actuator single room control, heating/cooling for 2 zones with solid state relay FAE14SSR	1-41
RS485 bus actuator single room control, heating/cooling for 2 zones FAE14LPR	1-42
Thermal actuators TSA02NC-230V and TSA02NC-24V	1-43
Busbar SAS-6TE	1-43
Bus jumper connector BBV14 and BBV14/100	1-44
Spacer DS14	1-44
Wireless receiver antenna modules FEM and FEM65-wg	1-45
RS485 bus 1 and 2 level wireless repeater FRP14	1-46
RS485 bus wireless 4-fold transmitter module FSM14-UC	1-47
Switching power supply unit 12V/12W FSNT14	1-48
Accessories: Housing for operating instructions GBA14 , jumpers set STS14 and bus jumper tool SMW14	1-49
Maximum configuration of the Series 14 RS485 bus with 3 different gateways and 3 wireless receiver modules	1-50
Connection example: wireless antenna module with downstream actuators and meters	1-51
Technical data switching actuators and dimming actuators for the Eltako RS485 bus	1-52
Power requirement	1-53

The Eltako wireless system works with the reliable and worldwide standardized EnOcean wireless technology in 868 MHz.

It transmits ultra short and interference-proof signals with a range of up to 100 meters in halls.

Eltako wireless pushbuttons reduce the electrosmog load since they emit high-frequency waves that are 100 times weaker than conventional light switches. There is also a significant reduction in low-frequency alternating fields since fewer power cables need to be installed in the building.

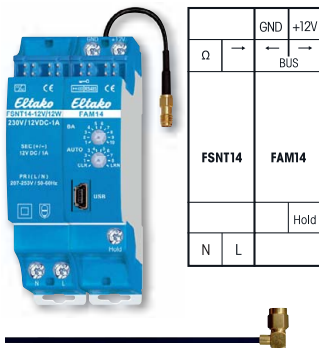

The enclosed small antenna can be replaced with a wireless antenna FA250 or an FA200 and FAG55E- (see page 1-4).

Function rotary switches

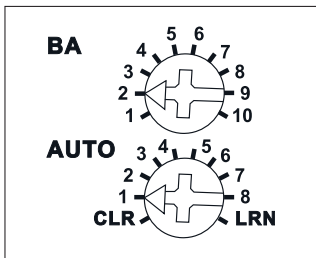

Standard setting ex works.



Manuals and documents in further languages:
<http://eltako.com/redirect/FAM14>

Housing for operating instructions
 GBA14 page 1-49.

FAM14

Wireless antenna module for the Eltako RS485 bus with exchangeable antenna. With enclosed power supply FSNT14-12V/12W. Bidirectional. Encrypted wireless. Only 0.8 watt standby loss. If required, a wireless antenna FA250 or FA200 can be connected.

Modular device for DIN-EN 60715 TH35 rail mounting. 1 module = 18 mm wide, 58 mm deep.
 Supply voltage 12V DC.

Connection to the Eltako RS485 bus. Bus wiring and power supply with jumpers.

The delivery includes 1 power supply FSNT14-12V/12W, 1 Spacer DS14, 2 terminators with printing Ω , 1/2 module, 3 jumpers 1 module (including 1 spare), 1 jumper 1,5 TE, 2 jumpers 1/2 module (including 1 spare) and 1 jumper installation tool SMW14.

If the power supply is subjected to a load of more than 4 W, a ventilation distance of 1/2 to neighboring devices must be maintained on the left side. With a load greater than 6 W, a 1/2 ventilation gap is also required between the FSNT14 and the FAM14 with the DS14 spacer.

A DS14 spacer and a long jumper are therefore included. If the total power requirement of a Series 14 bus system is higher than 10 W, an additional FSNT14-12V/12W must be used for every 12 W of additional power.

Optionally, 12 V DC can also be supplied at the GND/+12 V terminals.

The wireless antenna module FAM14 receives and tests all signals from wireless transmitters and repeaters within its receiving range. These are transmitted via an RS485 interface to RS485 bus switching actuators connected in series: Up to 126 channels can be connected to the Eltako RS485 bus. Bus cross wiring and power supply with jumper.

The attached second terminator should be plugged to **the last actuator**.

You can teach in up to 32 encrypted sensors.

Mini USB to connect to a PC, to create an equipment list, to configure the actuators using the PC tool PCT14 and for data backup. A QR code for downloading the PCT14 from the Eltako homepage www.eltako.com is included with the FAM14.

Gateways FGW14, FGW14-USB, FGW14W-IP and FGW14WL-IP are connected to the Hold terminal if following connections to the RS484 bus are present: with a PC over an RS232 bus, with up to 3 radio receiver modules FEM with a Sub Bus RS485 or with LAN/WLAN. The FTS14EM, FTS14TG and FWG14MS are also connected to the Hold terminal.

The lower rotary switch is required to teach in encrypted sensors and can be turned to AUTO 1 in operation. Unencrypted sensors need not be taught-in in the FAM14.

With the upper rotary switch BA 10 different operating modes can be set as described in the operating instructions.

The upper LED displays all perceived wireless commands in the reception area by short flickering.

The bottom LED lights up green if a connection from the PC tool PCT14 to the FAM14 was created. When reading or writing date the LED flickers green. The green LED goes out if the connection from the PC tool PCT14 to the FAM14 was terminated.

Meter special operating modes

In the meter operating modes, the focus is on the adjustable transmission speed of electricity meter data for external building energy managers. Data can be accessed and forwarded via connected gateways (FGW14, FGW14-USB, FGW14W(L)-IP). **Additional setting options are available for meters from production week 33/23.**

FAM14	RS485 bus wireless antenna module	Art. No. 30014000	123,40 €/pc.
--------------	-----------------------------------	--------------------------	---------------------

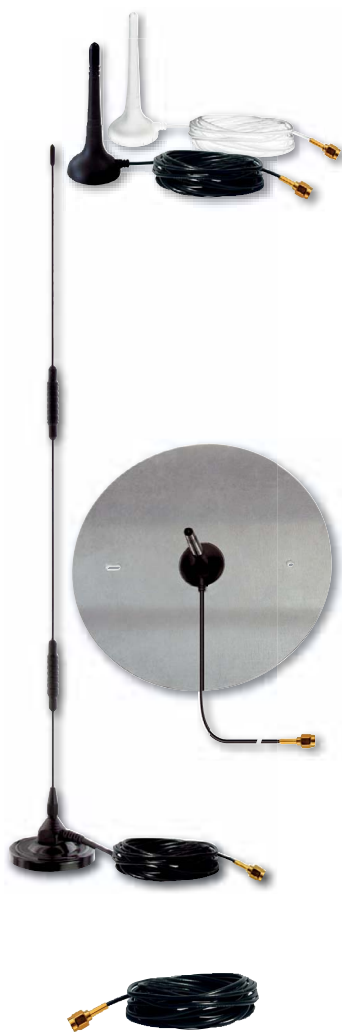

Manuals and documents in further languages:
http://eltako.com/redirect/FA250_FHM175_FA200



Manuals and documents in further languages:
<http://eltako.com/redirect/FAG55E->

FA250, FHM175 AND FA200



Wireless antenna **FA250** with magnetic base and 250 cm cable, black or white

The small enclosed wireless antenna of the wireless antenna modules and several wireless transmitter modules are replaceable by this larger 868MHz-HF-antenna to receive and transmit wireless signals to or from metal control cabinets.

It is mounted on the magnetic base externally and the 250 cm cable is routed inside the cabinet. The best performance is achieved by attaching the magnetic foot on a metal surface. The transmit and receive ranges are almost spherical around this antenna. Antenna height, only 10 cm. With SMA screw terminal. Extension by 5 m using wireless antenna extension FAV5 or by 10 m using FAV10.

HF ground FHM175 for the HF wireless antenna FA250, aluminium disc powder-coated (similar to RAL 9006) white aluminium, 4 mm thick, 175 mm diameter.

This HF ground optimizes the receiver and transmitter performance of the HF antenna FA250 (not included in the scope of supply) since the diameter has twice the length of the antenna plus its bar diameter.

A deepened steel disc with the diameter of the magnetic antenna coil is pressed into the center. Thereby the FA250 can easily be centered. The aluminium disc is formed with a hole and a slot to be fixed to the wall.

High-performance receive antenna FA200 with magnetic base and 200 cm cable

This antenna has a radial gain of up to 7 dBi and therefore has a much greater range than wireless antenna FA250. As a trade-off the receive power along the antenna axis is considerably lower. This must be taken into consideration when positioning the antenna. **It may only be used as a receive antenna.**

Antenna height 59 cm. With SMA screw terminal.

Extension by 5 m using wireless antenna extension **FAV5** or by 10 m using **FAV10**.

FA250	Wireless antenna with 250 cm cable, black	Art. No. 30000550	31,70 €/pc.
FA250-gw	Wireless antenna with 250 cm cable, grey white	Art. No. 30000553	31,70 €/pc.
FHM175	HF ground for FA250, aluminium disc powder-coated (similar to RAL 9006) white aluminium	Art. No. 30000555	91,80 €/pc.
FA200	High-performance receive antenna with 200 cm cable	Art. No. 30000551	81,00 €/pc.
FAV5	Antenna extension 5 m	Art. No. 30000552	41,50 €/pc.
FAV10	Antenna extension 10 m	Art. No. 30000554	52,00 €/pc.

FAG55E-



Wireless antenna in the housing for single mounting 80 x 80 x 15 mm or mounting into the E-Design55 switching system. With 100 cm cable.

The mounting plate can be screwed over a flush-mounting box with a screw spacing of 60 mm. In the housing there is a wireless antenna with ground plane and permanently attached antenna cable, 100 cm long, with SMA screw.

FAG55E-am	Wireless antenna, anthracite mat	Art. No. 30055144	48,80 €/pc.
FAG55E-pg	Wireless antenna, polar white glossy	Art. No. 30055145	48,80 €/pc.
FAG55E-pm	Wireless antenna, polar white mat	Art. No. 30055146	48,80 €/pc.
FAG55E-wg	Wireless antenna, pure white glossy	Art. No. 30055147	48,80 €/pc.

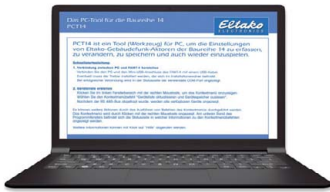

PCT14

The PC tool for Series 14 and 71

PCT14 is a PC-installed service program (PC Tool) to acquire, edit, save and reimport the settings of Eltako Series 14 and 71 actuators. It can be downloaded from the 'Software' section of our website. A card with the corresponding QR code is included with every FAM14 and FTS14KS.

Manuals and documents in further languages:
<http://eltako.com/redirect/PCT14>

PCT14	PC tool for Series 14 and 71	Included in the scope of supply of the FAM14 and FTS14KS
--------------	------------------------------	--

QUICK START GUIDE FOR SERIES 14 AND 71

After installing PCT14:

1. Establish connection between PC and FAM14, FTS14KS or DAT71.

Connect the PC and the mini-USB port with a USB cable. It may happen that the first connection automatically installs a driver. If the connection is successful, the status bar displays the used COM.

2. After installing the actuators, create a device list:

Right-click in the left window section to display the context menu. Select the command 'Update device list and read device memory' from the context menu. After the query for the RS485 bus, all the available devices are displayed. Other actions can be carried out by executing context menu commands. Right-click to display the context menu. The status line is located at the lower border of the program window and contains information on the context menu commands. Click on 'Help' for more information.

PCT14 PC Tool with export and import functions

PCT14 is capable of reading all sensor-actuator set-ups from Series 14 and Series 71 actuators fully automatically and exporting the data to the controller. The entries for the controller in the actuator are also generated here, which are then imported back into the Series 14 actuators.

Putting the controller on the fully set up Series 14 building radio is thus an easy exercise for the electrician. For data exchange a Windows PC/Notebook is needed.

PROCEDURE PCT14 DATA EXCHANGE WITH WIBUTLER PRO AND MINISAFE2

The software can be used with one of the following devices:

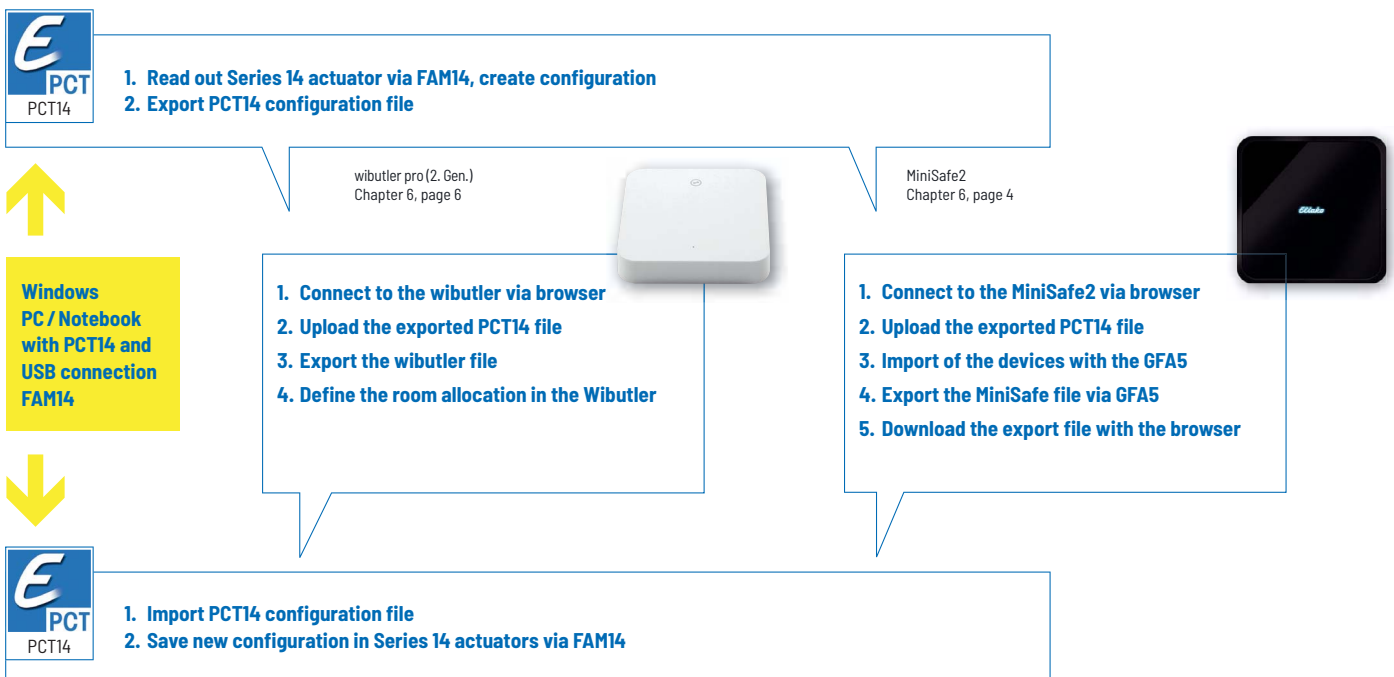



FSR14-4x



4-channel impulse switch with integrated relay function, 1 NO contact per channel 4 A/250 V AC, 230 V LED lamps up to 200 W, incandescent lamps 1000 watts, potential free from the power supply, with DX technology. Bidirectional. Only 0.1 watt standby loss.

Modular device for DIN-EN 60715 TH35 rail mounting. 1 module = 18 mm wide, 58 mm deep.

Connection to the Eltako-RS485 bus. Bus cross wiring and power supply with jumper.

Patented Eltako Duplex technology allows you to switch normally potential free contacts in zero passage switching when 230 V A/C voltage 50 Hz is switched. This drastically reduces wear. To achieve this, simply connect the N conductor to the terminal (N) and L to K(L). This results in an additional standby consumption of only 0.1 watt.

When all 4 relays of the FSR14-4x are switched on, a power of 0.7 watts is required.

If supply voltage fails, the device is switched off in defined mode.

The channels can be taught-in as ES and/or ER channel separately from each other.

Scene control:

Several channels of one or several FSR14-4x devices can be switched on or off in a scene by one of the four signals of a pushbutton with double rocker taught-in as a scene pushbutton.

Central commands can be sent using a wireless pushbutton and/or with a controller.

Use the rotary switches to teach-in the pushbuttons and test the 4 channels as required. For normal mode, the middle and lower rotary switches are then set to AUTO. With the upper rotary switch the EW time (0-120 seconds) is directly set for relays or the RV time (0-120 minutes) for impulse switches for all channels if necessary.

If **wireless motion/brightness sensors FBH (Master) and/or FBH (slave)** are taught-in, the switching threshold will be set with the upper rotary switch, separated for each channel, at which the lighting will be switched on or off. Settings of the upper rotary switch in accordance with operating instructions.

When wireless brightness sensors are taught-in, define the switching threshold separately for each channel using the top rotary switch. The switching threshold switches the lighting on or off depending on the brightness (from approx. 0lux in position 0 to approx. 50lux in position 120). A hysteresis of approx. 300 lux is permanently set for switch on/off.

An additionally set RV time is not taken into account.

Only one FBH (Master) or FAH can be taught-in per channel. However a FBH (Master) or FAH can be taught-in into several channels.

When wireless window/door contacts FTK or window handle sensors FFG7B are taught-in, different functions can be set with the middle rotary switch in position AUTO 1 to AUTO 4 and linked to maximum 116 FTKs:

AUTO 1 = window closed then output active.

AUTO 2 = window open then output active.

In settings AUTO 3 and AUTO 4 the FTKs taught-in to a single channel are linked automatically. With AUTO 3 all FTKs must be closed so that the N/O contact closes (e.g. for climate control). With AUTO 4 one open FTK is sufficient to close the N/O contact (e.g. for an alarm signal or to switch on the power supply for an extractor hood).

One or several FTKs can be taught-in in several channels to allow several simultaneous functions in each FTK.

After a power failure the link is restored by a new signal to the FTK and a signal on the next status message 15 minutes later.

An additionally set RV time is not taken into account.

Function with **wireless smoke alarm detectors FRW** or **water sensors** according to the operating instructions.

The LED below the upper function rotary switch performs during the teach-in process according to the operating instructions. It shows control commands by short flickering during operation.

Function rotary switches

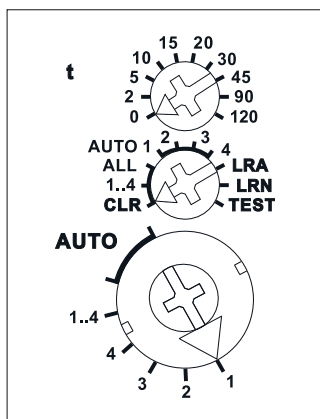

Standard setting ex works.

Further settings can be made using the PC Tool PCT14 (see page 1-5).



Manuals and documents in further languages:
<http://eltako.com/redirect/FSR14-4x>

Connection example page 1-50.
Technical data page 1-52.
Housing for operating instructions
GBA14 page 1-49.

FSR14-4x	RS485 bus actuator 4-channel impulse switch	Art. No. 30014001	65,40 €/pc.
-----------------	---	--------------------------	--------------------

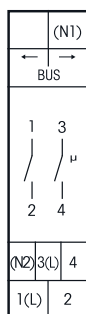

FSR14-2x



2-channel impulse switch with integrated relay function, 1+1 NO contacts potential free 16 A/250 V AC, 230 V LED lamps up to 400 W, incandescent lamps 2000 watts, with DX technology. Bidirectional. Only 0.1 watt standby loss.

Modular device for DIN-EN 60715 TH35 rail mounting. 1 module = 18 mm wide, 58 mm deep.

Connection to the Eltako-RS485 bus. Bus cross wiring and power supply with jumper.

Patented Eltako Duplex technology allows you to switch normally potential free contacts in zero passage switching when 230 V A/C voltage 50 Hz is switched. This drastically reduces wear. To achieve this, simply connect the N conductor to the terminal (N1) and L to 1(L) and/or N to (N2) and L to 3(L). This results in an additional standby consumption of only 0.1 watt.

If supply voltage fails, the switching state is retained.

When power is restored, the device is switched off in defined mode.

The channels can be taught-in as ES and/or ER channel separately from each other.

Scene control:

Several channels of one or several FSR14-2x devices can be switched on or off in a scene by one of the four signals of a pushbutton with double rocker taught-in as a scene pushbutton.

Central commands can be sent using a wireless pushbutton and/or with a controller.

Use the rotary switches to teach-in the pushbuttons and test the 2 channels as required. For normal mode, the middle and lower rotary switches are then set to AUTO. With the upper rotary switch the EW time (0-120 seconds) is directly set for relays or the RV time (0-120 minutes) for impulse switches for all channels if necessary.

If **wireless motion/brightness sensors FBH (Master) and/or FBH (slave)** are taught-in, the switching threshold will be set with the upper rotary switch, separated for each channel, at which the lighting will be switched on or off. Settings of the upper rotary switch in accordance with operating instructions.

When wireless brightness sensors are taught-in, define the switching threshold separately for each channel using the top rotary switch. The switching threshold switches the lighting on or off depending on the brightness (from approx. 0lux in position 0 to approx. 50 lux in position 120). A hysteresis of approx. 300 lux is permanently set for switch on/off. An additionally set RV time is not taken into account. Only one FBH (Master) or FAH can be taught-in per channel. However a FBH (Master) or FAH can be taught-in into several channels.

When wireless window/door contacts FTK or window handle sensors FFG7B are taught-in, different functions can be set with the middle rotary switch in position AUTO 1 to AUTO 4 and linked to maximum 116 FTKs:

AUTO 1 = window closed then output active.

AUTO 2 = window open then output active.

In settings AUTO 3 and AUTO 4 the FTKs taught-in to a single channel are linked automatically. With AUTO 3 all FTKs must be closed so that the N/O contact closes (e.g. for climate control). With AUTO 4 one open FTK is sufficient to close the N/O contact (e.g. for an alarm signal or to switch on the power supply for an extractor hood).

One or several FTKs can be taught-in in several channels to allow several simultaneous functions in each FTK.

After a power failure the link is restored by a new signal to the FTK and a signal on the next status message 15 minutes later.

An additionally set RV time is not taken into account.

Function with **wireless smoke alarm detectors FRW** or **water sensors** according to the operating instructions.

The LED below the upper function rotary switch performs during the teach-in process according to the operating instructions. It shows control commands by short flickering during operation.

Function rotary switches

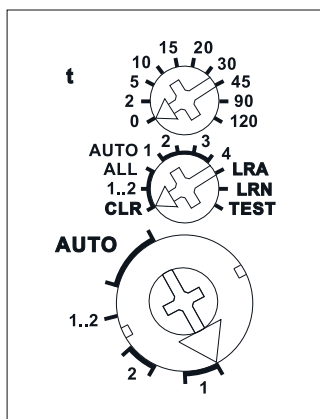

Standard setting ex works.

Further settings can be made using the PC Tool PCT14 (see page 1-5).



Manuals and documents in further languages:
<http://eltako.com/redirect/FSR14-2x>

Connection example page 1-50.
Technical data page 1-52.
Housing for operating instructions GBA14 page 1-49.

FSR14-2x	RS485 bus actuator 2-channel impulse switch	Art. No. 30014002	65,40 €/pc.
-----------------	---	--------------------------	--------------------

2-CHANNEL IMPULSE SWITCH WITH INTEGRATED RELAY FUNCTION WITH ACTIVE POWER MEASUREMENT FSR14M-2X

1-8

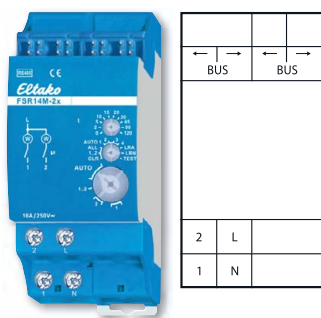

Function rotary switches

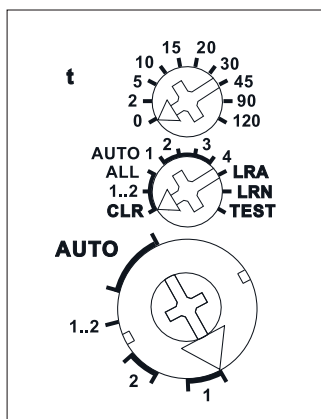

Standard setting ex works.

Further settings can be made using the PC Tool PCT14 (see page 1-5).



Manuals and documents in further languages:
<http://eltako.com/redirect/FSR14M-2x>

Connection example page 1-50.
Technical data page 1-52.
Housing for operating instructions
GBA14 page 1-49.

FSR14M-2x



2-channel impulse switch with integrated relay function and active power measurement. 1+1 NO contacts potential free 16 A/250 V AC, 230 V LED lamps up to 600 W, incandescent lamps 2000 watts. Bidirectional. Only 0.9 watt standby loss.

Modular device for DIN-EN 60715 TH35 rail mounting.

2 modules = 36 mm wide, 58 mm deep.

Supply voltage 230 V.

Connection to the Eltako-RS485 bus. Bus cross wiring and power supply with jumper.

The **instantaneous power** is measured separately for each channel and transferred to the bus - e.g. for transfer to an external computer or a controller - and also sent to the wireless network via the FAM14.

The maximum current as a sum over both contacts is 16A, so a fuse with a maximum of 16 A is required at L.

Zero passage switching to protect contacts and lamps.

If supply voltage fails, the switching state is retained.

When power is restored, the device is switched off in defined mode.

The channels can be taught-in as ES and/or ER channel separately from each other.

Scene control:

Several channels of one or several FSR14M-2x devices can be switched on or off in a scene by one of the four signals of a pushbutton with double rocker taught-in as a scene pushbutton.

Central commands can be sent using a wireless pushbutton and/or with a controller.

Use the rotary switches to teach-in the pushbuttons and test the 2 channels as required. For normal mode, the middle and lower rotary switches are then set to AUTO. With the upper rotary switch the EW time (0-120 seconds) is directly set for relays or the RV time (0-120 minutes) for impulse switches for all channels if necessary.

If **wireless motion/brightness sensors FBH (Master) and/or FBH (slave)** are taught-in, the switching threshold will be set with the upper rotary switch, separated for each channel, at which the lighting will be switched on or off. Settings of the upper rotary switch in accordance with operating instructions.

When wireless brightness sensors are taught-in, define the switching threshold separately for each channel using the top rotary switch. The switching threshold switches the lighting on or off depending on the brightness (from approx. 0lux in position 0 to approx. 50 lux in position 120). A hysteresis of approx. 300 lux is permanently set for switch on/off. An additionally set RV time is not taken into account. Only one FBH (Master) or FAH can be taught-in per channel. However a FBH (Master) or FAH can be taught-in into several channels.

When wireless window/door contacts FTK or window handle sensors FFG7B are taught-in, different functions can be set with the middle rotary switch in position AUTO 1 to AUTO 4 and linked to maximum 116 FTKs:

AUTO 1 = window closed then output active.

AUTO 2 = window open then output active.

In settings AUTO 3 and AUTO 4 the FTKs taught-in to a single channel are linked automatically. With AUTO 3 all FTKs must be closed so that the N/O contact closes (e.g. for climate control). With AUTO 4 one open FTK is sufficient to close the N/O contact (e.g. for an alarm signal or to switch on the power supply for an extractor hood).

One or several FTKs can be taught-in in several channels to allow several simultaneous functions in each FTK.

After a power failure the link is restored by a new signal to the FTK and a signal on the next status message 15 minutes later.

An additionally set RV time is not taken into account.

Function with **wireless smoke alarm detectors FRW** or **water sensors** according to the operating instructions.

The LED below the upper function rotary switch performs during the teach-in process according to the operating instructions. It shows control commands by short flickering during operation.

FSR14M-2x	RS485 bus actuator 2-channel impulse switch with integrated relay function with active power measurement	Art. No. 30014039	95,50 €/pc.
------------------	--	--------------------------	--------------------

RS485 BUS ACTUATOR 4-CHANNEL IMPULSE SWITCH WITH INTEGRATED RELAY FUNCTION FOR LED F4SR14-LED

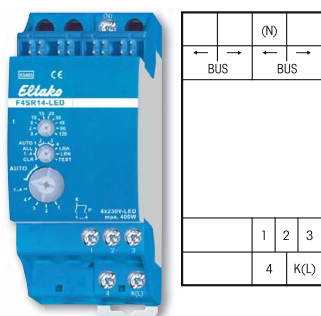

F4SR14-LED



1-9

4-channel impulse switch with integrated relay function, 1 NO contact per channel up to 8 A/250 V AC, 230 V LED lamps up to 400 W, incandescent lamps 1800 watts, potential free from the power supply, with DX technology. Bidirectional. Only 0.1 watt standby loss.

Modular device for DIN-EN 60715 TH35 rail mounting. 2 modules = 36 mm wide, 58 mm deep.

Connection to the Eltako-RS485 bus. Bus cross wiring and power supply with jumper.

230 V LED lamps can be switched up to 400 W and up to a maximum inrush current of 25 A/100 ms per NO contact.

Patented Eltako Duplex technology allows you to switch normally potential free contacts in zero passage switching when 230 V A/C voltage 50 Hz is switched. This drastically reduces wear. To achieve this, simply connect the N conductor to the terminal (N) and L to K(L). This results in an additional standby consumption of only 0.1 watt.

When all 4 relays of the F4SR14-LED are switched on, a power of 1 watt is required.

If supply voltage fails, the device is switched off in defined mode.

The channels can be taught-in as ES and/or ER channel separately from each other.

Scene control:

Several channels of one or several F4SR14-LED devices can be switched on or off in a scene by one of the four signals of a pushbutton with double rocker taught-in as a scene pushbutton.

Central commands can be sent using a wireless pushbutton and/or with a controller.

Use the rotary switches to teach-in the pushbuttons and test the 4 channels as required. For normal mode, the middle and lower rotary switches are then set to AUTO. With the upper rotary switch the EW time (0-120 seconds) is directly set for relays or the RV time (0-120 minutes) for impulse switches for all channels if necessary.

If **wireless motion/brightness sensors FBH (Master) and/or FBH (slave)** are taught-in, the switching threshold will be set with the upper rotary switch, separated for each channel, at which the lighting will be switched on or off. Settings of the upper rotary switch in accordance with operating manual.

When wireless brightness sensors are taught-in, define the switching threshold separately for each channel using the top rotary switch. The switching threshold switches the lighting on or off depending on the brightness (from approx. 0 lux in position 0 to approx. 50 lux in position 120). A hysteresis of approx. 300 lux is permanently set for switch on/off. An additionally set RV time is not taken into account. Only one FBH (Master) or FAH can be taught-in per channel. However a FBH (Master) or FAH can be taught-in into several channels.

When wireless window/door contacts FTK or window handle sensors FFG7B are taught-in, different functions can be set with the middle rotary switch in position AUTO 1 to AUTO 4 and linked to maximum 116 FTKs:

AUTO 1 = window closed then output active.

AUTO 2 = window open then output active.

In settings AUTO 3 and AUTO 4 the FTKs taught-in to a single channel are linked automatically. With AUTO 3 all FTKs must be closed so that the N/O contact closes (e.g. for climate control). With AUTO 4 one open FTK is sufficient to close the N/O contact (e.g. for an alarm signal or to switch on the power supply for an extractor hood).

One or several FTKs can be taught-in in several channels to allow several simultaneous functions in each FTK. After a power failure the link is restored by a new signal to the FTK and a signal on the next status message 15 minutes later.

An additionally set RV time is not taken into account.

Function with **wireless smoke alarm detectors FRW** or **water sensors** according to the operating instructions.

The LED below the upper function rotary switch performs during the teach-in process according to the operating instructions. It shows control commands by short flickering during operation.

Function rotary switches

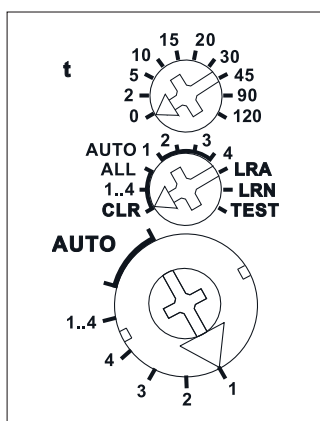

Standard setting ex works.

Further settings can be made using the PC Tool PCT14 (see page 1-5).



Manuals and documents in further languages:
<http://eltako.com/redirect/F4SR14-LED>

Connection example page 1-50.
Technical data page 1-52.
Housing for operating instructions
GBA14 page 1-49.

F4SR14-LED	RS485 bus actuator 4-channel impulse switch with integrated relay function for LED	Art. No. 30014076	76,30 € /pc.
-------------------	--	--------------------------	---------------------

RS485 BUS ACTUATOR 2-CHANNEL IMPULSE SWITCH WITH INTEGRATED RELAY FUNCTION NOISELESS FSR14SSR

1-10



Function rotary switches

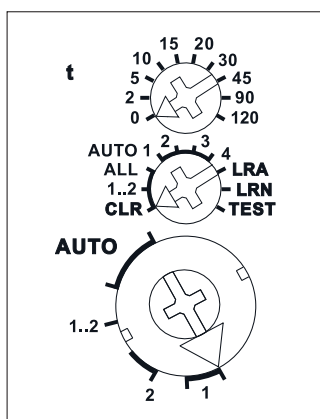

Standard setting ex works.

Further settings can be made using the PC Tool PCT14 (see page 1-5).



Manuals and documents in further languages:
<http://eltako.com/redirect/FSR14SSR>

Connection example page 1-50.
Technical data page 1-52.
Housing for operating instructions
GBA14 page 1-49.

FSR14SSR



Noiseless 2-channel impulse switch with integrated relay function, 230 V LED lamps up to 400 W, incandescent lamps 400 watts. 2 solid state relays not potential free. Bidirectional. Only 0.1 watt standby loss.

Modular device for DIN-EN 60715 TH35 rail mounting. 1 module = 18 mm wide, 58 mm deep.

Connection to the Eltako-RS485 bus. Bus cross wiring and power supply with jumper.

If both relays of the FSR14 are switched on, a power of 0.4 watts is required.

The rated switching capacity of 400 W is applied for one contact and also for the sum of the two contacts. The parallel connection of multiple devices to increase power is allowed.

From manufacturing date 12/17 with automatic overtemperature shutdown.

With a load < 1W a GLE must be switched parallel to the load.

If supply voltage fails, the device is switched off in defined mode.

The channels can be taught-in as ES and/or ER channel separately from each other.

Scene control:

Several channels of one or several FSR14SSR devices can be switched on or off in a scene by one of the four signals of a pushbutton with double rocker taught-in as a scene pushbutton.

Central commands can be sent using a wireless pushbutton and/or with a controller.

Use the rotary switches to teach-in the pushbuttons and test the 2 channels as required. For normal mode, the middle and lower rotary switches are then set to AUTO. With the upper rotary switch the EW time (0-120 seconds) is directly set for relays or the RV time (0-120 minutes) for impulse switches for all channels if necessary.

If **wireless motion/brightness sensors FBH (Master) and/or FBH (slave)** are taught-in, the switching threshold will be set with the upper rotary switch, separated for each channel, at which the lighting will be switched on or off. Settings of the upper rotary switch in accordance with operating instructions.

When wireless brightness sensors are taught-in, define the switching threshold separately for each channel using the top rotary switch. The switching threshold switches the lighting on or off depending on the brightness (from approx. 0 lux in position 0 to approx. 50 lux in position 120). A hysteresis of approx. 300 lux is permanently set for switch on/off. An additionally set RV time is not taken into account. Only one FBH (Master) or FAH can be taught-in per channel. However a FBH (Master) or FAH can be taught-in into several channels.

When wireless window/door contacts FTK or window handle sensors FFG7B are taught-in, different functions can be set with the middle rotary switch in position AUTO 1 to AUTO 4 and linked to maximum 116 FTKs:

AUTO 1 = window closed then output active.

AUTO 2 = window open then output active.

In settings AUTO 3 and AUTO 4 the FTKs taught-in to a single channel are linked automatically. With AUTO 3 all FTKs must be closed so that the N/O contact closes (e.g. for climate control). With AUTO 4 one open FTK is sufficient to close the N/O contact (e.g. for an alarm signal or to switch on the power supply for an extractor hood).

One or several FTKs can be taught-in in several channels to allow several simultaneous functions in each FTK.

After a power failure the link is restored by a new signal to the FTK and a signal on the next status message 15 minutes later.

An additionally set RV time is not taken into account.

Function with **wireless smoke alarm detectors FRW** or **water sensors** according to the operating instructions.

The LED below the upper function rotary switch performs during the teach-in process according to the operating instructions. It shows control commands by short flickering during operation.

FSR14SSR	RS485 bus actuator 2-channel impulse switch with integrated relay function noiseless	Art. No. 30014020	66,00 €/pc.
-----------------	--	--------------------------	--------------------

RS485 BUS ACTUATOR MULTIFUNCTION IMPULSE SWITCH WITH INTEGRATED RELAY FUNCTION FMS14



FMS14



1-11

Multifunction impulse switch with integrated relay function, 1+1 NO potential free 16 A/250 V AC, 230 V LED lamps up to 400 W, incandescent lamps 2000 W, with DX technology. Bidirectional. Only 0.1-0.6 watt standby loss.

Modular device for DIN-EN 60715 TH35 rail mounting.
1 module = 18 mm wide, 58 mm deep.

Connection to the Eltako-RS485 bus. Bus cross wiring and power supply with jumper. Patented Eltako Duplex technology allows you to switch normally potential free contacts in zero passage switching when 230 V A/C voltage 50 Hz is switched. This drastically reduces wear. To achieve this, simply connect the N conductor to the terminal (N) and L to K(L). This results in an additional standby consumption of only 0.1 watt.

Maximum current over both contacts 16 A for 230 V.

If supply voltage fails, the device is switched off in defined mode.

When both relays of the FMS14 are switched on, 0.6 watt are required.

The upper and the middle rotary switches are for teaching-in the sensors. In normal mode, the middle rotary switch is then set to AUTO and the bottom rotary switch to the required function:

- 2S** = Impulse switch with 2 NO contacts
- (2xS)** = 2-way impulse switch each with one NO relay
- WS** = Impulse switch with 1 NO contact and 1 NC contact (0.3 watt standby loss)
- SS1** = Impulse multi circuit switch 1+1 NO contacts for switching sequence 1
- SS2** = Impulse multi circuit switch 1+1 NO contacts for switching sequence 2
- SS3** = Impulse multi circuit switch 1+1 NO contacts for switching sequence 3
- GS** = Impulse group switch 1+1 NO contacts
- 2R** = Switching relay with 2 NO contacts
- WR** = Switching relay with 1 NO contact and 1 NC contact (0.3 watt standby loss)
- RR** = Switching relay (closed-circuit current relay) with 2 NC contacts (0.5 watt standby loss)
- GR** = Group relay 1+1 NO contacts

Switching sequence SS1: 0 - contact 1(K-1) - contact 2(K-2) - contact 1 + 2

Switching sequence SS2: 0 - contact 1 - contact 1 + 2 - contact 2

Switching sequence SS3: 0 - contact 1 - contact 1 + 2

Switching sequence GS: 0 - contact 1 - 0 - contact 2

GR: Relay with alternating closing contacts.

The LED below the upper function rotary switch performs during the teach-in process according to the operating instructions. It shows control commands by short flickering during operation.

Function rotary switches

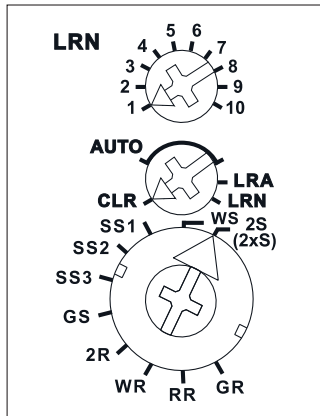

Standard setting ex works.

Further settings can be made using the PC Tool PCT14 (see page 1-5).



Manuals and documents in further languages:
<http://eltako.com/redirect/FMS14>

Connection example page 1-50.
Technical data page 1-52.
Housing for operating instructions
GBA14 page 1-49.

FMS14	RS485 bus actuator multifunction impulse switch with integrated relay function	Art. No. 30014003	57,50 €/pc.
--------------	--	--------------------------	--------------------



FUD14



Universal dimmer switch, Power MOSFET up to 400 W. Automatic lamp detection. Bidirectional. Only 0.3 watt standby loss. With adjustable minimum brightness or maximum brightness and dimming speed. With switching operation for light alarm clocks, children's rooms and snooze function. Also with light scene control and constant light regulation.

Modular device for DIN-EN 60715 TH35 rail mounting.

1 module = 18 mm wide, 58 mm deep.

The delivery includes a spacer DS14, 1 short jumper 1 module (up to 200 W load) and 1 long jumper 1.5 modules (from 200 W load with DS14 on the left side).

Universal dimmer switch for lamps up to 400 W, depending on ventilation conditions, dimmable 230 V LED lamps and dimmable energy saving lamps (ESL) are also dependent on the lamp electronics and the dimming technology, **see technical data page 1-52.**

Zero passage switching with soft ON and soft OFF to protect lamps.

Switching voltage 230 V. No minimum load.

The brightness level is stored on switch-off (memory).

In case of a power failure the switch position and the brightness stage are stored and may be switched on when the power supply is restored.

Automatic electronic overload protection and overtemperature switch-off.

Connection to the Eltako-RS485 bus. Bus cross wiring and power supply with jumper.

The upper rotary switch LA/LRN is first required for teach-in and defines in operation whether automatic lamp detection should be activated or special comfort positions:

AUTO allows all lamp types to be dimmed.

LC1 is a comfort position for dimmable 230 V LED lamps which cannot be dimmed down far enough in AUTO (phase cut-off) due to their design.

LC2 and **LC3** are comfort positions for dimmable 230 V LED lamps like LC1 but with different dimming curves.

LC4, LC5 and **LC6** are comfort positions for LED lamps such as AUTO but with different dimming curves.

EC1 is a comfort position for energy saving lamps which must be switched on at high voltage due to their design so that they can be dimmed down and switched back on safely when cold.

EC2 is a comfort position for energy saving lamps which cannot be switched back on in dimmed-down position due to their design. Therefore the memory is switched off in this position.

In positions LC1, LC2, LC3, EC1 and EC2 no inductive (wound) transformers may be used. In addition the maximum number of dimmable LED lamps may be lower than in AUTO position due to their design.

PCT is a position for special functions which are set up using the PC tool PCT14.

The minimum brightness (fully dimmed down) is adjustable **with the middle % rotary switch.**

The dimming speed is adjustable using the bottom dimming speed rotary switch.

The pushbuttons can be taught-in either as direction pushbuttons or universal pushbuttons:

When installed as a direction pushbutton, one side is then 'switch on and dim up' and the other side is 'switch off and dim down'. A double-click on the switch-on side activates automatic dim-up to full brightness at dim speed. A double click on the switch-off side activates the snooze function. The children's room function is implemented on the switch-on side. **As a universal pushbutton**, change the direction by briefly releasing the pushbutton.

For light scene control, constant light regulation, light alarm circuit, children's room circuit and sleep timer, refer to the operating instructions.

When the pushbutton is taught in as a staircase pushbutton, it is possible to retrieve a resettable staircase time switch function with RV = 2 minutes. Individual light scene pushbuttons can be used to retrieve brightness settings carried out during teach-in. A taught-in FAH can be used to implement a twilight switch. Switch-on can take place using up to 4 FBHs depending on motion and brightness.

The LED performs during the teach-in process according to the operating instructions.

It shows control commands by short flickering during operation.

Function rotary switches

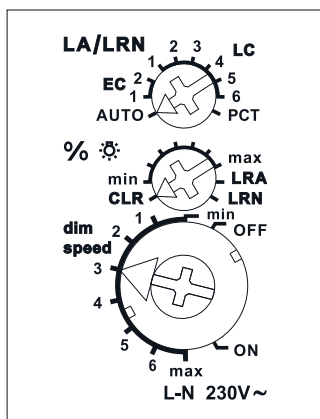

Standard setting ex works.

Further settings can be made using the PC Tool PCT14 (see page 1-5).



Manuals and documents in further languages:
<http://eltako.com/redirect/FUD14>

Connection example page 1-50.
Technical data page 1-52.
Housing for operating instructions
GBA14 page 1-49.

FUD14	RS485 bus universal dimmer switch	Art. No. 30014005	74,50 €/pc.
-------	-----------------------------------	-------------------	-------------

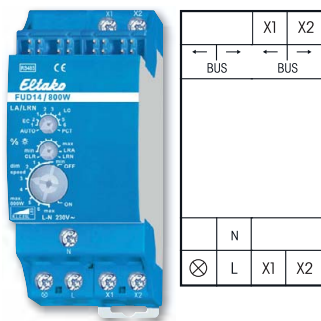

FUD14/800W

Universal dimmer switch, Power MOSFET up to 800 W. Automatic lamp detection. Only 0.3 watt standby loss. With adjustable minimum brightness or maximum brightness and dimming speed. With switching operation for light alarm clocks, children's rooms and snooze function. Also with light scene control and constant light regulation.

Modular device for DIN-EN 60715 TH35 rail mounting.
 2 modules = 36 mm wide, 58 mm deep.
 The delivery includes a spacer DS14, 2 short jumpers 1 module (up to 400 W load) and 1 long jumper 1.5 modules (from 400 W load with DS14 on the left side).

Universal dimmer switch for lamps up to 800 W, depending on ventilation conditions, dimmable 230 V LED lamps and dimmable energy saving lamps (ESL) are also dependent on the lamp electronics and the dimming technology, **see technical data page 1-52.**

Up to 3600 W with capacity enhancers FLUD14 at terminals X1 and X2.

Zero passage switching with soft ON and soft OFF to protect lamps.

Switching voltage 230 V. No minimum load.

The brightness level is stored on switch-off (memory).

In case of a power failure the switch position and the brightness stage are stored and may be switched on when the power supply is restored.

Automatic electronic overload protection and overtemperature switch-off.

Connection to the Eltako-RS485 bus. Bus cross wiring and power supply with jumper.

The upper rotary switch LA/LRN is first required for teach-in and defines in operation whether automatic lamp detection should be activated or special comfort positions:

AUTO allows all lamp types to be dimmed.

LC1 is a comfort position for dimmable 230 V LED lamps which cannot be dimmed down far enough in AUTO (phase cut-off) due to their design.

LC2 and LC3 are comfort positions for dimmable 230 V LED lamps like LC1 but with different dimming curves.

LC4, LC5 and LC6 are comfort positions for LED lamps such as AUTO but with different dimming curves.

EC1 is a comfort position for energy saving lamps which must be switched on at high voltage due to their design so that they can be dimmed down and switched back on safely when cold.

EC2 is a comfort position for energy saving lamps which cannot be switched back on in dimmed-down position due to their design. Therefore the memory is switched off in this position.

In positions LC1, LC2, LC3, EC1 and EC2 no inductive (wound) transformers may be used. In addition the maximum number of dimmable LED lamps may be lower than in AUTO position due to their design.

PCT is a position for special functions which are set up using the PC tool PCT14.

The minimum brightness (fully dimmed down) is adjustable **with the middle % rotary switch.**

The dimming speed is adjustable using the **bottom dimming speed rotary switch.**

The pushbuttons can be taught-in either as direction pushbuttons or universal pushbuttons:

When installed as a direction pushbutton, one side is then 'switch on and dim up' and the other side is 'switch off and dim down'. A double-click on the switch-on side activates automatic dim-up to full brightness at dim speed. A double click on the switch-off side activates the snooze function. The children's room function is implemented on the switch-on side.

As a universal pushbutton, change the direction by briefly releasing the pushbutton.

For light scene control, constant light regulation, light alarm circuit, children's room circuit and sleep timer, refer to the operating instructions.

When the pushbutton is taught in as a staircase pushbutton, it is possible to retrieve a resettable staircase time switch function with RV = 2 minutes. Individual light scene pushbuttons can be used to retrieve brightness settings carried out during teach-in. A taught-in FAH can be used to implement a twilight switch. Switch-on can take place using up to 4 FBHs depending on motion and brightness.

The LED performs during the teach-in process according to the operating instructions.

It shows control commands by short flickering during operation.

Function rotary switches

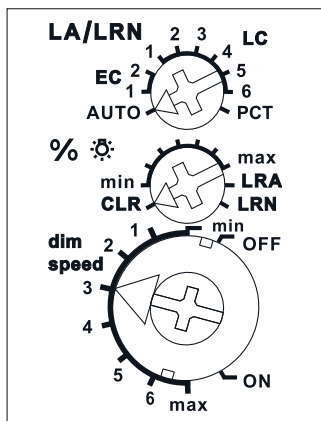

Standard setting ex works.

Typical connection

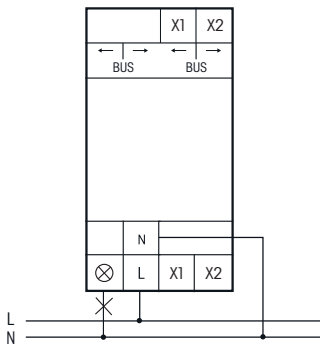

Further settings can be made using the PC Tool PCT14 (see page 1-5).

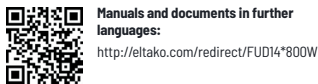

Manuals and documents in further languages:
http://eltako.com/redirect/FUD14*800W

Connection example page 1-50.
 Technical data page 1-52.
 Housing for operating instructions
 GBA14 page 1-49.

FUD14/800W	RS485 bus actuator universal dimmer switch up to 800 W	Art. No. 30014006	100,30 €/pc.
-------------------	--	--------------------------	---------------------

RS485 BUS CAPACITY ENHANCER FOR UNIVERSAL DIMMER SWITCH FUD14/800W FLUD14

1-14



FLUD14



Capacity enhancer for universal dimmer switch FUD14/800 W, Power MOSFET up to 400 W. Standby loss 0.1 watt only.

Modular device for DIN EN 60715 TH35 rail mounting.
1 module = 18 mm wide, 58 mm deep.

Capacity enhancers FLUD14 can be connected to the universal dimming actuator FUD14/800W. By this the switching capacity **for one lamp** will be increased up to 200 W or alternatively **for additional lamps** up to 400 W per each capacity enhancer.

The two circuits to increase capacity can be created at the same time using several FLUD14s.
Supply voltage 230 V. No minimum load.

Automatic electronic overload protection and over-temperature switch-off.

The lamp type of a capacity enhancer FLUD14 in the 'Capacity increase with additional lamps' may deviate from the lamp type of the universal dimmer switch FUD14/800W.

It is therefore possible to mix capacitive and inductive loads.

Function rotary switch

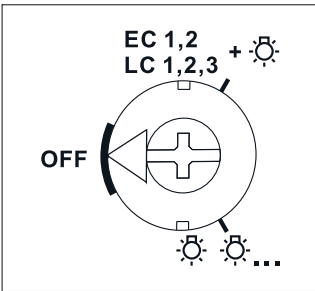

Standard setting ex factory.

The switching mode **"one lamp"** (☼) or **"additional lamps"** (☼☼) is set with a rotary switch on the front.

This setting must be same as the actual installation, otherwise there is a risk of destruction of the electronics.

QR code and manual link: <http://eltako.com/redirect/FLUD14>

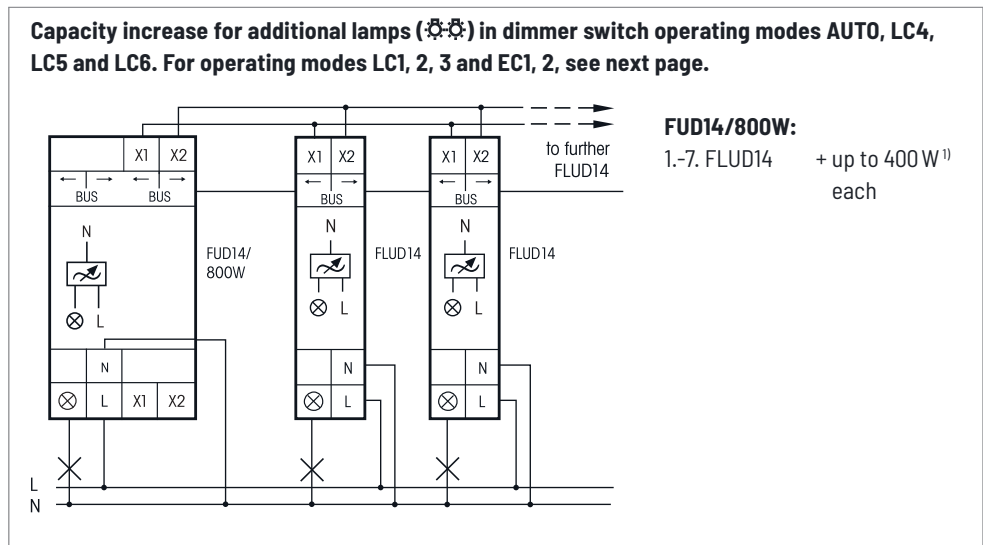
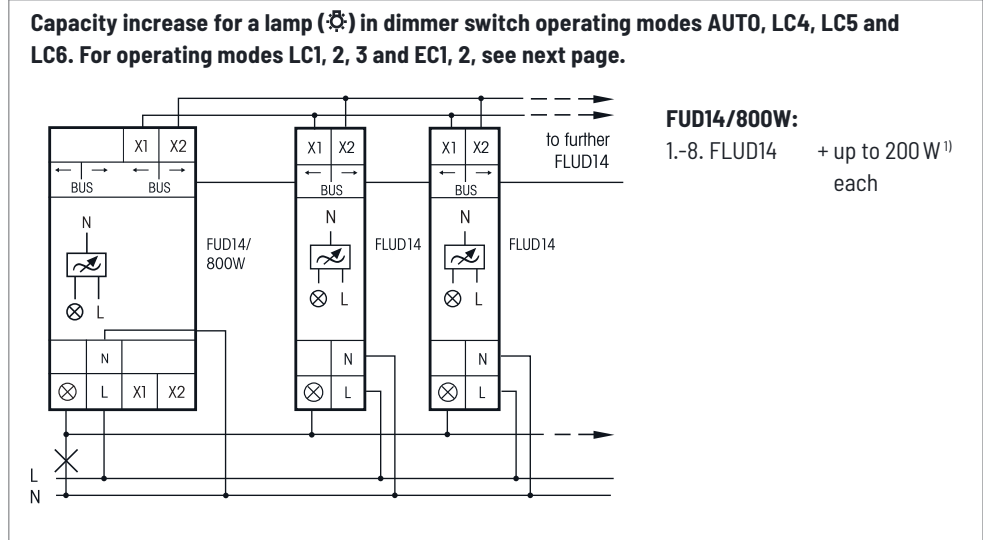

¹⁾ Ventilation clearance of 1/2 module to adjacent devices must be maintained.

Housing for operating instructions GBA14 page 1-49.

FLUD14	RS485 bus capacity enhancer for universal dimmer switch FUD14/800W	Art. No. 30014007	68,00 €/pc.
---------------	--	--------------------------	--------------------

FLUD14



Function rotary switch

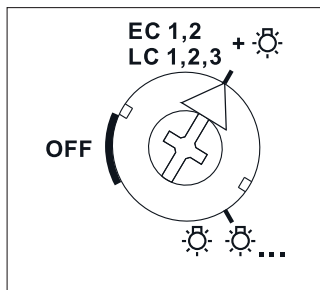

Standard setting ex factory.

Capacity increase with capacity enhancers FLUD14 for dimmable 230 V LED lamps and dimmable energy saving lamps ESL in comfort settings LC1, LC2, LC3 EC1 and EC2.

Also for capacity increase with additional lamps.

Otherwise there is a risk of destruction of the electronics.



Manuals and documents in further languages:
<http://eltako.com/redirect/FLUD14>

Housing for operating instructions GBA14 page 1-49.

Capacity increase with capacity enhancers FLUD14 for dimmable 230 V LED lamps and dimmable energy saving lamps ESL in comfort settings LC1, LC2, LC3, EC1 and EC2.

Capacity increase of a lamp in settings LC1, 2, 3 and EC1, 2

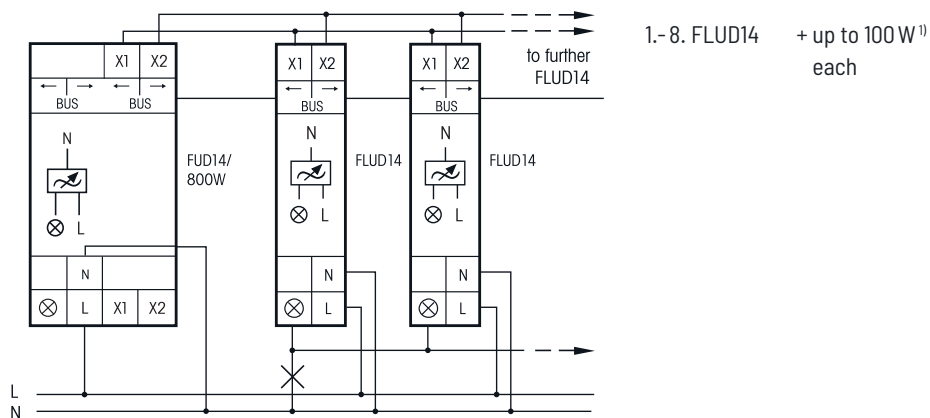

Capacity increase with additional lamps in settings LC1, 2, 3 and EC1, 2

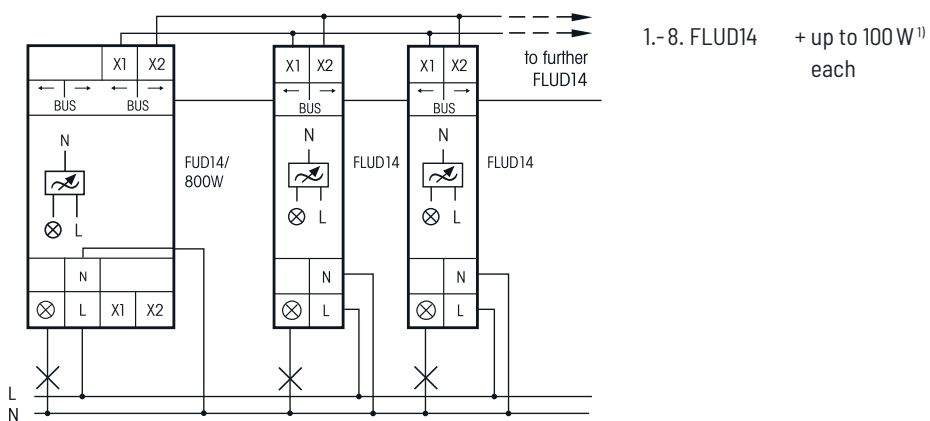

¹⁾ Ventilation clearance of 1/2 module to adjacent devices must be maintained.

FLUD14	RS485 bus capacity enhancer for universal dimmer switch FUD14/800W	Art. No. 30014007	68,00 €/pc.
---------------	--	--------------------------	--------------------

RS485 BUS ACTUATOR DIMMER SWITCH CONTROLLER FOR ELECTRONIC BALLAST 1-10 V FSG14/1-10V

1-16

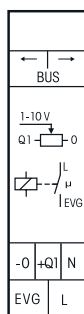

Function rotary switches

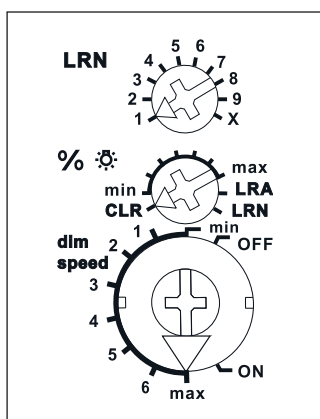

Standard setting ex works.

Typical connection

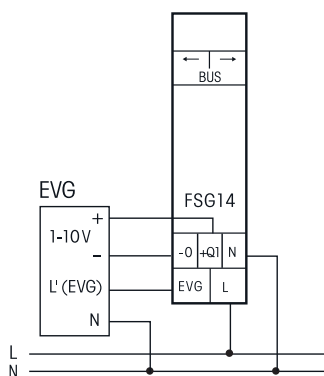

Further settings can be made using the PC Tool PCT14 (see page 1-5).



Manuals and documents in further languages:
http://eltako.com/redirect/FSG14*1-10V

Connection example page 1-50.
Technical data page 1-52.
Housing for operating instructions
GBA14 page 1-49.

FSG14/1-10V



Dimmer switch controller for electronic ballast 1-10 V, 1 NO contact not potential free 600 VA and 1-10 V control output 40 mA. Bidirectional. Only 0.5 watt standby loss. With adjustable minimum brightness and dimming speed. With light scene control and constant light regulation.

Modular device for DIN-EN 60715 TH35 rail mounting.

1 module = 18 mm wide, 58 mm deep.

State-of-the-art hybrid technology combines advantages of nonwearing electronic control.

Zero passage switching to protect contacts.

The power consumption of the 12 V DC power supply is only 0.1 W.

Also adapted for LED driver with 1-10 V passive interface, without voltage source up to 0.6 mA, above this value an additional voltage source is necessary.

The brightness level is stored on switch-off (memory).

In case of a power failure the switch position and the brightness stage are stored and may be switched on when the power supply is restored.

Connection to the Eltako-RS485 bus. Bus cross wiring and power supply with jumper.

The minimum brightness (fully dimmed) is adjustable with the % rotary switch.

The dimming speed is adjustable using the dimming speed rotary switch.

The load is switched on and off by a bistable relay at output EVG. Switching capacity for fluorescent lamps or LV halogen lamps with EGV 600 VA.

By using a bistable relay coil power loss and heating is avoided even in the on mode.

After installation, wait for short automatic synchronisation before the switched consumer is connected to the mains.

The pushbuttons can be taught-in either as direction pushbuttons or universal pushbuttons:

As a direction pushbutton, press up is brighter and press down is darker respectively above short pressing means switch ON and below short pressing switch OFF. A double click above activates automatic updimming until full brightness with dim speed. A double click below activates snooze function. The children's room function will be realized with the upper switch.

As a universal pushbutton, change the direction by briefly releasing the pushbutton.

With switching operation for children's rooms and snooze function.

Switching for light alarm clocks: A wireless signal of a time clock which was taught-in accordingly starts the wake up function by switching on the light at the lowest brightness level and dims up slowly until the maximum level is reached. The dimming process is stopped by tapping briefly (e.g. on a hand-held transmitter).

Switching operation for children's rooms: If the light is switched on by holding down the pushbutton (universal pushbutton or direction pushbutton above), it starts at the lowest brightness level after approx. 1 second and dims up slowly as long as the pushbutton is held down. The last saved brightness level is not modified.

Snooze function (universal pushbutton or direction pushbutton below): With a double impulse the lighting is dimmed down from the current dimming position to the minimum brightness level and switched off.

The current dimming position as well as the adjustable minimum brightness level determine the dimming time (max. = 60 minutes) which can be reduced as required. It can be switched off at any time by short-time control commands during the lighting is dimmed down.

The LED below the upper function rotary switch performs during the teach-in process according to the operating instructions. It shows control commands by short flickering during operation.

FSG14/1-10V	RS485 bus actuator dimmer switch controller for electronic ballast 1-10 V	Art. No. 30014008	69,90 € / pc.
--------------------	---	--------------------------	----------------------

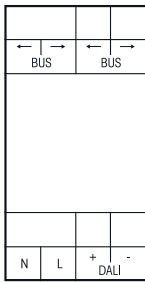

FDG14



RS485 bus DALI gateway for DIN-EN 60715 TH35 rail mounting, bidirectional. Only 1 watt standby loss.

Modular device for DIN-EN 60715 TH35 rail mounting. 2 modules = 36 mm wide, 58 mm deep.
Connection to the Eltako-RS485 bus. Bus cross wiring and power supply with jumper.
Operation in conjunction with FAM14.

Power supply 230 V at terminals N and L.

16 V DC/130 mA can be connected to the DALI terminals +/- for up to 64 DALI devices.

The gateway FDG14 controls DALI devices with EnOcean wireless transmitters via the FAM14.

As of production week 14/16 **Groups 0-15** can be controlled and the **broadcast command** can be sent. In addition **DALI scenes 0-15** can be controlled.

DALI installations, which are to be fully controlled with the FDG14, must be configured in groups 0-15.

FDG14 internally saves the dimming value for each of the groups 0-15 and supplies this value as feedback.

The same feedback telegrams are generated as for an FUD14. The FDG14 occupies 16 BR14 device addresses.

The feedbacks of the device addresses correspond to the dimming values of the DALI groups 0-15 in ascending order. Feedbacks can be converted by the PCT14 for each individual group of dimming value telegrams

(%) to pushbutton telegrams (ON/OFF). Feedbacks can then control BR14 actuators. The FDG14 fulfils the

function of the DALI master and the DALI power supply. The rotary switches can only teach in pushbuttons

for groups 0-8 and DALI scenes 0-9. Activation telegrams for groups 9-15 and scenes 10-15 are only possible

by entries in PCT14.

As of Production Week 30/19, the FDG14 can be used as a single-channel device '**FDG14-Broadcast**'. This is

defined when the device address is issued.

Important: Wireless pushbuttons always need to be double-clicked when they are taught-in manually in

the FDG14. CLR only needs a single click.

A direction pushbutton or universal pushbutton with identical ID and identical pushbutton can be taught in

several times in different groups. The group last selected is always valid. Therefore, a pushbutton can either

switch only one group or broadcast to all groups.

One FBH per group can also be taught in. With a manual teach-in this always acts dependent on brightness.

With PCT14 you can also set the brightness threshold.

The delay time for switch-off after no motion is detected can be set together in minutes (1 ... 60) for the FBH

devices of all groups. The default is 3 minutes.

Function rotary switches

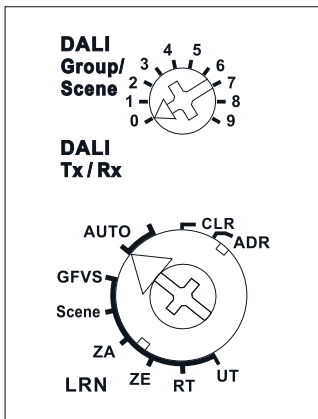

Standard setting ex works.

Further settings can be made using the PC Tool PCT14 (see page 1-5).



Manuals and documents in further languages:
<http://eltako.com/redirect/FDG14>

Housing for operating instructions
 GBA14 page 1-49.

FDG14	RS485 bus DALI gateway for rail mounting	Art. No. 30014047	95,60 €/pc.
--------------	--	--------------------------	--------------------

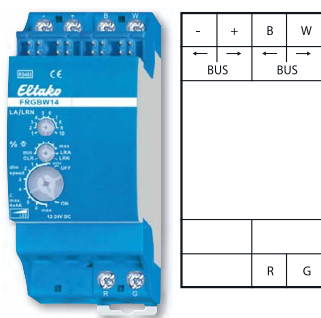

FRGBW14



PWM dimmer switch with 4 channels for LED 12-24 V DC, each up to 4 A. Adjustable minimum brightness and dimming speed. With snooze function and light alarm circuit. Additionally with light scene control via controller or with wireless pushbuttons. Standby loss only 0.1 watt.

Modular device for DIN-EN 60715 TH35 rail mounting.
2 modules = 36 mm wide, 58 mm deep.

Connection to the Eltako-RS485 bus. Bus cross wiring and power supply with jumper.

The set brightness level remains stored when switched off (memory).

In case of a power failure, the switch position and brightness level are saved and switched on when the power supply is restored.

Automatic electronic overload protection and overtemperature shutdown.

The upper rotary switch is only required for teach-in.

Use the middle % rotary switch to set the minimum brightness (fully dimmed).

Use the lower dimming speed rotary switch to set the dimming speed.

The pushbuttons can either be taught in as direction pushbuttons or universal pushbuttons: as direction pushbutton, one side is 'switch on and dim up'; the other side is 'switch off and dim down'. Double-click on the switch-on side to trigger automatic dim up to full brightness at dimming speed. Double-click on the switch-off side to trigger the snooze function. **As universal pushbutton**, change the direction by briefly releasing the pushbutton.

FHB wireless motion/brightness sensors can be taught in as master or slave.

FAH wireless brightness sensors can be taught in for switch-off dependent on brightness or as a twilight switch.

Light scene control, light alarm circuit and snooze function as described in the operating instructions.

The LED accompanies the teach-in process as described in the operating instructions and indicates control commands by briefly flickering during operation.

Function rotary switches

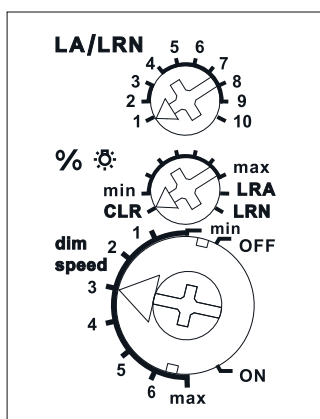

Standard setting ex works.

Further settings can be made using the PC Tool PCT14 (see page 1-5).



Manuals and documents in further languages:
<http://eltako.com/redirect/FRGBW14>

Connection example page 1-50.
Technical data page 1-52.
Housing for operating instructions
GBA14 page 1-49.

FRGBW14	RS485 bus wireless actuator PWM dimmer switch for LED	Art. No. 30014068	110,60 €/pc.
----------------	--	--------------------------	---------------------



Function rotary switches

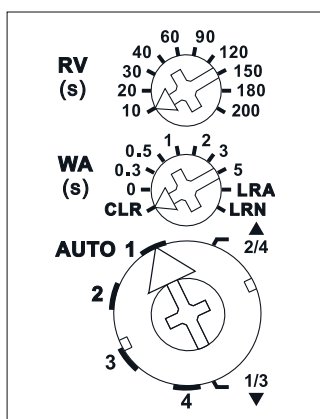

Standard setting ex works.

Further settings can be made using the PC Tool PCT14 (see page 1-5).



Manuals and documents in further languages:
<http://eltako.com/redirect/FSB14>

Connection example page 1-50.
 Technical data page 1-52.
 Housing for operating instructions
 GBA14 page 1-49.

FSB14



Switch actuator for shading elements and roller shutters with 2 channels for two 230 V motors. 2+2 NO contact 4 A/250 V AC, potential free from power supply 12 V. Bidirectional. Only 0.1 watt standby loss.

Modular device for DIN-EN 60715 TH35 rail mounting. 1 module = 18 mm wide, 58 mm deep.

Connection to the Eltako-RS485 bus. Bus cross wiring and power supply with jumper.

Zero passage switching to protect contacts and motors.

A motor is connected to 1, 2 and N; a second motor may be connected to 3, 4 and N.

If both relays of the FSB14 are switched on, a power of 0.4 watts is required.

If supply voltage fails, the device is switched off in defined mode.

The pushbuttons can be taught-in either as direction switches or universal switches:

Local control with universal pushbuttons: Each impulse causes the FSB14 to change its position in the UP-Stop-DOWN-Stop sequence.

Local control with direction pushbutton: A top impulse by pushbutton directly activates the 'UP'

switch position. A bottom impulse by pushbutton directly activates the 'DOWN' switch position.

A further impulse from one of the two pushbuttons stops the sequence immediately.

Central control dynamic without priority: A control signal from a pushbutton which was taught-in as a central control pushbutton without priority directly activates the switch position 'Up' with a scanning pulse up and the switch position 'Down' with a scanning pulse down. Without priority because this function can be overridden by other control signals.

Central control dynamic with priority: A control signal of min. 2 seconds from a pushbutton which was taught-in as a central control push-button with priority directly activates the switch position 'Up' (press top) and the switch position 'Down' (press bottom). With priority because these control signals cannot be overridden by other (local) control signals **until** the central control signal is cancelled by pressing again the central control pushbutton 'Up' or 'Down'.

The switch position 'up' or 'down' and the priority are specifically activated with a control signal, e.g. from a FSM61 taught-in with priority as a central pushbutton. With priority because these control signals cannot be overridden by other control signals **until** the central command is cancelled by the termination of the control signal.

Shading scene control: With a control signal of a pushbutton with double rocker taught-in as a scene pushbutton or automatically by an additional taught-in wireless-outdoor-brightness sensor, up to 4 previously filed elapse times can be accessed.

With control via controller, operating commands for up and down with the exact travel time information can be started. As the actuator reports the exact elapsed time after each activity, even when driving was triggered by a pushbutton, the position of the shading is always displayed correctly in an app. Upon reaching the end positions above and below the position is automatically synchronized.

Function rotary switch below

AUTO 1 = In this position, the **local advanced automatic reversing system for Venetian blinds** is activated. When a universal pushbutton or a direction pushbutton are used for control a double impulse activates a slow rotation in the opposite direction, which can be stopped with a further impulse. **AUTO 2**

= In this position, the local advanced automatic reversing system for Venetian blinds is completely switched off. **AUTO 3** = In this position, the local pushbuttons act static at first, thus, allow **reversal of Venetian blinds** by operating pushbuttons. They only switch to dynamic after 0.7 seconds continuous operation. **AUTO 4** = In this position, the local pushbuttons act only static (ER function). The time delay RV (wiping time) of the upper rotary switch is active. Central control is not possible.

▲▼ = ▲(UP) and ▼(DOWN) of the lower rotary switch are the positions for manual control. Manual control has priority over all other control commands.

WA = Automatic reversal for Venetian blinds and awnings is controlled by the middle rotary switch. 0 = OFF, otherwise from 0.3 to 5 seconds ON with the selected reversal time. In this case, it is only for DOWN that the direction is reversed on time-out of the time lag selected by the top rotary switch, e.g. to extend awnings or set Venetian blinds to a defined position. A LED is located behind the RV-rotary switch to show the reversal time.

RV = The time delay (delay time RV) is set by the top rotary switch. If the FSB14 is in the UP or DOWN position the selected delay time runs (elapses); at time-out the device changes automatically to STOP. Therefore, the time delay must be chosen at least as long as the shading element or roller shutter will need to move from one limit position to the other.

The LED indication for the delay time RV is located behind the rotary switch RV.

When one or several wireless window/door contacts FTK or window handle sensors FFG7B are taught-in, a lock-out protection is set up while the door is open and disables a Central Down command.

The LED below the upper function rotary switch performs during the teach-in process according to the operating instructions. It shows control commands by short flickering during operation.

FSB14	RS485 bus actuator for shading elements and roller shutters 230 V motor	Art. No. 30014004	64,90 € /pc.
--------------	---	--------------------------	---------------------

RS485 BUS ACTUATOR FOR SHADING ELEMENTS AND ROLLER SHUTTERS 12-24 V DC

FSB14/12-24V DC

1-20

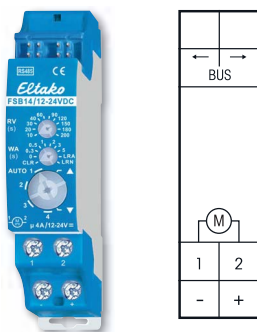

FSB14/12-24V DC



Switch actuator for shading elements and roller shutters for one 12-24 V DC motor. 1+1 NO contact 4 A/12-24 V DC, potential free from power supply 12 V. Bidirectional. Only 0.1 watt standby loss.

Modular device for DIN-EN 60715 TH35 rail mounting. 1 module = 18 mm wide, 58 mm deep.

Connection to the Eltako RS485 bus. Bus cross wiring and power supply with jumper.

The DC voltage for the motor is connected to terminals - and +, the DC motor to terminals 1 and 2. If relays of the FSB14 are switched on, a power of 0.4 watts is required. If supply voltage fails, the device is switched off in defined mode.

The pushbuttons can be taught-in either as direction switches or universal switches:

Local control with universal pushbutton: Each scanning pulse changes the switch position in the sequence 'Up, Stop, Down, Stop'. **Local control with direction pushbutton:** Each scanning pulse up activates the switch position 'Up'. A scanning pulse down, on the contrary, activates the switch position 'Down'. The next scanning pulse in the same direction interrupts the sequence immediately. However, a scanning pulse in the opposite direction stops and then switches over to the opposite direction after a pause of 500 ms.

Central control dynamic without priority: With a control signal from a button taught-in as a central control button without priority, the switching position 'up' at the top or 'down' at the bottom is specifically activated. No priority because this function can be overridden by other control signals. **Central control dynamic with**

priority: A control signal of min. 2 seconds from a pushbutton which was taught-in as a central control pushbutton with priority directly activates the switch position 'Up' (press top) and the switch position 'Down' (press bottom). With priority because these control signals cannot be overridden by other (local) control signals until the central control signal is cancelled by pressing again the central control pushbutton 'Up' or 'Down'. The switch position 'up' or 'down' and the priority are specifically activated with a control signal, e.g. from a FSM61 taught-in with priority as a central pushbutton. With priority because these control signals cannot be overridden by other control signals until the central command is cancelled by the termination of the control signal. **Shading scene control:** Up to 4 saved 'Down' running times are retrievable using the control signal of a pushbutton and double rocker taught-in as a scene pushbutton. **With control**

via controller, operating commands for up and down with the exact travel time information can be started. As the actuator reports the exact elapsed time after each activity, even when driving was triggered by a pushbutton, the position of the shading is always displayed correctly in an app. Upon reaching the end positions above and below the position is automatically synchronized. **Function rotary switch be-**

low: **AUTO 1** = In this position, the **local advanced automatic reversing system for Venetian blinds** is activated. When a universal pushbutton or a direction pushbutton are used for control a double impulse activates a slow rotation in the opposite direction, which can be stopped with a further impulse. **AUTO 2** = In this position, the local advanced automatic reversing system for Venetian blinds is completely switched off. **AUTO 3** = In this position, the local pushbuttons act static at first, thus, allow **reversal of Venetian blinds** by operating pushbuttons. They only switch to dynamic after 0.7 seconds continuous operation. **AUTO 4** = In this position, the local pushbuttons act only static (ER function). The time delay RV (wiping time) of the upper rotary switch is active. Central control is not possible.

▲▼ = ▲(UP) and ▼(DOWN) of the lower rotary switch are the positions for manual control. **Manual control** has priority over all other control commands.

WA = Automatic reversal for Venetian blinds and awnings is controlled by the middle rotary switch. 0 = OFF, otherwise from 0.3 to 5 seconds ON with the selected reversal time. In this case, it is only for DOWN that the direction is reversed on time-out of the time lag selected by the top rotary switch, e.g. to extend awnings or set Venetian blinds to a defined position. A LED is located behind the RV-rotary switch to show the reversal time.

RV = The time delay (delay time RV) is set by the top rotary switch. If the FSB14 is in the UP or DOWN position the selected delay time runs (elapses); at time-out the device changes automatically to STOP. Therefore, the time delay must be chosen at least as long as the shading element or roller shutter will need to move from one limit position to the other.

The LED indication for the delay time RV is located behind the rotary switch RV.

When one or several wireless window/door contacts FTK or window handle sensors FFG7B are taught-in, a lock-out protection is set up while the door is open and disables a Central Down command.

The LED below the upper function rotary switch performs during the teach-in process according to the operating instructions. It shows control commands by short flickering during operation.

Function rotary switches

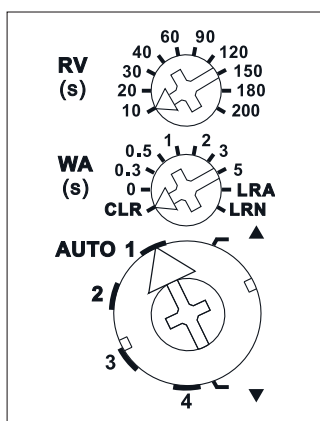

Standard setting ex works.

Further settings can be made using the PC Tool PCT14 (see page 1-5).



Manuals and documents in further languages:
http://eltako.com/redirect/FSB14*12-24V_DC

Connection example page 1-50.
Technical data page 1-52.
Housing for operating instructions
GBA14 page 1-49.

FSB14/ 12-24V DC	RS485 bus actuator for shading elements and roller shutters 12-24 V DC motor	Art. No. 30014079	61,00 €/pc.
-----------------------------	--	--------------------------	--------------------



FMZ14



Multifunction time relay with 10 functions, 1 CO contact potential free 10 A/250 V AC, 230 V LED lamps up to 400 W, incandescent lamps 2000 watts*, with DX technology. Bidirectional. Only 0.4 watt standby loss.

Modular device for DIN-EN 60715 TH35 rail mounting.
1 module = 18 mm wide, 58 mm deep.

Connection to the Eltako-RS485 bus. Bus cross wiring and power supply with jumper.

Wireless window contacts (FTK) at opened windows with the function NO or NC can be taught-in. If a direction switch is taught-in, a function (e.g. TI) can be started using the top switch (START) and stopped with the bottom switch (STOP).

Patented Eltako Duplex technology allows you to switch normally potential free contacts in zero passage switching when 230 V A/C voltage 50 Hz is switched. This drastically reduces wear. To achieve this, simply connect the N conductor to the terminal (N) and L to K(L). This results in an additional standby consumption of only 0.1 watt.

If supply voltage fails, the two contacts switch off. When power is restored, contact 1 closes.

Time setting between 0.5 second and 10 hours.

Teach-in takes place **using the top and middle rotary switches** and then the time is set.

T is the time base and xT the multiplier.

The function is selected **using the bottom rotary switch:**

- RV** = off delay
- AV** = operate delay
- TI** = clock generator starting with impulse
- TP** = clock generator starting with pause
- IA** = impulse controlled operate delay (e.g. automatic door opener)
- EW** = fleeting NO contact
- AW** = fleeting NC contact
- ARV** = operate and release delay
- ON** = Permanent ON
- OFF** = Permanent OFF

The LED below the upper function rotary switch performs during the teach-in process according to the operating instructions. It shows control commands by short flickering during operation.

* The maximum load can be used starting at a delay time or clock cycle of 5 minutes.
The maximum load will be reduced for shorter times as follows: up to 2 seconds 15%, up to 2 minutes 30%, up to 5 minutes 60%.

Function rotary switches

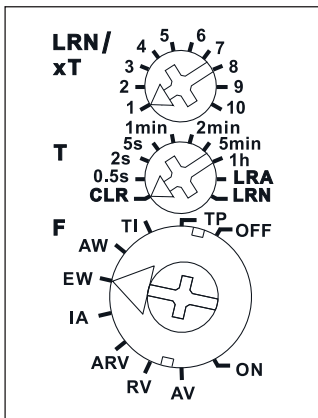

Standard setting ex works.

Further settings can be made using the PC Tool PCT14 (see page 1-5).



Manuals and documents in further languages:
<http://eltako.com/redirect/FMZ14>

Connection example page 1-50.
Technical data page 1-52.
Housing for operating instructions
GBA14 page 1-49.

FMZ14	RS485 bus actuator Multifunction time relay	Art. No. 30014009	55,40 € /pc.
--------------	--	--------------------------	---------------------

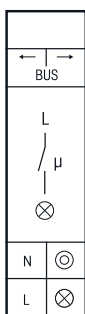

Function rotary switches

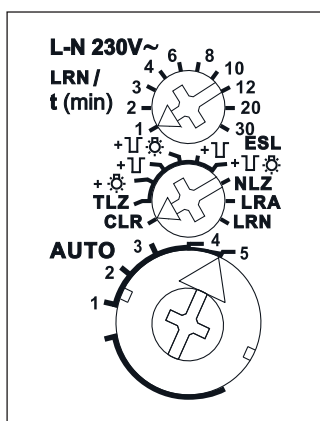

Standard setting ex works.

Further settings can be made using the PC Tool PCT14 (see page 1-5).



Manuals and documents in further languages:
<http://eltako.com/redirect/FTN14>

Connection example page 1-50.
 Technical data page 1-52.
 Housing for operating instructions
 GBA14 page 1-49.

FTN14



Staircase off-delay timer, 1 NO contact not potential free 16 A/250 V AC, 230 V LED lamps up to 400 W, incandescent lamps up to 2000 watts, switch-off early warning and switchable pushbutton permanent light. Also for energy saving lamps ESL up to 200 Watt. Bidirectional. Only 0.2 watt standby loss.

Modular device for DIN-EN 60715 TH35 rail mounting.

1 module = 18 mm wide, 58 mm deep.

Connection to the Eltako-RS485 bus. Bus cross wiring and power supply with jumper.

Switching voltage 230 V.

Zero passage switching to protect contacts and consumers.

If a power failure occurs, the switching state is retained. The time lapse to switch off starts when the power supply is restored.

In addition to the bus control input, this staircase off-delay timer can also be controlled locally by a conventional 230 V control switch. Glow lamp current up to 5 mA, dependent on the ignition voltage of the glow lamps.

The upper rotary switch LRN is required for teach-in. Then the off-delay 1 to 30 minutes can be set. Wireless pushbuttons and/or wireless motion-brightness sensors FBH will be taught-in **with the middle rotary switch** in the setting LRN, of which one or more are central control pushbuttons. The required function of this staircase off-delay timer can then be selected:

NLZ = off-delay timer with adjustable operate delay

TLZ = staircase time switch

ESL = staircase time switch for energy saving lamps ESL

+ = with pushbutton permanent light (only TLZ)

+ = with switch-off early warning (TLZ + ESL)

+ = with pushbutton permanent light and switch-off early warning (TLZ + ESL)

If the permanent light function is switched on, the function can be activated by pressing the pushbutton for longer than 1 second. This function switches off automatically after 60 minutes or by pressing the pushbutton for longer than 2 seconds.

If the switch-off early warning is switched on, the light starts to flicker approx. 30 seconds before time-out. This is repeated three times at decreasing time intervals.

If both switch-off early warning and pushbutton permanent light are switched on, switch-off early warning is activated before automatic switch-off of the permanent light.

A response delay (AV delay) can be set **with the lower rotary switch** at setting NLZ or when controlled with a switch. Setting AUTO1 = 1s, AUTO2 = 30s, AUTO3 = 60s, AUTO4 = 90s and AUTO5 = 120s (clockwise). Also permanent light function can be set manually.

But if you activate by pressing a button at NLZ, the device switches on when pressed once and the time lapse to switch-off starts when pressed twice.

When teaching-in **wireless motion/brightness sensors FBH**, the switching threshold is defined on the last FBH taught-in to switch the light on/off depending on the brightness – provided motion is detected. The off delay set on the FTN14 is prolonged by a setting of 1 minute fixed in the FBH.

When teaching-in **window/door contacts FTK**, a NC or NO can be taught-in as required. Accordingly, the timing period starts when opening or closing the window or the door.

If **switches for permanent operation** are taught-in, for example wireless transmitter modules or FTS14EM, it is switched on when pressing and the time will be started when releasing.

The LED below the upper function rotary switch performs during the teach-in process according to the operating instructions. It shows control commands by short flickering during operation.

FTN14	RS485 bus actuator Staircase off-delay timer	Art. No. 30014011	58,40 €/pc.
--------------	---	--------------------------	--------------------

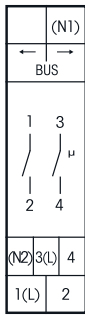

F2L14

2-speed fan relay, 1+1 NO contacts potential free 16 A/250 V AC, with DX technology. Bidirectional. Only 0.1 watt standby loss.

Modular device for DIN-EN 60715 TH35 rail mounting. 1 module = 18 mm wide, 58 mm deep.
Connection to the Eltako-RS485 bus. Bus cross wiring and power supply with jumper.
Patented Eltako Duplex technology allows you to switch normally potential free contacts in zero passage switching when 230 V A/C voltage 50 Hz is switched. This drastically reduces wear. To achieve this, simply connect the N conductor to the terminal (N1) and L to 1(L) and/or N to (N2) and L to 3(L). This results in an additional standby consumption of only 0.1 watt.

If supply voltage fails, the switching state is retained. When supply voltage is restored, the device is switched off in defined mode.

This fan relay evaluates the information of up to 23 passive sensors, e.g. wireless pushbuttons, window/door contacts, window handle sensors FFG7B-rw or wireless transmitter modules. Active sensors for CO₂, air quality, humidity and temperature are also evaluated.

Several active sensors can be linked by the PCT14 PC Tool.

When the two contacts are switched in parallel, the 2-speed actuator for 2 fan speeds becomes an actuator for one fan.

The middle rotary switch must be set to position LRN for teach-in. Set the required operating mode when the fan actuator is in operation.

During the teach-in process, adjust **the upper rotary switch** to set the sensor type. A wireless pushbutton (**exclusive**) with double rocker is taught-in in rotary switch position 1. Double rockers are assigned automatically: top left Stage 1 (only contact 1-2 closed), top right stage 2 (only contact 3-4 closed). Bottom left and bottom right OFF: both contacts open.

A wireless pushbutton (adding) with double rocker is taught-in in rotary switch position 2. Double rockers are assigned automatically: top left stage 1 (contact 1-2 closed), top right Stage 2 (contacts 1-2 and 3-4 closed). Bottom left and bottom right OFF: both contacts open.

If you switch the two contacts in parallel, one wireless pushbutton and 1 rocker are sufficient. In this case, top is ON and bottom is OFF

In rotary switch position 3, teach in ON/OFF switch with double rocker (all rockers are assigned automatically) and wireless transmitter modules When you teach in an FTK device, window handle sensor FFG7B-rw or active sensor, there is no need to take the teach-in position into account.

When operated with an active sensor, set the switch-in threshold on **the lower rotary switch**. When the threshold is reached, Stage 1 (Contact 1-2) is switched on. At **the upper rotary switch**, set the addition value at which Stage 2 (Contact 3-4). Turn **the middle rotary switch** to set one of the operating modes AUTO1 to AUTO7.

AUTO1: for manual mode of a 2-stage fan by means of a double rocker wireless pushbutton. Each contact is closed separately (exclusive) or contact 3-4 cuts in to switch stage 2 (accumulative). This is determined when teaching-in. Passive sensors, such as wireless pushbuttons and transmitter modules, which are taught-in as a off-switches, cause opening of both contacts. As long as the control voltage is applied to transmitter modules or a window monitored by an FTK or window handle sensor FFG7B-rw is open, the contacts are open and can not be switched on manually. **AUTO2:** Activating with either a wireless CO₂ or air quality sensor. The switch-on thresholds are set by the lower and upper rotary switches. The contacts close 'exclusively'. **AUTO3:** Activating with wireless CO₂ sensor. The switch-on thresholds are set by the lower and upper rotary switches. The contacts close 'exclusively'. **AUTO4:** Same as AUTO2, but activated by the wireless temperature sensor. **AUTO5:** Same as AUTO2, but the contacts close 'adding'. **AUTO6:** Same as AUTO3, but the contacts close 'adding'. **AUTO7:** Same as AUTO4, but the contacts close 'adding'.

Overview of switch-on thresholds for CO₂, air quality, humidity and temperature see operating instructions.

The LED below the upper function rotary switch performs during the teach-in process according to the operating instructions. It shows control commands by short flickering during operation.

Function rotary switches

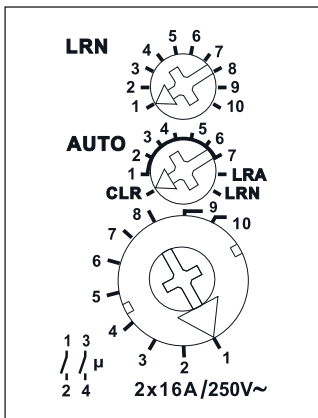

Standard setting ex works.

Further settings can be made using the PC Tool PCT14 (see page 1-5).



Manuals and documents in further languages:
<http://eltako.com/redirect/F2L14>

Housing for operating instructions GBA14 page 1-49.

F2L14	RS485 bus actuator 2-speed fan relay	Art. No. 30014067	66,40 € / pc.
-------	--------------------------------------	-------------------	---------------

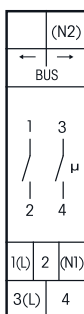

FHK14



Heating/cooling relay, 1+1 NO contacts potential free 4 A/250 V AC, with DX technology. Bidirectional. Only 0.1 watt standby loss.

Modular device for DIN-EN 60715 TH35 rail mounting.
1 module = 18 mm wide, 58 mm deep.

Connection to the Eltako-RS485 bus. Bus cross wiring and power supply with jumper. Patented Eltako Duplex technology allows you to switch normally potential free contacts in zero passage switching when 230 V A/C voltage 50 Hz is switched. This drastically reduces wear. To achieve this, simply connect the N conductor to the terminal (N1) and L to 1(L) and/or N to (N2) and L to 3(L). This results in an additional standby consumption of only 0.1 watt.

When both relays of the FHK14 are switched on, 0.4 watts are required.
If supply voltage fails, the device is switched off in defined mode.

This heating/cooling relay assesses information about wireless temperature controllers or sensors. Possibly supplemented by window/door contacts, motion detectors, window handle sensor FFG7B-rw and wireless pushbuttons.

As an alternative to a wireless temperature controller, the temperature information on the set and actual values can be obtained from a controller.

It is also possible to specify the set temperature via the controller and thus limiting the setting range of the wireless temperature controller.

Top rotary switch for adjustable hysteresis:

Left stop: lowest hysteresis 0.5°. **Middle position:** hysteresis 2.5°. **Right stop:** largest hysteresis 4.5°. Inbetween, divisions in steps of 0.5°.

Middle rotary switch for regulation types:

AUTO 1: With PWM control at T = 4 minutes. (PWM = pulse width modulation).
(suitable for valves with thermoelectric valve drive)

AUTO 2: With PWM control at T = 15 minutes.
(suitable for valves with motor-driven valve drive)

AUTO 3: With 2-point control.

Bottom rotary switch for operating modes:

H: heating mode (Contact 1-2 and Contact 3-4); **K:** cooling mode (Contact 1-2 and Contact 3-4);

HK: heating mode (Contact 3-4) and cooling mode (Contact 1-2);

In heating mode, the **frost protection function** is always enabled. As soon as the actual temperature drops below 8°C, the temperature is controlled in the selected operating mode to 8°C.

If one or several windows are open, the output remains off **provided the window/door contacts FTK or window handle sensors FFG7B-rw** are taught-in. In heating mode, however, the frost protection remains enabled.

As long as all taught-in **motion detectors FBH** detect no motion, the device is switched to setback mode. In heating mode, the reference temperature is set back by 2°; in cooling mode, it is raised by 2°. As soon as a motion detector signals movement again, the device is switched to normal mode.

When a wireless **pushbutton FT4** is taught-in, the assignment of the 4 keys is assigned with the following fixed functions: Top right: Normal mode (can also be enabled by timer). Bottom right: Night setback mode by 4°; in cooling mode, raised by 4° (can also be enabled by timer). Top left: Setback mode by 2°, in cooling mode, raised by 2°. Bottom left: Off (in heating mode, frost protection enabled; in cooling mode permanent off). If the motion detector and wireless pushbutton are taught-in at the same time, the last telegram received is always the one that is valid. A motion detector therefore switches off a setback mode selected by wireless pushbutton when a movement is detected.

The LED below the upper function rotary switch performs during the teach-in process according to the operating instructions. It shows control commands by short flickering during operation.

Function rotary switches

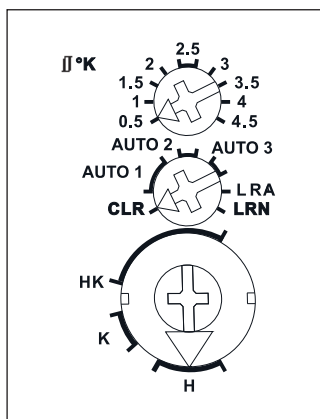

Standard setting ex works.

Further settings can be made using the PC Tool PCT14 (see page 1-5).



Manuals and documents in further languages:
<http://eltako.com/redirect/FHK14>

Connection example page 1-50.
Technical data page 1-52.
Housing for operating instructions GBA14 page 1-49.

FHK14	RS485 bus actuator heating/cooling relay	Art. No. 30014014	58,10 € / pc.
--------------	--	--------------------------	----------------------

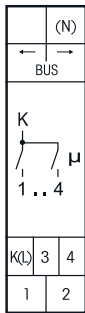

F4HK14

Heating/cooling relay with 4 channels, 1 NO contact per channel 4 A/250 V AC, potential free from the power supply, with DX technology. Bidirectional. Only 0.1 watt standby loss.

Modular device for DIN-EN 60715 TH35 rail mounting. 1 module = 18 mm wide, 58 mm deep.

Connection to the Eltako-RS485 bus. Bus cross wiring and power supply with jumper.

Patented Eltako Duplex technology allows you to switch normally potential free contacts in zero passage switching when 230 V A/C voltage 50 Hz is switched. This drastically reduces wear. To achieve this, simply connect the N conductor to the terminal (N) and L to K(L). This results in an additional standby consumption of only 0.1 watt.

When all 4 relays are switched on, a power of 0.7 watts is required.

If supply voltage fails, the device is switched off in defined mode.

This heating/cooling relay assesses information about wireless temperature controllers or sensors.

Possibly supplemented by window/door contacts, motion detectors, window handle sensor FFG7B-rw and wireless pushbuttons.

As an alternative to a wireless temperature controller, the temperature information on the set and actual values can be obtained from a controller.

It is also possible to specify the set temperature via the controller and thus limiting the setting range of the wireless temperature controller.

Top rotary switch for adjustable hysteresis:

Left stop: lowest hysteresis 0.5°. **Middle position:** hysteresis 2.5°.

Right stop: largest hysteresis 4.5°. Inbetween, divisions in steps of 0.5°.

Middle rotary switch for regulation types:

AUTO 1: With PWM control at T = 4 minutes. (PWM = pulse width modulation).

(suitable for valves with thermoelectric valve drive)

AUTO 2: With PWM control at T = 15 minutes.

(suitable for valves with motor-driven valve drive)

AUTO 3: With 2-point control.

Bottom rotary switch for operating modes:

H: heating mode (Contacts 1 to 4); **K:** cooling mode (Contacts 1 to 4);

HK: heating mode (Contact 3 and 4) and cooling mode (Contact 1 and 2);

In heating mode, the **frost protection function** is always enabled. As soon as the actual temperature drops below 8°C, the temperature is controlled in the selected operating mode to 8°C.

If one or several windows are open, the output remains off **provided the window/door contacts FTK or window handle sensors FFG7B-rw** are taught-in. In heating mode, however, the frost protection remains enabled.

As long as all taught-in **motion detectors FBH** detect no motion, the device is switched to setback mode. In heating mode, the reference temperature is set back by 2°; in cooling mode, it is raised by 2°. As soon as a motion detector signals movement again, the device is switched to normal mode.

When a **wireless pushbutton FT4** is taught-in, the assignment of the 4 keys is assigned with the following fixed functions: Top right: Normal mode (can also be enabled by timer). Bottom right: Night setback mode by 4°; in cooling mode, raised by 4° (can also be enabled by timer). Top left: Setback mode by 2°, in cooling mode, raised by 2°. Bottom left: Off (in heating mode, frost protection enabled; in cooling mode permanent off). If the motion detector and wireless pushbutton are taught-in at the same time, the last telegram received is always the one that is valid. A motion detector therefore switches off a setback mode selected by wireless pushbutton when a movement is detected.

The LED below the upper function rotary switch performs during the teach-in process according to the operating instructions. It shows control commands by short flickering during operation.

Function rotary switches

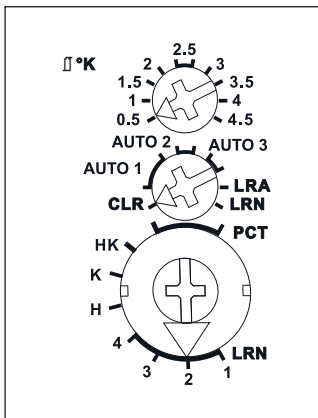

Standard setting ex works.

Further settings can be made using the PC Tool PCT14 (see page 1-5).



Manuals and documents in further languages:
<http://eltako.com/redirect/F4HK14>

Connection example page 1-50.
 Technical data page 1-52.
 Housing for operating instructions
 GBA14 page 1-49.

F4HK14	RS485 bus actuator 4-channel heating/cooling relay	Art. No. 30014010	62,90 € / pc.
---------------	--	--------------------------	----------------------



FSU14

**Display timer with 8 channels for the Eltako RS485 bus. With "astro" function.
Only 0.1 watt standby loss.**

Modular device for DIN-EN 60715 TH35 rail mounting. 1 module = 18 mm wide, 58 mm deep.

Connection to the Eltako-RS485 bus. Bus cross wiring and power supply with jumper.

For the function of the timer FSU14 it is necessary that the wireless antenna module FAM14 assigns a device address, please see the operating instructions.

The switching commands of the channels can be taught-in into bus actuators and wireless actuators.

Up to 60 timer memory locations are freely assigned to the channels. With date and automatic summer/winter time changeover. Ca. 20 days power reserve without battery.

Each memory location can either be used with astro function (automatic turn on after sunrise or sunset) or the time function. The astro switch-on and -off time can be shifted ± 2 hours and in addition, an influence of the solstices time lag of up to ± 2 hours can be entered.

The timer is set using the MODE and SET buttons and the settings can be interlocked.

Set language: Every time the power supply is applied, press SET within 10 seconds to set the language and press MODE to confirm. D = German, GB = English, F = French, IT = Italian and ES = Spanish. The normal display then appears: weekday, time, day and month.

Rapid scroll: In the following settings, the numerals scroll rapidly when you press and hold down Enter. Release then press and hold down to change the scroll direction.

Set clock: Press MODE and search for the **function CLK** with SET and select with MODE. Press MODE to set. In H, press SET to select the hour and press MODE to confirm. In M proceed in the same way to set the minute.

Set date: Press MODE and search for the **function DAT** with SET and select with MODE. Press MODE to select. At Y, press SET to select the year and press MODE to confirm. Proceed in the same way at M to set the month and at D to set the day. The last setting in the sequence is MO (weekday) blinking. Press SET to set it. From production week 08/17 the emission every minute from a **timer telegram** (hour and minute) and the day of the week can be activated.

Wireless pushbuttons for central ON/OFF, automatic off and random mode on can be taught-in.

Set position coordinates (if the astro function is required): Press MODE and search for the **function POS** with SET and select with MODE. For LAT press SET to select the latitude and press MODE to confirm. Repeat this procedure for LON to select the longitude and press MODE to confirm. Select the time zone at GMT with SET and confirm with MODE. If desired, a time lag of up to ± 2 hours for all channels can now be entered at WS (winter solstice) and SS (summer solstice).

Summer/winter time changeover: Press MODE and search for the **function SWT** with SET and select with MODE. Now press SET to switch between ON and OFF. If you select ON, changeover is automatic.

Switch random mode on/off: Press MODE and search for the **function RND** with SET and select with MODE. Press SET to set to ON (RND+) or OFF (RND) and press MODE to confirm. When random mode is switched on, all switch-on time points of all channels are shifted at random by up to 15 minutes. Switch-on times are switched earlier and switch-off times are switched later.

Lock settings: Briefly press MODE and SET together and at LCK, press SET to lock. This is displayed by an arrow next to the lock symbol.

Unlock settings: Press MODE and SET together for 2 seconds and at UNL press SET to unlock.

Wired central control: At the terminals T1/T2 and T3/T2 switches can be connected for central control.

Set operating mode: Press MODE, search the **function INT** with SET and select with MODE. Select the channel with SET at CH and confirm with MODE. You can switch between CIA (automatic with central control), AUT (automatic), ON (with priority) or OFF (with priority) with SET. If you confirm ON or OFF with MODE, the correspondent telegram will be sent immediately. If the switching state should automatically change if a time program will be active, the channel must be set to CIA or AUT again.

If MODE is pressed longer than 2 seconds, the normal display appears.

Teach-in channels in wireless actuators: Press MODE and search for the **function LRN** with SET and select with MODE. Select the channel at CH with SET and confirm with MODE. It can be switched between ON and OFF with SET. If ON is confirmed with MODE, LRN+ flashes and the function ON will be taught-in in the learning actuator with SET. Likewise it will be taught-in at OFF. See the operating instructions for more information.

Enter switching programs: press MODE and select one of the 60 memory locations from P01 to P60 with MODE and SET at the **function PRG**. See the operating instructions for more information. When **random mode** is switched on, all switching times of all channels are shifted incidentally by up to 15 minutes. Power-on times to previous and power-off times to future. For more information please see operating manual.

Further settings can be made using the PC Tool PCT14 (see page 1-5).



Manuals and documents in further languages:
<http://eltako.com/redirect/FSU14>

FSU14	RS485 bus display timer	Art. No. 30014015	64,00 € / pc.
-------	-------------------------	-------------------	---------------

RS485 BUS WEATHER DATA GATEWAY FOR MULTI SENSOR MS FWG14MS AND MULTI SENSOR MS

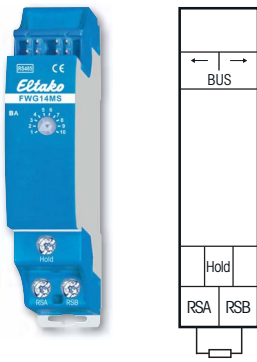

Operating mode rotary switch

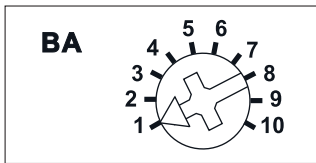

Standard setting ex works

Further settings can be made using the PC Tool PCT14 (see page 1-5).



Manuals and documents in further languages:
<http://eltako.com/redirect/FWG14MS>

Housing for operating instructions GBA14 page 1-49.



Manuals and documents in further languages:
<http://eltako.com/redirect/MS>

FWG14MS



Weather data gateway for multi sensor MS. Bidirectional. Only 0.3 watt standby loss.

Modular device for DIN-EN 60715 TH35 rail mounting.

1 module = 18 mm wide, 58 mm deep.

A multisensor MS at the gateway is connected to terminals RSA and RSB. The information is received once per second and converted into bus telegrams.

However, several FWG14MS can be connected to a multisensor MS e.g. to control several Eltako RS485 buses with only one MS multisensor. Only at one FWG14MS must the end resistor connected. At additional FWG14MS, this resistor must be removed.

Connection to the Eltako-RS485 bus. Bus cross wiring and power supply with jumper. Operation in conjunction with FAM14 or FTS14KS.

The Hold terminal is connected to the FAM14 or the FTS14KS. A maximum of two FWG14MS devices can be operated in one bus. The telegram duplicator FTD14 can also send telegrams over the Wireless Building System after the IDs of the FGW14MS are taught in the FTD14 or entered using the PTC14. Receiving devices can then be FSB14, FSB61NP and FSB71. If the multisensor MS signal is not received, an alarm telegram is sent. Using the PC Tool PCT14, 96 inputs can be AND or OR linked and up to 12 outputs can be output.

The **BA operating mode rotary switch** can be configured according to the operating instructions.

FWG14MS	RS485 Bus Weather Data Gateway for multi sensor MS	Art. No. 30014072	61,80 €/pc.
----------------	--	--------------------------	--------------------

MS



Multi sensor MS

The MS multi sensor sends the current weather details, including brightness (from three points of the compass), wind, rain and frost, to the weather data transmitter module FWS61 connected in series once per second. A standard telephone wire is sufficient as connecting lead: J-Y(ST)Y 2x2x0.8 or equivalent. 100 m line length is permitted.

Solid plastic housing, L x W x H = 118 x 96 x 77 mm. Degree of protection IP44. Temperature at mounting location -30°C to +50°C.

A power supply unit SNT61-230V/24V DC-0,25A is required for the power supply, including heating of the rain sensor. This simultaneously supplies the wireless weather data transmitter module FWS61-24V DC.

MS	Multi sensor	Art. No. 20000084	309,20 €/pc.
-----------	--------------	--------------------------	---------------------

WIRELESS WEATHER DATA TRANSMITTER MODULE FWS61-24V DC AND RS485 BUS MULTIFUNCTION SENSOR RELAY FMSR14

1-28

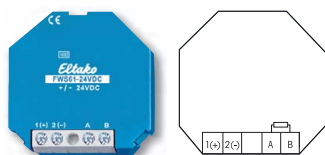

Manuals and documents in further languages:
<http://eltako.com/redirect/FWS61-24VDC>

FWS61-24V DC



Wireless weather data transmitter module for the seven weather items sent by the multisensor MS. With internal antenna. Only 0.3 watt standby loss.

For installation. 45 mm long, 45 mm wide, 18 mm deep.
 Power (24V DC) is supplied by the switch mode power supply unit WNT61-24VDC/10W (33 mm deep, 45mm long, 45mm wide). This switching power supply unit simultaneously supplies the multisensor MS including the heating of the rain sensor.

It is possible to use a deep UP box for the two devices.

This weather data transmitter module receives the seven momentary readings of the weather items: brightness (from three cardinal points), twilight, wind, rain and ambient temperature by cable J-Y (ST) Y 2x2x0,8 from the multisensor MS attached to the outside of the building. The readings are sent in the form of wireless telegrams over the Eltako wireless network with the priorities listed below. Only one MS multisensor can be connected to a wireless weather data transmitter module FWS61. However, several FWS61 can be connected to a multisensor MS. The external terminating resistor has to be present on only one FWS61. If there are other FWS61, it must be removed. The evaluation is made with a controller, the wireless multifunction sensor relay FMSR14 and/or the actuators FSB14 and FSB71.

When the supply voltage is applied, a teach-in telegram is sent immediately and two status telegrams containing the momentary values are sent approx. 60 seconds later. At least every 10 minutes, but also:

Brightness values West, South and East each from 0 to 99 kLux if a change of minimum 10% occurs.

Twilight values from 0 to 999 Lux if a change of minimum 10% occurs.

Wind speeds from 0 to 70m/s. From 4m/s to 16m/s, the momentary values are sent immediately 3 times at intervals of 1 second. After that, further value increases are sent within 20 seconds. Dropping wind speeds are sent progressively delayed by 20 seconds.

Rain values at the start are sent immediately 3 times. After the rain stops, a telegram is sent within 20 seconds.

Temperature values from -40.0°C to +80.0°C are sent every 10 minutes together with all the other values in a status telegram.

Monitoring multisensor function and line break. If the weather data message from multisensor MS is not sent for 5 seconds, the FWS61 immediately sends an alarm telegram which is repeated every 30 seconds.

The alarm telegram can be taught-in as a switch telegram in an actuator to initiate further action as required. In addition, the two status telegrams containing the values brightness 0 Lux, twilight 0 Lux, temperature -40°C (frost), wind 70 m/s and rain are sent.

When a message is again detected from the multisensor MS, the alarm stops automatically.

FWS61-24V DC	Wireless weather data transmitter module for multisensor MS	Art. No. 30000305	79,60 € / pc.
---------------------	---	--------------------------	----------------------

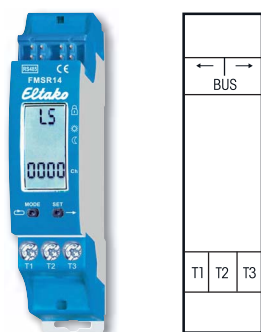

FMSR14

Multifunction sensor relay with display and 5 channels (brightness, twilight, wind, rain and frost) for the Eltako RS485 bus. Only 0.1 watt standby loss.

Modular device for DIN-EN 60715 TH35 rail mounting.

1 module = 18 mm wide, 58 mm deep.

Connection to the Eltako-RS485 bus. Bus cross wiring and power supply with jumper.

This multifunction sensor relay evaluates the wireless telegrams of the **wireless weather data transmitter module FWS61** and, dependent on the setting, issues switching commands directly to the RS485 bus and also to the wireless network in the display by means of the MODE and SET buttons. This also allows control over wireless actuators installed at decentralised positions. If only centrally installed actuators need to be addressed to control shading elements from the FWS61, it is sufficient to teach-in the FSB14s in these actuators using the PC Tool PCT14. An FMSR14 is then not required.

For the function of the sensor relay FMSR14 it is necessary that a device address is assigned from the wireless antenna module FAM14, according to the manual.

Further settings can be made using the PC Tool PCT14 (see page 1-5).



Manuals and documents in further languages:
<http://eltako.com/redirect/FMSR14>

FMSR14	RS485 bus multifunction sensor relay	Art. No. 30014028	64,00 € / pc.
---------------	--------------------------------------	--------------------------	----------------------

Housing for operating instructions GBA14
 page 1-49.

Recommended retail prices excluding VAT.

RS485 BUS SINGLE PHASE ENERGY METER WSZ14DRS-32A MIDWITH DISPLAY AND SINGLE-PHASE ENERGY METER TRANSMITTER MODULE FWZ14-65A



Typical connection

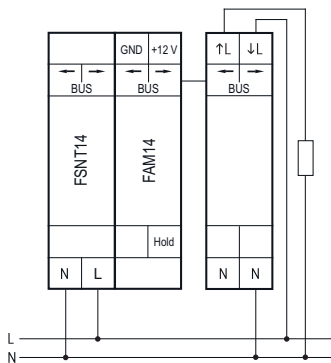

Further settings can be made using the PC Tool PCT14 (see page 1-5).



Manuals and documents in further languages:
<http://eltako.com/redirect/WSZ14DRS-32A>

Technical data page 10-27.



Further settings can be made using the PC Tool PCT14 (see page 1-5).



Manuals and documents in further languages:
<http://eltako.com/redirect/FWZ14-65A>

Housing for operating instructions GBA14 page 1-49.

WSZ14DRS-32A MID



Maximum current 32 A. Standby loss 0.4 watt only.

Modular device for DIN-EN 60715 TH35 rail mounting. 1 module = 18 mm wide and 58 mm deep.

Connection to the Eltako RS485 bus. Bus wiring and power supply with jumpers. The meter reading, the instantaneous power and the serial number are transferred to the bus - e.g. B. for transfer to an external computer, to a controller - and also sent to the radio network via the FAM14. For this it is necessary that a device address is assigned by the radio antenna module FAM14 according to the instructions manual. This single-phase energy meter measures active energy by means of the current between input and output. The internal power consumption of 0.4 watt active power is neither metered nor indicated. 1 phase conductor with a max. current up to 32 A can be connected. The start current is 20 mA. Accuracy class B (1%).

If the anticipated load exceeds 50%, maintain an air gap of 1/2 pitch unit to the devices mounted adjacently. For this purpose, the scope of delivery includes 2 spacers DS14 and, in addition to the short jumper, two more long jumpers. Two N terminals for secure cross wiring of several counters. The consumption value is stored in non-volatile memory and is displayed again immediately after a power failure. **The 7 segment LC display is also legible twice within a period of 2 weeks without power supply. Press the button.** Below the display there is a button with which you can scroll through the menu in accordance with the operating instructions. First, the **backlight** turns on. Then the total active energy, the active energy of the resettable memory and the instantaneous values of active power, voltage, current and the Pch value can be displayed. The power consumption is shown on the display with a bar that flashes 1000 times per kWh and with a red LED that flashes 2000 times per kWh.

Error message

In case of a connection error, the background lighting of the display flashes.

Meter special operating modes

In the meter operating modes, the focus is on the adjustable transmission speed of electricity meter data for external building energy managers. Data can be accessed and forwarded via gateways connected to the FAM14 (FGW14, FGW14-USB, FGW14W(L)-IP). **Additional setting options are available on the FAM14 for meters from production week 33/23..**

WSZ14DRS-32A MID	Single phase energy meter, MID	Art. No. 28032715	75,00 €/pc.
-------------------------	--------------------------------	--------------------------	--------------------

FWZ14-65A



Wireless single-phase energy meter transmitter module, maximum current 65 A. Only 0.5 watt standby loss.

Modular device for DIN-EN 60715 TH35 rail mounting. 1 module = 18 mm wide, 58 mm deep. Accuracy class B (1%). With RS485 interface.

Connection to the Eltako-RS485 bus. Bus cross wiring and power supply with jumper.

The meter reading, the current power and the serial number will be handed over to the bus - eg for forwarding to an external computer, an controller - and also to the wireless network via FAM14. For this it is necessary that a device address is assigned from the wireless antenna module FAM14, according to the manual. It measures active energy by means of the current between input and output. The internal power consumption of 0.5 watt active power is not metered. Like all meters without declaration of conformity (e.g. MID), this meter is not permitted for billing. 1 phase conductor with a max. current up to 65 A can be connected. The inrush current is 40 mA. In operation the rotary switch must be set to AUTO. Power consumption is indicated using a LED. If the L input and the L output were interchanged when hooked up, a normal rate (HT)/off-peak (NT) switchover telegram is transmitted to indicate the hook-up error. **If the anticipated load exceeds 50%, maintain an air gap of 1/2 pitch unit to the devices mounted adjacently.** Thereto included are 2 spacers DS14, a short jumper and two long jumpers.

FWZ14-65A	RS485 bus wireless single-phase energy meter transmitter module 65 A	Art. No. 30014050	82,10 €/pc.
------------------	--	--------------------------	--------------------



Typical connection

4-wire-connection 3x230/400 V

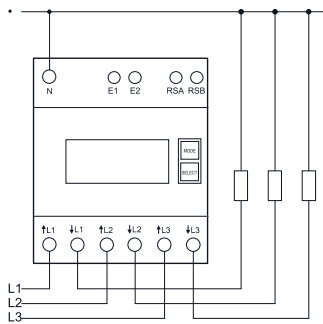

Further settings can be made using the PC Tool PCT14 (see page 1-5).



Manuals and documents in further languages:
http://eltako.com/redirect/DSZ14DRS-3*80A_MID

Housing for operating instructions GBA14 page 1-49.
 Technical data page 10-27.

DSZ14DRS-3X80A MID



RS485 bus three-phase energy meter. Maximum current 3 x 80 A. Standby loss 0.8 W at L1 and only 0.5 W at L2 and L3 each.

Modular device for DIN-EN 60715 TH35 rail mounting in distribution cabinets with IP51 protection class. 4 modules = 70 mm wide and 58 mm deep. Accuracy class B (1%). With RS485 interface.

It measures active energy by means of the current between input and output. The internal power consumption of 0.8 W or 0.5 W active power per path is neither metered nor indicated.

1, 2 or 3 phase conductors with max. currents up to 80 A can be connected.

The inrush current is 40 mA.

The terminals 1L1 and N must always be connected.

Connection to the Eltako RS485 bus via a FBA14 by means of a 2-wire screened bus line (e.g. telephone line). The meter reading and the momentary capacity are transferred to the bus – e.g. for transfer to an external computer or a controller – and is also transferred to the wireless network via the FAM14. For this it is necessary that a device address is assigned from the wireless antenna module FAM14, according to the operating instructions.

The 7 segment LC display is also legible twice within a period of 2 weeks without power supply.

The power consumption is displayed with a LED flashing 1000 times per kWh next to the display.

Designed as standard for using as double-tariff meter: Switch over to a second tariff by applying 230 V to terminals E1/E2.

On the right next to the display are the keys MODE and SELECT. Press them to scroll through the menu according to the operation manual. First the **background lighting** switches on. The display then shows the total active energy per tariff, the active energy per resettable memory RS1 or RS2, and the instantaneous values of power, voltage, current as well as the Pch value can be displayed.

Error message (false)

When the phase conductor is missing or the current direction is wrong 'false' and the corresponding phase conductor are indicated on the display.

Meter special operating modes:

In the meter operating modes, the focus is on the adjustable transmission speed of electricity meter data for external building energy managers. Data can be accessed and forwarded via gateways connected to the FAM14 (FGW14, FGW14-USB, FGW14W(L)-IP). **Additional setting options are available on the FAM14 for meters from production week 33/23.**

DSZ14DRS-3x80A	RS485 bus three-phase energy meter with display, MID	Art. No. 28365715	200,50 €/pc.
-----------------------	--	--------------------------	---------------------



Typical connection

4-wire-connection 3x230/400 V

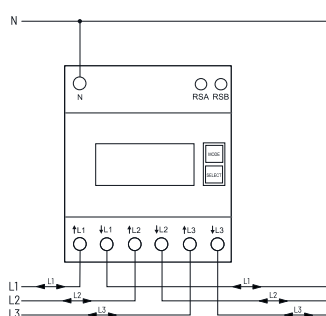

Further settings can be made using the PC Tool PCT14 (see page 1-5).



Manuals and documents in further languages:
http://eltako.com/redirect/DSZ14DRSZ-3*80A_MID

Housing for operating instructions GBA14 page 1-49.
 Technical data page 10-27.

DSZ14DRSZ-3x80A MID



1-31

RS485 bus bidirectional three-phase meter. Maximum current 3x80 A. Standby loss 0,8 W at L1 and only 0,5 W at L2 and L3 each.

Modular device for DIN-EN 60715 TH35 rail mounting in distribution cabinets with IP51 protection class. 4 modules = 70 mm wide and 58 mm deep. Accuracy class B (1%). With RS485 interface.

It measures active energy by means of the current between input and output. The internal power consumption of 0,8 W or 0,5 W active power per path is neither metered nor indicated.

The active energy is added depending on the sign. Positive power in the meter means energy consumption, negative power means energy delivery. The energy measurement is balanced.

If the energy consumption (P positive) is greater than the energy supply (P negative), the meter reading T → is increased. If the energy supply is greater than the energy consumption, the meter reading T ← is increased. Energy consumption is shown with a right arrow → and energy supply is shown with a left arrow ← above the active bar in the display.

1, 2 or 3 phase conductors with max. currents up to 80 A can be connected.

The inrush current is 40 mA.

The terminals L1 and N must always be connected.

Connection via a FBA14 to the Eltako RS485 bus with a 2-wire shielded bus cable (telephone cable).

The meter reading and the momentary power are transferred to the bus – e.g. for transfer to an external computer or a controller – and is also transferred to the wireless network via the FAM14. For this it is necessary that a device address is assigned from the wireless antenna module FAM14, according to the operating instructions.

Energy consumption and energy supply values are stored in non-volatile memory and are displayed again immediately after a power failure.

The 7 segment LC display is also legible twice within a period of 2 weeks without power supply.

Power consumption is indicated using a LED next to the display flashing 1000 times per kWh.

On the right next to the display are the keys MODE and SELECT. Press them to scroll through the menu.

First the **background lighting** switches on. Then the total active energy per consumption and delivery, the active energy of the resettable memory consumption and delivery and the instantaneous values of power, voltage, current as well as the Pch value can be displayed.

Error message

If a phase connection is missing, the corresponding phase is shown on the display.

Meter special operating modes:

In the meter operating modes, the focus is on the adjustable transmission speed of electricity meter data for external building energy managers. Data can be accessed and forwarded via gateways connected to the FAM14 (FGW14, FGW14-USB, FGW14W(L)-IP). **Additional setting options are available on the FAM14 for meters from production week 33/23..**

DSZ14DRSZ-3x80A	RS485 bus bidirectional three-phase meter with display, MID	Art. No. 28465715	232,20 €/pc.
------------------------	---	--------------------------	---------------------

RS485 BUS THREE-PHASE ENERGY METER WITH SETTABLE CT RATIO, DSZ14WDRS-3X5A MID

1-32



Typical connection

4-wire-connection 3x230/400 V

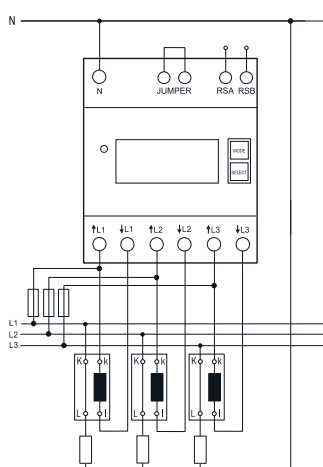

Further settings can be made using the PC Tool PCT14 (see page 1-5).



Manuals and documents in further languages:
http://eltako.com/redirect/DSZ14WDRS-3*5A_MID

Housing for operating instructions GBA14 page 1-49.

DSZ14WDRS-3X5A MID



RS485 bus three-phase energy meter with settable CT ratio and MID. Maximum current 3x5 A. Standby loss 0.8 W at L1 and only 0.5 W at L2 and L3 each.

Modular device for DIN-EN 60715 TH35 rail mounting in distribution cabinets with IP51 protection class. 4 modules = 70 mm wide and 58 mm deep.

Accuracy class B (1%). With RS485 interface.

This three-phase energy meter measures active energy by means of the current between input and output. The internal power consumption of 0.8 W or 0.5 W active power per path is neither metered nor indicated.

1, 2 or 3 phase conductors with max. currents up to 5 A can be connected.

The inrush current is 10 mA.

The terminals #L1 and N must always be connected.

Connection to the Eltako RS485 bus via a FBA14 by means of a 2-wire screened bus line (e.g. telephone line). The meter reading and the momentary capacity are transferred to the bus – e.g. for transfer to an external computer or a controller – and is also transferred to the wireless network via the FAM14. For this it is necessary that a device address is assigned from the wireless antenna module FAM14, according to the operating instructions.

The 7 segment LC display is also legible twice within a period of 2 weeks without power supply.

The power consumption is displayed with a LED flashing 10 times per kWh next to the display.

On the right next to the display are the keys MODE and SELECT. Press them to scroll through the menu.

First the **background lighting** switches on. The display then shows the total active energy, the active energy of the resettable memory and the instantaneous values of power, voltage, current as well as the Pch value can be displayed..

The CT ratio can also be set. It is set to 5:5 at the factory and blocked with a bridge over the terminals which are marked with 'JUMPER'. To adjust the CT ratio to the installed transformer remove the bridge and reset the energy meter according to the operation manual. Then block it again with the bridge. Adjustable current transformer ratios: 5:5, 50:5, 100:5, 150:5, 200:5, 250:5, 300:5, 400:5, 500:5, 600:5, 750:5, 1000:5, 1250:5 and 1500:5.

Error message (false)

When the phase conductor is missing or the current direction is wrong 'false' and the corresponding phase conductor are indicated on the display.

Important! Before working on the current transformers disconnect the voltage paths of the energy meters.

Meter special operating modes:

In the meter operating modes, the focus is on the adjustable transmission speed of electricity meter data for external building energy managers. Data can be accessed and forwarded via gateways connected to the FAM14 (FGW14, FGW14-USB, FGW14W(L)-IP). **Additional setting options are available on the FAM14 for meters from production week 33/23.**

DSZ14WDRS-3x5A	RS485 bus three-phase energy meter with settable CT ratio with display, MID	Art. No. 28305712	209,10 €/pc.
-----------------------	---	--------------------------	---------------------

RS485 BUS ENERGY METER DATA GATEWAY FSDG14 AND IR SCANNER FOR ENERGY METERS AIR



FSDG14

Wireless energy meter data gateway for meters equipped with an IEC 62056-21 IR interface. 2 channels. Only 0.4 watt standby loss.

Modular device for DIN-EN 60715 TH35 rail mounting.
1 module = 18 mm wide, 58 mm deep.

Connection to the Eltako-RS485 bus. Bus cross wiring and power supply with jumper.

This energy meter data gateway can provide the data of an electronic domestic supply meter (eHZ-EDL) with IR interface according to IEC 62056-21 and SML protocol version 1 to the RS485 bus. Either for forwarding to an external computer or a controller.

Regular flashing of the **green LED** indicates that the FSDG14 is receiving data from the meter. Active power, up to 4 meter readings and the serial number are transferred. The serial number corresponds to the last 4 bytes (hex) of the server ID printed on the meter. The telegram is sent over the wireless building service by means of the wireless antenna module FAM14. Usage data are transmitted over channel 1 and delivery data over channel 2. It is therefore essential for the FAM14 to issue a device address. If there is a change in active power or a meter reading, the appropriate telegram is sent immediately and all telegrams including the serial number are sent cyclically every 10 minutes.

The PCT14 PC tool can also read out the FSDG14.

Turn the rotary switch to select the following operating modes (OBIS codes according to IEC 62056-61):

- 1: Usage meter (1.8.0) and usage power on channel 1, delivery meter (2.8.0) and delivery power on Channel 2.
- 2: Usage tariff 1 (1.8.1) and tariff 2 (1.8.2) and usage power on channel 1, delivery tariff 1 (2.8.1) and tariff 2 (2.8.2) and delivery power on channel 2.
- 3: Usage tariff 1 (1.8.1) and tariff 2 (1.8.2) and usage power on channel 1, delivery meter (2.8.0) and delivery power on Channel 2.
- 4: Usage meter (1.8.0) and usage power on channel 1, delivery tariff 1 (2.8.1) and tariff 2 (2.8.2) and delivery power on channel 2.

The link is made by using an AIR IR scanner. The scanner is attached by its fixing magnets to the IR output of the meter and is connected by its connecting cable to terminals Rx, GND and +12 V.

Function rotary switch

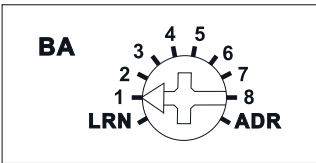

Standard setting ex works.



FSDG14	RS485 bus energy meter data gateway	Art. No. 30014066	59,60 €/pc.
AIR	IR scanner for energy meters	Art. No. 30000970	111,10 €/pc.

IR scanner for energy meters AIR

Manuals and documents in further languages:
<http://eltako.com/redirect/FSDG14>

Manuals and documents in further languages:
<http://eltako.com/redirect/AIR>

Housing for operating instructions GBA14 page 1-49.



Further settings can be made using the PC Tool PCT14 (see page 1-5).



Manuals and documents in further languages:
<http://eltako.com/redirect/F3Z14D>

Housing for operating instructions GBA14 page 1-49.

F3Z14D



**Wireless meter concentrator for electricity, gas and water meters.
 For 3 S0 interfaces and/or 3 AFZ scanners, only 0.1 watt standby loss.**

Modular device for DIN-EN 60715 TH35 rail mounting.
 1 module = 18 mm wide, 58 mm deep.

Connection to the Eltako-RS485 bus. Bus cross wiring and power supply with jumper.

This meter concentrator concentrates the data of up to three electricity, data and water meters and supplies this data to the RS485 bus. Either for forwarding to an external computer or for sending over the Wireless Building System.

Hook-up is either by connection to the S0 interface of the meters or by use of an AFZ scanner on each Ferraris meter. The scanner is bonded above the rotary disc of the meter and connected by its connecting wire to one of the S01-S03/GND terminals. The F3Z14D detects automatically whether an S0 interface or an AFZ is connected.

The meter reading is entered into the display by two pushbuttons as well as the impulse rate (number of impulses or revolutions per kilowatt hour or cubic meter). The settings can be locked.

Meter readings can be entered and read out using the **PCT14 PC Tool**. In addition, impulse rates can be entered. The default display is selectable and operation of the device is interlocked.

The display is subdivided into 3 fields.

Field 1:

The default display is the unit of the meter reading currently displayed in field 3, either in kilowatt hours kWh or megawatt hours MWh or cubic meter M3 or cubic decametre DM3

Field 2:

Momentary value of active power in watts and kilowatts or flow in centilitres and decilitres.

The arrow on the left in display field 1 indicates automatic switchover from 0-99 W or cl/s to 0.1 to 65 kW or dal/s. The display depends on the number of impulses of the meter.

The displayed minimum load is e.g. 10 watts at 2000 impulses per KWH and 2000 watts at 10 impulses per KWH.

Field 3:

The meter reading is the default display. Every 4 seconds, the display alternates between 3 integer numbers and 1 decimal point (from 0 to 999.9) and an additional 1 or to 3 integer numbers (from 0 to 999).

Select meter in display:

Press MODE and then press MODE again to select the **ANZ function**. Press SET to select the meter number to be displayed as default. Press MODE to confirm.

Issue device address in the bus and send teach-in telegrams as described in the operating instructions.

All Eltako energy meters are fitted with an S0 interface and can therefore be connected to the energy meter concentrator F3Z14D. Only devices FWZ14-65A, DSZ14DRS-3x80A and DSZ14WDRS-3x5A are directly connected to the bus.

F3Z14D	RS485 bus meter collector	Art. No. 30014055	60,90 €/pc.
---------------	---------------------------	--------------------------	--------------------



Function rotary switch

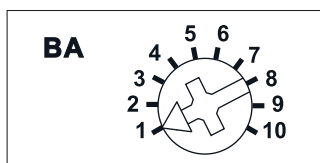

Standard setting ex works.

Further settings can be made using the PC Tool PCT14 (see page 1-5).



Manuals and documents in further languages:
<http://eltako.com/redirect/FGW14>

FEM and FEM65-wg page 1-45.
 Housing for operating instructions GBA14 page 1-49.

FGW14

Multiple Gateway. Bidirectional. Only 0.5 watt standby loss.

Modular device for DIN-EN 60715 TH35 rail mounting.
 1 module = 18mm wide, 58mm deep.
 The gateway is only 1 module wide but has multiple uses: For coupling of up to three FEM, for direct connection via the RS232 interface with the PC, for connection to the bus components of the older Series 12 or as a bus connector of two RS485 buses of Series 14.

Connection to the Eltako-RS485 bus. Bus cross wiring and power supply with jumper.
Operation in conjunction with FAM14 or FTS14KS.

The Hold terminal is connected to the FAM14 or the FTS14KS.
 Wireless receiver modules FEM are connected in parallel to the sub-bus terminals RSA2 and RSB2 as well as the power supply terminals GND and +12V.
 Up to 10 pushbutton input modules FTS12EM can be connected in series to the sub-bus terminals RSA2 and RSB2. If necessary in series with wireless receiver modules FEM (see page 1-45).
 The PC connection is via connection to the terminals Tx and Rx.
 Series 12 actuators are connected to the sub-bus terminals RSA2 and RSB2. There is no Hold connection in this case.
 A second Series 14 bus is fed into the terminals RSA2/RSB2.
 The settings of the **operating mode rotary switch BA** are carried out as described in the operating instructions.

FGW14	RS485 bus multiple gateway	Art. No. 30014017	68,50 €/pc.
--------------	----------------------------	--------------------------	--------------------

**RS485 BUS ENERGY METERS MQTT GATEWAY VIA WLAN FGW14W-IP AND
RS485 BUS ENERGY METERS MQTT GATEWAY VIA WLAN OR LAN FGW14WL-IP**

1-36



Function rotary switch

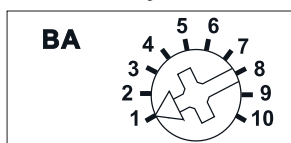

Standard setting ex works.



Manuals and documents in further languages:
<http://eltako.com/redirect/FGW14W-IP>

Housing for operating instructions
GBA14 page 1-49.



Function rotary switch

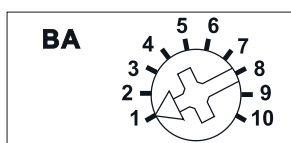

Standard setting ex works.



Manuals and documents in further languages:
<http://eltako.com/redirect/FGW14WL-IP>

Housing for operating instructions
GBA14 page 1-49.

FGW14W-IP



**Gateway with IP interface for Series 14 energy meters via WLAN.
Only 0.8 watt standby loss.**

Modular device for DIN-EN 60715 TH35 rail mounting.

1 module = 18 mm wide, 58 mm deep.

The gateway is only 1 module wide: For operation, the gateway must be integrated into a WLAN.

The WLAN connection uses the 2.4 GHz frequency band.

Connection to the Eltako-RS485 bus. Bus cross wiring and power supply with jumper.

Operation in conjunction with FAM14 or FTS14KS.

The IP connection is via WLAN. The gateway transmits data from any Eltako electricity meter on the RS485 bus using the MQTT protocol. The data is transferred from the RS485 bus to any external MQTT broker. For more details on MQTT see e.g. <https://mqtt.org/>

The data is encoded according to the EnOcean/IP format, see: www.enocean-alliance.org/specifications/

Configurations and updates are made via the Eltako Connect app or via a web interface.

A REST API is available on the device's online product page.

FGW14W-IP	RS485 Bus energy meters MQTT Gateway via WLAN; MQTT and REST-API	Art. No. 30014041	92,40 € / pc.
------------------	--	--------------------------	----------------------

FGW14WL-IP



**Gateway with IP interface for Series 14 energy meters via WLAN or LAN.
Only 0.8 watt standby loss.**

Modular device for DIN-EN 60715 TH35 rail mounting.

1 module = 18 mm wide, 58 mm deep.

The gateway is only 1 module wide: For operation, the gateway must be integrated into a WLAN or LAN.

The WLAN connection uses the 2.4 GHz frequency band. The LAN connection is via RJ45 connector with 10/100Base-T.

Connection to the Eltako-RS485 bus. Bus cross wiring and power supply with jumper.

Operation in conjunction with FAM14 or FTS14KS.

The Hold terminal is connected to the FAM14 or the FTS14KS.

The IP connection is via LAN or WLAN. The gateway transmits data from any Eltako electricity meter on the RS485 bus using the MQTT protocol. The data is transferred from the RS485 bus to any external MQTT broker. For more details on MQTT see e.g. B. <https://mqtt.org/>

The data is encoded according to the EnOcean/IP format, see: www.enocean-alliance.org/specifications/

Configurations and updates are made via the Eltako Connect app or via a web interface.

A REST API is available on the device's online product page.

FGW14WL-IP	RS485 Bus energy meters MQTT Gateway via WLAN or LAN; MQTT and REST-API	Art. No. 30014051	106,50 € / pc.
-------------------	---	--------------------------	-----------------------

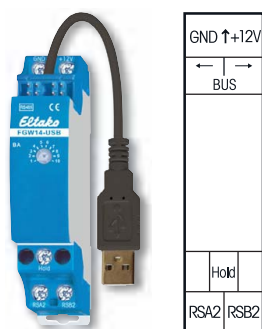

Operating mode rotary switch

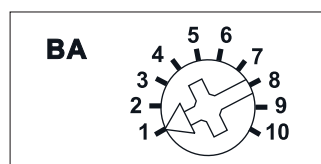

Standard setting ex works.

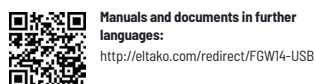

Housing for operating instructions GBA14 page 1-49.

FGW14-USB



1-37

Multiple gateway with USB-A connection. Bidirectional. Only 0.3 watt standby loss.

Modular device for DIN-EN 60715 TH35 rail mounting.

1 module = 18 mm wide, 58 mm deep.

The gateway is only 1 module wide but has multiple uses: **To connect a controller or PC via a USB interface, to couple up to three FEM devices, for connection to the bus components of the older Series 12 or as a bus connector of two RS485 buses of Series 14.**

Connection to the Eltako-RS485 bus. Bus cross wiring and power supply with jumper. Operation in conjunction with FAM14 or FTS14KS.

The Hold terminal is connected to the FAM14 or the FTS14KS.

The PC is connected via a USB interface running at 9600 baud or 58 kbaud.

Wireless receiver modules FEM are connected in parallel to the sub-bus terminals RSA2 and RSB2 as well as the power supply terminals GND and +12 V.

Up to 10 pushbutton input modules FTS12EM can be connected in series to the sub-bus terminals RSA2 and RSB2. If necessary in series with wireless receiver modules FEM.

The controller or PC connection is via connection to the terminals Tx and Rx.

Series 12 actuators are connected to the sub-bus terminals RSA2 and RSB2. There is no Hold connection in this case.

A second Series 14 bus is fed into the terminals RSA2/RSB2.

The settings of the **operating mode rotary switch BA** are carried out as described in the operating instructions.

FGW14-USB	RS485 bus multiple gateway with USB-A connection	Art. No. 30014049	64,90 €/pc.
USB cable	USB extension cord, 2 m long, Type A, ST/BU	Art. No. 30000020	15,90 €/pc.

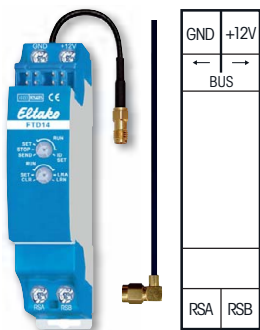

Function rotary switches

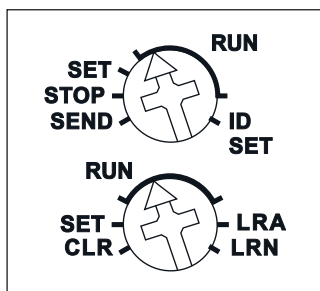

Further settings can be made using the PC Tool PCT14 (see page 1-5).

Manuels and documents in further languages:
<http://eltako.com/redirect/FTD14>

Housing for operating instructions GBA14 page 1-49.

FTD14



Telegram duplicator for the Eltako RS485 bus with exchangeable antenna. Only 0.5 watt standby loss.

Modular device for DIN-EN 60715 TH35 rail mounting.
 1 module = 18 mm wide, 58 mm deep.

Connection to the Eltako-RS485 bus. Bus cross wiring and power supply with jumper. Operation in conjunction with FAM14 or FTS14KS.

The telegrams of taught-in IDs are duplicated and directly sent into the Eltako wireless network with a new output ID. These wireless telegrams can be specifically taught-in in decentralized actuators.

A total of 120 memory locations are available.

The upper rotary switch is used to selectively transmitting a wireless telegram. In normal operation, it is set to RUN.

The bottom rotary switch is used for teaching-in and deleting IDs. In normal operation, it is set to RUN.

The red LED below the upper rotary switch performs during the teaching-in process.

The green LED below the lower rotary switch lights up briefly when a wireless telegram is transmitted.

The enclosed small antenna can be replaced with a wireless antenna FAG55E- or FA250 with magnetic base and cable.

FTD14	RS485 bus telegram duplicator	Art. No. 30014057	92,60 €/pc.
-------	-------------------------------	-------------------	-------------



Manuals and documents in further languages:
<http://eltako.com/redirect/FBA14>

Housing for operating instructions GBA14 page 1-49.

FBA14



Bus coupler for wire connections of bus and power supply jumpers Series 14.

Modular device for DIN-EN 60715 TH35 rail mounting.
 1 module = 18 mm wide, 58 mm deep.

Bus cross wiring and power supply with jumper.

Bus coupler FBA14 can connect various bus parts as well as feed power supplies.

Bus parts on different DIN rails or in other distributors or switch cabinets are each connected to an FBA14 and a 4-wire screened bus line, e.g. a telephone line. The total length of all connecting lines should not exceed 100 m. A 9 mm wide second terminating resistor (supplied with the FAM14 respectively FTS14KS) must be plugged into the last actuator.

The bus coupler may be positioned at any point in a Series 14 device row. The 4 wires of the bus line are connected to the -12 V, +12 V, RSA and RSB terminals of the two FBA14s.

The jumper plugged in ex works to the lower terminal block must remain fitted to ← +12 V →.

This jumper also remains fitted if a wide-range power supply unit WNT15-12VDC/24W is connected to the +12 V and -12 V terminals to produce power supply redundancy.

If the power supply of the switch mode power supply unit in the FAM14 or FTS14KS is insufficient to power the entire RS485 bus, a wide-range power supply unit WNT15-12VDC/24W can be connected to the -12 V and +12 V terminals of the bus coupler to increase capacity. In this case the jumper must be removed.

Actuators to the left of the bus coupler are powered by the FAM14 or FTS14KS, actuators to the right are powered by the switch mode power supply unit.

FBA14	RS485 bus coupler	Art. No. 30014018	33,40 €/pc.
--------------	-------------------	--------------------------	--------------------

WIRELESS ACTUATORS IN HEATING CIRCUIT DISTRIBUTORS WITH WIRELESS ROOM TEMPERATURE CONTROLLERS

Wireless room temperature controllers transmit wireless telegrams containing setpoints and actual values to a wireless antenna module in the heating circuit distributor. The distributor passes on the received data via an internal RS485 bus to actuators to control the device motors.

The modular design means that only the hardware actually needed is installed. This saves the cost of unnecessary actuators.

The usual term 'single room control' does not mean that only one room is controlled. In fact, zones are controlled. Every zone (e.g. every room) may have a separate room temperature controller and several zones in a room may have a common controller.

Up to 25 actuators can be supplied with the FSNT14 power supply, which is included with the FAM14 antenna module. Each actuator can control 1 or 2 heat zones. 2 actuators per zone can be directly connected.

If several actuators are required per zone, additional actuators are simply assigned to one zone.

The smallest unit consists of a switching power supply unit FSNT14 (1TE), an antenna module FAM14 (1TE) and a 1TE wide 2-zone actuator FAE14. One PU is only 18 mm wide.

The total width of the smallest unit with 2 zones is therefore only 3 PU = 54 mm. With 6 zones, the module width adds up to only 90 mm and with 12 zones, the total width is only 144 mm.

The actuators are powered by electronic solid state relays for 230 V actuators which have a practically unlimited service life, type FAE14SSR. In addition with conventional PCB relays for 24 V actuators, type FAE14LPR.

Modules are quickly cross-connected to the upper information side (bus and internal power supply) by means of jumpers.



FAM14 | FAE14SSR

Further informations FAM14 page 1-3 and FAE14SSR page 1-41.

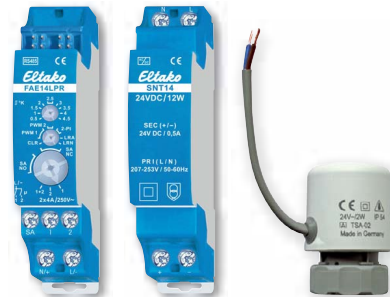

FAE14LPR | SNT14 | TSA02NC

Further informations FAE14LPR page 1-42, SNT14 page 17-4 and TSA02NC page 1-43.

24 V DC actuators are powered by 12 W, 24 W or 48 W by a switch mode power supply unit SNT14-24V DC snapped on the right hand side. This can be connected to a pre-assembled SAS busbar for 6 or more actuators. Otherwise it is connected with wire bridges.



FAE14SSR

Noiseless 2-channel single room control, 400 W. 2 solid state relays not potential free. Bidirectional. Only 0.1 watt standby loss.

Modular device for DIN-EN 60715 TH35 rail mounting. 1 module = 18 mm wide, 58 mm deep.

Connection to the Eltako-RS485 bus. Bus cross wiring and power supply with jumper.

If both relays are switched on, a power of 0.4 watts is required.

The rated switching capacity of 400 W is applied for one contact and also for the sum of the two contacts.

From production week 35/16 with automatic electronic over temperature shutdown.

With a load < 1W a GLE must be switched parallel to the load.

First teach in the sensors **using the rotary switches.**

The channels can be taught-in together at the same time. Use the lower rotary switch in positions 1+2.

Alternatively, they can be taught-in separately in position 1 or 2.

Then set the operating mode using the middle rotary switch:

PWM 1 for valves with thermoelectric actuator, T = 4 minutes.

PWM 2 for valves with motor-driven actuator, T = 15 minutes.

2-Pt for 2-point control.

PWM control mode: The upper rotary switch sets the required temperature difference at which the device is switched on at 100%.

When the actual temperature \geq reference temperature, the device is switched off.

When the actual temperature \leq (reference temperature - hysteresis), the device is switched on at 100%.

When the actual temperature is between (reference temperature - hysteresis) and the reference temperature, the device is switched on and off by a PWM in steps of 10% depending on the temperature difference. The lower the temperature difference, the shorter the switch-on time. As a result of the settability of the 100% value, the PWM can be adapted to the radiator size and inertia. The signs are the opposite in cooling mode.

In heating mode, the **frost protection function** is always enabled. As soon as the actual temperature drops below 8°C, the temperature is controlled in the selected operating mode to 8°C.

Two-point control mode: The upper rotary switch sets the required difference between the switch-on and switch-off temperatures.

When the actual temperature \geq reference temperature, the device is switched off.

When the actual temperature \leq (reference temperature - hysteresis), the device is switched on.

The signs are the opposite in cooling mode.

The type of connected actuators will be selected with **the lower rotary switch. SA NC** for actuator NC (normally closed) or **SA NO** for actuator NO (normally open).

When **wireless window/door contacts FTK** or **window handle sensors FFG7B** are taught-in, they are OR linked. If one or more windows are open, the output remains off. In heating mode, however, the frost protection remains enabled.

When **motion detectors FBH** are taught-in, they are AND linked. If all FBHs signal 'No motion', the device switches to standby setback mode: In heating mode, the reference temperature is set back by 2°; in cooling mode, it is raised by 2°. As soon as a motion detector signals movement again, the device is switched to normal mode.

When the **FBHs and wireless pushbuttons** are taught-in, the last telegram received is always the one that is valid. An FBH therefore switches off a setback mode selected by means of the wireless pushbutton when motion is detected.

When a **wireless pushbutton** is taught-in, the 4 keys are assigned the following functions:

Top right: Normal mode (can also be enabled by timer with the function 'ON'). Bottom right: Night setback mode by 4°; in cooling mode: increase by 4° (can also be enabled by timer with the function 'OFF'). Top left: Standby setback mode by 2°, in cooling mode, increase by 2°. Bottom left: Off (in heating mode, frost protection enabled; in cooling mode permanent off).

Malfunction mode: If no wireless telegram will be received from a temperature sensor for more than 1 hour, the LED lights up and it will be switched to **fault mode:** in heating mode it will be switched on for 1.2 minutes and switched off for 2.8 minutes at PWM 1. At PWM 2 and 2-Pt the times are 4,5 minutes 'on' and 10.5 minutes 'off'.

The device is switched off in cooling mode. When a wireless telegram is again received, the LED goes out and the device switches back to normal mode.

The LED below the upper function rotary switch performs during the teach-in process according to the operating instructions. It shows control commands by short flickering during operation.

Function rotary switches

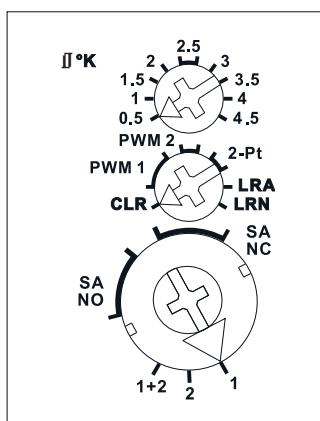

Further settings can be made using the PC Tool PCT14 (see page 1-5).



Manuals and documents in further languages:
<http://eltako.com/redirect/FAE14SSR>

FAE14SSR	RS485 bus actuator single room control, heating/cooling for 2 zones with solid state relay	Art. No. 30014029	67,90 € /pc.
-----------------	--	--------------------------	---------------------



FAE14LPR

2-channel single room control, 4 A/250 V, potential free. Bidirectional. Only 0.1 watt standby loss.

Modular device for DIN-EN 60715 TH35 rail mounting. 1 module = 18 mm wide, 58 mm deep.
Connection to the Eltako-RS485 bus. Bus cross wiring and power supply with jumper.

If both relays are switched on, a power of 0.4 watts is required.

The channels can be taught-in together at the same time. Use the lower rotary switch in positions 1+2. Alternatively, they can be taught-in separately in position 1 or 2.

First teach in the sensors **using the rotary switches**. In normal mode, set the operating mode using the middle rotary switch.

PWM 1 for valves with thermoelectric actuator, T = 4 minutes.

PWM 2 for valves with motor-driven actuator, T = 15 minutes.

2-Pt for 2-point control.

PWM control mode: The upper rotary switch sets the required temperature difference at which the device is switched on at 100%.

When the actual temperature \geq reference temperature, the device is switched off.

When the actual temperature \leq (reference temperature - hysteresis), the device is switched on at 100%.

When the actual temperature is between (reference temperature - hysteresis) and the reference temperature, the device is switched on and off by a PWM in steps of 10% depending on the temperature difference.

The lower the temperature difference, the shorter the switch-on time. As a result of the settability of the 100% value, the PWM can be adapted to the radiator size and inertia.

The signs are the opposite in cooling mode.

In heating mode, the **frost protection function** is always enabled. As soon as the actual temperature drops below 8°C, the temperature is controlled in the selected operating mode to 8°C.

Two-point control mode: The upper rotary switch sets the required difference between the switch-on and switch-off temperatures.

When the actual temperature \geq reference temperature, the device is switched off.

When the actual temperature \leq (reference temperature - hysteresis), the device is switched on.

The signs are the opposite in cooling mode.

The type of connected actuators will be selected **with the lower rotary switch**. **SA NC** for actuator NC (normally closed) or **SA NO** for actuator NO (normally open).

When **wireless window/door contacts FTK** or **window handle sensors FFG7B** are taught-in, they are OR linked. If one or more windows are open, the output remains off. In heating mode, however, the frost protection remains enabled.

When **motion detectors FBH** are taught-in, they are AND linked. If all FBHs signal 'No motion', the device switches to standby setback mode: In heating mode, the reference temperature is set back by 2°; in cooling mode, it is raised by 2°. As soon as a motion detector signals movement again, the device is switched to normal mode.

When the **FBHs and wireless pushbuttons** are taught-in, the last telegram received is always the one that is valid. An FBH therefore switches off a setback mode selected by means of the wireless pushbutton when motion is detected.

When a **wireless pushbutton** is taught-in, the 4 keys are assigned the following functions:

Top right: Normal mode (can also be enabled by timer with the function 'ON'). Bottom right: Night setback mode by 4°; in cooling mode: increase by 4° (can also be enabled by timer with the function 'OFF'). Top left: Standby setback mode by 2°, in cooling mode, increase by 2°. Bottom left: Off (in heating mode, frost protection enabled; in cooling mode permanent off).

Malfunction mode: If no wireless telegram will be received from a temperature sensor for more than 1 hour, the LED lights up and it will be switched to fault mode: in heating mode it will be switched on for 1.2 minutes and switched off for 2.8 minutes at PWM 1. At PWM 2 and 2-Pt the times are 4.5 minutes 'on' and 10.5 minutes 'off'. The device is switched off in cooling mode. When a wireless telegram is again received, the LED goes out and the device switches back to normal mode.

The LED below the upper function rotary switch performs during the teach-in process according to the operating instructions. It shows control commands by short flickering during operation.

Function rotary switches

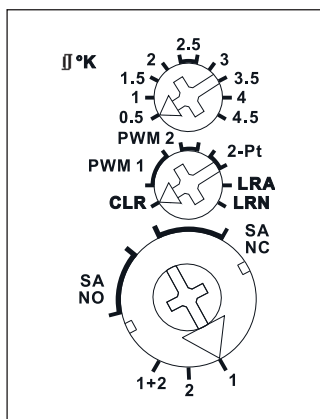

Standard setting ex works.

Further settings can be made using the PC Tool PCT14 (see page 1-5).



Manuals and documents in further languages:
<http://eltako.com/redirect/FAE14LPR>

Housing for operating instructions GBA14 page 1-49.

FAE14LPR	RS485 bus actuator single room control, heating/cooling for 2 zones with PCB relay	Art. No. 30014030	59,60 €/pc.
-----------------	--	--------------------------	--------------------



Manuals and documents in further languages:
<http://eltako.com/redirect/TSA02NC-230V>

TSA02NC-230 V



Thermal actuator AFRISO-230 V/2 W, normally closed contact (NC).
Electrical control of hot water valves.

Actuators convert the electrical signal of room or clock thermostats in one valve stroke and control the set temperature. Connected directly to the valve or distributor top part by connecting cable and union nut. IP54. Power supply 230 V $\pm 10\%$.
 I max 200 mA, -5/+60°C.
 Stroke > 3 mm in 3-6 minutes. F ~ 90 N.

TSA02NC-230V	Thermal actuator NC contact, 230 V	Art. No. 30014034	40,10 €/pc.
---------------------	------------------------------------	--------------------------	--------------------



Manuals and documents in further languages:
<http://eltako.com/redirect/TSA02NC-24V>

TSA02NC-24V



Thermal actuator AFRISO-24 V/2 W, normally closed contact (NC).
Electrical control of hot water valves.

Actuators convert the electrical signal of room or clock thermostats in a valve stroke and control the set temperature. Connected directly to the valve or distributor top part by connecting cable and union nut. IP54. Power supply 24 V $\pm 10\%$.
 I max 230 mA, -5/+60°C.
 Stroke > 3 mm in 3-6 minutes. F ~ 90 N.

TSA02NC-24 V	Thermal actuator NC contact, 24 V	Art. No. 30014035	40,10 €/pc.
---------------------	-----------------------------------	--------------------------	--------------------



Manuals and documents in further languages:
<http://eltako.com/redirect/SAS-6TE>

SAS-6TE



Bus bar for switch mode power supply unit FSNT14 to actuators FAE14SSR and FAE14LPR.

SAS-6TE	Bus bar 6 PU	Art. No. 30014024	15,30 €/pc.
----------------	--------------	--------------------------	--------------------

BUS JUMPER CONNECTOR BBV14 AND SPACER DS14

1-44

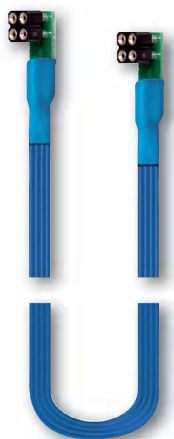

Manuals and documents in further languages:
<http://eltako.com/redirect/BBV14->

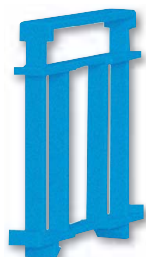

Manuals and documents in further languages:
<http://eltako.com/redirect/DS14>

BBV14



Bus jumper connector for wired connections of the bus and power supply jumpers Series 14, length of 45 cm or 100 cm. 4-core wire with soldered plugs on both sides.

The bus jumper connector BBV14 can connect bus parts on different rails.

To connect DIN-Rail devices of Series 14 with cross-wiring and bus power supply with jumpers on different rails in a cabinet or distributor with minimum space, bus jumper connectors can be plugged at the end and the beginning of the next device series.

If longer connections are required, FBA14 bus coupler should be used.

BBV14	Bus jumper connector, 45 cm long	Art. No. 30014053	24,30 €/pc.
BBV14/100	Bus jumper connector, 100 cm long	Art. No. 30014058	25,50 €/pc.

DS14



Spacer

1/2 module wide = 9 mm, to produce and maintain a ventilation clearance for modular devices dissipating much heat, e.g. dimmers and switching power supply units.

DS14	Spacer	Art. No. 30014101	2,10 €/pc.
-------------	--------	--------------------------	-------------------

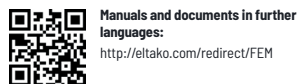

Manuals and documents in further languages:
<http://eltako.com/redirect/FEM>

FGW14 see page 1-35.

* see page 1-4

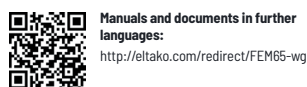

Manuals and documents in further languages:
<http://eltako.com/redirect/FEM65-wg>

FGW14 see page 1-35.

FEM



Wireless receiver antenna module for the RS485 sub-bus. Only 0.5 watt standby loss.

SMA socket for small enclosed antenna. The reception range can be increased by placing a larger wireless antenna FA250*, FA200* or FAG55E- in the optimised position.

Housing dimensions L x W x H: 78 x 40 x 22 mm.

Up to three wireless receiver modules in a separate mini-housing can be installed at any point in the building in addition to an FAM14 (see page 1-3) and connected via a Gateway FGW14 to the main bus by a 4-wire screened sub-bus line (e.g. telephone line).

Therefore connect the terminals RSA/RSB of the FEM with the terminals RSA2/RSB2 of the FGW14 (see page 1-35).

Also connect the terminals +12 V/GND of the FEM with the terminals +12 V/GND of the FGW14.

Wiring of several FEM should take place with a line in the form of a chain, as prescribed in RS485 bus systems.

A radial wiring with one line per FEM is not allowed.

In each of the three wireless receiver modules, the jumper must be plugged into a different position.

For this purpose, carefully open the housing on the narrow side with a screwdriver at the side provided.

Blade width 6.5 mm, max. 1.5 mm thick.

FEM	Wireless receiver antenna module	Art. No. 30014016	95,40 €/pc.
------------	----------------------------------	--------------------------	--------------------

FEM65-wg



Wireless receiver antenna module for the RS485 sub-bus. In the housing for surface mounting 84 x 84 x 30 mm into the E-Design switching system. Only 0.5 watt standby loss.

The mounting plate can be screwed over a flush-mounting box with a screw spacing of 60 mm.

Up to three wireless receiver modules FEM and/or FEM65 can be installed at any point in the building in addition to a FAM14 (see page 1-3) and connected via a gateway FGW14 (see page 1-35) to the main bus by a 4-wire screened sub-bus line (e.g. telephone line).

FEM65-wg	Wireless receiver antenna module surface mounting, pure white glossy	Art. No. 30065016	95,70 €/pc.
-----------------	--	--------------------------	--------------------

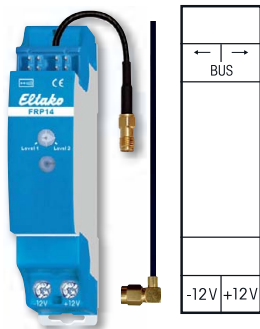

Manuals and documents in further languages:
<http://eltako.com/redirect/FRP14>

Housing for operating instructions GBA14 page 1-49.

FRP14



1 and 2 level wireless repeater with small antenna. Only 0.6 watt standby loss. If required, a wireless antenna FA250 can be connected.

Modular device for DIN-EN 60715 TH35 rail mounting.

1 module = 18 mm wide, 58 mm deep.

This repeater is only needed if the building conditions prevent undisturbed reception or the distance between the wireless pushbutton and receiver is too great.

Antenna FA250 with a 250 cm cable or FAG55E- with a 100 cm cable can be connected instead of the enclosed small antenna. When positioned in the optimal location, it can increase range considerably. The 1-level mode is activated ex works. Only the signals from sensors and actuators are received, tested and retransmitted at full transmit power. Wireless signals from other repeaters are ignored to reduce the data volume.

In de-energized state it can be switched to 2-level mode with a rotary switch. After switching on the supply voltage, the wireless signals of another 1-level repeater are now being processed.

A signal can then be received and amplified maximum 2 times.

Wireless repeaters need not be taught-in. They receive and amplify signals from all wireless sensors within their reception area.

The LEDs under the rotary switch indicate all the wireless signals detected by briefly flashing.

The wireless repeater FRP14 can be installed either as a single device in a subdistributor panel. It then requires a 12 V power supply from a wide-range power supply unit WNT15-12VDC/24W. Or it is installed together with remote Series 14 wireless actuators and cross-wiring requires a jumper.

There is no connection to the bus. It is only looped through.

FRP14	RS485 bus 1 and 2 level wireless repeater	Art. No. 30014019	90,80 €/pc.
--------------	---	--------------------------	--------------------

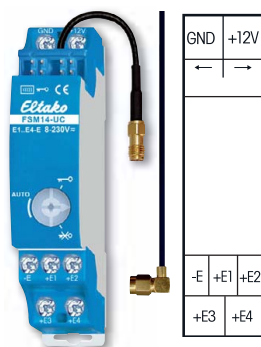

Manuals and documents in further languages:
<http://eltako.com/redirect/FSM14-UC>

Housing for operating instructions GBA14
 page 1-49.

FSM14-UC



1-47

Wireless 4-fold transmitter module. With exchangeable antenna. If required, a wireless antenna FA250 or FAG55E- can be connected. Only 0.1 watt standby loss.

Modular device for DIN-EN 60715 TH35 rail mounting.

1 module = 18 mm wide, 58 mm deep.

Connection to the Eltako-RS485 bus. Bus cross wiring and power supply with jumper. Alternatively, the power supply can be performed with a switching power supply unit 12 V DC at the terminals +12 V/GND.

This wireless transmitter module has four channels and, like a wireless 4-way pushbutton, it can transmit wireless telegrams into the Eltako wireless network. E1 initiates a wireless telegram like 'press rocker above' of a wireless pushbutton with one rocker, E2 like 'press rocker below', E3 like 'press left rocker above' of a wireless pushbutton with double rocker and E4 like 'press left rocker below' of a wireless pushbutton with double rocker.

The telegram on opening the control contacts is identical like 'release wireless pushbutton'.

Several wireless transmitter modules must not be switched at the same time.

The universal control voltage at +En/-E processes control commands from 8 to 253 V AC or 10 to 230 V DC with a length of at least 0.2 seconds. Max. parallel capacitance (approx. length) of control lead at 230 V 0.9 µF. This corresponds to a length of approx. 3000 meters.

If the terminals E1 and E2 are connected with a bridge, the wireless telegram is transmitted from E2, as long as the control voltage is applied, e.g. for central commands with priority.

The rotary switch is required for the activation or deactivation of encryption and is set to AUTO in operation.

Activate encryption: Turn the rotary switch to the right stop (position key) and press once.

Deactivate encryption: Turn the rotary switch to the left stop (position crossed out key) and press once.

FSM14-UC	RS485 bus wireless 4-fold transmitter module	Art. No. 30014048	75,20 €/pc.
----------	--	-------------------	-------------



Trennbrücke TB14



Manuals and documents in further languages:
http://eltako.com/redirect/FSNT14-12V*12W

Housing for operating instructions GBA14 page 1-49.

FSNT14-12V/12W



Switching power supply unit rated capacity 12 W. Standby loss 0.2 watt only.

Modular devices for DIN 60715 TH35 rail mounting. 1 module = 18 mm wide, 58 mm deep.

If the total power demand of a Series 14 bus system is higher than 8 W, other switching power supply units FSNT14-12V/12W are required. These are each supplying a group of actuators, which are separated with a disconnecting link on the FSNT14.

The scope of delivery includes 1 disconnecting link TB14 1 module, 1 jumper 1.5 modules and a spacer DS14. At a load of more than 50% of the rated capacity and always if there are adjacent switching power supply units and dimmers a ventilation clearance of 1/2 module must be maintained with the spacers DS14.

Therefore, this and a long jumper are included to the dimmers.

Input voltage 230 V (-20% to +10%). Efficiency 83%.

Stabilised output voltage $\pm 1\%$, low residual ripple. Short-circuit proof.

Overload protection and over-temperature switch-off by means of switching off with automatic switching-on after fault clearance (autorecovery function).

This switching power supply unit can also be used for producing a redundancy. Therefore only 1 FSNT14 should be plugged in parallel to the integrated power supply units into the FAM14 and FTS14KS and connected to a normal jumper. For an optimal load distribution, the FSNT14 should be placed as close as possible next to the last bus actuator.

FSNT14-12V/12W	Switching power supply unit 12V/12W	Art. No. 30014062	55,60 €/pc.
-----------------------	-------------------------------------	--------------------------	--------------------



Manuals and documents in further languages:
<http://eltako.com/redirect/GBA14>



Manuals and documents in further languages:
<http://eltako.com/redirect/STS14>



Manuals and documents in further languages:
<http://eltako.com/redirect/SMW14>

GBA14



Housing for operating instructions.

Modular device for DIN-EN 60715 TH35 rail mounting.

1 module = 18 mm wide, 55 mm deep.

Housing without front panel to insert operating instructions.

GBA14	Housing for operating instr., white-blue	Art. No. 30014100	5,30 €/pc.
-------	--	-------------------	------------

STS14



Set of jumpers for Series 14, 7 pieces.

STS14	Set of jumpers for Series 14, 7 pieces	Art. No. 30014038	14,20 €/pc.
-------	--	-------------------	-------------

SMW14



Tool for mounting/dismounting of bus jumpers RS485 Series BR14.

SMW14	Bus jumper tool	Art. No. 30000017	1,50 €/pc.
-------	-----------------	-------------------	------------

MAXIMUM CONFIGURATION OF THE SERIES 14 RS485 BUS WITH 3 DIFFERENT GATEWAYS AND 3 WIRELESS RECEIVER MODULES

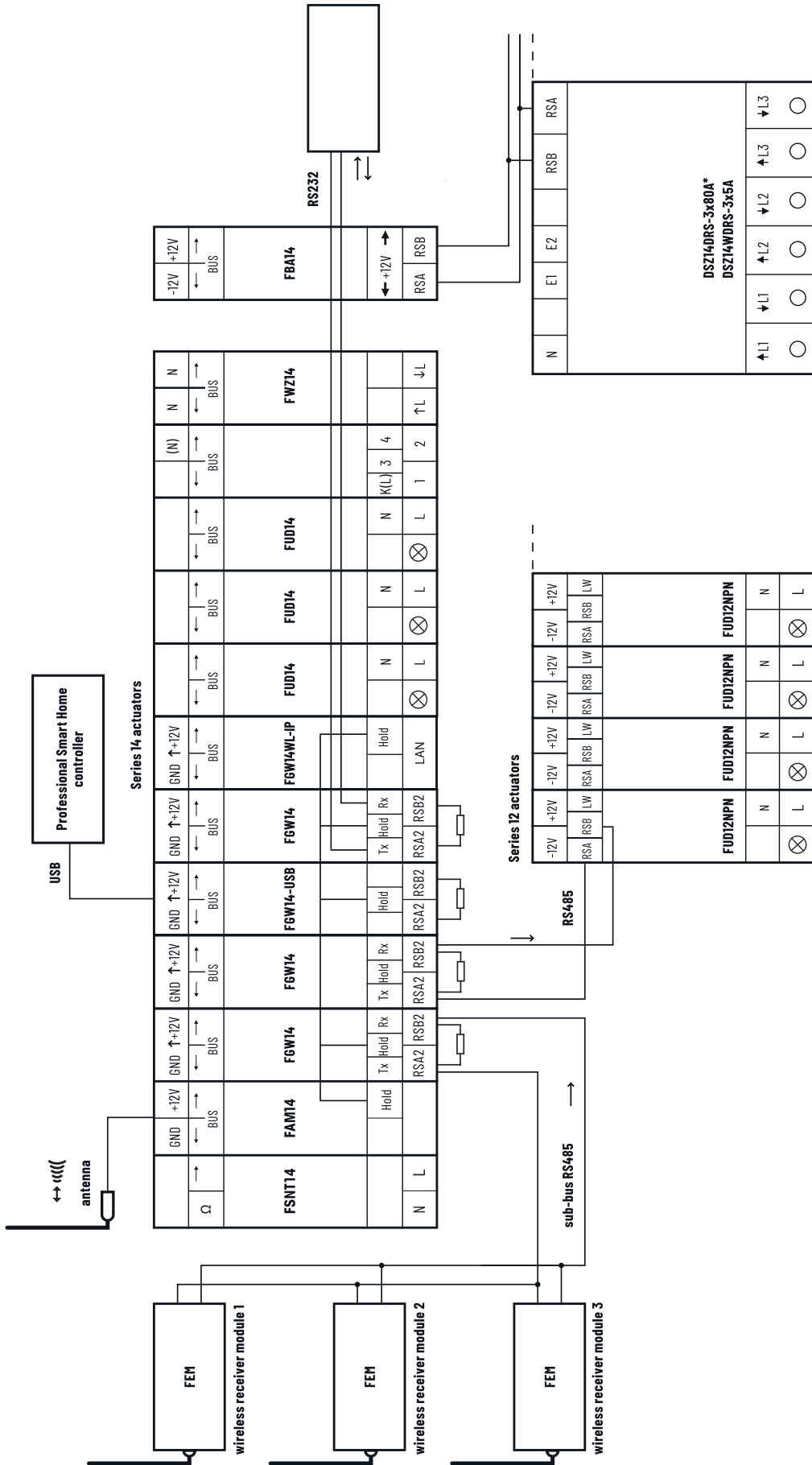

* Three-phase energy meters DSZ14 must be connected to the end of a bus line. The enclosed second terminating resistor has to be plugged to the last actuator of the FAM14 or the terminating resistor can be clamped under the terminals RSB/RSA of the last energy meter (120 Ω, not included).

CONNECTION EXAMPLE WIRELESS ANTENNA MODULE WITH DOWNSTREAM ACTUATORS AND METERS

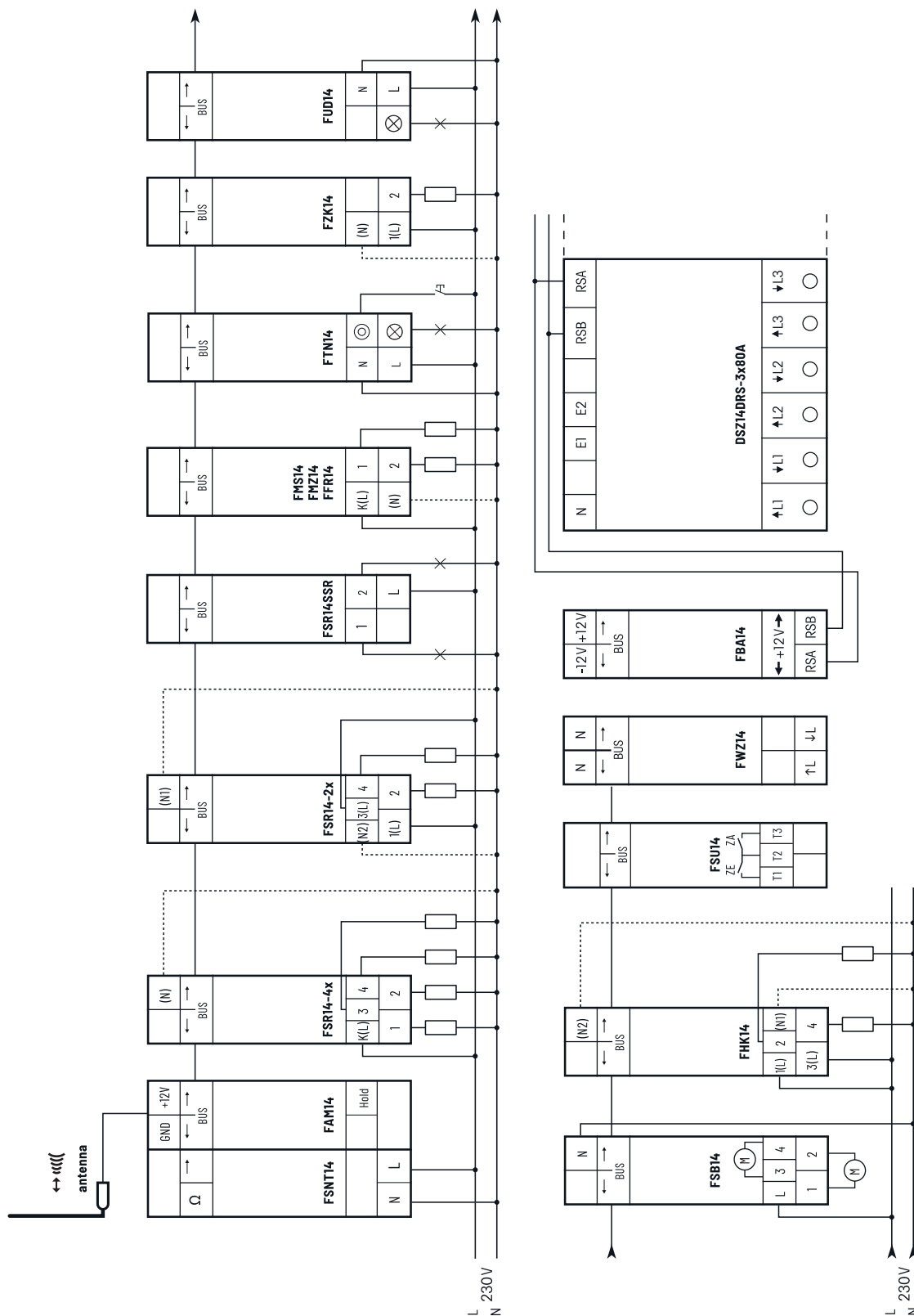

The enclosed second terminating resistor has to be plugged to the last actuator of the FAM14 or the terminating resistor can be clamped under the terminals RSB/RSA of the last energy meter (120Ω, not included).

TECHNICAL DATA - SWITCHING ACTUATORS AND DIMMING ACTUATORS FOR THE ELTAKO RS485 BUS

1-52

Type	F4HK14 FHK14 FSB14 FSR14-4x	FUD14 ¹⁾ FUD14/800W ¹⁾⁷⁾ FRGBW14	FSG14/1-10V ^{b)}	F2L14 ^{b)} F4SR14-LED FFR14, FMS14 FMZ14, FSR14-2x ^{b)} FTN14 ^{b)} FSR14M-2x ^{b)}	FSR14SSR
Contacts					
Contact material/contact gap	AgSnO ₂ /0.5 mm	Power MOSFET	AgSnO ₂ /0.5 mm	AgSnO ₂ /0.5 mm	Opto-Triac
Test voltage control connections/contact	-	-	-	2000 V	4000 V
Rated switching capacity each contact	4A/250 V AC	-	600 VA ⁵⁾	16A/250V AC; FMZ14: 10A/250V AC F4SR14: 8A/250 V AC	up to 400 W ⁶⁾
230 V LED lamps ⁹⁾	up to 200 W	Trailing edge up to 400 W Leading edge up to 100 W FUD14/800W: Trailing edge up to 800 W Leading edge up to 200 W	-	up to 400 W FSR14M: up to 600 W I on ≤ 120A/5 ms	up to 400 W ⁶⁾
Dimmable LED lamps 12-24 V DC		FRGBW14: 4 x 4 A			
incandescent lamps and halogen lamp load 230 V ²⁾	1000 W I on ≤ 10A/10 ms	up to 400 W; FUD14/800W: up to 800 W ¹⁾³⁾⁴⁾	-	2000 W F4SR14: 1800 W I on ≤ 70A/10 ms	up to 400 W ⁶⁾
Fluorescent lamp load with KVG* in lead-lag circuit or non compensated	500 VA	-	-	1000 VA	-
Fluorescent lamp load with KVG* shunt-compensated or with EVG*	250 VA, I on ≤ 10A/10 ms	-	600 VA ⁵⁾	500 VA	up to 400 VA ⁶⁾
Compact fluorescent lamps with EVG* and energy saving lamps ESL	up to 200 W ⁹⁾	up to 400 W ⁹⁾¹⁾	-	bis 400 W ⁹⁾	up to 400 W ⁶⁾⁹⁾
Inductive load cos φ = 0,6/230 V AC inrush current ≤ 35 A	650 W ⁸⁾	-	-	650 W ⁸⁾	-
Max. switching current DC1: 12 V/24 V DC	4 A	-	-	8 A (nicht FTN14 und FZK14)	-
Life at rated load, cos φ = 1 or for incandescent lamps 500 W at 100/h	>10 ⁵	-	>10 ⁵	>10 ⁵	∞
Service life at rated load, cos φ = 0,6 at 100/h	>4x10 ⁴	-	>4x10 ⁴	>4x10 ⁴	∞
Max. operating cycles	10 ³ /h	-	10 ³ /h	10 ³ /h	10 ³ /h
Maximum conductor cross-section (3-fold terminal)	6 mm ² (4 mm ²)	6 mm ² (4 mm ²)	6 mm ² (4 mm ²)	6 mm ² (4 mm ²)	6 mm ²
Two conductors of same cross-section (3-fold terminal)	2.5 mm ² (1.5 mm ²)	2.5 mm ² (1.5 mm ²)	2.5 mm ² (1.5 mm ²)	2.5 mm ² (1.5 mm ²)	2.5 mm ² (1.5 mm ²)
Screw head	slotted/cross-head, pozidriv	slotted/crosshead, pozidriv	slotted/cross-head, pozidriv	slotted/crosshead, pozidriv	slotted/cross-head, pozidriv
Type of enclosure/terminals	IP50/IP20	IP50/IP20	IP50/IP20	IP50/IP20	IP50/IP20
Electronics					
Time on	100%	100%	100%	100%	100%
Max./min. temperature at mounting location	+50°C/-20°C	+50°C/-20°C	+50°C/-20°C	+50°C/-20°C	+50°C/-20°C
Standby loss (active power)	0.1 W	0.3 W	0.5 W	0.05-0.5 W	0.1 W
Local control current at 230V control input	-	-	-	5 mA	-
Max. parallel capacitance (approx. length) of local control lead at 230 V AC	-	-	-	FTN14: 0.3 μF (1000 m)	-

* EVG = electronic ballast units; KVG = conventional ballast units

¹⁾ Bistable relay as relay contact. After installation, wait for short automatic synchronisation before teaching-in the wireless pushbuttons.

²⁾ If the load exceeds 200 W (FUD14/800W:400W), a ventilation clearance of 1/2 pitch unit to adjacent devices must be maintained via the spacer DS14.

³⁾ Applies to lamps of max. 150 W.

⁴⁾ Per dimmer or capacity enhancer it is only allowed to use max. 2 inductive (wound) transformers of the same type, **furthermore no-load operation on the secondary part is not permitted. The dimmer might be destroyed.** Therefore do not permit load breaking on the secondary part. Operation in parallel of inductive (wound) and capacitive (electronic) transformers is not permitted!

⁵⁾ When calculating the load a loss of 20% for inductive (wound) transformers and a loss of 5% for capacitive (electronic) transformers must be considered in addition to the lamp load.

⁶⁾ Fluorescent lamps or LV halogen lamps with electronic ballast.

⁷⁾ Applies to one contact and the sum of both contacts.

⁸⁾ Capacity increase for all dimmable lamp types with Capacity Enhancer FLUD14.

⁹⁾ All actuators with 2 contacts: Inductive load cos φ = 0.6 as sum of both contacts 1000 W max.

¹⁰⁾ Generally applies to 230 V LED lamps and energy saving lamps (ESL). Due to different lamp electronics, switch on/off problems and a restriction in the maximum number of lamps, however, the dimming ranges may be limited depending on the manufacturer; in particular when the connected load is very low (e.g. with 5 W LEDs). The dimmer switch comfort settings EC1, EC2, LC1, LC2 and LC3 optimise the dimming range, however, the maximum power is then only up to 100 W. In these comfort settings, no inductive (wound) transformers may be dimmed.

The second terminating resistor has to be plugged to the last actuator included in the FAMI4 respectively FTS14KS scope of supply.

Eltako Wireless is based on the EnOcean wireless standard for 868 MHz, frequency 868.3 MHz, data rate 125 kbps, modulation mode ASK, max. transmit power 7 dBm (<10 mW).

Compliance with: EN 61000-6-3, EN 61000-6-1 and EN 60669

POWER REQUIREMENT OF THE 12 V DC POWER SUPPLY OF SERIES 14

The switching power supply unit in the FAM14 resp. FTS14KS provides 12 V DC/12 W*. The maximum power consumption of each connected device must be added to calculate the total power consumption of the 12 V DC power supply.

Device	Maximum power requirement (existing relay energized)
BGW14	0.30 W
F2L14	0.14 W
F3Z14D	0.10 W
F4HK14	0.70 W
F4SR14-LED	1.00 W
FAE14LPR	0.42 W
FAE14SSR	0.40 W
FAM14	0.80 W
FBA14	-
FDG14	0.40 W
FGSM14	0.20 W
FGW14	0.50 W
FGW14W-IP/FGW14WL-IP	0.80 W
FGW14-USB	0.30 W
FHK14	0.42 W
FLUD14	-
FMS14	0.63 W
FMSR14	0.10 W
FMZ14	0.40 W
FPLG14	0.40 W
FPLT14	0.40 W
FRGBW14	0.10 W
FRP14	0.50 W
FSB14	0.42 W
FSDG14	0.40 W
FSG14/1-10V	0.20 W
FSM14	0.10 W
FSR14-2x	0.14 W
FSR14-4x	0.70 W
FSR14M-2x	0.14 W
FSR14SSR	0.40 W
FSU14	0.14 W
FTD14	0.53 W
FTN14	0.14 W
FTS14EM	0.13 W
FTS14FA	0.50 W
FTS14KS	0.40 W
FTS14TG	0.42 W
FUD14	0.20 W
FUD14/800W	0.20 W
FWG14MS	0.30 W
FWZ14-65A	0.10 W
STE14	-

* If the power requirement is greater, a switching power supply unit FSNT14-12V/12W should be used for each 12 watts of more power. Furthermore a disconnecting link TB14 has to be attached instead of a normal jumper to separate the additionally powered group.

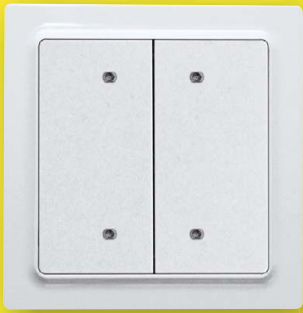
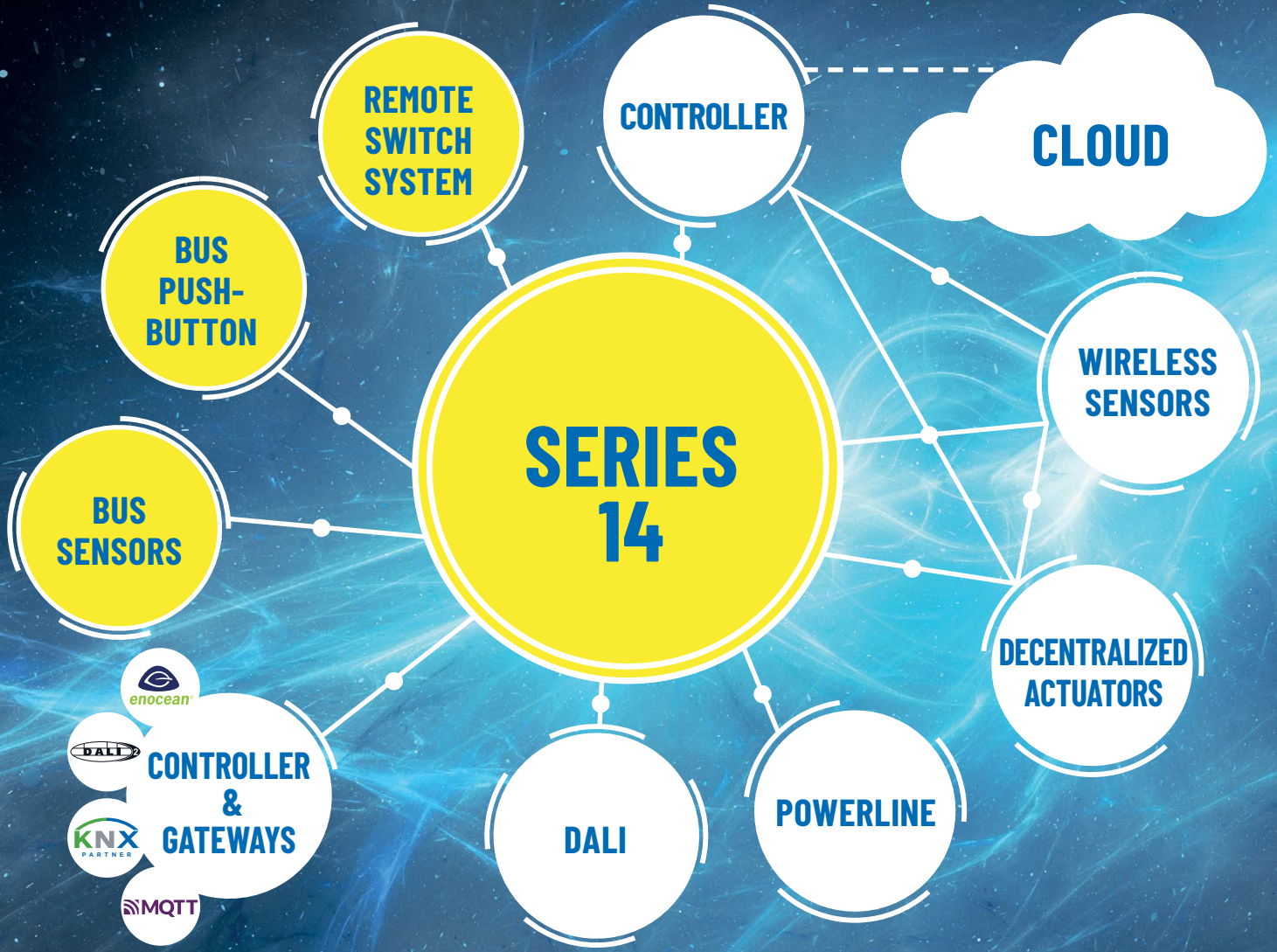

**B4T55E-wg
BUTH55ED/
12V DC-wg
FTS14EM**

2

THE REMOTE SWITCH SYSTEM AND WIRED BUS PUSHBUTTONS

The remote switch system FTS14 - Modular RS485 bus

The remote switch system FTS14 - modular RS485 bus of the next generation	2-2
RS485 bus communication interface FTS14KS	2-4
RS485 bus pushbutton input module FTS14EM	2-5
RS485 bus wireless output module FTS14FA	2-6
NEW Power supply unit 12V/12W FSNT14-12V/12W and wide-range power supply unit WNT15-12VDC/24W	2-7
RS485 bus pushbutton gateway FTS14TG	2-8
Bus pushbutton in E-Design55 B4T55E-	2-9
Bus pushbutton coupler FTS61BTK and Bus pushbutton coupler FTS61BTKL	2-10
Bus pushbutton coupler FTS61BTK/8	2-11
The input module FTS14EM with Series 14 actuators	2-12
The input module FTS14EM with actuators in combination with FAM14 to expand the Wireless Building	2-13
The wireless output module FTS14FA with FTS14TG , FTS14EM and actuators	2-14
The pushbutton gateway FTS14TG with bus pushbutton coupler FTS61BTK and bus pushbuttons B4T55E	2-15
All possible combinations FTS14KS , FAM14 , FTS14TG , FTS14EM and FTS14FA and actuators	2-16

Wired bus pushbuttons for connection to the bus gateway BGW14

NEW RS485 bus gateway BGW14 and wide-range power supply unit WNT15-12VDC/24W	2-17
Bus motion/brightness sensor BBH55E/12V DC-	2-18
Bus temperature controller with hand wheel BTR55EH/12V DC-	2-18
Bus thermo clock/hygrostat with display BUTH55ED/12V DC-	2-18
Bus temperature sensor BTF55E/12V DC-	2-18
Circuit diagrams for bus gateway BGW14 with 4-wire sensors	2-19

THE REMOTE SENSING SYSTEM FTS14 USES THE NEW FEATURES OF OUR SERIES 14

2-2

The bus and power supply connections on the input module FTS14EM, communication interface FTS14KS and actuators as DIN rail mounted devices are very simply cross-wired by means of jumpers. A customary screened 4-wire telephone line acts as bus line to connect several distributors together.

The FTS14 bus and the input module FTS14EM use exactly the same telegram structure as the Wireless Building DIN rail mounted devices of the Series 14 and are therefore directly combinable with actuators and other components in the Series 14. All the necessary functions of current production are then immediately available.

The power supply in the FTS14KS decouples the electronics of all connected devices from the 230 V power supply grid. As a result, the devices are not exposed to voltage peaks and other faults which are becoming increasingly frequent on mains power supplies. This protection significantly increases the expected service life of the devices.

Every FTS14EM with only two pitches width has 10 inputs for either conventional pushbuttons, window/door-contacts or motion sensors. Thanks to the electrically isolated universal control voltage from 8 to 230V UC, the inputs can be controlled either directly with the mains voltage or with low voltage. A separate switch mode power supply unit, e.g. the WNT15 which is only one pitch unit wide, must then be used for 12 V. Control power requirement is only 0.05 watts per pushbutton when a pushbutton is operated. All input terminals (E1 to E10) are arranged in the lower terminal blocks and a terminal for the common pushbutton reference potential (-E) is located on the upper terminal block.

The FTS14EM can be configured by 2 rotary switches in such a way that **max. 50 FTS14EM devices** can be connected to **max. 500 pushbuttons in a bus installation**. In addition the pushbutton inputs of each FTS14EM are set by rotary switch either as universal pushbuttons or in pairs as direction pushbuttons. The telegram of each pushbutton input in the entire bus is available over the bus system simultaneously for all actuators connected. It is therefore possible to install central and group pushbuttons rapidly and using few wires. The related pushbuttons are simply taught-in in the required actuators on the bus.

The connected actuators can also be configured with the PC tool PCT14 via communication interface of the FTS14KS.

→ **Optional:** Instead of the FTS14KS a **wireless antenna module FAM14** (from the Wireless Building System), which is only two pitch units wide, can also be installed. Actuators can then be activated via the FTS14EM by wireless pushbuttons, handheld transmitters and wireless sensors as well as conventional pushbuttons. The bidirectional FAM14 also permits a controller to evaluate feedback messages from the actuators transferred by wireless. Each actuator status is then displayed and can also be changed. Connecting the HOLD terminals of all devices regulates bus access and prevents collisions.

Optional: The pushbutton gateway FTS14TG, which is only two pitch units wide, can feed telegrams from the **4-way bus pushbuttons B4T55E** and **pushbutton coupler FTS61BTK** connected by 2-wire pushbutton bus to conventional pushbuttons connected to the bus. Data transfer and power supply take place simultaneously over 2 wires only. This avoids many single pushbutton control lines. This avoids many single pushbutton control lines. An FTS14EM device is then not required.

Optional: Pushbutton telegrams on the bus can be sent directly to the Wireless Building system with a **wireless output module FTS14FA**, e.g. to control decentral actuators.

Optional: The multiple gateway FGW14, which is only one pitch unit wide, can set up connections to the controller, bus components of the previous Series 12 and an RS232 interface. In addition to this, two RS485 buses from Series 14 can be connected.

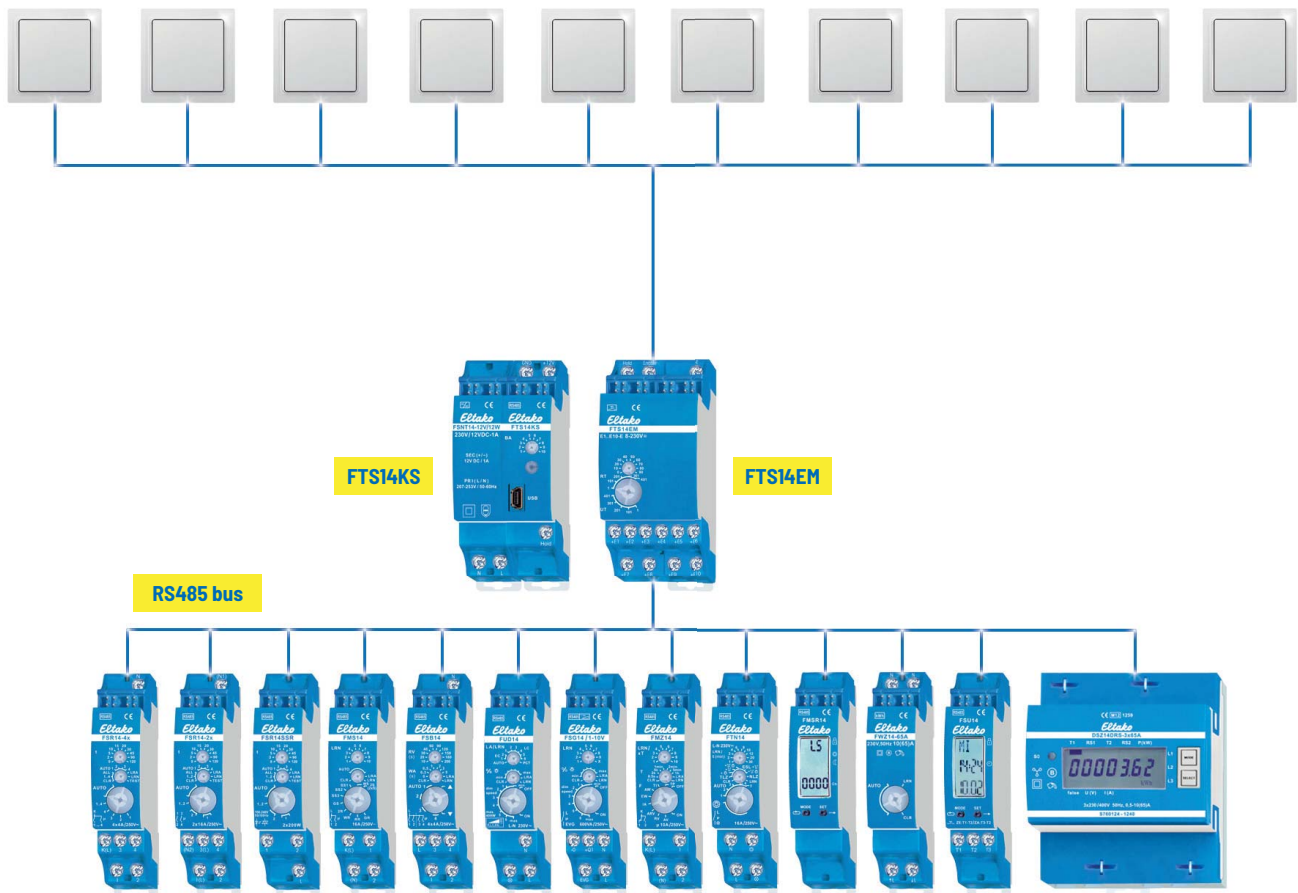

All optional possibilities can be combined as required: FTS14EM with actuators, the wireless antenna module FAM14, the pushbutton wireless output module FTS14FA and the pushbutton gateway FTS14TG for connection to pushbutton couplers FTS61BTK.

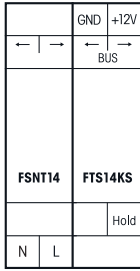

FTS14KS



FTS14 communication interface for the Eltako RS485 bus with enclosed power supply FSNT14-12V/12W. Only 0.4 watt standby loss.

Modular device for DIN-EN 60715 TH35 rail mounting. 1 module = 18 mm wide, 58 mm deep. Supply voltage 12 V DC.
Connection to the Eltako RS485 bus. Bus wiring and power supply with jumpers.
 The delivery includes 1 power supply FSNT14-12V/12W, 1 spacer DS14, 2 terminators with printing Ω, 1/2 module, 3 jumpers 1 module (including 1 spare), 1 jumper 1,5 TE, 2 jumpers 1/2 module (including 1 spare) and 1 jumper installation tool SMW14.

If the power supply is subjected to a load of more than 4 W, a ventilation distance of ½ to neighboring devices must be maintained on the left side. With a load greater than 6 W, a ½ ventilation gap is also required between the FSNT14 and the FAM14 with the DS14 spacer.

A DS14 spacer and a long jumper are therefore included. If the total power requirement of a series 14 bus system is higher than 10 W, an additional FSNT14-12V/12W must be used for every 12 W of additional power.

Bus cross wiring and power supply with jumper.

Optionally, 12 V DC of a WNT15-12VDC/24W can also be fed in at the terminals GND/+12 V.

The attached second terminator should be plugged to **the last actuator**.

Mini USB to connect to a PC, to create an equipment list, to configure the actuators using the PC tool PCT14 and for data backup. A legalization code to download the PCT14 from the Eltako homepage www.eltako.de is included in the FTS14KS.

All FTS14EM and if needed gateways FGW14 will be connected to the terminal Hold when they connect a PC with a RS232 bus.

According to the operating manual 10 different operating modes can be set with the operating mode rotary switch BA.

The bottom LED lights up green if a connection from the PC tool PCT14 was created. When reading or writing date the LED flashes green. The green LED goes out if the connection from the PC tool PCT14 was terminated.

Function rotary switch

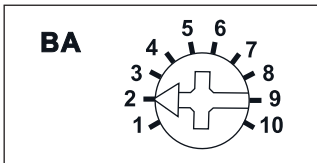

Standard setting ex works.



Manuals and documents in further languages:
<http://eltako.com/redirect/FTS14KS>

Housing for operating instructions
 GBA14 page 1-49 chapter 1.

FTS14KS	RS485 bus communication interface	Art. No. 30014065	91,50 €/pc.
----------------	-----------------------------------	--------------------------	--------------------

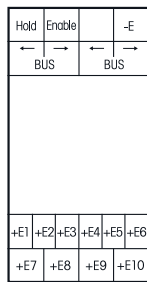

FTS14EM



Input module for the Eltako RS485 bus, 10 control inputs for universal control voltage. Only 0.1 watt standby loss.

Modular device for DIN-EN 60715 TH35 railmounting.
2 modules = 36 mm wide, 58 mm deep.

Connection to the Eltako-RS485 bus. Bus cross wiring and power supply with jumper.

Operation in conjunction with FAM14 or FTS14KS.

10 control inputs +E1 to +E10/-E electrically isolated from the supply voltage.

Control voltage: 8..230 V UC.

The control inputs can be either activated for pushbuttons (delivery state), window-door contacts or motion detectors.

From the production week 21/19 the signals of the control inputs can be inverted.

Control inputs for pushbuttons: telegrams of pushbuttons will be generated (e.g. 0x70).

Each FTS14EM can be set to UT (= universal pushbutton) or RT (= direction pushbutton) on the lower rotary switch.

Control inputs for window-door contacts: telegrams of the window-door contact FTK are generated (EEP D5-00-01). If the input is driven by the contact with the control voltage to be applied externally, the telegram 'window open' is generated. If the contact is opened, the telegram 'window open' is generated. As with the wireless sensor FTK, the status telegram is repeated every 15 minutes.

Control inputs for motion detectors: telegrams of the wireless motion/brightness sensor FBH are generated (EEP A5-08-01), wherein the brightness value is always 0. If the input is driven by the contact with the control voltage to be applied externally, the telegram 'motion' is generated. If the contact is opened, the telegram 'no motion' will be generated. As with the wireless sensors FBH, the status telegram is repeated every 15 minutes.

Each telegram of a contact input has to be taught-in with an identification number (ID) into one or more actuators according to the operating instructions.

The lower rotary switch defines the group to which an FTS14EM belongs. A total of 5 groups are available (1, 101, 201, 301 and 401) each with 100 IDs.

The upper rotary switch (0 to 90) sets the ID within a group. The ID range within a group results from the combination of upper and lower rotary switches and must be set differently on each FTS14EM. Maximum ten FTS14EMs form a group. Therefore, a total of 50 FTS14EMs comprising 500 pushbuttons or contacts are possible in one RS485 bus.

To generate the necessary **teach-in telegrams** for teaching-in into the actuators, the requested group has to be selected on the upper and lower rotary switch. For pushbuttons in the range UT or RT or for window-door contacts and motion sensors in the range RT. Then confirm the required control input.

In operation, the same group should be selected for window-door contacts and motion sensors in the range UT or RT for pushbutton or UT.

The LED below the upper rotary switch flashes briefly, when a connected contact is closed.

Optional: An **FAM14 wireless antenna module** (from Wireless Building System) which is only two modules wide can also be installed. Actuators can then be activated via the FTS14EM by wireless pushbuttons and contacts, handheld transmitters and wireless sensors in addition to conventional buttons. As the FAM14 has an integrated switch mode power supply unit, the FTS14KS is no longer required for power supply in this configuration.

The bidirectional FAM14 also permits a controller to evaluate feedback messages from the actuators transferred by wireless. Each actuator status is then displayed and can also be changed. Connecting the HOLD terminals of all devices regulates bus access and prevents collisions.

The telegrams of the FTS14EM can also be sent to the Eltako Wireless Building **with the optional wireless output module FTS14FA.**

Function rotary switches

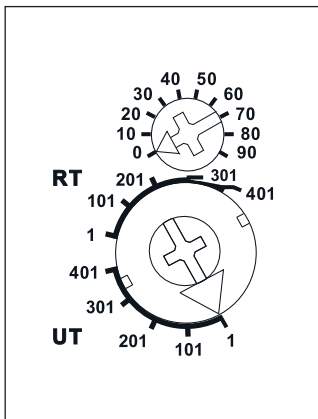

Standard setting ex works.



Manuals and documents in further languages:
<http://eltako.com/redirect/FTS14EM>

Housing for operating instructions
GBA14 page 1-49 chapter 1.

FTS14EM	RS485 bus pushbutton input module	Art. No. 30014060	68,90 €/pc.
----------------	-----------------------------------	--------------------------	--------------------

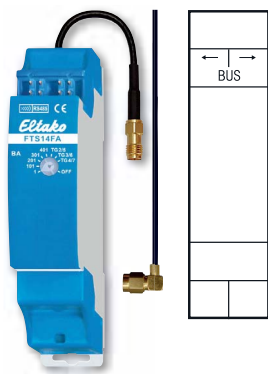

The enclosed small antenna can be replaced with a wireless antenna FA250 or if need be FA200 and FAG55E- (see page 1-4).

Function rotary switch

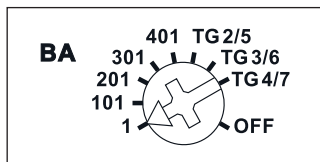

Standard setting ex works.



Manuals and documents in further languages:
<http://eltako.com/redirect/FTS14FA>

Housing for operating instructions
 GBA14 page 1-49 chapter 1.

FTS14FA



**Wireless output module for FTS14 systems with FTS14EM and/or FTS14TG.
 Only 0.5 watt standby loss.**

Modular device for DIN-EN 60715 TH35 rail mounting.
 1 module = 18 mm wide, 58 mm deep.

Connection to the Eltako-RS485 bus. Bus cross wiring and power supply with jumper.

Operation in conjunction with FTS14KS with or without FAM14.

A rotary switch defines the FTS14EM or FTS14TG group to which an FTS14FA belongs. Therefore a maximum of 8 FTS14FAs can be connected to a bus. Every telegram from an FTS14EM or FTS14TG is sent with its own ID to the Eltako building wireless system.

Rotary switch on the FTS14FA set to position 1: Sends telegrams of all FTS14EMs set to 1.

Rotary switch on the FTS14FA set to position 101: Sends telegrams of all FTS14EMs set to 101.

Rotary switch on the FTS14FA set to position 201: Sends telegrams of all FTS14EMs set to 201.

Rotary switch on the FTS14FA set to position 301: Sends telegrams of all FTS14EMs set to 301.

Rotary switch on the FTS14FA set to position 401: Sends telegrams of all FTS14EMs set to 401.

Rotary switch on the FTS14FA set to position TG2/5: Sends telegrams of all FTS14TG set to 2 or 5.

Rotary switch on the FTS14FA set to position TG3/6: Sends telegrams of all FTS14TG set to 3 or 6.

Rotary switch on the FTS14FA set to position TG4/7: Sends telegrams of all FTS14TG set to 4 or 7.

Rotary switch on the FTS14FA set to position OFF: The FTS14FA is switched off.

The green LED under the rotary switch will flash shortly when a wireless telegram is sent.

Telegrams from an FAM14 are not sent additionally by the FTS14FA.

FTS14FA	Wireless output module	Art. No. 30014063	95,40 €/pc.
---------	------------------------	-------------------	-------------

SWITCHING POWER SUPPLY UNIT 12V/12W FSNT14-12V/12W AND WIDE-RANGE POWER SUPPLY UNIT WNT15-12VDC/24W



FSNT14-12V/12W



Switching power supply unit rated capacity 12 W. Standby loss 0.2 watt only.

Modular devices for DIN 60715 TH35 rail mounting. 1 module = 18 mm wide, 58 mm deep.

If the total power demand of a Series 14 bus system is higher than 8 W, other switching power supply units FSNT14-12V/12W are required. These are each supplying a group of actuators, which are separated with a disconnecting link on the FSNT14.

The scope of delivery includes 1 disconnecting link TB14 1 module, 1 jumper 1.5 modules and a spacer DS14. At a load of more than 50% of the rated capacity and always if there are adjacent switching power supply units and dimmers a ventilation clearance of 1/2 module must be maintained with the spacers DS14.

Therefore, this and a long jumper are included to the dimmers.

Input voltage 230 V (-20% bis +10%). Efficiency 83%.

Stabilised output voltage $\pm 1\%$, low residual ripple. Short-circuit proof.

Overload protection and over-temperature switch-off by means of switching off with automatic switching-on after fault clearance (autorecovery function).

This switching power supply unit can also be used for producing a redundancy. Therefore only 1 FSNT14 should be plugged in parallel to the integrated power supply units into the FAM14 and FTS14KS and connected to a normal jumper. For an optimal load distribution, the FSNT14 should be placed as close as possible next to the last bus actuator.

Disconnecting link TB14



Manuals and documents in further languages:
http://eltako.com/redirect/FSNT14-12V*12W

Housing for operating instructions GBA14 page 1-49.

FSNT14-12V/12W	Switching power supply unit 12V/12W	Art. No. 30014062	55,60 €/pc.
-----------------------	-------------------------------------	--------------------------	--------------------



WNT15-12VDC/24W



Wide-range switching power supply unit. Rated capacity 24 W. Standby loss 0.1 watt only.

Modular devices for DIN 60715 TH35 rail mounting.

1 module = 18 mm wide, 58 mm deep.

At a load of more than 50% of the rated capacity and always if there are adjacent switching power supply units and if there are dimmers a ventilation clearance of 1/2 module must be maintained with the spacers DS12 on both sides.

Wide-range input voltage 88-264 V AC (110 V -20% up to 240 V +10%).

Efficiency 91%. Stabilised output voltage $\pm 1\%$, low residual ripple. Short-circuit proof.

Overload protection and over-temperature switch-off by means of switching off with automatic switching-on after fault clearance (autorecovery function).



Manuals and documents in further languages:
http://eltako.com/redirect/WNT15-12VDC*24W

Technical data page 17-6.

WNT15-12VDC/24W	Wide-range switching power supply unit 12 V DC	Art. No. 20000072	52,50 €/pc.
------------------------	--	--------------------------	--------------------

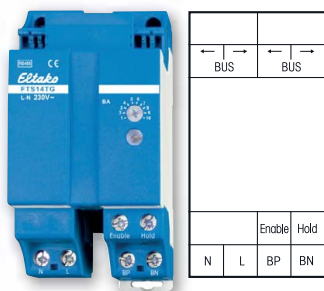

Function rotary switch

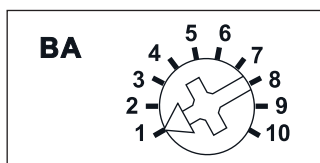

Standard setting ex works.



Manuals and documents in further languages:
<http://eltako.com/redirect/FTS14TG>



Manuals and documents in further languages:
<http://eltako.com/redirect/RLC-Glied>

Description FTS61BTK and FTS61BTKL on page 2-9.

FTS14TG



Pushbutton gateway for FTS14 systems. Only 1.3 watt standby loss.

Modular device for DIN-EN 60715 TH35 railmounting.

2,5 modules = 45 mm wide, 58 mm deep.

To improve heat dissipation, provide a ventilation gap 1/2 a pitch unit wide on the left-hand side. Use the enclosed spacer DS14 for this purpose.

Power supply 230 V.

Connection to the Eltako-RS485 bus. Bus cross wiring and power supply with jumper. Operation in conjunction with FAM14 or FTS14KS.

Using up to **3 pushbutton gateways FTS14TG**, you can feed the telegrams of up to 90 **4-way bus switches B4T55E** or **pushbutton bus couplers FTS61BTK, FTS61BTKL and FTS61BTK/8** connected over a 2-wire bus with conventional pushbuttons connected to them. Data transfer and power supply take place simultaneously over 2 wires only. This avoids a mass of single pushbutton control lines. An FTS14EM device is then not required.

Up to 30 B4T55E, FTS61BTK, FTS61BTKL and FTS61BTK/8 devices can be connected to an FTS14TG pushbutton gateway.

A voltage of 29 V DC is supplied to the connected devices over a 2-wire bus which is also used for data transfer. Please use only conventional bus or telephone lines.

The 2-wire bus is electrically isolated from the Eltako RS485 bus.

The permitted maximum line length is 200 m. The RLC device enclosed with the FTS14TG must also be connected to the terminals BP and BN on the bus switch or pushbutton bus coupler furthest away.

Pushbutton telegrams from the connected devices are transmitted by an FTS14FA device over the Eltako RS485 bus and over the Eltako building wireless system.

FTS14TG	RS485 bus pushbutton gateway	Art. No. 30014061	111,10 €/pc.
RLC element	Range extension for FTS14TG	Art. No. 30000025	6,60 €/pc.

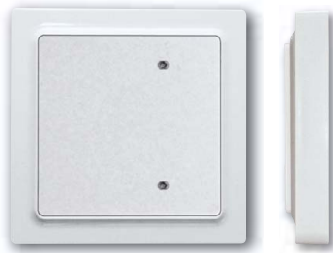

Bus pushbutton with rocker

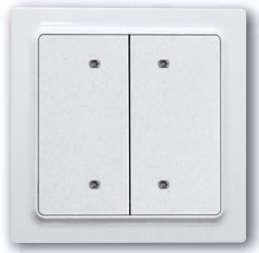

Bus pushbutton with double rocker



Manuals and documents in further languages:
<http://eltako.com/redirect/B4T55E->

B4T55E-



2-9

Bus 2- or 4-way pushbutton for single mounting or mounting into the E-Design55 switching system. 80x80, 15 mm high. For connection to FTS14TG pushbutton gateway. Only 0.2 watt standby loss. With rocker and double rocker. Smart Home sensor.

The scope of supply comprises a mounting base, an attachment frame with snapped-on electronics, a frame, a rocker and a double rocker.

The double rocker permits entry of 4 evaluable signals, but the rocker allows only 2 signals.

At the rear, a 20 cm long red/black bus line is routed externally. Red terminal to BP, black to BN of a pushbutton gateway FTS14TG.

Up to 30 bus switches and/or FTS61BTK pushbutton bus couplers can be connected to terminals BP and BN of an FTS14TG pushbutton gateway. The permitted maximum line length is 200 m. The RLC device enclosed with the FTS14TG must also be connected to the terminals BP and BN on the bus switch or pushbutton bus coupler furthest away.

A voltage of 29 V DC is supplied to the connected B4 over a 2-wire pushbutton bus which is also used for data transfer.

Please use only conventional bus or telephone lines.

Confirmation telegrams from actuators are displayed by 4 resp. 2 yellow LEDs when the actuator IDs are entered by the PCT14 in the ID table of the FTS14TG.

The mounting plate can be screwed over a flush-mounting box with a screw spacing of 60 mm.

B4T55E-am	Bus pushbutton in E-Design55, anthracite mat	Art. No. 30055650	59,80 €/pc.
B4T55E-pg	Bus pushbutton in E-Design55, polar white glossy	Art. No. 30055651	59,80 €/pc.
B4T55E-pm	Bus pushbutton in E-Design55, polar white mat	Art. No. 30055652	59,80 €/pc.
B4T55E-wg	Bus pushbutton in E-Design55, pure white glossy	Art. No. 30055653	59,80 €/pc.

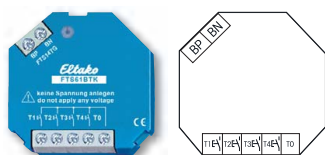

Manuals and documents in further languages:
<http://eltako.com/redirect/FTS61BTK>

Typical connections on 2-14 and 2-15.

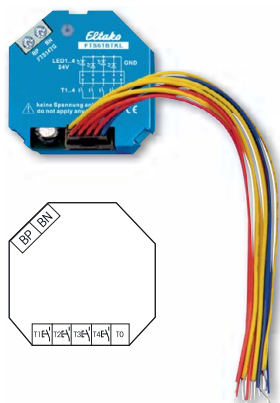

Manuals and documents in further languages:
<http://eltako.com/redirect/FTS61BTKL>

FTS61BTK



Bus pushbutton coupler FTS61BTK for 4 conventional pushbuttons for connection to FTS14TG pushbutton gateways by 2-wire pushbutton bus. Only 0.2 watt standby loss.

For installation. 45 mm long, 45 mm wide, 18 mm deep.

Up to 30 bus pushbuttons and/or bus pushbutton couplers FTS61BTK devices can be connected to the BP and BN terminals of a pushbutton gateway FTS14TG. The permitted total line length is 200 m. The RLC device enclosed with the FTS14TG must also be connected to the terminals BP and BN on the bus switch or pushbutton bus coupler furthest away.

A voltage of 29 V DC is supplied to the connected FTS61BTK over a 2-wire pushbutton bus which is also used for data transfer.

Please use only conventional bus or telephone lines.

Up to four conventional pushbuttons can be connected to T1, T2, T3 and T4 by a maximum line length of 2 metres. Connect the opposite pole to the T0 terminal in each case.

Caution: Do not apply any voltage.

The pairs T1/T3 and T2/T4 can be defined as direction pushbuttons.

Connect the bus to BP and BN. Make sure the polarity is correct.

FTS61BTK	Bus pushbutton coupler for 4 conventional pushbuttons	Art. No. 30014064	57,10 €/pc.
-----------------	---	--------------------------	--------------------

FTS61BTKL



Bus pushbutton coupler FTS61BTKL for 4 conventional pushbuttons with integrated 24 V LEDs for connection to FTS14TG pushbutton gateways by 2-wire pushbutton bus. Only 0.2 watt standby loss.

For installation. 45 mm long, 45 mm wide, 18 mm deep.

Up to 30 bus pushbuttons and/or bus pushbutton couplers FTS61BTKL devices can be connected to the BP and BN terminals of a pushbutton gateway FTS14TG. The permitted total line length is 200 m. The RLC device enclosed with the FTS14TG must also be connected to the terminals BP and BN on the bus switch or pushbutton bus coupler furthest away.

A voltage of 29 V DC is supplied to the connected FTS61BTKL over a 2-wire pushbutton bus which is also used for data transfer.

Please use only conventional bus or telephone lines.

Up to four conventional pushbuttons T1-T4 can be connected to the 15 cm long connecting cables. Each opposite pole is T0. The connecting cables can be extended up to 2 m. With the 24 V LEDs integrated in the pushbuttons, confirmation telegrams of actuators are displayed if the IDs of the actuators were registered into the ID table of the FTS14TG with PCT14.

Caution: Do not apply any voltage.

The pairs T1/T3 and T2/T4 can be defined as direction pushbuttons.

Connect the bus to BP and BN. Make sure the polarity is correct.

FTS61BTKL	Bus pushbutton coupler for 4 conventional pushbuttons for feedback LEDs	Art. No. 30014074	62,50 €/pc.
------------------	---	--------------------------	--------------------

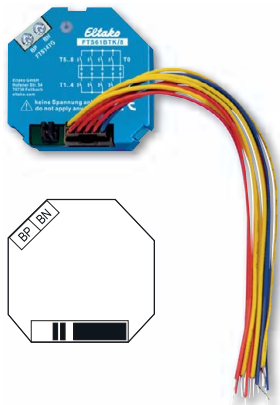

Manuals and documents in further languages:
http://eltako.com/redirect/FTS61BTK*8

FTS61BTK/8



Bus pushbutton coupler FTS61BTK/8 for 8 conventional pushbuttons for connection to FTS14TG pushbutton gateways by 2-wire pushbutton bus. Only 0.2 watt standby loss.

For installation. 45 mm long, 45 mm wide, 18 mm deep.

Up to 30 bus pushbuttons and/or bus pushbutton couplers FTS61BTK/8 devices can be connected to the BP and BN terminals of a pushbutton gateway FTS14TG. The permitted total line length is 200 m. The RLC device enclosed with the FTS14TG must also be connected to the terminals BP and BN on the bus switch or pushbutton bus coupler furthest away.

A voltage of 29 V DC is supplied to the connected FTS61BTK/8 over a 2-wire pushbutton bus which is also used for data transfer.

Please use only conventional bus or telephone lines.

Up to eight conventional pushbuttons T1-T8 can be connected to the 15 cm long connecting cables. Each opposite pole is T0. The connecting cables can be extended up to 2 m.

Caution: Do not apply any voltage.

The pairs T1/T3, T2/T4, T5/T7 and T6/T8 can be defined as direction pushbuttons.

Connect the bus to BP and BN. Make sure the polarity is correct.

FTS61BTK/8	Bus pushbutton coupler for 8 conventional pushbuttons	Art. No. 30014075	93,50 €/pc.
------------	---	-------------------	-------------

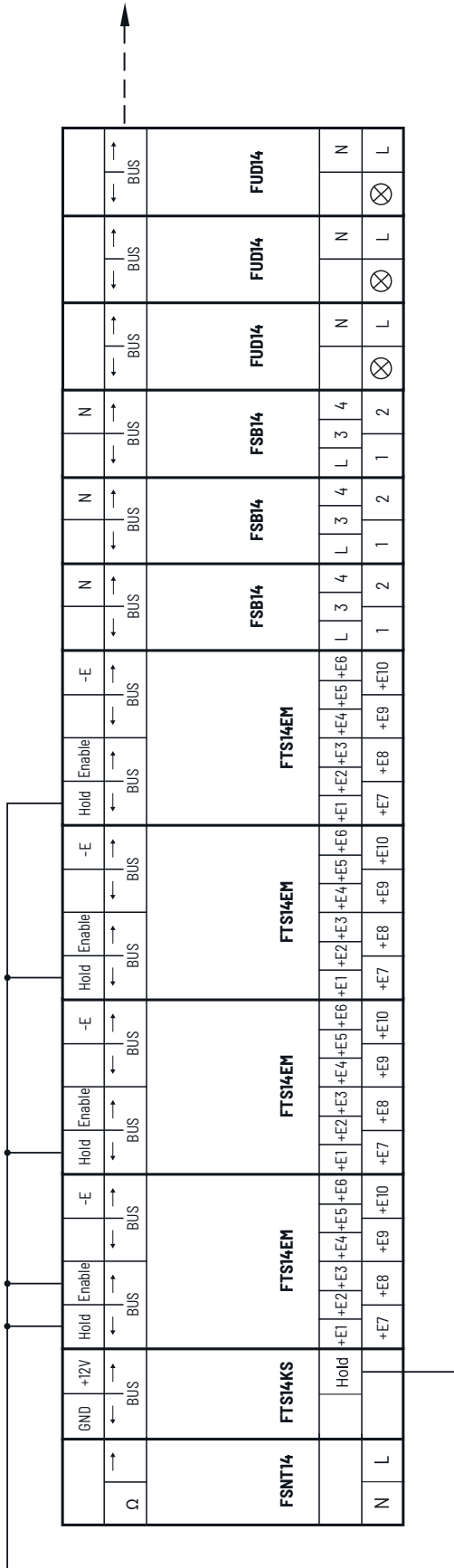

The second terminator which is included in the FTS14KS has to be plugged to the last actuator.



Control inputs FTS14EM

THE INPUT MODULE FTS14EM WITH ACTUATORS IN COMBINATION WITH FAM14 TO EXPAND THE WIRELESS BUILDING

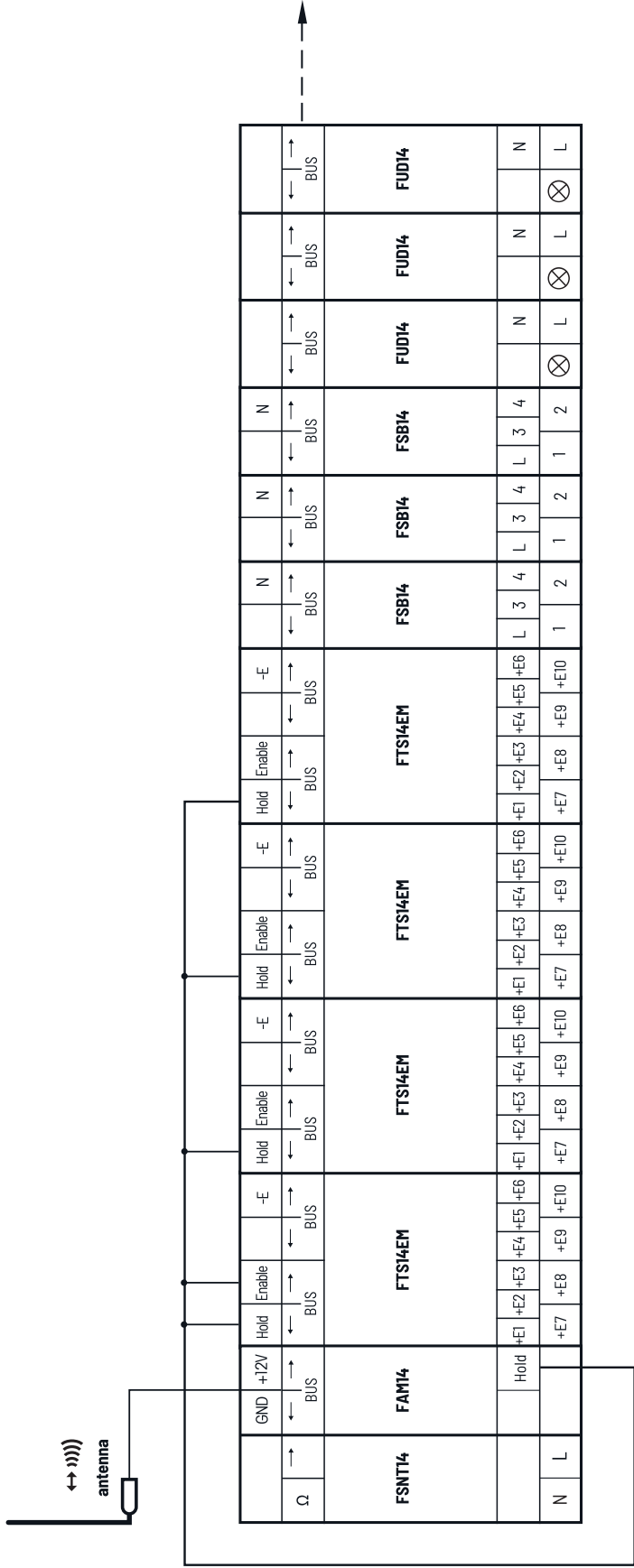

The second terminator which is included in the FAM14 has to be plugged to the last actuator.

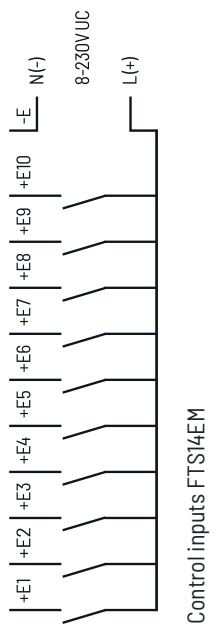

Control inputs FTS14EM

THE WIRELESS OUTPUT MODULE FTS14FA WITH FTS14TG, FTS14EM AND ACTUATORS

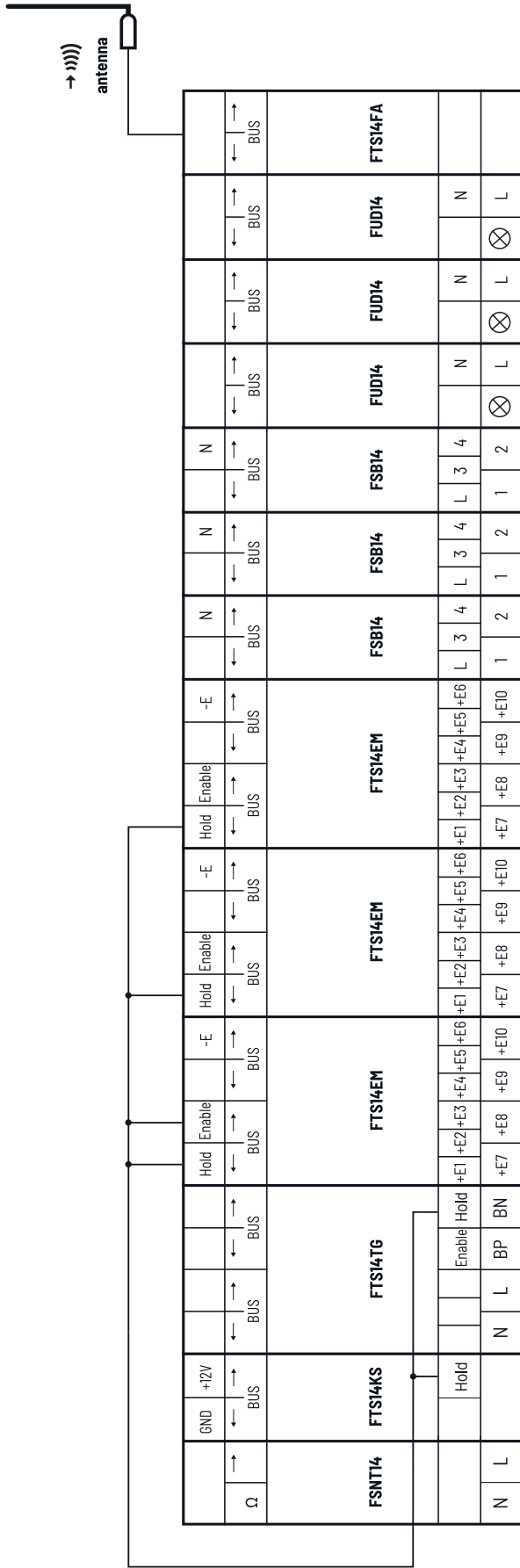

The second terminating resistor supplied with the FTS14KS must be plugged into the last bus user. Every FTS14FA generates wireless telegrams from up to 5 FTS14EM pushbutton input modules and up to 3 FTS14TG pushbutton gateways.



Control inputs FTS14EM

THE PUSHBUTTON GATEWAY FTS14TG WITH BUS PUSHBUTTON COUPLER FST61BTK AND BUS PUSHBUTTONS B4T55E

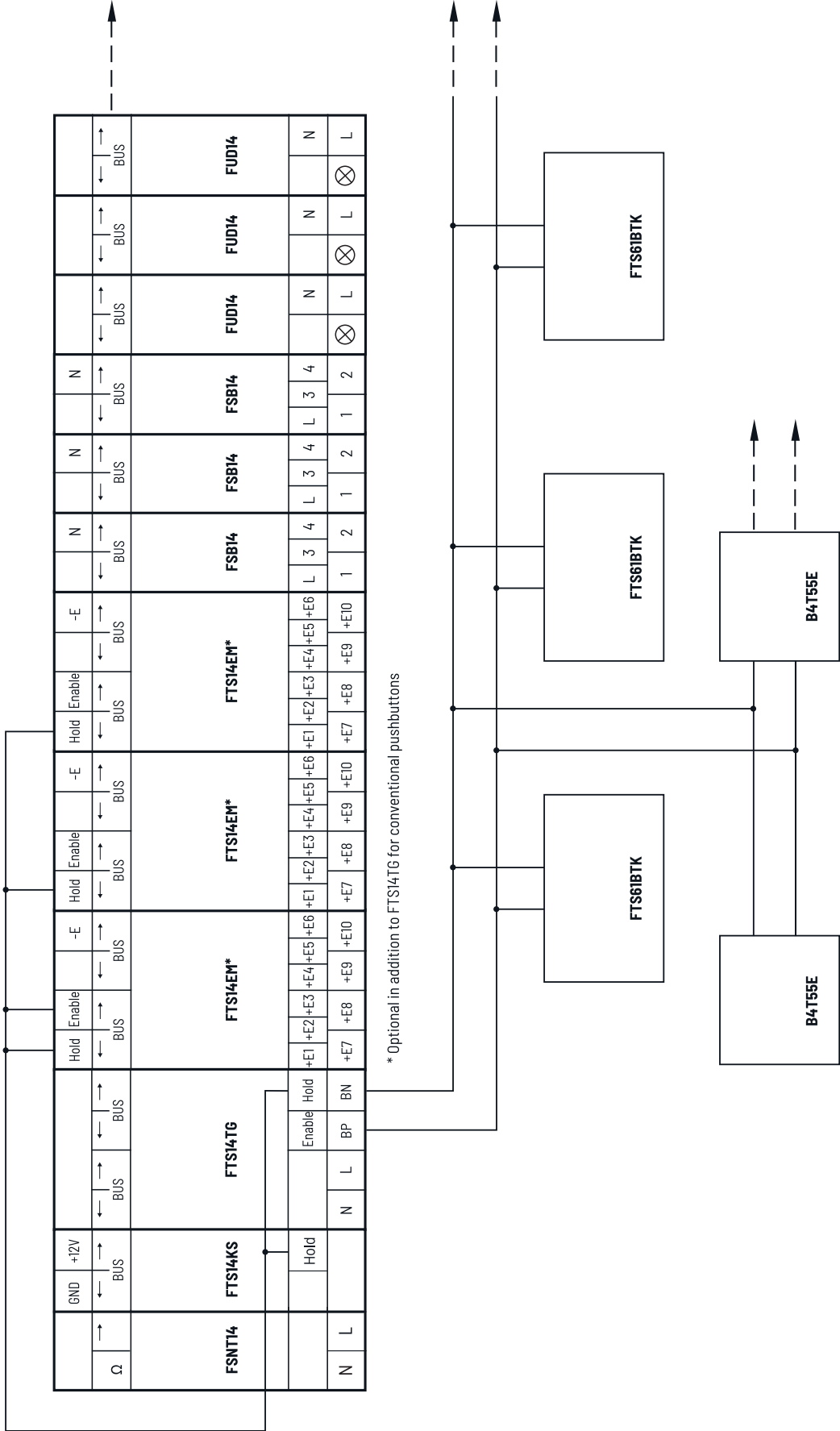

* Optional in addition to FTS14TG for conventional pushbuttons

The second terminator which is included in the FTS14KS has to be plugged to the last actuator. Up to 30 Bus pushbuttons B4T55E and decentralised bus pushbutton couplers FTS61BTK with 4 pushbutton inputs for conventional pushbuttons can be connected with a pushbutton gateway FTS14TG. A simple 2-wire circuit supplies the bus pushbutton coupler with power and also pushbutton information will be transmitted. The topology of the 2-wire connection can be chosen arbitrarily here.

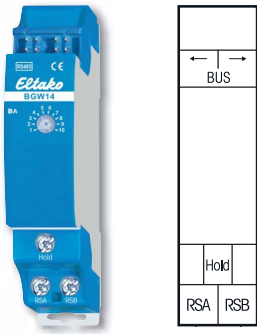

BGW14



RS485 bus gateway. Bidirectional. Only 0.3 watt standby loss.

Modular device for DIN-EN 60715 TH35 rail mounting.
1 module = 18 mm wide, 58 mm deep.

Connection to the Eltako-RS485 bus. Bus cross wiring and power supply with jumper.

Operation in conjunction with FAM14 or FTS14KS.

The Hold terminal is connected to the FAM14 or the FTS14KS.

Up to 16 RS485 sensors, e.g. 16 RS485-Sensoren BUTH55ED/12V DC, BBH55E/12V DC and BTR55EH/12V DC can be connected to the RSA/RSB terminals. See page 2-17. The data is transmitted via the 4-wire bus and the power is supplied with a 12 V DC power supply unit.

Standard telephone wire is sufficient as connecting lead: J-Y (ST) Y 2x2x0,8 mm² or equivalent.

The permitted maximum line length is 1000 m. The second 120 Ω terminal resistor must also be connected to the RSA/RSB terminals of the remotest sensor.

With up to 8 BGW14 devices, the data of up to 128 sensors can be fed to the RS485 bus.

Set the **operating mode rotary switch BA** according to the operating instructions.

Function rotary switches

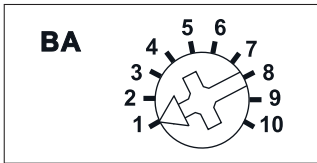

Standard setting ex works.



Manuals and documents in further languages:
<http://eltako.com/redirect/BGW14>

Housing for operating instructions GBA14 page 1-48 chapter 1.

BGW14	RS485 bus gateway	Art. No. 30014046	64,90 € / pc.
--------------	-------------------	--------------------------	----------------------



WNT15-12VDC/24W



Wide-range switching power supply unit. Rated capacity 24 W. Standby loss 0.1 watt only.

Modular devices for DIN 60715 TH35 rail mounting.
1 module = 18 mm wide, 58 mm deep.

At a load of more than 50% of the rated capacity and always if there are adjacent switching power supply units and if there are dimmers a ventilation clearance of 1/2 module must be maintained with the spacers DS12 on both sides.

Wide-range input voltage 88-264 V AC (110 V -20% up to 240 V +10%).

Efficiency 91%. Stabilised output voltage ±1%, low residual ripple. Short-circuit proof.

Overload protection and over-temperature switch-off by means of switching off with automatic switching-on after fault clearance (autorecovery function).



Manuals and documents in further languages:
http://eltako.com/redirect/WNT15-12VDC*24W

Technical data page 17-6.

WNT15-12VDC/24W	Wide-range switching power supply unit 12 V DC	Art. No. 20000072	52,50 € / pc.
------------------------	--	--------------------------	----------------------

E-DESIGN55 SENSOREN BGW14

Type	Color	Art. No.	€/pc.
------	-------	----------	-------



BBH55E/12V DC-



Bus motion/brightness sensor in E-Design55.

Bus motion/brightness sensor for connection to the RS485 bus gateway BGW14. For single mounting or mounting in the E-Design55 switch system. 80x80 mm, 27 mm high. Installation depth 33mm. Data transmission and power supply take place over the 4-wire bus with a 12V DC switching power supply unit. Only 0.1 watt standby loss. Smart Home sensor.



More informations:



http://eltako.com/redirect/BBH55E*12V_DC-

BBH55E/12V DC-am	anthracite mat	30055152	78,20
BBH55E/12V DC-pg	polar white glossy	30055153	78,20
BBH55E/12V DC-pm	polar white mat	30055154	78,20
BBH55E/12V DC-wg	polar white glossy	30055155	78,20

Type	Color	Art. No.	€/pc.
------	-------	----------	-------



BUTH55ED/12V DC-



Bus thermo clock/hygrostat with display in E-Design55

Bus thermo clock/hygrostat with display for connection to the RS485 bus gateway BGW14. For single mounting or mounting in the E-Design55 switch system. 80x80 mm, 14 mm high. Installation depth 33 mm. With adjustable day and night reference temperatures and relative humidity. Illuminated display. Preset ready to operate. Data transmission and power supply takes place over the 4-wire bus with a 12 V DC power supply unit. Only 0.1 watt standby loss. Smart Home sensor.



More informations:



http://eltako.com/redirect/BUTH55ED*12V_DC-

BUTH55ED/12V DC-am	anthracite mat	30055164	91,80
BUTH55ED/12V DC-pg	polar white glossy	30055165	91,80
BUTH55ED/12V DC-pm	polar white mat	30055166	91,80
BUTH55ED/12V DC-wg	polar white glossy	30055167	91,80



BTR55EH/12V DC-



Bus temperature controller with hand wheel in E-Design55

Bus temperature controller with hand wheel for connection to the RS485 bus gateway BGW14. For single mounting or mounting in the E-Design55 switch system. 80x80 mm, 27 mm high. Installation depth 33 mm. Data transmission and power supply takes place over the 4-wire bus with a 12 V DC power supply unit. Only 0.1 watt standby loss. Smart Home sensor.



More informations:



http://eltako.com/redirect/BTR55EH*12V_DC-

BTR55EH/12V DC-am	anthracite mat	30055160	72,70
BTR55EH/12V DC-pg	polar white glossy	30055161	72,70
BTR55EH/12V DC-pm	polar white mat	30055162	72,70
BTR55EH/12V DC-wg	polar white glossy	30055163	72,70



BTF55E/12V DC-



Bus-Temperatur-Fühler im E-Design55

Bus temperature sensor for connection to the RS485 bus gateway BGW14. For single mounting or mounting in the E-Design55 switch system. 80x80 mm, 17 mm high. Installation depth 33 mm. Data transmission and power supply takes place over the 4-wire bus with a 12 V DC power supply unit. Only 0.1 watt standby loss. Smart Home sensor.



More informations:



http://eltako.com/redirect/BTF55E*12V_DC-

BTF55E/12V DC-am	anthracite mat	30055156	66,80
BTF55E/12V DC-pg	polar white glossy	30055157	66,80
BTF55E/12V DC-pm	polar white mat	30055158	66,80
BTF55E/12V DC-wg	polar white glossy	30055159	66,80

WIRING DIAGRAMS

THE BUS GATEWAY BGW14 WITH 4 WIRE SENSORS

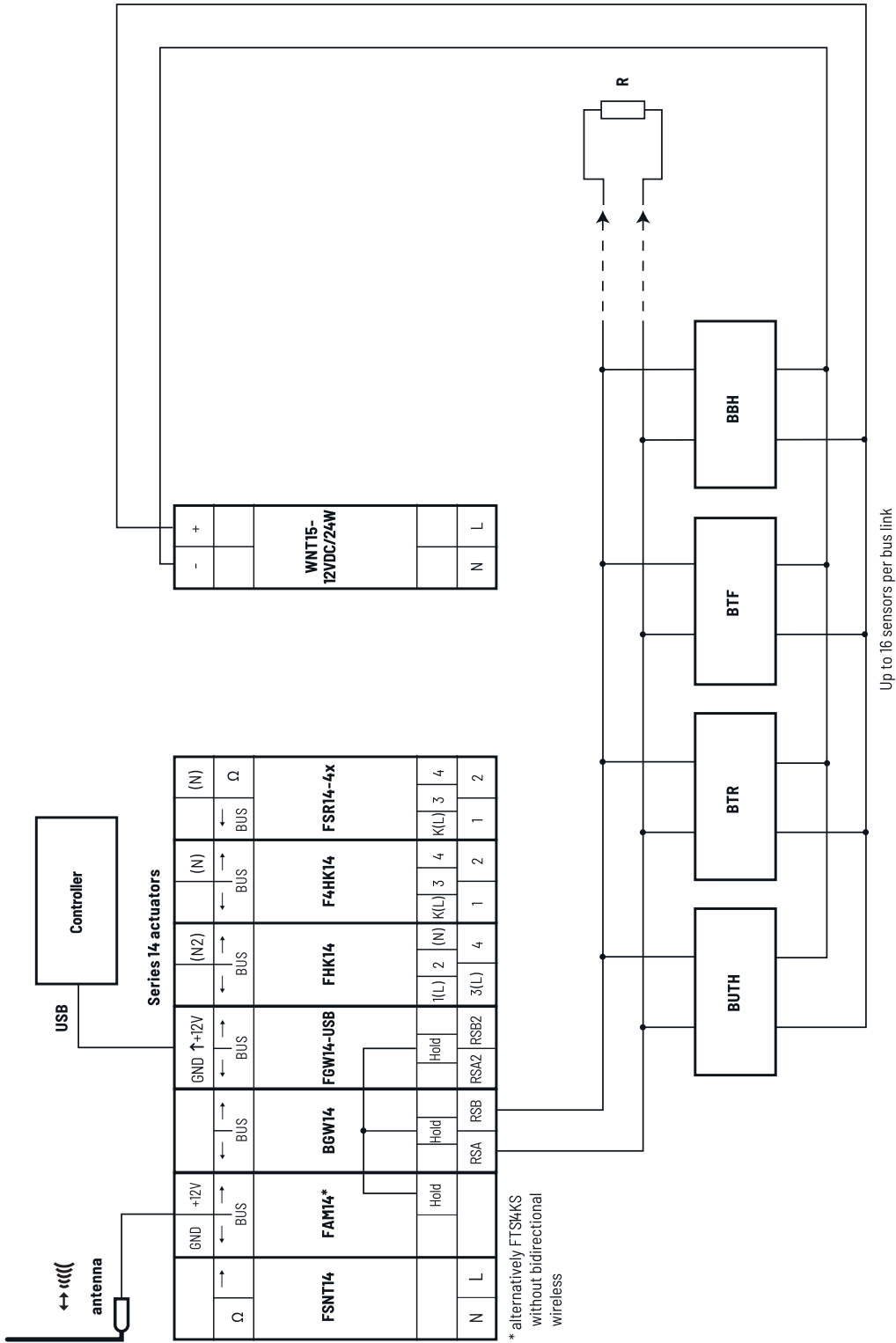

The second terminating resistor included with the BGW14 must also be connected to the RSA/RSB terminals on the last bus sensor.

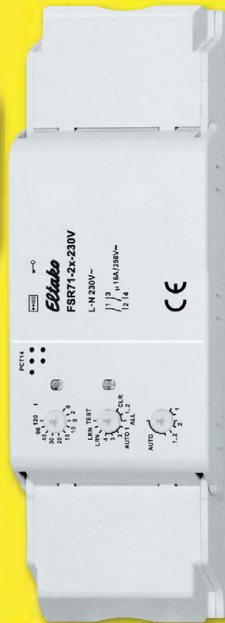
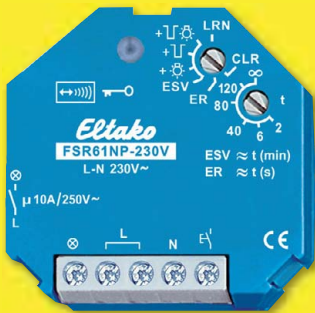
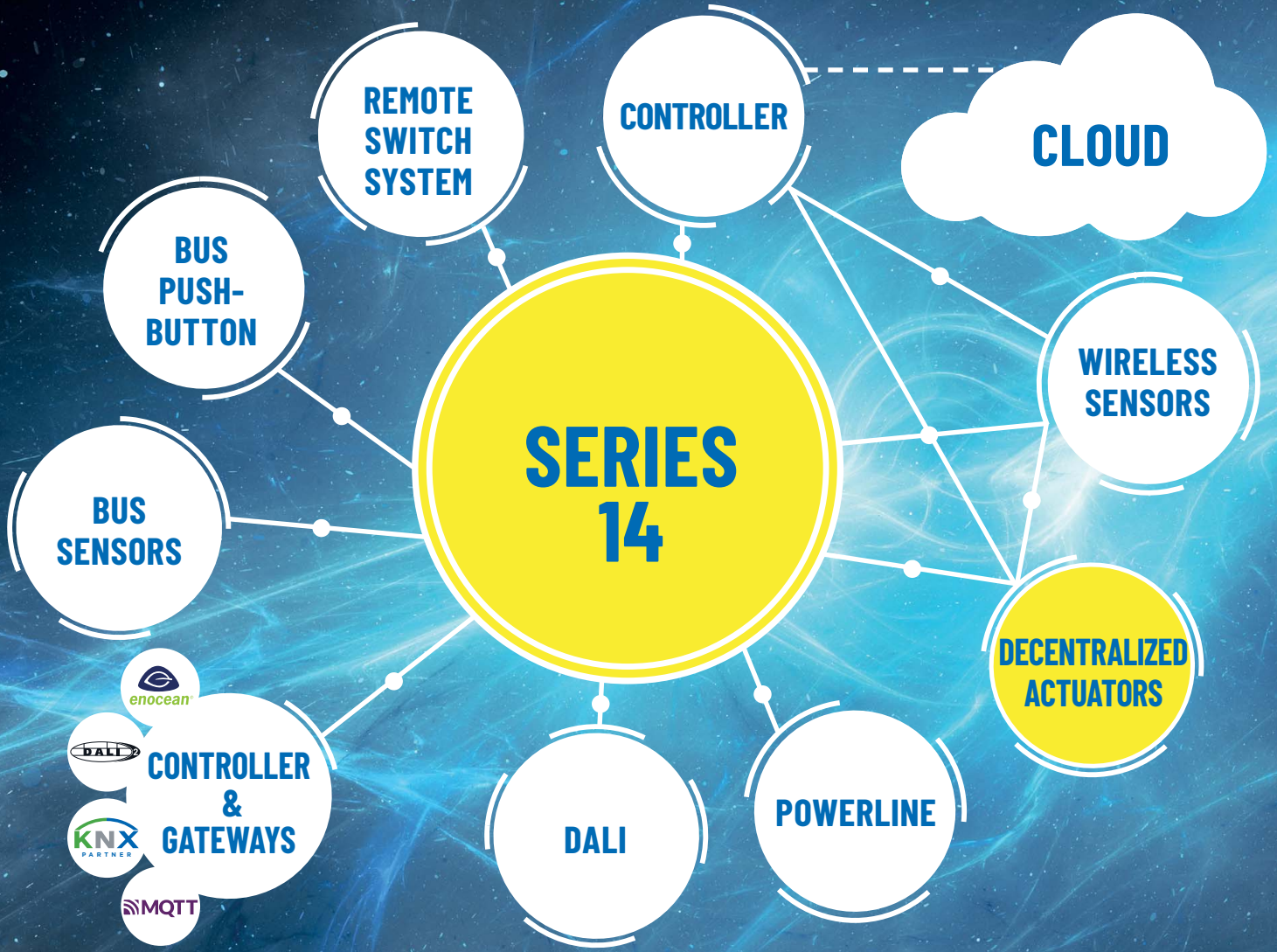

**FSR61NP
FD62NPN
FSR71**

3

FLUSH MOUNTING SWITCHING AND DIMMING ACTUATORS FOR DECENTRALISED INSTALLATION.

Wireless actuators for the decentralised Wireless Building installation

Wireless relay actuator FR62-230V and FR62NP-230V	3-3
Wireless light actuator FL62-230V and FL62NP-230V	3-4
Wireless universal dimming actuator without N terminal FD62NP-230V	3-5
Wireless universal dimming actuator FD62NPN-230V	3-5
Wireless DALI gateway FDG62-230V and DALI2 bus power supply unit 80 mA for flush-mounted box DL-N2-80mA	3-6
Wireless shading element and roller shutter actuator FJ62/12-36V DC	3-7
Wireless shading element and roller shutter actuator FJ62NP-230V	3-8
Wireless repeater FRP62-230V	3-9
Wireless actuator for extractor hoods control with window/door contact FDH62NP-230V+FTKB	3-10
Wireless sensor window/door contact FTKB-wg	3-10
Blisterpack switching BPS55-L62	3-11
Blisterpack dimming BPD55-D62 and blisterpack switching BPB55-J62	3-12
Wireless actuator impulse switch with integr. relay function FSR61NP-230V	3-13
Wireless actuator impulse switch with integr. relay function FSR61/8-24V UC	3-14
Wireless actuator impulse switch with integr. relay function FSR61-230V	3-15
Wireless actuator impulse switch with integr. relay function noiseless FSR61G-230V	3-16
Wireless actuator impulse switch with integr. relay function FSR61LN-230V for bipolar switching of L and N	3-17
Wireless actuator multifunction impulse switch FMS61NP-230V	3-18
Wireless actuator light controller FLC61NP-230V	3-19
Wireless actuator universal dimmer switch without N FUD61NP-230V	3-20
Wireless actuator universal dimmer switch FUD61NPN-230V	3-21
Wireless actuator constant current LED dimmer switch FKLD61	3-22
Wireless actuator PWM LED dimmer switch FLD61	3-23
Wireless actuator for shading elements and roller shutters FSB61-230V	3-24
Wireless actuator for shading elements and roller shutters FSB61NP-230V	3-25
Wireless actuator staircase time switch and off-delay timer FTN61NP-230V	3-26
Wireless actuator multifunction time relay FMZ61-230V	3-27
Wireless actuator heating/cooling relay FHK61-230V	3-28
Wireless actuator heating/cooling relay FHK61U-230V	3-29
Wireless actuator heating/cooling relay with solid state relay FHK61SSR-230V	3-30
Accessories: 1- and 2-level wireless repeater FRP61-230V	3-31
Blisterpack switching BPS55	3-32
Blisterpack dimming BPD55	3-33
Blisterpack shading BPB55	3-34
Wireless transmitter module FSM61-UC and wireless 4-way universal transmitter module F4USM61B	3-35

NEW	Wireless weather data transmitter module FWS61-24V DC , multi sensor MS and wide-range power supply unit WNT61-24VDC/10W	3 - 36
	Wireless actuator impulse switch with integr. relay function FSR71NP-230V	3 - 37
	Wireless actuator 2-channel impulse switch with integr. relay function FSR71NP-2x-230V	3 - 38
	Wireless actuator 2-channel impulse switch with integr. relay function FSR71-2x-230V	3 - 39
	Wireless actuator 4-channel impulse switch with integr. relay function FSR71NP-4x-230V	3 - 40
	Wireless actuator universal dimmer switch FUD71-230V	3 - 41
	Wireless actuator universal dimmer switch FUD71L/1200W-230V	3 - 42
	Wireless actuator dimmer switch controller FSG71 for electronic ballast 1-10 V	3 - 43
	Wireless DALI gateway FDG71L-230V	3 - 44
	Wireless actuator PWM dimmer switch for LED FRGBW71L	3 - 45
	Wireless actuator PWM dimmer switch for LED FWWKW71L	3 - 46
	Wireless actuator for shading elements and roller shutters FSB71-230V	3 - 47
	Wireless actuator for shading elements and roller shutters FSB71-2x-230V	3 - 48
	Data transformer DAT71	3 - 49
	Wireless actuator impulse switch with integr. relay function FSR70S-230V as cord switch	3 - 50
	Accessories: 1- and 2-level wireless repeater FRP70-230V and 1- and 2-level outdoor wireless repeater FARP60-230V	3 - 51
	Wireless repeater in E-Design65 FRP65/230V-wg	3 - 52
	Wireless light actuator adapter FSLA-230V	3 - 53
	Wireless actuator socket switching actuator FSSA-230V	3 - 53
	Wireless outdoor socket switch actuator FASSA-230V	3 - 54
	Wireless outdoor socket energy meter FASWZ-16A	3 - 54
	Wireless actuator socket switching actuator with current measurement FSVA-230V-10A	3 - 55
	Wireless actuator socket universal dimmer switch FSUD-230V	3 - 56
	Wireless actuator socket heating actuator FSHA-230V	3 - 57
	Wireless garage door adapter FGTZ-230V	3 - 58
	Wireless socket repeater FSRP-230V	3 - 58
	Wireless universal actuator FUA12-230V	3 - 59
	Wireless actuator wireless module FGM	3 - 60
	Wireless alarm controller with display FAC55D/230V-	3 - 60
	Wireless indoor UP signal generator FIUS55E- and wireless signal generator adapter FSSG-230V	3 - 61
	Wireless outdoor siren FAS260SA	3 - 62
	Wireless tubular motors FRM60M10 and FRM60M20	3 - 63

The Eltako wireless system works with the reliable and worldwide standardized EnOcean wireless technology in 868 MHz. It transmits ultra short and interference-proof signals with a range of up to 100 meters in halls. Eltako wireless pushbuttons reduce the electrosmog load since they emit high-frequency waves that are 100 times weaker than conventional light switches. There is also a significant reduction in low-frequency alternating fields since fewer power cables need to be installed in the building.



Typical connection

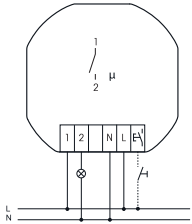

Manuals and documents in further languages:
<http://eltako.com/redirect/FR62-230V>

FR62-230V



Wireless relay actuator 10 A/250 V AC. 1 NO contact or NC contact, potential free. Standby loss only 0.4 watt.

For installation. 49 x 51 mm wide, 20 mm deep.

The terminals are plug-in terminals for conductor cross-sections of 0.2 mm² to 2.5 mm².

Up to 32 wireless pushbuttons and wireless window contacts can be taught in using easy tap technology. Bidirectional wireless switchable.

Distance between control terminals/contact 6 mm.

Supply voltage, switching voltage and control voltage local 230 V.

If supply voltage fails, the device is switched off in defined mode. When the supply voltage is restored, the device is switched off in a defined process. After installation, wait until the short automatic synchronisation takes place before the switched user is connected to the network.

In addition to the wireless control input via an internal antenna, this wireless actuator can also be controlled locally by a conventional 230 V control switch if fitted previously.

Glow lamp current is not permitted.

During teach-in, the function of the contact in quiescent position is defined as NO or NC. Closes the contact with at least one open window; it can then activate extraction hoods etc. or generate an alarm. Opens the contact with at least one open window: it can then switch off heaters or air conditioners.

Several wireless window contacts are linked together. The function is determined by the last wireless window contact which is taught in.

FR62-230V	Wireless relay actuator, 1 contact 10 A	Art. No. 30100540	65,80 €/pc.
------------------	---	--------------------------	--------------------



Typical connection

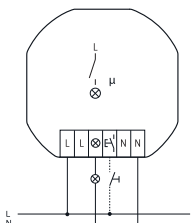

Manuals and documents in further languages:
<http://eltako.com/redirect/FR62NP-230V>

FR62NP-230V



Wireless relay actuator 10 A/250 V AC. 1 NO contact or NC contact, not potential free. Standby loss only 0.4 watt.

For installation. 49 x 51 mm wide, 20 mm deep.

The terminals are plug-in terminals for conductor cross-sections of 0.2 mm² to 2.5 mm².

Up to 32 wireless pushbuttons and wireless window contacts can be taught in using easy tap technology. Bidirectional wireless switchable.

Zero passage switching.

Supply voltage, switching voltage and control voltage local 230 V.

If supply voltage fails, the device is switched off in defined mode. When the supply voltage is restored, the device is switched off in a defined process. After installation, wait until the short automatic synchronisation takes place before the switched user is connected to the network.

In addition to the wireless control input via an internal antenna, this wireless actuator can also be controlled locally by a conventional 230 V control switch if fitted previously.

Glow lamp current is not permitted.

During teach-in, the function of the contact in quiescent position is defined as NO or NC.

Closes the contact with at least one open window; it can then activate extraction hoods etc. or generate an alarm.

Opens the contact with at least one open window: it can then switch off heaters or air conditioners.

Several wireless window contacts are linked together. The function is determined by the last wireless window contact which is taught in.

FR62NP-230V	Wireless relay actuator, 1 NO/NC contact 10 A	Art. No. 30100543	65,80 €/pc.
--------------------	---	--------------------------	--------------------

WIRELESS LIGHT ACTUATOR FL62-230V AND FL62NP-230V



FL62-230V

Wireless light actuator 10 A/250 V AC. Impulse switch with NO contact, potential free. 230 V LED lamps and ESL up to 200 W, 230 V incandescent lamps and halogen lamps 1000 W. Standby loss only 0.4 watt.

For installation. 49 x 51 mm wide, 20 mm deep.

The terminals are plug-in terminals for conductor cross-sections of 0.2 mm² to 2.5 mm².

The convenient tap technology permits the teach-in of up to 32 wireless universal pushbuttons, wireless direction pushbuttons, wireless central control pushbuttons and motion sensors.

Bidirectional wireless switchable.

Distance between control terminals and contact 6 mm.

Supply voltage, switching voltage and control voltage local 230 V.

If supply voltage fails, the device is switched off in defined mode. When the supply voltage is restored, the device is switched off in a defined process. After installation, wait for the short automatic synchronisation before connecting the switched user to the network.

In addition to the wireless control input via an internal antenna, this wireless actuator can also be controlled locally by a conventional 230 V control switch if fitted previously.

Glow lamp current is not permitted.

3-4

Typical connection

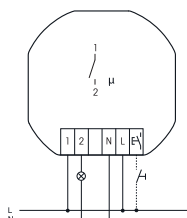

Manuals and documents in further languages:
<http://eltako.com/redirect/FL62-230V>

FL62-230V	Wireless light actuator, 1 NO contact 10 A	Art. No. 30100532	65,80 €/pc.
-----------	--	-------------------	-------------



FL62NP-230V

Wireless light actuator 10 A/250 V AC. Impulse switch with NO contact, not potential free. 230 V LED lamps and ESL up to 200 W, 230 V incandescent lamps and halogen lamps 1000 W. Standby loss only 0.4 watt.

For installation. 49 x 51 mm wide, 20 mm deep.

The terminals are plug-in terminals for conductor cross-sections of 0.2 mm² to 2.5 mm².

The convenient tap technology permits the teach-in of up to 32 wireless universal pushbuttons, wireless direction pushbuttons, wireless central control pushbuttons and motion sensors.

Bidirectional wireless switchable.

Zero passage switching.

Supply voltage, switching voltage and control voltage local 230 V.

If supply voltage fails, the device is switched off in defined mode. When the supply voltage is restored, the device is switched off in a defined process. After installation, wait for the short automatic synchronisation before connecting the switched user to the network.

In addition to the wireless control input via an internal antenna, this wireless actuator can also be controlled locally by a conventional 230 V pushbutton or switch if fitted previously.

Glow lamp current is not permitted.

Typical connection

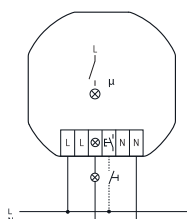

Manuals and documents in further languages:
<http://eltako.com/redirect/FL62NP-230V>

FL62NP-230V	Wireless light actuator, 1 NO contact 10 A	Art. No. 30100530	65,80 €/pc.
-------------	--	-------------------	-------------

WIRELESS UNIVERSAL DIMMING ACTUATOR WITHOUT N TERMINAL FD62NP-230V AND WIRELESS UNIVERSAL DIMMING ACTUATOR FD62NPN-230V



Typical connection

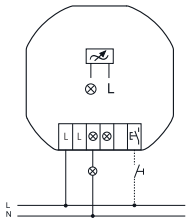

Manuals and documents in further languages:
<http://eltako.com/redirect/FD62NP-230V>

FD62NP-230V



Wireless universal dimming actuator, without N terminal. Dimmable 230 V LED lamps in 'phase cut-out' mode up to 200 W or in 'phase control' mode up to 40 W depending on ventilation conditions. Minimum load for 'phase cut-out' 20 W, or for 'phase control' 8 W. With power MOSFET. 230 V incandescent lamps and halogen lamps up to 200 W depending on ventilation conditions. No inductive (wound) transformers. With children's rooms and snooze function. No minimum load. Only 0.6 watt standby loss.

For installation. 49 x 51 mm wide, 20 mm deep.

The terminals are plug-in terminals for conductor cross-sections of 0.2 mm² to 2.5 mm².

Up to 32 wireless universal pushbuttons, wireless direction pushbuttons, wireless central control push-buttons and motion sensors can be taught in using easy tap technology.

Bidirectional wireless switchable.

Zero passage switching with soft ON and soft OFF to protect lamps.

Supply voltage, switching voltage and control voltage local 230 V.

The brightness level is stored on switch-off (memory).

If supply voltage fails, the device is switched off in defined mode.

Automatic electronic overload protection and overtemperature switch-off.

In addition to the wireless control input via an internal antenna, this wireless actuator can also be controlled locally by a conventional 230 V control switch if fitted previously.

Glow lamp current is not permitted.

FD62NP-230V	Wireless universal dimming actuator without N terminal	Art. No. 30100537	77,10 €/pc.
--------------------	--	--------------------------	--------------------



Typical connection

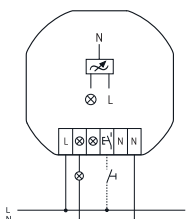

Manuals and documents in further languages:
<http://eltako.com/redirect/FD62NPN-230V>

FD62NPN-230V



Wireless universal dimming actuator. With power MOSFET. Dimmable 230 V LED lamps in 'phase cut-off' mode up to 300 W or in 'phase control' mode up to 100 W depending on ventilation conditions. 230 V incandescent lamps and halogen lamps up to 300 W depending on ventilation conditions. No inductive (wound) transformers. With children's rooms and snooze function. No minimum load. Only 0.5 watt standby loss.

For installation. 49 x 51 mm wide, 20 mm deep.

The terminals are plug-in terminals for conductor cross-sections of 0.2 mm² to 2.5 mm².

Up to 32 wireless universal pushbuttons, wireless direction pushbuttons, wireless central control push-buttons and motion sensors can be taught in using easy tap technology.

Bidirectional wireless switchable.

Zero passage switching with soft ON and soft OFF to protect lamps.

Supply voltage, switching voltage and control voltage local 230 V.

The brightness level is stored on switch-off (memory).

If supply voltage fails, the device is switched off in defined mode.

Automatic electronic overload protection and overtemperature switch-off.

In addition to the wireless control input via an internal antenna, this wireless actuator can also be controlled locally by a conventional 230 V control switch if fitted previously.

Glow lamp current is not permitted.

FD62NPN-230V	Wireless universal dimming actuator	Art. No. 30100535	75,60 €/pc.
---------------------	-------------------------------------	--------------------------	--------------------

WIRELESS DALI GATEWAY FDG62-230V AND DALI BUS POWER SUPPLY UNIT 80 MA FOR FLUSH-MOUNTED BOX DL-N2-80MA



FDG62-230V

Wireless DALI gateway, bidirectional. Only 0.5 watt standby loss.

For installation. 49 x 51 mm, 20 mm deep.

The connection terminals are plug-in terminals for conductor cross-sections from 0.2 mm² to 2.5 mm².

The convenient tap technology permits the teach-in of up to 32 wireless universal pushbuttons, wireless direction pushbuttons, wireless central control pushbuttons, motion sensors, tunable white and intensity double rocker pushbuttons.

Bidirectional wireless switchable.

Power supply 230 V at terminals N and L.

The DALI bus power supply DL-N2-80mA and up to 40 DALI devices are connected to the DALI terminals.

The gateway FDG62 controls DALI devices with Enocean wireless transmitters.

Only **broadcast commands** can be sent.

In addition to the radio control input via an internal antenna, the connected DALI devices can also be controlled with a 230 V control button that may be installed in front of the FDG62.

A glow lamp current is not permitted.

The FDG62 internally saves the dimming value and supplies this value as feedback. The same feedback telegrams are generated as for an FD62NPN.

Actuators can then be activated by the feedback signals.

The FDG62 fulfils the function of the DALI master.

FDG62-230V	Wireless DALI gateway	Art. No. 30100868	79,80 €/pc.
------------	-----------------------	-------------------	-------------



Manuals and documents in further languages:
<http://eltako.com/redirect/FDG62-230V>

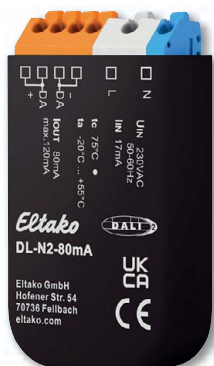

DL-N2-80mA

DALI2 bus power supply unit with 80 mA output current for supplying up to 40 standard DALI devices. 59 x 33 x 15 mm. Suitable for flush-mounted box and installation in protection class II devices.

DALI2 certified. DALI2 is the newest generation of the DALI standard with an extended range of functions.

DALI2 devices also include all previous DALI functions and are therefore backwards compatible.

The connection terminals are plug-in terminals for conductor cross-sections from 0,5 mm² to 1,5 mm².

Input: supply voltage range 120V..240V AC/50-60 Hz.

Maximum input current 10 mA. Power-up ramp-up time 250 ms. Power loss max. 2 W.

Output: Output voltage range 12 V DC..20.5 V DC. Output current 80 mA.

No-load proof and short-circuit proof.

Degree of protection housing IP40. Degree of protection terminals IP20.

Impulse voltage category II. Pollution degree 2. Rated insulation voltage 250V. Rated impulse voltage 4 kV.

Reinforced insulation. Insulation test voltage 3 kV.

Temperature at mounting location -20°C to +55°C.

Storage temperature -20°C to +75°C.

Relative humidity 15% to 90%.

DL-N2-80mA	DALI2 bus power supply unit 80 mA for flush-mounted box	Art. No. 33000026	92,60 €/pc.
------------	---	-------------------	-------------



Manuals and documents in further languages:
<http://eltako.com/redirect/DL-N2-80mA>



Typical connection

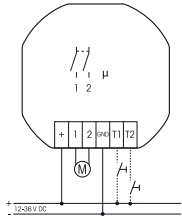

Manuals and documents in further languages:
http://eltako.com/redirect/FJ62*12-36V_DC

FJ62/12-36V DC



Wireless shading element and roller shutter actuator 1+1 NO contact, 4 A/36 V DC, not potential free, for a shading element motor 12-36 V DC. Standby loss only 0.3-0.5 watt.

For installation. 49 x 51 mm wide, 20 mm deep.

The terminals are plug-in terminals for conductor cross-sections of 0.2 mm² to 2.5 mm².

The convenient tap technology permits the teach-in of up to 32 wireless universal pushbuttons, wireless direction pushbuttons and wireless central control pushbuttons.

Bidirectional wireless switchable.

Supply voltage, switching voltage and control voltage local 12-36 V DC.

If supply voltage fails, the device is switched off in defined mode.

In addition to the wireless control input via an internal antenna, this wireless actuator can also be controlled locally by a conventional control switch if fitted previously.

Control is either by separate local control inputs for Up and Down as direction pushbuttons or these two inputs are bridged and controlled by single pushbuttons as universal pushbuttons. A change in direction then takes place by interrupting activation.

An incandescent lamp current is not permitted.

Wireless pushbuttons can be taught in with either the functions 'Up-Stop-Down-Stop' as universal pushbuttons or as local pushbuttons as well as a wireless pushbutton or roller shutter double pushbuttons can be taught in as direction pushbuttons with press top for 'Up' and bottom for 'Down'. Press briefly to stop the movement. In addition, the central control button can be taught in with static priority. The static priority is only active as long as the radio button is pressed. With a control signal, e.g. B. a radio transmitter module FSM61 with switches that has been taught-in as a central control button, the switching position 'Up' or 'Down' and the priority are specifically activated. With priority because these control signals cannot be overridden by other control signals until the central command is canceled again by the end of the control signal.

The tap reverse function can be activated: universal pushbuttons, direction pushbuttons and wired pushbuttons are initially in static mode so that the position of the blind can be adjusted.

Switched to dynamic only after activation > 1 second.

With control via controller, operating commands for up and down with the exact travel time information can be started. As the actuator reports the exact elapsed time after each activity, even when driving was triggered by a pushbutton, the position of the shading is always displayed correctly in the controller. Upon reaching the end positions above and below the position is automatically synchronized.

When a wireless window contact is taught in, a lockout protection is set up for open windows or doors to disable the Central Down and controller Down commands.

FJ62/12-36V DC	Wireless shading element and roller shutter actuator	Art. No. 30200540	72,40 €/pc.
-----------------------	--	--------------------------	--------------------

3-7



3-8

Typical connection

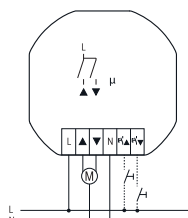

Manuals and documents in further languages:
<http://eltako.com/redirect/FJ62NP-230V>

FJ62NP-230V

Wireless shading element and roller shutter actuator 1+1 NO contact, 4 A/250 V AC, not potential free, for a shading element motor 230 V AC. Standby loss only 0.6 watt.

For installation. 49x51 mm wide, 20 mm deep.

The terminals are plug-in terminals for conductor cross-sections of 0.2 mm² to 2.5 mm².

The convenient tap technology permits the teach-in of up to 32 wireless universal pushbuttons, wireless direction pushbuttons and wireless central control pushbuttons.

Zero passage switching.

Bidirectional wireless switchable.

Supply voltage, switching voltage and control voltage local 230 V.

If supply voltage fails, the device is switched off in defined mode.

In addition to the wireless control input via an internal antenna, this wireless actuator can also be controlled locally by a conventional control switch if fitted previously.

Control is either by separate local control inputs for Up and Down as direction pushbuttons or these two inputs are bridged and controlled by single pushbuttons as universal pushbuttons. A change in direction then takes place by interrupting activation.

An incandescent lamp current is not permitted.

Wireless pushbuttons can be taught in with either the functions 'Up-Stop-Down-Stop' as universal pushbuttons or as local pushbuttons as well as a wireless pushbutton or roller shutter double pushbuttons can be taught in as direction pushbuttons with press top for 'Up' and bottom for 'Down'. Press briefly to stop the movement. In addition, the central control button can be taught in with static priority. The static priority is only active as long as the radio button is pressed. With a control signal, e.g. B. a radio transmitter module FSM61 with switches that has been taught-in as a central control button, the switching position 'Up' or 'Down' and the priority are specifically activated. With priority because these control signals cannot be overridden by other control signals until the central command is canceled again by the end of the control signal.

The tap reverse function can be activated: universal pushbuttons, direction pushbuttons and wired pushbuttons are initially in static mode so that the position of the blind can be adjusted.

Switched to dynamic only after activation > 1 second.

With control via controller, operating commands for 'up' and 'down' with the exact travel time information can be started. As the actuator reports the exact elapsed time after each activity, even when driving was triggered by a pushbutton, the position of the shading is always displayed correctly in the controller. Upon reaching the end positions above and below the position is automatically synchronized.

When a wireless window contact is taught in, a lockout protection is set up for open windows or doors to disable the Central Down and controller Down commands.

FJ62NP-230V	Wireless shading element and roller shutter actuator, 1+1 NO contact 4 A	Art. No. 30200535	66,30 €/pc.
--------------------	--	--------------------------	--------------------



Typical connection Level 1

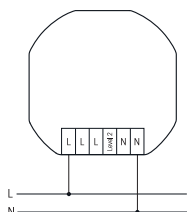

Typical connection Level 2

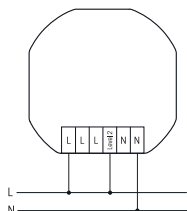

Manuals and documents in further languages:
<http://eltako.com/redirect/FRP62-230V>

FRP62-230V



1 and 2 level wireless repeaters. Only 0.7 watt standby loss.

For installation. 49 x 51 mm wide, 20 mm deep.

The terminals are plug-in terminals for conductor cross-sections of 0.2 mm² to 2.5 mm².

Supply voltage 230 V.

This repeater is only needed if the building conditions prevent undisturbed reception or the distance between the wireless pushbutton and receiver is too great.

If the supply voltage is only connected to terminals L and N, Level 1 mode is active.

Only wireless signals from sensors are received, tested and forwarded at full transmit power.

If phase is connected to the Level 2 terminal in addition to the supply voltage, Level 2 mode is active. In addition to wireless signals from sensors, the wireless signals of Level 1 repeaters are processed. A wireless signal can then be received and amplified a maximum of two times.

Wireless repeaters need not be taught in. They receive and amplify signals from all wireless sensors within their reception area.

FRP62-230V	1- and 2-level wireless repeater	Art. No. 30000534	63,70 €/pc.
-------------------	----------------------------------	--------------------------	--------------------

3-9

WIRELESS ACTUATOR FOR EXTRACTOR HOODS CONTROL WITH WIRELESS SENSOR WINDOW/DOOR CONTACT FDH62NP-230V+FTKB AND WIRELESS SENSOR WINDOW/DOOR CONTACT WITH SOLAR CELL AND BATTERY FTKB-wg



3-10

Typical connection

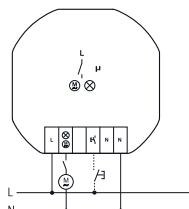

Manuals and documents in further languages:
<http://eltako.com/redirect/FDH62NP-230V+FTKB>



Manuals and documents in further languages:
<http://eltako.com/redirect/FTKB-wg>

FDH62NP-230V+FTKB



Wireless extractor hoods control. 1 NO contact not potential free 10 A/250 V AC. Only 0,4 watt standby loss. For installation. 49 x 51 mm wide, 20 mm deep.

The terminals are plug-in terminals for conductor cross-sections of 0.2 mm² to 2.5 mm².

Using easy tap technology, up to 32 wireless universal pushbuttons and wireless window contacts can be taught in.

Only sensors are allowed which report that the window is actually open or tilted. Otherwise there is a risk of poisoning!

Bidirectional wireless switchable. Supply voltage, switching voltage and control voltage local 230 V.

Zero passage switching. By using a bistable relay coil power loss and heating is avoided even in the on mode. After installation, wait for short automatic synchronisation before the switched consumer is connected to the mains. If a power failure occurs, the switching state is retained.

If supply voltage fails, the device is switched off in defined mode.

The extractor hood can only be switched on when the window is open.

If the window is closed, the relay switches the relay off.

With a radio button or a local conventional 230 V control button (a glow lamp current is not permitted), the teaching-in mode can be locked, unlocked or the memory content can be deleted.

FTKB-wg

Wireless window/door contact with solar cell and battery 75 x 25 x 12 mm, pure white glossy.

Starting at 100 Lux daylight the window/door contact FTKB powers itself from a solar cell, otherwise several years with a button cell CR2032.

On opening and closing, the related telegram is send twice in short succession. The current status telegram is sent cyclically every approx. 8 minutes.

Adhesive foil mounting.

Window/door contact dimensions l x w x h: 75 x 25 x 12 mm; magnet dimensions l x w x h: 37 x 10 x 6 mm.

FDH62NP-230V+FTKB	Wireless extractor hoods control with window/door contact, 1 NO contact 10 A	Art. No. 30100036	119,70 €/pc.
FTKB-wg	Wireless sensor window/door contact with solar cell and battery, pure white glossy	Art. No. 30000424	73,40 €/pc.



Manuals and documents in further languages:
<http://eltako.com/redirect/BPS55-L62>

BPS55-L62



Blisterpack switching with wireless pushbutton F2T55E-wg and wireless light actuator FL62-230V. Smart Home sensor and Smart Home actuator.

F2T55E-wg: Wireless 2-way pushbutton in E-Design55, 80 x 80 mm external dimensions, internal frame dimensions 55 x 55 mm, 15 mm high. Generates the power for wireless telegrams itself when the button is pressed, therefore there is no connecting wire and no standby loss. With rocker. Smart Home sensor. Wireless pushbuttons with one rocker can transmit two evaluable signals: press rocker up and press rocker down. The mounting plate can be screwed over a flush-mounting box with a screw spacing of 60 mm or screwed on a flat surface. The wireless pushbutton can be glued to the wall, on glass or on furniture using the enclosed adhesive foil.

FL62-230V: Wireless light actuator 10 A/250 V AC. Impulse switch with NO contact, potential free. 230 V LED lamps and ESL up to 200 W. 230 V incandescent lamps and halogen lamps 1000 W. For installation. 49 x 51 mm wide, 20 mm deep. Standby loss only 0.4 watt. **The terminals are plug-in terminals for conductor cross-sections of 0.2 mm² to 2.5 mm².** The convenient tap technology permits the teach-in of up to 32 wireless universal pushbuttons, wireless direction pushbuttons, wireless central control pushbuttons and motion sensors. Bidirectional wireless switchable. **Distance between control terminals and contact 6 mm.** Supply voltage, switching voltage and control voltage local 230 V. If supply voltage fails, the device is switched off in defined mode. When the supply voltage is restored, the device is switched off in a defined process. After installation, wait for the short automatic synchronisation before connecting the switched user to the network. In addition to the wireless control input via an internal antenna, this wireless actuator can also be controlled locally by a conventional 230 V control switch if fitted previously. Glow lamp current is not permitted.

3-11

BPS55-L62	Blisterpack switching	Art. No. 30001065	119,70 €/pc.
-----------	-----------------------	-------------------	--------------

BLISTERPACK DIMMING BPD55-D62 AND SHADING BPB55-J62

3-12



Manuals and documents in further languages:
<http://eltako.com/redirect/BPD55-D62>

BPD55-D62

Blisterpack dimming with wireless pushbutton F2T55E-wg and wireless universal dimming actuator FD62NPN-230V. Smart Home sensor and Smart Home actuator.

F2T55E-wg: Wireless 2-way pushbutton in E-Design55, 80 x 80 mm external dimensions, internal frame dimensions 55 x 55 mm, 15 mm high. Generates the power for wireless telegrams itself when the button is pressed, therefore there is no connecting wire and no standby loss. With rocker. Smart Home sensor. Wireless pushbuttons with one rocker can transmit two evaluable signals: press rocker up and press rocker down. The mounting plate can be screwed over a flush-mounting box with a screw spacing of 60 mm or screwed on a flat surface. The wireless pushbutton can be glued to the wall, on glass or on furniture using the enclosed adhesive foil.

FD62NPN-230V: Wireless universal dimming actuator. With power MOSFET. Dimmable LED lamps in 'phase cut-off' mode up to 300 W or in 'phase control' mode up to 100 W depending on ventilation conditions. 230 V incandescent lamps and halogen lamps up to 300 W depending on ventilation conditions. No inductive (wound) transformers. With children's rooms and snooze function. No minimum load. Only 0.5 watt standby loss. For installation. 49x51 mm wide, 20 mm deep. **The terminals are plug-in terminals for conductor cross-sections of 0.2 mm² to 2.5 mm².** Up to 32 wireless universal pushbuttons, wireless direction pushbuttons, wireless central control pushbuttons and motion sensors can be taught in using easy tap technology. Bidirectional wireless switchable. **Zero passage switching with soft ON and soft OFF to protect lamps.** Supply voltage, switching voltage and control voltage local 230 V. The brightness level is stored on switch-off (memory). If supply voltage fails, the device is switched off in defined mode. Automatic electronic overload protection and overtemperature switch-off. In addition to the wireless control input via an internal antenna, this wireless actuator can also be controlled locally by a conventional 230 V control switch if fitted previously. Glow lamp current is not permitted.



Manuals and documents in further languages:
<http://eltako.com/redirect/BPB55-J62>

BPB55-J62

Blisterpack shading with wireless pushbutton F2T55E-wg and wireless shading element and roller shutter actuator FJ62NP-230V. Smart Home sensor and Smart Home actuator.

F2T55E-wg: Wireless 2-way pushbutton in E-Design55, 80 x 80 mm external dimensions, internal frame dimensions 55 x 55 mm, 15 mm high. Generates the power for wireless telegrams itself when the button is pressed, therefore there is no connecting wire and no standby loss. With rocker. Smart Home sensor. Wireless pushbuttons with one rocker can transmit two evaluable signals: press rocker up and press rocker down. The mounting plate can be screwed over a flush-mounting box with a screw spacing of 60 mm or screwed on a flat surface. The wireless pushbutton can be glued to the wall, on glass or on furniture using the enclosed adhesive foil.

FJ62NP-230V: Wireless shading element and roller shutter actuator 1+1 NO contact, 4 A/250 V AC, not potential free, for a shading element motor 230 V AC. Standby loss only 0.6 watt. For installation. 49x51 mm wide, 20 mm deep. **The terminals are plug-in terminals for conductor cross-sections of 0.2 mm² to 2.5 mm².** The convenient tap technology permits the teach-in of up to 32 wireless universal pushbuttons, wireless direction pushbuttons and wireless central control pushbuttons. **Zero passage switching.** Bidirectional wireless switchable. Supply voltage, switching voltage and control voltage local 230 V. If supply voltage fails, the device is switched off in defined mode. In addition to the wireless control input via an internal antenna, this wireless actuator can also be controlled locally by a conventional control switch if fitted previously. Control is either by separate local control inputs for Up and Down as direction pushbuttons or these two inputs are bridged and controlled by single pushbuttons as universal pushbuttons. A change in direction then takes place by interrupting activation. An incandescent lamp current is not permitted.



BPD55-D62	Blisterpack dimming	Art. No. 30001066	136,80 €/pc.
-----------	---------------------	-------------------	--------------

BPB55-J62	Blisterpack shading	Art. No. 30001067	122,00 €/pc.
-----------	---------------------	-------------------	--------------

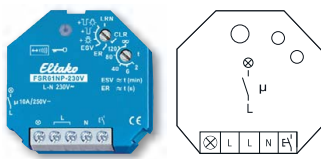

FSR61NP-230V



1 NO contact not potential free 10 A/250 V AC, 230 V LED lamps up to 400 W, incandescent lamps up to 2000 watts, off delay with switch-off early warning and switchable pushbutton permanent light. Encrypted wireless, bidirectional wireless and repeater function are switchable. Only 0.8 watt standby loss.

Function rotary switches

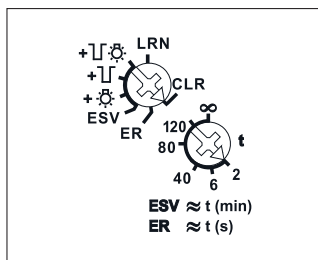

Standard setting ex works.

Typical connection

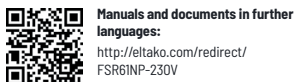
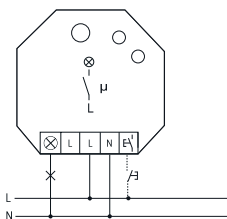

For installation. 45 mm long, 45 mm wide, 33 mm deep.

Supply voltage, switching voltage and control voltage local 230 V.

If a power failure occurs, the switching state is retained. If a power failure occurs repeatedly, the device is switched off in a defined sequence.

After installation, wait for short automatic synchronisation before the switched consumer is connected to the mains.

In addition to the wireless control input via an internal antenna, this wireless actuator can also be controlled locally by a conventional 230 V control switch if fitted previously. Glow lamp current is not permitted.

You can teach in encrypted sensors.

You can switch on **bidirectional wireless** and/or a **repeater** function.

Every change in state and incoming central command telegrams are then confirmed by a wireless telegram. This wireless telegram can be taught-in in other actuators, in controllers and in universal displays.

Scene control: several FSR61s can be switched on or off in a scene by one of the four control signals of a double-rocker pushbutton taught-in as scene pushbutton.

With the top rotary switch in the setting LRN up to 35 wireless pushbuttons can be assigned, of which one or more central control pushbuttons. In addition wireless window/door contacts with the function N/O contact or N/C contact while the window is open, wireless outdoor brightness sensors FAH and wireless motion/brightness sensors FBH. The required function of the impulse switch with integrated relay function can then be selected:

ER = switching relay

ESV = impulse switch. Possibly with off delay, then:

+ = ESV with pushbutton permanent light

+ = ESV with switch-off early warning

+ = ESV with pushbutton permanent light and switch-off early warning

If the permanent light function is switched on, the function can be activated by pressing the pushbutton for longer than 1 second. This function switches off automatically after 2 hours or by pressing the pushbutton.

If the switch-off early warning is switched on, the light starts to flicker approx. 30 seconds before time-out. This is repeated three times at decreasing time intervals.

If both switch-off early warning and pushbutton permanent light are switched on, switch-off early warning is activated before automatic switch-off of the permanent light.

The function **ESV on the bottom rotary switch** sets the off delay from 2 to 120 minutes.

In setting ∞ normal impulse switch function ES without off delay, without pushbutton permanent light and without switch-off early warning.

In setting ER = switching relay of the other rotary switch, this 2nd rotary switch fulfils a safety and power saving function in the settings except ∞ . If the switch-off command is not recognised, e.g. since the pushbutton is jammed or it was pressed too quickly, the relay switches off automatically on expiry of a time adjustable between 2 and 120 seconds. When a FTK is taught-in, this time function is turned off.

For **twilight switch** with taught-in wireless outdoor brightness sensor FAH and **motion detection** with taught-in wireless motion detector FBH see the operating instructions.

The LED performs during the teach-in process according to the operation instructions. It shows wireless control commands by short flickering during operation.

Technical data page T-3.

FSR61NP-230V	Wireless actuator Impulse switch with integr. relay function	Art. No. 30100030	92,30 €/pc.
---------------------	---	--------------------------	--------------------

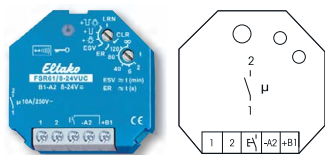

FSR61/8-24V UC



1 NO contact potential free 10 A/250 V AC, 230 V LED lamps up to 400 W, incandescent lamps up to 2000 watts, off delay with switch-off early warning and switchable pushbutton permanent light. Encrypted wireless, bidirectional wireless and repeater function are switchable. Only 0.3-0.8 watt standby loss.

For installation. 45 mm long, 45 mm wide, 33 mm deep.

Supply voltage and control voltage locally 8 to 24 V UC.

If a power failure occurs, the switching state is retained. If a power failure occurs repeatedly, the device is switched off in a defined sequence.

After installation, wait for short automatic synchronisation before the switched consumer is connected to the mains.

In addition to the wireless control input via an internal antenna, this wireless actuator can also be controlled locally by a conventional control switch if fitted previously. Glow lamp current is not permitted.

You can teach in encrypted sensors.

You can switch on **bidirectional wireless** and/or a **repeater** function.

Every change in state and incoming central command telegrams are then confirmed by a wireless telegram.

This wireless telegram can be taught-in in other actuators like the FSR61NP-230V, controllers and in universal displays.

Scene control: several FSR61s can be switched on or off in a scene by one of the four control signals of a double-rocker pushbutton taught-in as scene pushbutton.

With the top rotary switch in the setting LRN up to 35 wireless pushbuttons can be assigned, of which one or more central control pushbuttons. In addition wireless window/door contacts with the function N/O contact or N/C contact while the window is open, wireless outdoor brightness sensors FAH and wireless motion/brightness sensors FBH. The required function of the impulse switch with integrated relay function can then be selected:

ER = switching relay

ESV = impulse switch. Possibly with off delay, then:

+ ☀ = ESV with pushbutton permanent light

+ ⏏ = ESV with switch-off early warning

+ ⏏☀ = ESV with pushbutton permanent light and switch-off early warning

If the permanent light function ☀ is switched on, the function can be activated by pressing the pushbutton for longer than 1 second. This function switches off automatically after 2 hours or by pressing the pushbutton.

If the switch-off early warning ⏏ is switched on, the light starts to flicker approx. 30 seconds before time-out. This is repeated three times at decreasing time intervals.

If both switch-off early warning and pushbutton permanent light ⏏☀ are switched on, switch-off early warning is activated before automatic switch-off of the permanent light.

The function **ESV on the bottom rotary switch** sets the off delay from 2 to 120 minutes. In setting ∞ normal impulse switch function ES without off delay, without pushbutton permanent light and without switch-off early warning.

In setting ER = switching relay of the other rotary switch, this 2nd rotary switch fulfils a safety and power saving function in the settings except ∞. If the switch-off command is not recognised, e.g. since the pushbutton is jammed or it was pressed too quickly, the relay switches off automatically on expiry of a time adjustable between 2 and 120 seconds. When a FTK is taught-in, this time function is turned off.

For **twilight switch** with taught-in wireless outdoor brightness sensor FAH and **motion detection** with taught-in wireless motion detector FBH see the operating instructions.

The LED performs during the teach-in process according to the operation instructions. It shows wireless control commands by short flickering during operation.

Function rotary switches

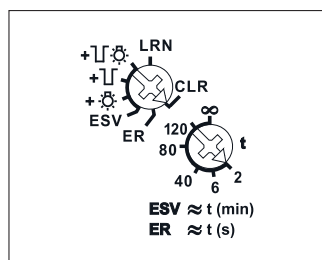

Standard setting ex works.

Typical connection

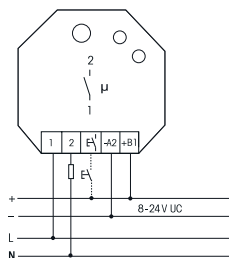

Manuals and documents in further languages:
http://eltako.com/redirect/FSR61*8-24V_UC

Technical data page T-3.

FSR61/8-24V UC	Wireless actuator Impulse switch with integr. relay function	Art. No. 30100004	90,00 €/pc.
-----------------------	---	--------------------------	--------------------

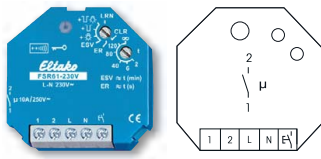

FSR61-230V



1 NO contact potential free 10 A/250 V AC, 230 V LED lamps up to 400 W, incandescent lamps up to 2000 watts, off delay with switch-off early warning and switchable pushbutton permanent light. Encrypted wireless, bidirectional wireless and repeater function are switchable. Only 0.8 watt standby loss.

3-15

Function rotary switches

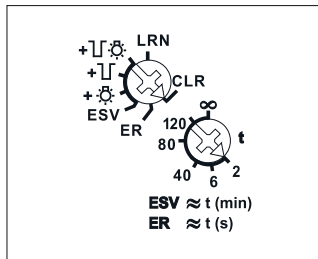

Standard setting ex works.

Typical connection

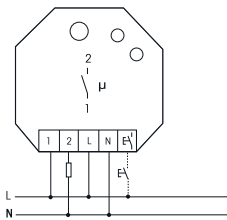

Manuals and documents in further languages:
<http://eltako.com/redirect/FSR61-230V>

For installation. 45 mm long, 45 mm wide, 33 mm deep.

Supply voltage and control voltage locally 230 V.

If a power failure occurs, the switching state is retained. If a power failure occurs repeatedly, the device is switched off in a defined sequence.

After installation, wait for short automatic synchronisation before the switched consumer is connected to the mains.

In addition to the wireless control input via an internal antenna, this universal impulse switching relay can also be controlled locally by a conventional control switch if fitted previously. Glow lamp current is not permitted.

You can teach in encrypted sensors.

You can switch on **bidirectional wireless** and/or a **repeater** function.

Every change in state and incoming central command telegrams are then confirmed by a wireless telegram. This wireless telegram can be taught-in in other actuators, controllers and in universal displays.

Scene control: several FSR61s can be switched on or off in a scene by one of the four control signals of a double-rocker pushbutton taught-in as scene pushbutton.

With the top rotary switch in the setting LRN up to 35 wireless pushbuttons can be assigned, of which one or more central control pushbuttons. In addition wireless window/door contacts with the function N/O contact or N/C contact while the window is open, wireless outdoor brightness sensors FAH and wireless motion/brightness sensors FBH. The required function of the impulse switch with integrated relay function can then be selected:

ER = switching relay

ESV = impulse switch. Possibly with off delay, then:

+ = ESV with pushbutton permanent light

+ = ESV with switch-off early warning

+ = ESV with pushbutton permanent light and switch-off early warning

If the permanent light function is switched on, the function can be activated by pressing the pushbutton for longer than 1 second. This function switches off automatically after 2 hours or by pressing the pushbutton.

If the switch-off early warning is switched on, the light starts to flicker approx. 30 seconds before time-out. This is repeated three times at decreasing time intervals.

If both switch-off early warning and pushbutton permanent light are switched on, switch-off early warning is activated before automatic switch-off of the permanent light.

The function **ESV on the bottom rotary switch** sets the off delay from 2 to 120 minutes. In setting ∞ normal impulse switch function ES without off delay, without pushbutton permanent light and without switch-off early warning.

In setting ER = switching relay of the other rotary switch, this 2nd rotary switch fulfils a safety and power saving function in the settings except ∞. If the switch-off command is not recognised, e.g. since the pushbutton is jammed or it was pressed too quickly, the relay switches off automatically on expiry of a time adjustable between 2 and 120 seconds. When a FTK is taught-in, this time function is turned off.

For **twilight switch** with taught-in wireless outdoor brightness sensor FAH and **motion detection** with taught-in wireless motion detector FBH see the operating instructions.

The LED performs during the teach-in process according to the operation instructions. It shows wireless control commands by short flickering during operation.

Technical data page T-3.

FSR61-230V	Wireless actuator Impulse switch with integr. relay function	Art. No. 30100005	90,00 €/pc.
-------------------	---	--------------------------	--------------------

WIRELESS ACTUATOR - IMPULSE SWITCH WITH INTEGRATED RELAY FUNCTION NOISELESS FSR61G-230V

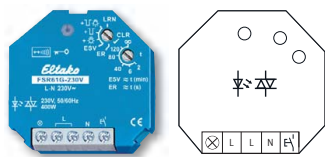

FSR61G-230V



Noiseless solid-state relay not potential-free, 230 V LED lamps up to 400 W, incandescent lamps 400 watts, off delay with switch-off early warning and switchable pushbutton permanent light. Encrypted wireless, bidirectional wireless and repeater function are switchable. Only 0.8 watt standby loss.

3-16

Function rotary switches

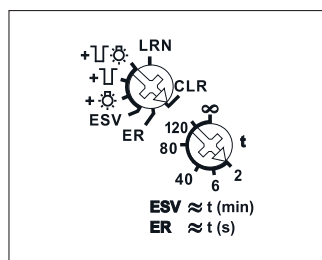

Standard setting ex works.

Typical connection

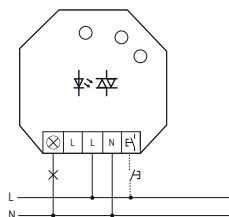

Manuals and documents in further languages:
<http://eltako.com/redirect/FSR61G-230V>

For installation. 45 mm long, 45 mm wide, 33 mm deep.

Supply voltage, switching voltage and control voltage local 230 V.

With automatic electronic over temperature shutdown.

At a load of < 1W a GLE has to be switched parallelly to the load.

In addition to the wireless control input via an internal antenna, this wireless actuator can also be controlled locally by a conventional 230 V control pushbutton mounted upstream.

Glow lamp current is not approved.

You can teach in encrypted sensors.

You can switch on **bidirectional wireless** and/or a **repeater** function.

Every change in state and incoming central command telegrams are then confirmed by a wireless telegram. This wireless telegram can be taught-in in other actuators like the FSR61NP-230V, controllers and in universal displays.

Scene control: several FSR61s can be switched on or off in a scene by one of the four control signals of a double-rocker pushbutton taught-in as scene pushbutton.

With the top rotary switch in the setting LRN up to 35 wireless pushbuttons can be assigned therefrom one or more central control pushbuttons. In addition wireless window/door contacts with the function N/O contact or N/C contact while the window is open, wireless outdoor brightness sensors FAH and wireless motion/brightness sensors FBH. The required function of the impulse switch with integrated relay function can then be selected:

ER = switching relay

ESV = impulse switch. Possibly with off delay, then:

+ =ESV with pushbutton permanent light

+ =ESV with switch-off early warning

+ =ESV with pushbutton permanent light and switch-off early warning

If the permanent light function is switched on, the function can be activated by pressing the pushbutton for longer than 1 second. This function switches off automatically after 2 hours or by pressing the pushbutton.

If the switch-off early warning is switched on, the light starts to flicker approx. 30 seconds before time-out. This is repeated three times at decreasing time intervals.

If both switch-off early warning and pushbutton permanent light are switched on, switch-off early warning is activated before automatic switch-off of the permanent light.

The function **ESV on the bottom rotary switch** sets the off delay from 2 to 120 minutes.

In setting ∞ normal impulse switch function ES without off delay, without pushbutton permanent light and without switch-off early warning.

In setting ER = switching relay of the other rotary switch, this 2nd rotary switch fulfils a safety and power saving function in the settings except ∞. If the switch-off command is not recognised, e.g. since the pushbutton is jammed or it was pressed too quickly, the relay switches off automatically on expiry of a time adjustable between 2 and 120 seconds. When a FTK is taught-in, this time function is turned off.

For **twilight switch** with taught-in wireless outdoor brightness sensor FAH and **motion detection** with taught-in wireless motion detector FBH see the operating instructions.

The LED performs during the teach-in process according to the operating instructions. It shows wireless control commands by short flickering during operation.

Technical data page T-3.

FSR61G-230V	Wireless actuator Impulse switch with integrated relay function	Art. No. 30100029	93,80 €/pc.
--------------------	--	--------------------------	--------------------

WIRELESS ACTUATOR IMPULSE SWITCH WITH INTEGRATED RELAY FUNCTION FSR61LN-230V FOR BIPOLAR SWITCHING OF L AND N

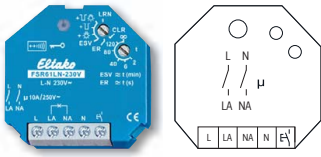

Function rotary switches

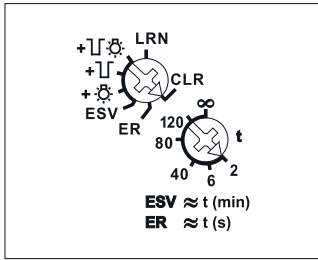

Standard setting ex works.

Typical connection

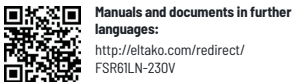
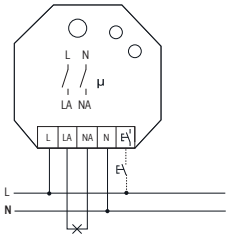

Technical data page T-3.

FSR61LN-230V



2 NO contacts for bipolar switching of L and N 10 A/250 V AC, 230 V LED lamps up to 400 W, incandescent lamps up to 2000 watts, off delay with switch-off early warning and switchable pushbutton permanent light. Encrypted wireless, bidirectional wireless and repeater function are switchable. Only 0.8 watt standby loss.

For installation. 45 mm long, 45 mm wide, 33 mm deep.

Supply voltage, switching voltage and control voltage local 230 V.

If a power failure occurs, the switching state is retained. If a power failure occurs repeatedly, the device is switched off in a defined sequence.

After installation, wait for short automatic synchronisation before the switched consumer is connected to the mains.

In addition to the wireless control input via an internal antenna, this universal impulse switching relay can also be controlled locally by a conventional control switch if fitted previously. Glow lamp current is not permitted.

You can teach in encrypted sensors.

You can switch on **bidirectional wireless** and/or a **repeater** function.

Every change in state and incoming central command telegrams are then confirmed by a wireless telegram. This wireless telegram can be taught-in in other actuators like the FSR61NP-230V, controllers and in universal displays.

Scene control: several FSR61LNs can be switched on or off in a scene by one of the four control signals of a double-rocker pushbutton taught-in as scene pushbutton.

With the top rotary switch in the setting LRN up to 35 wireless pushbuttons can be assigned, of which one or more central control pushbuttons. In addition wireless window/door contacts with the function N/O contact or N/C contact while the window is open. The required function of the impulse switch with integrated relay function can then be selected:

ER = switching relay

ESV = impulse switch. Possibly with off delay, then:

+  = ESV with pushbutton permanent light

+  = ESV with switch-off early warning

+  = ESV with pushbutton permanent light and switch-off early warning

If the permanent light function  is switched on, the function can be activated by pressing the pushbutton for longer than 1 second. This function switches off automatically after 2 hours or by pressing the pushbutton.

If the switch-off early warning  is switched on, the light starts to flicker approx. 30 seconds before time-out. This is repeated three times at decreasing time intervals.

If both switch-off early warning and pushbutton permanent light  are switched on, switch-off early warning is activated before automatic switch-off of the permanent light.

The function **ESV on the bottom rotary switch** sets the off delay from 2 to 120 minutes. In setting ∞ normal impulse switch function ES without off delay, without pushbutton permanent light and without switch-off early warning.

In setting ER = switching relay of the other rotary switch, this 2nd rotary switch fulfils a safety and power saving function in the settings except ∞ . If the switch-off command is not recognised, e.g. since the pushbutton is jammed or it was pressed too quickly, the relay switches off automatically on expiry of a time adjustable between 2 and 120 seconds. When a FTK is taught-in, this time function is turned off.

For **twilight switch** with taught-in wireless outdoor brightness sensor FAH and **motion detection** with taught-in wireless motion detector FBH see the operating instructions.

The LED performs during the teach-in process according to the operating instructions. It shows wireless control commands by short flickering during operation.

FSR61LN-230V	Wireless actuator Impulse switch with integr. relay function	Art. No. 30200331	92,30 €/pc.
---------------------	---	--------------------------	--------------------

WIRELESS ACTUATOR MULTIFUNCTION IMPULSE SWITCH FMS61NP-230V

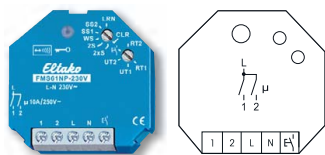

FMS61NP-230V



1+1 NO contacts not potential free 10 A/250 V AC, 230 V LED lamps up to 400 W, incandescent lamps up to 2000 watts. Encrypted wireless, bidirectional wireless and repeater function are switchable. Only 0.8 watt standby loss.

For installation. 45 mm long, 45 mm wide, 33 mm deep.

Supply voltage, switching voltage and control voltage local 230 V.

If a power failure occurs, the switching state is retained. If a power failure occurs repeatedly, the device is switched off in a defined sequence.

This wireless actuator is a multifunction impulse switch and features state-of-the-art hybrid technology that we developed: we combined the wear-free receiver and evaluation electronics and two bistable relays with zero passage switching.

By using a bistable relay coil power loss and heating is avoided even in the on mode. After installation, wait for short automatic synchronisation before the switched consumer is connected to the mains.

In addition to the wireless control input via an internal antenna, this multifunction impulse switch can also be controlled locally by a conventional 230 V control switch previously mounted (in the 2xS function only contact 1).

Maximum current as the sum of both contacts 16 A at 230 V.

You can teach in encrypted sensors. You can switch on **bidirectional wireless** and/or a **repeater** function.

Every change in state and incoming central command telegrams are confirmed by a wireless telegram.

This wireless telegram can be taught-in in other actuators, controllers and in universal displays.

With the top rotary switch in the setting LRN up to 35 wireless pushbuttons can be assigned, of which one or more central control pushbuttons. The required function of this multifunction impulse switch can then be selected. Switching will be visualised by flashing of the LED.

2xS = 2fold impulse switch each with 1 NO contact

2S = impulse switch with 2 NO contacts

WS = impulse switch with 1 NO contact and 1 NC contact

SS1 = impulse multicircuit switch 1 + 1 NO contact with switching sequence 1

SS2 = impulse multicircuit switch 1 + 1 NO contact with switching sequence 2

Switching sequence SS1: 0 - contact 1 - contact 2 - contacts 1+2

Switching sequence SS2: 0 - contact 1 - contacts 1+2 - contact 2

The bottom rotary switch is only required to teach-in the transmitters.

From production week 08/2013 universal pushbuttons and direction pushbuttons can be taught in.

The LED performs during the teach-in process according to the operating instructions. It shows wireless control commands by short flickering during operation.

3-18

Function rotary switches

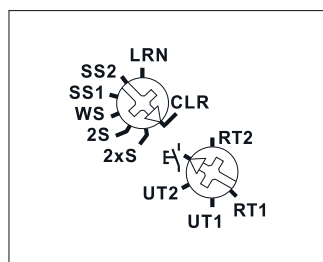

Standard setting ex works.

Typical connection

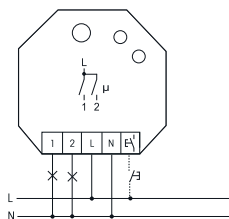

Manuals and documents in further languages:
<http://eltako.com/redirect/FMS61NP-230V>

Technical data page T-3.

FMS61NP-230V	Wireless actuator multifunction impulse switch, 1+1 NO contacts 10 A	Art. No. 30200330	94,60 €/pc.
---------------------	--	--------------------------	--------------------

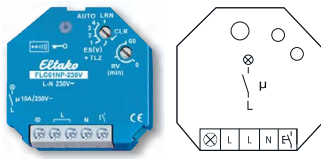

FLC61NP-230V



1 NO contact not potential free 10 A/250 V AC, 230 V LED lamps up to 400 W, incandescent lamps 2000 watts, 5 selectable operating modes. Encrypted wireless, bidirectional wireless and repeater function are switchable. Only 0.8 watt standby loss.

Function rotary switches

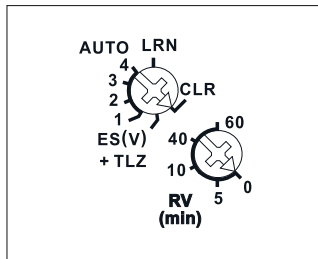

Standard setting ex works

Typical connection

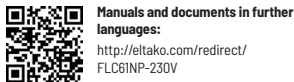
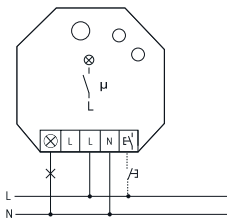

Manuals and documents in further languages:
<http://eltako.com/redirect/FLC61NP-230V>

For installation. 45 mm long, 45 mm wide, 33 mm deep.

Supply voltage, switching voltage and control voltage local 230 V.

If a power failure occurs, the switching state is retained. If a power failure occurs repeatedly, the device is switched off in a defined sequence.

After installation, wait for short automatic synchronisation before the switched consumer is connected to the mains.

In addition to the wireless control input via an internal antenna, this wireless actuator can also be controlled locally by a conventional 230V control pushbutton mounted upstream. Glow lamp current is not approved. You can teach in an operating mode pushbutton.

You can teach in encrypted sensors. You can switch on **bidirectional wireless** and/or a **repeater** function. Every change in state and incoming central command telegrams are then confirmed by a wireless telegram. This wireless telegram can be taught-in in other actuators, controllers and in universal displays.

With the top rotary switch in the setting LRN up to 35 wireless pushbuttons can be assigned therefrom one or more central control pushbuttons. In addition, wireless motion and brightness sensors. Then select **the required operating mode:**

ES(V)+TLZ: In this mode, the normal impulse switch function with buttons is active. Use the lower rotary switch RV to set a time delay between 0 and 60 minutes for the ESV function. Press the universal push-buttons and direction pushbuttons to switch on and off. The staircase time switch function TLZ results from the Central ON pushbuttons and a time delay set using the rotary switch RV.

AUTO1: In AUTO1 mode, (semi automatic motion: only switch off motion controlled), switch on/off takes place by means of universal pushbuttons, direction pushbuttons or central control pushbuttons. Switch-off takes place by means of one or several wireless motion sensors in case of no motion on expiry of the time delay set between 0 and 60 minutes using the lower rotary switch RV.

AUTO2: In AUTO2 mode (semi automatic motion and brightness: only switch off, motion and brightness controlled), switch on/off takes place by means of the universal pushbuttons, direction pushbuttons or central control pushbuttons. Switch-off takes place by means of one or several wireless motion/brightness sensors in case of no motion or insufficient brightness on expiry of the time delay set between 0 and 60 minutes using the lower rotary switch RV.

AUTO3: In AUTO3 mode, (fully automatic motion: switch on and off, motion controlled), switch-on takes place in case of brightness threshold undershoot by means of one or several wireless motion/brightness sensors and switch-off takes place in case of no motion on expiry of time delay set between 0 and 60 minutes using lower rotary switch RV. In addition, switch on/off takes place by means of universal push-buttons, direction pushbuttons or central control pushbuttons.

AUTO4: In AUTO4 mode (fully automatic motion and brightness: switch on and off, motion and brightness controlled), switch-on takes place in case of brightness threshold undershoot by means of one or several wireless motion/brightness sensors and switch-off takes place in case of no motion or sufficient brightness on expiry of time delay set between 0 and 60 minutes using lower rotary switch RV. In addition, switch on/off takes place by means of universal pushbuttons, direction pushbuttons or central control pushbuttons.

Once you have taught in an **operating mode pushbutton**, the 4 switches are configured with the following functions: top left **AUTO**, function according to the rotary switch position. Top right **ON** with priority. Bottom left and right **OFF** with priority. When you select **AUTO** mode, the lamp lights up briefly and then goes out.

One FBH in the room is sufficient to measure brightness when the lighting comprises LED lamps, energy saving lamps or fluorescent lamps. If lighting consists of electric light bulbs or halogen lamps, an outdoor brightness sensor must be taught-in as Master for operating modes AUTO2 and AUTO4. If several sensors are taught-in, switch-off only takes place when all sensors report no motion or sufficient brightness.

The LED performs during the teach-in process according to the operating instructions. It shows wireless control commands by short flickering during operation.

FLC61NP-230V	Wireless actuator - Light controller	Art. No. 30100040	94,30 €/pc.
--------------	--------------------------------------	-------------------	-------------

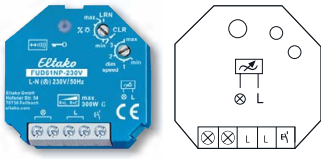

FUD61NP-230V



Without N connection, power MOSFET up to 300 W. Only 0.7 watt standby loss. With adjustable minimum brightness and dimming speed. With switching operation for children's rooms and snooze function. Light scenes can be taught-in. Encrypted wireless, bidirectional wireless and repeater function are switchable.

For installation. 45 mm long, 45 mm wide, 33 mm deep.
 Universal dimmer switch for R, L and C loads up to 300 watts, depending on ventilation conditions. Automatic detection of load R+L or R+C.

Without N connection, therefore it is suitable for mounting directly behind the pushbutton light switch, even if there is no N wire.

Not compatible with 230 V LED and energy saving lamps, please use this dimmer with N connection: FUD61NPN.

Supply voltage, switching voltage and control voltage local 230 V. Minimum load only 40 W.

Zero passage switching with soft ON and soft OFF to protect lamps.

The brightness level is stored on switch-off (memory).

In case of a power failure the switch position is stored and may be switched on when the power supply is restored.

Automatic electronic overload protection and overtemperature switch-off.

The minimum brightness (fully dimmed) is adjustable **with the % rotary switch.**

In the setting LRN up to 35 wireless pushbuttons can be assigned, of which one or more central push-buttons.

The dimming speed is adjustable using the **dimming speed rotary switch.** At the same time, the soft ON and soft OFF periods are changed.

In addition to the wireless control input via an internal antenna, this universal dimmer switch can also be controlled locally by a conventional 230 V control switch if fitted previously.

You can teach in encrypted sensors.

You can switch on **bidirectional wireless** and/or a **repeater** function.

Every change in state and incoming central command telegrams are then confirmed by a wireless telegram. This wireless telegram can be taught-in in other actuators like the FSR61NP-230V, controllers and in universal displays. The current dimming value is also displayed in % in the respective app.

The wireless pushbuttons can be taught-in either as direction pushbuttons or universal pushbuttons:

When installed as a direction pushbutton, one side is then 'switch on and dim up' and the other side is 'switch off and dim down'. A double-click on the switch-on side activates automatic dim-up to full brightness at dim speed. A double click on the switch-off side activates the snooze function. The children's room function is implemented on the switch-on side.

As a universal pushbutton, change the direction by briefly releasing the pushbutton.

Short control commands switch on/off.

For light scene control, children's room circuit and sleep timer, refer to the operating instructions.

The LED performs during the teach-in process according to the operating instructions. It shows wireless control commands by short flickering during operation.

3-20

Function rotary switches

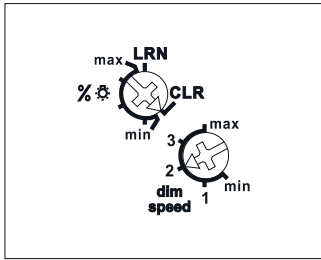

Standard setting ex works.

Typical connection

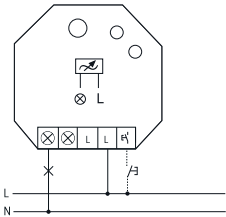

Manuals and documents in further languages:
<http://eltako.com/redirect/FUD61NP-230V>

Technical data page T-3.

FUD61NP-230V	Wireless actuator Universal dimmer switch without N	Art. No. 30100830	105,10 €/pc.
---------------------	--	--------------------------	---------------------

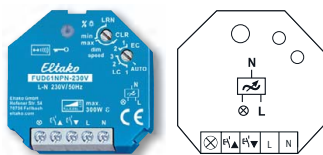

FUD61NPN-230V



Universal dimmer switch, 300 W power MOSFET. Automatic lamp detection. Only 0.7 watt standby loss. With adjustable minimum brightness or dimming speed. With switching operation for light alarm clocks, children's rooms and snooze function. Additionally with light scene control. Encrypted wireless, bidirectional wireless and repeater function are switchable.

3-21

Function rotary switches

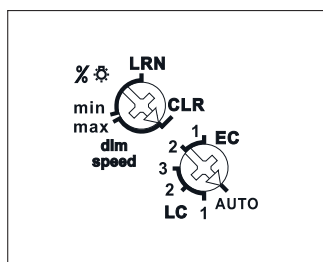

Standard setting ex works.

Typical connections

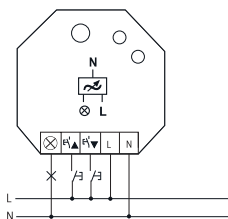

with direction pushbutton

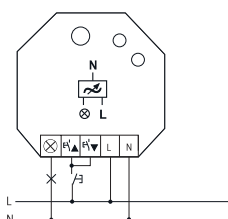

with universal pushbutton



Manuals and documents in further languages:
<http://eltako.com/redirect/FUD61NPN-230V>

Technical data page T-3.

For installation. 45 mm long, 45 mm wide, 33 mm deep.

Universal dimmer switch for lamps up to 300 W, dependent on ventilation conditions. Dimmable 230 V-LED lamps and dimmable energy saving lamps ESL, additionally dependent on the lamps electronics and the dimming technology, **see technical data page T-3.**

Zero passage switching with soft ON and soft OFF to protect lamps.

Supply voltage, switching voltage and control voltage local 230 V. No minimum load.

The brightness level is stored on switch-off (memory).

In case of a power failure the switch position and the brightness stage are stored and may be switched on when the power supply is restored.

Automatic electronic overload protection and overtemperature switch-off.

You can teach in encrypted sensors.

You can switch on **bidirectional wireless** and/or a **repeater** function.

Every change in state and incoming central command telegrams are then confirmed by a wireless telegram. This wireless telegram can be taught into other actuators like the FSR61NP-230V, universal displays and controller. The current dimming value is also displayed in % in the respective app.

The minimum brightness (fully dimmed) or the dimming speed is adjustable **with the upper %/dimming speed rotary switch.**

The lower rotary switch determines the operation, whether the automatic lamp detection or special comfort positions should act:

AUTO allows the dimming of all light species.

LC1 is a comfort position for dimmable 230 V LED lamps which are not being dimmed down enough when set to AUTO (trailing phase angle) dependent on the construction and must therefore be forced to leading phase angle.

LC2 and **LC3** are comfort positions for dimmable 230 V LED lamps like LC1, but with different dimming curves.

EC1 is a comfort position for energy saving lamps which must be switched on with increased power dependent on the construction, so they will also switch on again safely in cold condition when dimmed down.

EC2 is a comfort position for energy saving lamps which will not be switched on again when dimmed down dependent on the construction. Memory is switched off in this position.

In positions LC1, LC2, LC3, EC1 and EC2 no inductive (wound) transformers should be used. In addition, the maximum number of dimmable LED lamps can be lower than in the AUTO position dependent on the construction.

The pushbuttons can be either taught-in as direction pushbuttons or universal pushbuttons:

As direction pushbutton 'switch on and dim up' is on one side and 'switch off and dim down' on the other side. A double-click on the switch on side triggers the automatic dimming up to full brightness with dim speed time. A double-click on the switch off side triggers the snooze function. The children's room function is triggered on the switch on side. **As a universal pushbutton** the direction change is made by briefly releasing the pushbutton.

For light scene control, light alarm circuit, children's room circuit and sleep timer, refer to the operator manual.

The LED performs during the teach-in process according to the operating instructions. It shows wireless control commands by short flickering during operation.

FUD61NPN-230V	Wireless actuator Universal dimmer switch	Art. No. 30100835	109,20 €/pc.
----------------------	--	--------------------------	---------------------

WIRELESS ACTUATOR CONSTANT CURRENT LED DIMMER SWITCH FKLD61

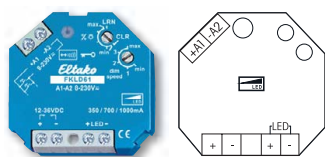

FKLD61



DC constant current source for LEDs up to 1000 mA or 30 watts. Only 0.3 watt standby loss. With adjustable minimum brightness and dimming speed. With switching operation for children's rooms and snooze function. Also with light scene control by PC or wireless pushbuttons. Encrypted wireless and repeater function are switchable.

For installation. 45 mm long, 45 mm wide, 33 mm deep.

The nominal output current can be set with a jumper on the circuit board:

no connection: 350 mA; flush right (Pin 2-3 connected): 700 mA; flush left (Pin 1-2 connected): 1000 mA.

Factory settings 700 mA. The input voltage ranges from 12 V DC to 36 V DC maximum. The input voltage must be selected to the sum of the LED at the output voltage, so that the current control can operate.

This deviation must be at least 6 volts. The total power output current x output voltage should not exceed 30 watts.

A pulse resistant DC power supply unit is required, which provides the necessary voltage and required current of the LED light(s).

Universal control voltage input 8 to 230 V UC, electrically isolated from the 230 V supply voltage and switching voltage.

The brightness level is stored on switch-off (memory).

In case of a power failure the switch position and the brightness stage are stored and may be switched on when the power supply is restored.

Automatic electronic overload protection and overtemperature switch-off.

You can teach in encrypted sensors.

You can switch on **bidirectional wireless** and/or a **repeater** function.

The minimum brightness (fully dimmed) is adjustable **with the upper % rotary switch**.

In the setting LRN up to 35 pushbuttons can be assigned, of which one or more central pushbuttons.

The dimming speed can be adjusted **with the lower dimming speed rotary switch**.

In addition to the wireless control input via an internal antenna, this universal dimmer switch can also be controlled locally by a conventional 230 V control switch if fitted previously. A short interruption of control changes the direction of dimming. Short control commands switch on/off.

The pushbuttons can be either taught-in as direction pushbuttons or universal pushbuttons: As direction pushbutton 'switch on and dim up' is on one side and 'switch off and dim down' on the other side. A double-click on the switch on side triggers the automatic dimming up to full brightness with dim speed time. A double-click on the switch off side triggers the snooze function. The children's room function is triggered on the switch on side. **As a universal pushbutton** the direction change is made by briefly releasing the pushbutton. With switching operation for children's rooms and snooze function.

Central pushbutton 'on' switches on with memory value. **Central pushbutton 'off'** switches off. **Switching operation for children's rooms** (universal pushbutton or direction pushbutton on the switch-on side): If the light is switched on by holding down the pushbutton, it starts at the lowest brightness level after approx. 1 second and dims up slowly as long as the pushbutton is held down without modifying the last stored brightness level.

Snooze function (universal pushbutton or direction pushbutton on the switch-off side): With a double impulse the lighting is dimmed down from the current dimming position to the minimum brightness level and switched off. The current dimming position as well as the adjustable minimum brightness level determine the dimming time (max. = 60 minutes) which can be reduced as required. It can be switched off at any time by short-time control commands during the lighting is dimmed down.

Light scenes via app are set and retrieved using the controller.

Lights scenes with wireless pushbuttons are taught in on the FKLD61 device. Up to four brightness values which can be taught-in in light scene pushbuttons with double rocker.

A **FBH** can either be taught-in as a movement detector with/without twilight switch or a **FAH** as a twilight switch according to the operating instructions.

The LED performs during the teach-in process according to the operating instructions. It shows wireless control commands by short flickering during operation.

Function rotary switches

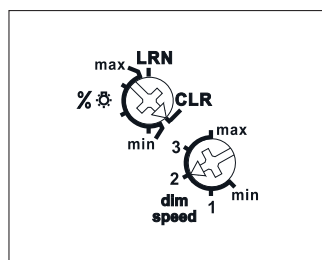

Standard setting ex works.

Typical connection

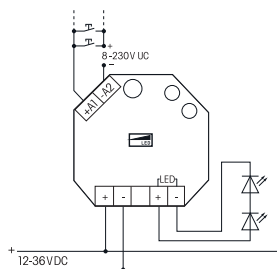

Manuals and documents in further languages:
<http://eltako.com/redirect/FKLD61>

Technical data page T-3.

FKLD61	Wireless actuator Constant current LED dimmer switch	Art. No. 30100836	106,10 €/pc.
---------------	---	--------------------------	---------------------

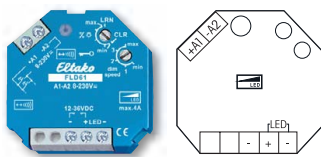

Function rotary switches

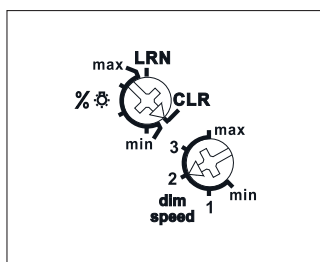

Standard setting ex works.

Typical connection

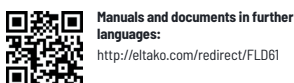
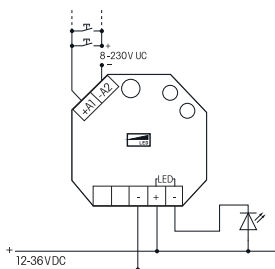

Manuals and documents in further languages:
<http://eltako.com/redirect/FLD61>

FLD61



PWM LED dimmer switch for LEDs 12-36 V DC, up to 4 A. Only 0.2-0.4 watt standby loss. With adjustable minimum brightness and dimming speed. With switching operation for children's rooms and snooze function. Also with light scene control by PC or wireless pushbuttons. Encrypted wireless, bidirectional wireless and repeater function are switchable.

For installation. 45 mm long, 45 mm wide, 33 mm deep.
 Supply voltage 12 to 36 V DC, depending on the connected LED lighting.
 Output voltage PWM (puls width modulation).
 Maximum output voltage 4 A.
 A pulse resistant DC power supply unit is required, which provides the necessary voltage and required current of the LED light(s).
Universal control voltage input 8 to 230 V UC, electrically isolated from the 230 V supply voltage and switching voltage.

The brightness level is stored on switch-off (memory).
 In case of a power failure the switch position and the brightness stage are stored and may be switched on when the power supply is restored.

Automatic electronic overload protection and overtemperature switch-off.
You can teach in encrypted sensors. You can switch on **bidirectional wireless** and/or a **repeater** function. The minimum brightness (fully dimmed) is adjustable **with the upper % rotary switch**. In the setting LRN up to 35 pushbuttons can be assigned, of which one or more central pushbuttons.
 The dimming speed can be adjusted **with the lower dimming speed rotary switch**.

In addition to the wireless control input via an internal antenna, this universal dimmer switch can also be controlled locally by a conventional 230 V control switch if fitted previously. A short interruption of control changes the direction of dimming. Short control commands switch on/off.

The pushbuttons can be either taught-in as direction pushbuttons or universal pushbuttons: As direction pushbutton 'switch on and dim up' is on one side and 'switch off and dim down' on the other side. A double-click on the switch on side triggers the automatic dimming up to full brightness with dim speed time. A double-click on the switch off side triggers the snooze function. The children's room function is triggered on the switch on side. **As a universal pushbutton** the direction change is made by briefly releasing the pushbutton.

Central pushbutton 'on' switches on with memory value. **Central pushbutton 'off'** switches off.
Switching operation for children's rooms (universal pushbutton or direction pushbutton on the switch-on side): If the light is switched on by holding down the pushbutton, it starts at the lowest brightness level after approx. 1 second and dims up slowly as long as the pushbutton is held down without modifying the last stored brightness level.

Snooze function (universal pushbutton or direction pushbutton on the switch-off side): With a double impulse the lighting is dimmed down from the current dimming position to the minimum brightness level and switched off. The current dimming position as well as the adjustable minimum brightness level determine the dimming time (max. = 60 minutes) which can be reduced as required. It can be switched off at any time by short-time control commands during the lighting is dimmed down.

Light scenes via app are set and retrieved using the controller.
Lights scenes with wireless pushbuttons are taught in on the FLD61 device. Up to four brightness values which can be taught-in in light scene pushbuttons with double rocker.

A **FBH** can either be taught-in as a movement detector with/without twilight switch or a **FAH** as a twilight switch according to the operating instructions.

The LED performs during the teach-in process according to the operating instructions. It shows wireless control commands by short flickering during operation.

Technical data page T-3.

FLD61	Wireless actuator PWM LED dimmer switch, 12-36 V DC up to 4 A	Art. No. 30100837	100,10 €/pc.
--------------	---	--------------------------	---------------------

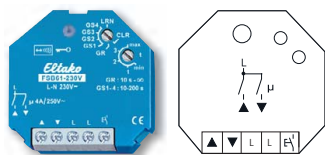

3-24

Function rotary switches

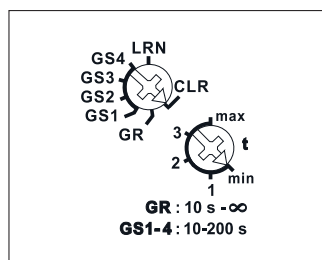

Standard setting ex works.

Typical connection

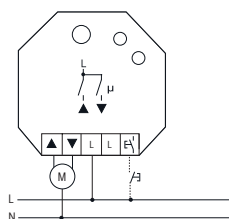

Manuals and documents in further languages:
<http://eltako.com/redirect/FSB61-230V>

FSB61-230V



Without N connection, 1+1 NO contact not potential free 4 A/250 V AC, for roller blinds and shading systems. Encrypted wireless, bidirectional wireless and repeater function are switchable. Only 0.8 watt standby loss.

For installation. 45 mm long, 45 mm wide, 33 mm deep.
 Supply voltage, switching voltage and control voltage local 230 V.
 Without N connection, not suitable for all motors.

If a power failure occurs, the device is switched off in a defined sequence.
 In addition to the wireless control input via an internal antenna, this wireless actuator can also be controlled locally by a conventional 230 V control switch previously mounted.

You can teach in encrypted sensors. You can switch on **bidirectional wireless** and/or a **repeater** function. Every change in state and incoming central command telegrams are then confirmed by a wireless telegram. This wireless telegram can be taught-in in other actuators, controllers and in universal displays.

With the top rotary switch in the setting LRN up to 35 wireless pushbuttons can be assigned, of which one or more central pushbuttons. The required function of this impulse group switch can then be selected:

GS1 = Group switch with pushbutton control and off delay in seconds. Both a wireless pushbutton with the function 'Up-Hold-Down-Hold' as well as the local pushbutton can be taught-in or a wireless pushbutton like a roller Venetian blind double pushbutton with pressing above 'Up' and pressing below 'Down'. Tap briefly to interrupt the movement immediately. However, a pulse in the opposite direction stops and then switches over to the opposite direction after a pause of 500 ms.

Dynamic central control with and without priority can be implemented.

GS2 = Group switch same as GS1, central switch always without priority.
GS3 = Group switch same as GS2, **in addition with double-click reverse function** for the local pushbutton and a wireless pushbutton as universal switch taught-in appropriately: After double-clicking, the Venetian blind moves in the opposite direction until it is stopped by a brief tap.

GS4 = Group switch same as GS2, **in addition with tip reverse function:** The control pushbutton is initially in static mode. The relay is energised as long as the pushbutton is tapped so that the Venetian blind can be reversed in the opposite direction by short impulses.

GR = Group relay. As long as the wireless pushbutton is closed, a contact is closed. Then it reopens. On reception of the next wireless signal the other contact closes, etc.

Shading scene control: Up to 4 saved 'Down' running times are retrievable using the control signal of a pushbutton and double rocker taught-in as a scene pushbutton.

With control via controller, operating commands for up and down with the exact travel time information can be started. As the actuator reports the exact elapsed time after each activity, even when driving was triggered by a pushbutton, the position of the shading is always displayed correctly in the controller. Upon reaching the end positions above and below the position is automatically synchronized.

If a **wireless outdoor brightness sensor** is also taught-in in addition to a scene pushbutton, the taught-in scenes 1, 2 and 4 are executed automatically depending on the outdoor brightness.

Use the bottom rotary switch to set the time delay to the position 'Halt' in seconds. Select a delay time that is at least as long as the shading element or roller shutter needs to move from its end position to the other position.

When you teach in an FTK wireless window/door contact or a window handle sensor FFG7B, a lock out protection is set when doors are opened to prevent Central Down and Scene Down.

The LED performs during the teach-in process according to the operating instructions. It shows wireless control commands by short flickering during operation.

Technical data page T-3.

FSB61-230V	Wireless actuator without N-connection for shading elements and roller shutters	Art. No. 30200432	94,90 €/pc.
-------------------	---	--------------------------	--------------------

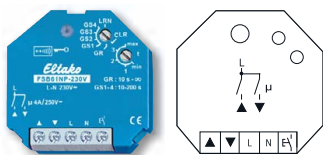

Function rotary switches

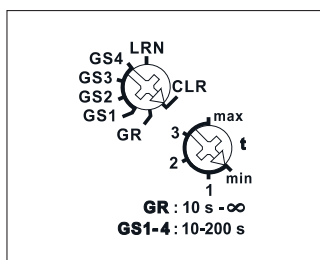

Standard setting ex works.

Typical connection UT

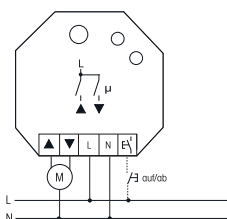

Typical connection RT

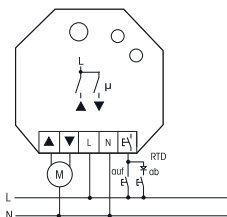

QR code and manual information: <http://eltako.com/redirect/FSB61NP-230V>

FSB61NP-230V

1+1 NO contact not potential free 4 A/250 V AC, for roller blinds and shading systems. Encrypted wireless, bidirectional wireless and repeater function are switchable. Only 0.9 watt standby loss.

For installation. 45 mm long, 45 mm wide, 33 mm deep.

Supply voltage, switching voltage and control voltage local 230 V.

If a power failure occurs, the device is switched off in a defined sequence.

In addition to the wireless control input via an internal antenna, this wireless actuator can also be controlled locally by a conventional 230 V control switch previously mounted.

From production week 36/19, a direction button for 'Down' can be connected via the diode RTD (any polarity). Another direction button for 'Up' is connected directly to the control input.

With the 1st control pulse 'down', the FSB61 switches the control input to 'direction button'. To switch the control input back to 'universal button', the supply voltage must be briefly switched off.

You can teach in encrypted sensors.

You can switch on **bidirectional wireless** and/or a **repeater** function.

Every change in state and incoming central command telegrams are then confirmed by a wireless telegram. This wireless telegram can be taught-in in other actuators, controllers and in universal displays.

With the top rotary switch in the setting LRN up to 35 wireless pushbuttons can be assigned, of which one or more central pushbuttons. The required function of this impulse group switch can then be selected:

- GS1** = Group switch with pushbutton control and off delay in seconds. Both a wireless pushbutton with the function 'Up-Hold-Down-Hold' can be taught-in or a wireless pushbutton like a roller Venetian blind double pushbutton with pressing above 'Up' and pressing below 'Down'. Tap briefly to interrupt the movement immediately. However, a pulse in the opposite direction stops and then switches over to the opposite direction after a pause of 500 ms.

Dynamic central control with and without priority can be implemented.

- GS2** = Group switch same as GS1, central switch always without priority.
- GS3** = Group switch same as GS2, **in addition with double-click reverse function** for the local pushbutton and a wireless pushbutton as universal switch taught-in appropriately: After double-clicking, the Venetian blind moves in the opposite direction until it is stopped by a brief tap.

- GS4** = Group switch same as GS2, **in addition with tip reverse function:** The control pushbutton is initially in static mode. The relay is energised as long as the pushbutton is tapped so that the Venetian blind can be reversed in the opposite direction by short impulses.

- GR** = Group relay. As long as the wireless pushbutton is closed, a contact is closed. Then it reopens. On reception of the next wireless signal the other contact closes, etc.

Shading scene control: Up to 4 saved 'Down' running times are retrievable using the control signal of a pushbutton and double rocker taught-in as a scene pushbutton.

With control via controller, operating commands for up and down with the exact travel time information can be started. As the actuator reports the exact elapsed time after each activity, even when driving was triggered by a pushbutton, the position of the shading is always displayed correctly in the controller. Upon reaching the end positions above and below the position is automatically synchronized.

If a **wireless outdoor brightness sensor** is also taught-in in addition to a scene pushbutton, the taught-in scenes 1, 2 and 4 are executed automatically depending on the outdoor brightness.

Use the bottom rotary switch to set the time delay to the position 'Halt' in seconds. Select a delay time that is at least as long as the shading element or roller shutter needs to move from its end position to the other position.

When you teach in an FTK wireless window/door contact or a window handle sensor FFG7B, a lock out protection is set when doors are opened to prevent Central Down and Scene Down.

The LED performs during the teach-in process according to the operating instructions. It shows wireless control commands by short flickering during operation.

FSB61NP-230V	Wireless actuator for shading elements and roller shutters	Art. No. 30200430	92,10 €/pc.
---------------------	--	--------------------------	--------------------

Technical data page T-3.

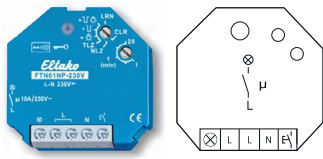

FTN61NP-230V



1 NO contact not potential free 10 A/250 V AC, 230 V LED lamps up to 400 W, incandescent lamps up to 2000 watts, off delay with switch-off early warning and switchable pushbutton permanent light. Encrypted wireless, bidirectional wireless and repeater function are switchable. Only 0.8 watt standby loss.

For installation. 45 mm long, 45 mm wide, 33 mm deep.
Supply voltage, switching voltage and control voltage local 230 V.
Zero passage switching to protect contacts and consumers.

This wireless actuator is a staircase off-delay timer and features state-of-the-art hybrid technology that we developed: we combined the wear-free receiver and evaluation electronics and a bistable relay with zero passage switching.

By using a bistable relay coil power loss and heating is avoided even in the on mode. After installation, wait for short automatic synchronisation before the switched consumer is connected to the mains. In addition to the wireless control input via an internal antenna, this staircase off-delay timer can also be controlled locally by a conventional 230 V control switch previously mounted.

Glow lamp current up to 5 mA, dependent on the ignition voltage of the glow lamps.

The lighting is switched on again after a power failure provided the set time has not yet elapsed.

You can teach in encrypted sensors. You can switch on **bidirectional wireless** and/or a **repeater** function. Every change in state and incoming central command telegrams are confirmed by a wireless telegram. This wireless telegram can be taught-in in other actuators, controllers and in universal displays.

With the top rotary switch in the setting LRN up to 35 wireless pushbuttons and/or wireless motion/brightness sensors FBH can be assigned, of which one or more central pushbuttons. The required function of this staircase off-delay timer can then be selected.

The flashing of the LED as soon as a new setting range has been reached when turning the rotary switch helps to find the desired position reliably.

NLZ = off-delay timer

TLZ = staircase time switch

+  = TLZ with pushbutton permanent light

+  = TLZ with switch-off early warning

+  = TLZ with pushbutton permanent light and switch-off early warning

If the permanent light function  is switched on, the function can be activated by pressing the pushbutton for longer than 1 second. This function switches off automatically after 60 minutes or by pressing the pushbutton for longer than 2 seconds.

If the switch-off early warning  is switched on, the light starts to flicker approx. 30 seconds before time-out. This is repeated three times at decreasing time intervals.

If both switch-off early warning and pushbutton permanent light  are switched on, switch-off early warning is activated before automatic switch-off of the permanent light.

With the bottom rotary switch, the off delay is adjusted from 1 to 20 minutes.

When **motion/brightness sensors FBH** are taught-in, use the last FBH that was taught-in to define the switching threshold at which the lighting is switched on or off depending on the brightness or motion detected. The off delay set on the FTN61NP is prolonged by a setting of 1 minute fixed in the FBH.

The LED performs during the teach-in process according to the operating instructions. It shows wireless control commands by short flickering during operation.

3-26

Function rotary switches

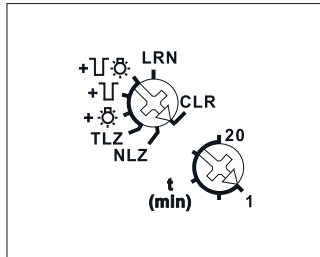

Standard setting ex works.

Typical connection

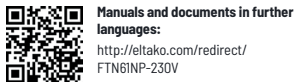
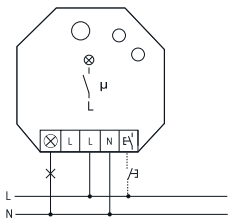

Manuals and documents in further languages:
<http://eltako.com/redirect/FTN61NP-230V>

Technical data page T-3.

FTN61NP-230V	Wireless actuator Staircase off-delay timer	Art. No. 30100130	92,70 €/pc.
--------------	---	-------------------	-------------

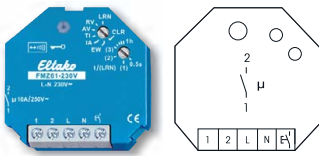

FMZ61-230V



1 NO contact potential free 10 A/250 V AC, 230 V LED lamps up to 400 W, incandescent lamps up to 2000 watts.* Encrypted wireless, bidirectional wireless and repeater function are switchable. Only 0.8 watt standby loss.

Function rotary switches

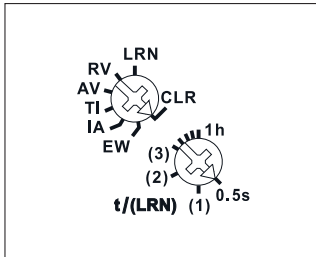

Standard setting ex works.

Typical connection

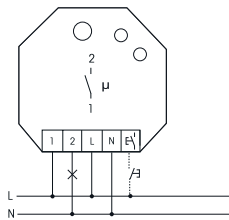

Manuals and documents in further languages:
<http://eltako.com/redirect/FMZ61-230V>

Technical data page T-3.

For installation. 45 mm long, 45 mm wide, 33 mm deep.

Supply voltage and if necessary control voltage locally 230 V.

If a power failure occurs, the switching state is retained. If a power failure occurs repeatedly, the device is switched off in a defined sequence.

This wireless actuator features state-of-the-art hybrid technology that we developed: we combined the wear-free receiver and evaluation electronics with a bistable relay.

By using a bistable relay coil power loss and heating is avoided even in the on mode.

After installation, wait for short automatic synchronisation before the switched consumer is connected to the mains.

In addition to the wireless control input via an internal antenna, this wireless actuator can also be controlled locally by a conventional control switch if fitted previously.

Glow lamp current is not permitted.

You can teach in encrypted sensors.

You can switch on **bidirectional wireless** and/or a **repeater** function.

Every change in state and incoming central command telegrams are confirmed by a wireless telegram.

This wireless telegram can be taught-in in other actuators, controllers and in universal displays.

With the top rotary switch in the setting LRN up to 35 wireless pushbuttons can be assigned, of which one or more central control pushbuttons. In addition, wireless window/door contacts (FTK) may have a NO or NC function when the window is open. If a direction pushbutton is taught-in, a function (e.g. TI) can be started using the top key (START) and stopped with the bottom key (STOP). The required function can then be selected. Switching will be visualised by flashing of the LED.

RV = off delay

AV = operating delay

TI = clock generator starting with impulse

IA = impulse-controlled operating delay

EW = fleeting NO contact

The bottom rotary switch sets the time from 0.5 seconds to 60 minutes.

The LED performs during the teach-in process according to the operating instructions. It shows wireless control commands by short flickering during operation.

* The maximum load can be used from a delay time or clock cycle of 5 minutes. The maximum load is reduced for shorter times as follows: up to 2 minutes 30%, up to 5 minutes 60%.

FMZ61-230V	Wireless actuator Multifunction time relay	Art. No. 30100230	89,10 €/pc.
-------------------	--	--------------------------	--------------------

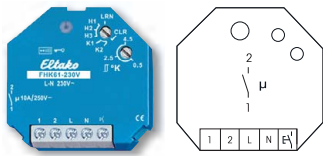

FHK61-230V



1 NO contact potential free 10 A/250 V AC. Only 0.8 watt standby loss.
Encrypted wireless, bidirectional wireless and repeater function are switchable.

For installation. 45 mm long, 45 mm wide, 33 mm deep.
 Supply voltage 230 V.

If a power failure occurs, the switching state is retained.

If a power failure occurs repeatedly, the device is switched off in a defined sequence.

After installation, wait for short automatic synchronisation before the switched consumer is connected to the mains.

This heating/cooling relay evaluates the information from wireless temperature controllers or sensors. Possibly supplemented by window/door contacts, motion detector, window handle sensor FFG7B and wireless pushbuttons.

Valves will be controlled with the potential-free contact.

You can teach in encrypted sensors.

You can switch on **bidirectional wireless** and/or a **repeater** function.

Each function change by a wireless temperature controller (normal mode, setback, off) is confirmed by a wireless telegram. This wireless telegram can be taught-in into controllers.

Upper rotary switch for operating modes:

H1: Heating operation with PWM control at T = 4 minutes (PWM = pulse width modulation).

(suitable for valves with thermoelectric valve drive)

H2: Heating operation with PWM control at T = 15 minutes.

(suitable for valves with motor-driven valve drive)

H3: Operating mode with 2-point control.

K1: Cooling operation with PWM control at T = 15 minutes.

K2: Cooling mode with 2-point control.

Switchover is visualised by LEDs flashing.

Lower rotary switch for adjustable hysteresis and PWM influence:

Left stop: lowest hysteresis 0.5°. **Middle position:** hysteresis 2.5°. **Right stop:** largest hysteresis 4.5°.

Inbetween, divisions in steps of 0.5° visualised by LEDs flashing.

Two-point control mode: The hysteresis rotary switch sets the required difference between the switch-on and switch-off temperatures.

When the 'actual temperature \geq reference temperature', the device is switched off.

When the 'actual temperature \leq (reference temperature - hysteresis)', the device is switched on.

The signs are the opposite in cooling mode.

PWM control mode: The hysteresis rotary switch set the required temperature difference at which the device is switched on at 100%. When the 'actual temperature \geq reference temperature', the device is switched off. When the 'actual temperature \leq (reference temperature - hysteresis)', the device is switched on at 100%. If the 'actual temperature' lies between the 'reference temperature - hysteresis' and the 'reference temperature', the device is switched on and off with a PWM in steps of 10% depending on the temperature difference. The lower the temperature difference, the shorter the switch-on time. As a result of the settable of the 100% value, the PWM can be adapted to the heater size and inertia. The signs are the opposite in cooling mode.

In heating mode, the **frost protection function** is always enabled. As soon as the actual temperature drops below 8°C, the temperature is controlled in the selected operating mode to 8°C.

If one or several windows are open, the output remains off **provided the window/door contacts FTK or window handle sensors FFG7B** are taught-in. In heating mode, however, the frost protection remains enabled.

As long as all taught-in **motion detectors FBH** detect no motion, the device is switched to setback mode. In heating mode, the reference temperature is set back by 2°; in cooling mode, it is raised by 2°. As soon as a motion detector signals movement again, the device is switched to normal mode.

When a **wireless pushbutton FT4** is taught-in, the assignment of the 4 keys is assigned with the following fixed functions:

Top right: Normal mode (can also be enabled by timer). Bottom right: Night setback mode by 4°; in cooling mode, raised by 4° (can also be enabled by timer). Top left: Setback mode by 2°, in cooling mode, raised by 2°. Bottom left: Off (in heating mode, frost protection enabled; in cooling mode permanent off). If the motion detector and wireless pushbutton are taught-in at the same time, the last telegram received is always the one that is valid. A motion detector therefore switches off a setback mode selected by wireless pushbutton when a movement is detected.

The LED performs during the teach-in process according to the operating instructions. It shows wireless control commands by short flickering during operation.

Function rotary switches

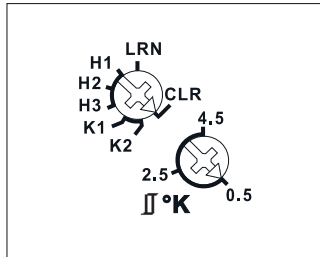

Standard setting ex works.

Typical connection

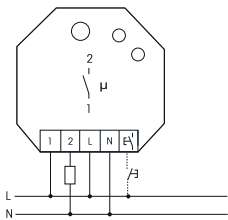

Manuals and documents in further languages:
<http://eltako.com/redirect/FHK61-230V>

FHK61-230V	Wireless actuator Heating/cooling relay	Art. No. 30100045	94,20 €/pc.
------------	---	-------------------	-------------

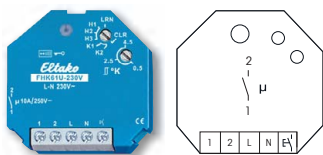

FHK61U-230V



1 NO contact potential free 10 A/250 V AC. Only 0.8 watt standby loss.
Encrypted wireless, bidirectional wireless and repeater function are switchable.

For installation. 45 mm long, 45 mm wide, 33 mm deep.
 Supply voltage 230 V.

If a power failure occurs, the switching state is retained. If a power failure occurs repeatedly, the device is switched off in a defined sequence.

By using a bistable relay coil power loss and heating is avoided even in the on mode. After installation, wait for short automatic synchronisation before the switched consumer is connected to the mains.

This heating/cooling relay evaluates the information from wireless temperature controllers or sensors. Possibly supplemented by window/door contacts, motion detector, window handle sensor FFG7B and wireless pushbuttons.

You can teach in encrypted sensors. You can switch on **bidirectional wireless** and/or a **repeater** function. Every change in state of the contact is confirmed by a wireless telegram.

This wireless telegram can be taught-in into other actuators and controllers. Especially into a FSR61 to synchronously switch a heat circulating pump with the valves.

Upper rotary switch for operating modes:

H1: Heating operation with PWM control at T = 4 minutes (PWM = pulse width modulation).

(suitable for valves with thermoelectric valve drive)

H2: Heating operation with PWM control at T = 15 minutes.

(suitable for valves with motor-driven valve drive)

H3: Operating mode with 2-point control.

K1: Cooling operation with PWM control at T = 15 minutes.

K2: Cooling mode with 2-point control.

Switchover is visualised by LEDs flashing.

Lower rotary switch for adjustable hysteresis and PWM influence:

Left stop: lowest hysteresis 0.5°. **Middle position:** hysteresis 2.5°. **Right stop:** largest hysteresis 4.5°.

Inbetween, divisions in steps of 0.5° visualised by LEDs flashing.

Two-point control mode: The hysteresis rotary switch sets the required difference between the switch-on and switch-off temperatures.

When the 'actual temperature \geq reference temperature', the device is switched off.

When the 'actual temperature \leq (reference temperature - hysteresis)', the device is switched on.

The signs are the opposite in cooling mode.

PWM control mode: The hysteresis rotary switch set the required temperature difference at which the device is switched on at 100%. When the 'actual temperature \geq reference temperature', the device is switched off. When the 'actual temperature \leq (reference temperature - hysteresis)', the device is switched on at 100%. If the 'actual temperature' lies between the 'reference temperature - hysteresis' and the 'reference temperature', the device is switched on and off with a PWM in steps of 10% depending on the temperature difference. The lower the temperature difference, the shorter the switch-on time. As a result of the settability of the 100% value, the PWM can be adapted to the heater size and inertia. The signs are the opposite in cooling mode.

In heating mode, the **frost protection function** is always enabled. As soon as the actual temperature drops below 8°C, the temperature is controlled in the selected operating mode to 8°C.

If one or several windows are open, the output remains off **provided the window/door contacts FTK or window handle sensors FFG7B** are taught-in. In heating mode, however, the frost protection remains enabled.

As long as all taught-in **motion detectors FBH** detect no motion, the device is switched to setback mode. In heating mode, the reference temperature is set back by 2°; in cooling mode, it is raised by 2°. As soon as a motion detector signals movement again, the device is switched to normal mode.

When a **wireless pushbutton FT4** is taught-in, the assignment of the 4 keys is assigned with the following fixed functions:

Top right: Normal mode (can also be enabled by timer). Bottom right: Night setback mode by 4°; in cooling mode, raised by 4° (can also be enabled by timer). Top left: Setback mode by 2°, in cooling mode, raised by 2°. Bottom left: Off (in heating mode, frost protection enabled; in cooling mode permanent off). If the motion detector and wireless pushbutton are taught-in at the same time, the last telegram received is always the one that is valid. A motion detector therefore switches off a setback mode selected by wireless pushbutton when a movement is detected.

The LED performs during the teach-in process according to the operating instructions. It shows wireless control commands by short flickering during operation.

Function rotary switches

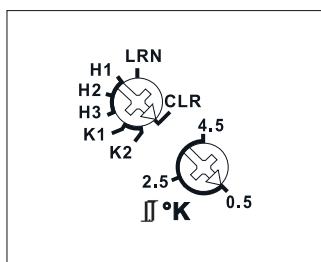

Standard setting ex works.

Typical connection

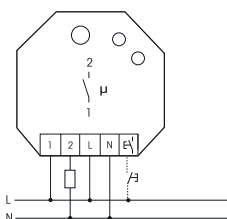

Manuals and documents in further languages:
<http://eltako.com/redirect/FHK61U-230V>

FHK61U-230V	Wireless actuator Heating/cooling relay	Art. No. 30100050	93,80 €/pc.
--------------------	---	--------------------------	--------------------

WIRELESS ACTUATOR HEATING/COOLING RELAY WITH SOLID STATE RELAY FHK61SSR-230V

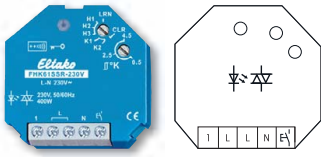

FHK61SSR-230V



Noiseless single room control, 400 W. Solid state relay not potential free. Only 0.8 watt standby loss. Encrypted wireless, bidirectional wireless and repeater function are switchable.

For installation. 45 mm long, 45 mm wide, 33 mm deep.
Supply voltage, switching voltage and control voltage local 230 V.
With a load < 1 W a GLE must be switched parallel to the load.

This heating/cooling relay evaluates the information from wireless temperature controllers or sensors. As required, supplemented by window/door contacts, motion detectors, window handle sensor FFG7B and wireless pushbuttons.

You can teach in encrypted sensors. You can switch on **bidirectional wireless** and/or a **repeater** function. Each function change (normal mode, decrease mode, off) is confirmed by a wireless telegram. This wireless telegram can be taught-in in controllers.

Upper rotary switch for operating modes:

H1: Heating operation with PWM control at T = 4 minutes. (suitable for valves with thermoelectric valve drive)

H2: Heating operation with PWM control at T = 15 minutes. (suitable for valves with motor-driven valve drive)

H3: Heating operation with 2-point control.

K1: Cooling operation with PWM control at T = 15 minutes.

K2: Cooling mode with 2-point control.

Switchover is visualised by LEDs flashing.

Lower rotary switch for adjustable hysteresis and PWM influence:

Left stop: lowest hysteresis 0.5°. **Middle position:** hysteresis 2.5°. **Right stop:** largest hysteresis 4.5°.

Inbetween, divisions in steps of 0.5° visualised by LEDs flashing.

Two-point control mode: The hysteresis rotary switch sets the required difference between the switch-on and switch-off temperatures. When the 'actual temperature >= reference temperature', the device is switched off. When the 'actual temperature <= (reference temperature - hysteresis)', the device is switched on. The signs are the opposite in cooling mode.

PWM control mode: The hysteresis rotary switch set the required temperature difference at which the device is switched on at 100%. When the 'actual temperature >= reference temperature', the device is switched off.

When the 'actual temperature <= (reference temperature - hysteresis)', the device is switched on at 100%. If the 'actual temperature' lies between the 'reference temperature - hysteresis' and the 'reference temperature', the device is switched on and off with a PWM in steps of 10% depending on the temperature difference.

The lower the temperature difference, the shorter the switch-on time. As a result of the settability of the 100% value, the PWM can be adapted to the heater size and inertia. The signs are the opposite in cooling mode. In heating mode, the **frost protection function** is always enabled. As soon as the actual temperature drops below 8°C, the temperature is controlled in the selected operating mode to 8°C.

If one or several windows are open, the output remains off **provided the window/door contacts FTK or window handle sensors FFG7B are taught-in**. In heating mode, however, the frost protection remains enabled.

As long as all taught-in **motion detectors FBH** detect no motion, the device is switched to setback mode. In heating mode, the reference temperature is set back by 2°; in cooling mode, it is raised by 2°. As soon as a motion detector signals movement again, the device is switched to normal mode.

When a **wireless pushbutton** is taught-in, the assignment of the 4 keys is assigned with the following fixed functions: Top right: Normal mode (can also be enabled by timer). Bottom right: Night setback mode by 4°; in cooling mode, raised by 4° (can also be enabled by timer). Top left: Setback mode by 2°, in cooling mode, raised by 2°. Bottom left: Off (in heating mode, frost protection enabled; in cooling mode permanent off). If the motion detector and wireless pushbutton are taught-in at the same time, the last telegram received is always the one that is valid. A motion detector therefore switches off a setback mode selected by wireless pushbutton when a movement is detected.

When bidirectional wireless is switched on, the FHK61 sends a confirmation telegram containing its own ID and current operating mode to the Eltako wireless network.

PWM setpoint function: When a PWM data telegram is taught-in, the control function selected at the rotary switch is switched off. Only PWM commands are executed. When bidirectional wireless is switched on, the FHK61 sends a received PWM data telegram as confirmation telegram containing its own ID to the Eltako wireless network.

The 230 V control input acts as a dew signalling input. When a voltage of 230 V is applied, the solid state relay is switched off. Every change in state of the control input is immediately sent as a button telegram cyclically every 15 minutes.

The LED performs during the teach-in process according to the operating instructions. It shows wireless control commands by short flickering during operation.

Function rotary switches

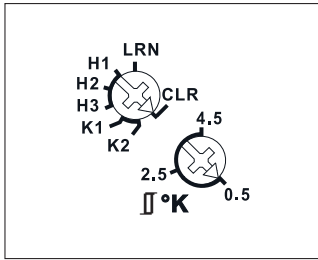

Standard setting ex works.

Typical connection

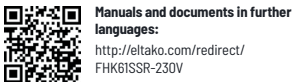
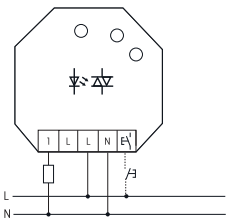

Manuals and documents in further languages:
<http://eltako.com/redirect/FHK61SSR-230V>

FHK61SSR-230V	Wireless actuator Heating/cooling relay	Art. No. 30100034	95,20 €/pc.
---------------	---	-------------------	-------------

ACCESSORIES

1- AND 2-LEVEL WIRELESS REPEATERS FRP61-230V

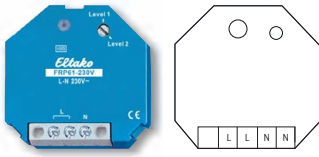

Manuals and documents in further languages:
<http://eltako.com/redirect/FRP61-230V>

FRP61-230V



1 and 2 level wireless repeaters. Only 0.7 watt standby loss.

For installation. 45 mm long, 45 mm wide, 33 mm deep.

Supply voltage 230 V.

This repeater is only needed if the building conditions prevent undisturbed reception or the distance between the wireless pushbutton and receiver is too great.

The 1-level mode is activated ex works. Only wireless signals from sensors are received, tested and retransmitted at full transmit power. Wireless signals from other repeaters are ignored to reduce the data volume.

Use the rotary switch to switch over to 2 level mode. Then the wireless signals from sensors and from another 1 level repeater are processed. A signal may therefore be received and amplified twice.

The LED indicates incoming wireless signals by flashing briefly.

Wireless repeaters need not be taught-in. They receive and amplify signals from all wireless sensors within their reception area.

3-31

FRP61-230V	1- and 2-level wireless repeater	Art. No. 30000350	69,30 €/pc.
-------------------	----------------------------------	--------------------------	--------------------



Manuals and documents in further languages:
<http://elitako.com/redirect/BPS55>

BPS55



Blisterpack switching with wireless pushbutton F2T55E and wireless actuator impulse switch with integrated relay function FSR61-230V. Smart Home sensor and Smart Home actuator.

F2T55E: Wireless pushbutton pure white glossy for single mounting 80 x 80 x 15 mm or mounting into the E-Design55 switching system. Generates the power for wireless telegrams itself when the button is pressed, therefore there is no connecting wire and no standby loss.

Wireless pushbuttons with one rocker can transmit two evaluable signals: press rocker up and press rocker down.

The mounting plate can be screwed over a flush-mounting box with a screw spacing of 60 mm or screwed on a flat surface. The wireless pushbutton can be glued to the wall, on glass or on furniture using the enclosed adhesive foil.

FSR61-230V: Wireless actuator impulse switch with integrated relay function. 1 NO contact potential free 10 A/250 V AC, incandescent lamps up to 2000 watts, off delay with switch-off early warning and switchable pushbutton permanent light. Encrypted wireless, bidirectional wireless and repeater function are switchable. Only 0.8 watt standby loss.

For installation. 45 mm long, 45 mm wide, 33 mm deep.

Supply voltage and control voltage locally 230 V.

If a power failure occurs, the switching state is retained. If a power failure occurs repeatedly, the device is switched off in a defined sequence. After installation, wait for short automatic synchronisation before the switched consumer is connected to the mains.

In addition to the wireless control input via an internal antenna, this universal impulse switching relay can also be controlled locally by a conventional control switch if fitted previously. Glow lamp current is not permitted.

BPS55	Blisterpack switching	Art. No. 30000037	139,70 €/pc.
-------	-----------------------	-------------------	--------------



Manuals and documents in further languages:
<http://eltako.com/redirect/BPD55>

BPD55



Blisterpack dimming with wireless pushbutton F2T55E and universal dimmer switch FUD61NPN-230V. Smart Home sensor and Smart Home actuator.

F2T55E: Wireless pushbutton pure white glossy for single mounting 80 x 80 x 15 mm or mounting into the E-Design55 switching system. Generates the power for wireless telegrams itself when the button is pressed, therefore there is no connecting wire and no standby loss.

Wireless pushbuttons with one rocker can transmit two evaluable signals: press rocker up and press rocker down.

The mounting plate can be screwed over a flush-mounting box with a screw spacing of 60 mm or screwed on a flat surface. The wireless pushbutton can be glued to the wall, on glass or on furniture using the enclosed adhesive foil.

FUD61NPN-230V: Universal dimmer switch, 300 W power MOSFET. Automatic lamp detection. Only 0.7 watt standby loss. With adjustable minimum brightness or dimming speed. With switching operation for light alarm clocks, children's rooms and snooze function. Additionally with light scene control. Encrypted wireless, bidirectional wireless and repeater function are switchable.

For installation. 45 mm long, 45 mm wide, 33 mm deep.

Universal dimmer switch for lamps up to 300 W, dependent on ventilation conditions. Dimmable 230 V-LED lamps and dimmable energy saving lamps ESL, additionally dependent on the lamps electronics.

Zero passage switching with soft ON and soft OFF to protect lamps.

Supply voltage, switching voltage and control voltage local 230 V. No minimum load.

The brightness level is stored on switch-off (memory).

BPD55	Blisterpack dimming	Art. No. 30000036	169,10 €/pc.
--------------	---------------------	--------------------------	---------------------



Manuals and documents in further languages:
<http://eltako.com/redirect/BPB55>

BPB55



Blisterpack shading with wireless pushbutton F2T55E and wireless actuator for shading elements and roller shutters FSB61NP-230V. Smart Home sensor and Smart Home actuator.

F2T55E: Wireless pushbutton pure white glossy for single mounting 80 x 80 x 15 mm or mounting into the E-Design55. Generates the power for wireless telegrams itself when the button is pressed, therefore there is no connecting wire and no standby loss.

Wireless pushbuttons with one rocker can transmit two evaluable signals: press rocker up and press rocker down.

The mounting plate can be screwed over a flush-mounting box with a screw spacing of 60 mm or screwed on a flat surface. The wireless pushbutton can be glued to the wall, on glass or on furniture using the enclosed adhesive foil.

FSB61NP-230V: Wireless actuator for shading elements and roller shutters. 1+1 NO contact not potential free 4 A/250 V AC, for roller blinds and shading systems. Encrypted wireless, bidirectional wireless and repeater function are switchable.

Only 0.8 watt standby loss.

For installation. 45 mm long, 45 mm wide, 33 mm deep.

Supply voltage, switching voltage and control voltage local 230 V.

If a power failure occurs, the device is switched off in a defined sequence.

In addition to the wireless control input via an internal antenna, this wireless actuator can also be controlled locally by a conventional 230 V control switch previously mounted.

BPB55	Blisterpack shading	Art. No. 30000035	153,30 €/pc.
--------------	---------------------	--------------------------	---------------------

WIRELESS TRANSMITTER MODULE FSM61-UC AND WIRELESS 4-WAY UNIVERSAL TRANSMITTER MODULE F4USM61B

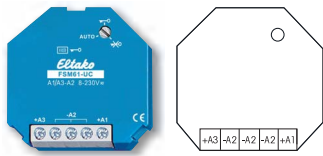

Typical connection

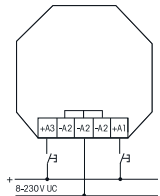

Manuals and documents in further languages:
<http://eltako.com/redirect/FSM61-UC>

Technical data page T-3.

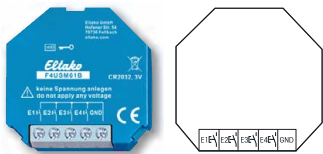

Typical connection

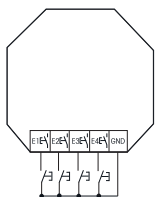

Caution!
Do not connect to a power supply.



Manuals and documents in further languages:
<http://eltako.com/redirect/F4USM61B>

FSM61-UC

Wireless 2-fold transmitter module. With internal antenna. No standby loss.

For installation. 45 mm long, 45 mm wide, 18 mm deep.

The wireless transmitter module FSM61-UC has two channels and can transmit wireless pushbutton telegrams to the Eltako building wireless system. A1 initiates a wireless telegram, such as 'Press top rocker' for a wireless pushbutton with one rocker and A3 such as 'Press bottom rocker'. The telegram on opening the two control contacts is identical to 'Release wireless pushbutton'.

Several wireless transmitter modules must not be switched at the same time.

The universal control voltage at +An/-A2 processes control commands of 8 to 253 V AC or 10 to 230 V DC with periods lasting min. 0.2 seconds. Max. parallel capacitance (approx. length) of control lead at 230 V 5 nF. This correspond to a length of approx. 20 meters.

If the terminals A1 and A3 are connected with a bridge, the wireless telegram is transmitted once per minute by A3, provided the control voltage is applied, e.g. for central commands with priority.

No permanent power supply required, therefore no standby losses.

The rotary switch is required for the activation or deactivation of encryption and is set to AUTO in operation.

Activate encryption:

Turn the rotary switch to the right stop (position key) and press once.

Deactivate encryption:

Turn the rotary switch to the left stop (position crossed out key) and press once.

FSM61-UC	Wireless 2-fold transmitter module	Art. No. 30000300	66,20 €/pc.
----------	------------------------------------	-------------------	-------------

F4USM61B

**Wireless 4-way universal transmitter module. With internal antenna.
With battery (lifetime 5-8 years).**

For installation. 45 mm long, 45 mm wide, 18 mm deep.

This transmitter module has four channels to transmit wireless telegrams to the Eltako Wireless Building system like a 4-channel wireless pushbutton. E1 initiates a wireless telegram such as 'Press top rocker' of a wireless pushbutton with a rocker; E2 initiates 'Press bottom rocker' (or 'right rocker' of a wireless pushbutton with double rocker in each case); E3 initiates like 'Press left top rocker' of a wireless pushbutton with a double rocker; and E4 initiates like 'Press left bottom rocker' of a wireless pushbutton with a double rocker. When the control contacts are opened, the telegram is the same as 'Release wireless pushbutton'.

The control inputs can be activated by internally placed jumpers either for pushbuttons (as-delivered state), window/door contacts or motion detectors.

With a cable length up to 10 metres, conventional pushbuttons, window/door contacts or floating motion detector contacts can be connected to terminals E1, E2, E3 and E4. The opposite pole in each case is GND.

The electronics is powered by an internal button cell CR2032.

To replace the battery or **activate battery supply**, open the housing and remove an insulation strip. The housing must also be opened to select the modes. To open the housing, use a screwdriver to release the tabs on the lid and then remove the lid.

F4USM61B	Wireless 4-way universal transmitter module	Art. No. 30000301	72,20 €/pc.
----------	---	-------------------	-------------

WIRELESS WEATHER DATA TRANSMITTER MODULE FWS61-24V DC, MULTI SENSOR MS AND WIDE-RANGE POWER SUPPLY UNIT WNT61-24VDC/10W

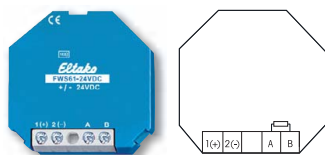

FWS61-24V DC



Wireless weather data transmitter module for the seven weather items sent by the multisensor MS. With internal antenna. Only 0.3 watt standby loss.

For installation. 45 mm long, 45 mm wide, 18 mm deep. Power (24V DC) is supplied by the wide-range power supply unit WNT61-24VDC/10W (33 mm deep, 45mm long, 45mm wide). This switching power supply unit simultaneously supplies the multisensor MS including the heating of the rain sensor. It is possible to use a deep UP box for the two devices.

This weather data transmitter module receives the seven momentary readings of the weather items: brightness (from three cardinal points), twilight, wind, rain and ambient temperature by cable J-Y (ST) Y 2x2x0,8 from the multisensor MS attached to the outside of the building. The readings are sent in the form of wireless telegrams over the Eltako wireless network with the priorities listed below. Only one MS multisensor can be connected to a wireless weather data transmitter module FWS61. However, several FWS61 can be connected to a multisensor MS. The external terminating resistor has to be present on only one FWS61. If there are other FWS61, it must be removed. The evaluation is made with a controller, the wireless multifunction sensor relay FMSR14, or the actuators FSB14 and FSB71. When the supply voltage is applied, a teach-in telegram is sent immediately and two status telegrams containing the momentary values are sent approx. 60 seconds later. At least every 10 minutes, but also: **Brightness values** West, South and East each from 0 to 99 kLux if a change of minimum 10% occurs. **Twilight values** from 0 to 999 Lux if a change of minimum 10% occurs. **Wind speeds** from 0 to 70m/s. From 4m/s to 16m/s, the momentary values are sent immediately 3 times at intervals of 1 second. After that, further value increases are sent within 20 seconds. Dropping wind speeds are sent progressively delayed by 20 seconds. **Rain** values at the start are sent immediately 3 times. After the rain stops, a telegram is sent within 20 seconds. **Temperature values** from -40.0°C to +80.0°C are sent every 10 minutes together with all the other values in a status telegram. **Monitoring multisensor function and line break.** If the weather data message from multisensor MS is not sent for 5 seconds, the FWS61 immediately sends an alarm telegram which is repeated every 30 seconds. The alarm telegram can be taught-in as a switch telegram in an actuator to initiate further action as required. In addition, the two status telegrams containing the values brightness 0 Lux, twilight 0 Lux, temperature -40°C (frost), wind 70 m/s and rain are sent. When a message is again detected from the multisensor MS, the alarm stops automatically.

FWS61-24V DC	Wireless weather data transmitter module	Art. No. 30000305	79,60 €/pc.
--------------	--	-------------------	-------------

MS



Multi sensor MS

The MS multi sensor sends the current weather details, including brightness (from three points of the compass), wind, rain and frost, to the weather data transmitter module FWS61 connected in series once per second. A standard telephone wire is sufficient as connecting lead: J-Y(ST)Y 2 x 2 x 0,8 or equivalent. 100 m line length is permitted. Solid plastic housing, LxWxH = 118x96x77mm. Degree of protection IP44. Temperature at mounting location -30°C to +50°C. A power supply unit WNT61-24VDC/10W is required for the power supply, including heating of the rain sensor. This simultaneously supplies the wireless weather data transmitter module FWS61-24V DC.

MS	Multi sensor	Art. No. 20000084	309,20 €/pc.
----	--------------	-------------------	--------------

WNT61-24VDC/10W



Wide-range switching power supply unit. Rated capacity 10 W. Standby loss 0.1 watt only.

Built-in device for installation. 45 mm long, 45 mm wide, 33 mm deep. Wide-range input voltage 88-264 V AC (110 V -20% up to 240 V +10%). Efficiency 86%. Stabilised output voltage ±1%, low residual ripple. Short-circuit proof. Overload protection and over-temperature switch-off by means of switching off with automatic switching-on after fault clearance (autorecovery function).

WNT61-24VDC/10W	Wide-range switching power supply unit 24V DC	Art. No. 61000265	47,20 €/pc.
-----------------	---	-------------------	-------------

3-36



Manuals and documents in further languages:
http://eltako.com/redirect/FWS61-24V_DC



Manuals and documents in further languages:
<http://eltako.com/redirect/MS>

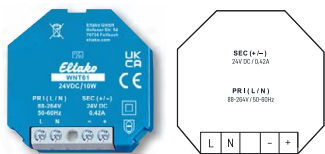

Manuals and documents in further languages:
http://eltako.com/redirect/WNT61-24VDC*10W

Technical data page 17-6.

Recommended retail prices excluding VAT.

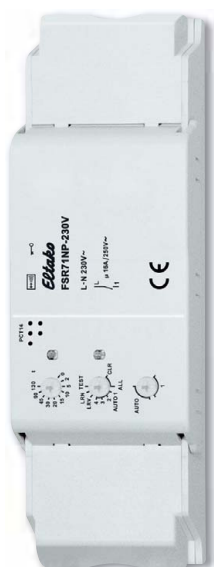

FSR71NP-230V



Impulse switch with integrated relay function, 1 NO contact not potential free 16 A/250 V AC, 230 V LED lamps up to 400 W, incandescent lamps 2000 watts. With light scene control by PC or wireless pushbuttons. Encrypted wireless, bidirectional wireless and repeater function are switchable. Only 0.8 watt standby loss.

3-37

Mounting in the 230 V power supply cord, e.g. in false ceilings and lamps.
166 mm long, 46 mm wide and 31 mm high. With cable fixation.

If supply voltage fails, the switching state is retained. When supply voltage is restored, the device is switched off in defined mode.

Scene control:

Several FSR71NP devices can be switched on or off in a scene by one of the four signals of a pushbutton with double rocker taught-in as a scene pushbutton.

Central commands via app are sent using a controller. To do this, teach-in one or several FSR71NP devices in the respective app.

Use the rotary switches to teach-in the pushbuttons and test the device as required. For normal mode, the middle and lower rotary switches are then set to AUTO. With the upper rotary switch the EW time (0-120 seconds) is directly set for relays or the RV time (0-120 minutes) for impulse switches for all channels if necessary.

If **wireless motion/brightness sensors FBH (Master) and/or FBH (slave)** are taught-in, the switching threshold will be set with the upper rotary switch, at which the lighting will be switched on or off. Settings of the upper rotary switch in accordance with operating manual.

When wireless brightness sensors are taught-in, define the switching threshold separately for each channel using the top rotary switch. The switching threshold switches the lighting on or off depending on the brightness (from approx. 0 lux in position 0 to approx. 50 lux in position 120). A hysteresis of approx. 300 lux is permanently set for switch on/off.

An additionally set RV time is not taken into account.

Only one FBH (Master) or FAH is taught-in per channel. However, one FBH or FAH can be taught-in in several channels.

When wireless window/door contacts FTK or window handle sensors FFG7B are taught-in, different functions can be set with the middle rotary switch in position AUTO 1 to AUTO 4 and linked to maximum 116 FTKs:

AUTO 1 = window closed then output active.

AUTO 2 = window open then output active.

In settings AUTO 3 and AUTO 4 the FTKs taught-in to a single channel are linked automatically. With AUTO 3 all FTKs must be closed so that the N/O contact closes (e.g. for climate control). With AUTO 4 one open FTK is sufficient to close the N/O contact (e.g. for an alarm signal or to switch on the power supply for an extractor hood).

One or several FTKs can be taught-in in several channels to allow several simultaneous functions in each FTK. After a power failure the link is restored by a new signal to the FTK and a signal on the next status message 15 minutes later.

An additionally set RV time is not taken into account.

When **water probes** are taught-in, a variety of functions can be set using the middle rotary switch in positions AUTO 1 to AUTO 4.

AUTO 1 = 'no water', then NO contact closed.

AUTO 2 = 'water', then NO contact closed.

In Positions AUTO 3 and AUTO 4 the water probes taught-in to a single channel are interlinked automatically. With AUTO 3, all water probes must signal 'no water' before the NO contact closes. The NO contact opens when a water probe signals 'water'. With AUTO 4, the NO contact closes when a water probe signals 'water'. Only when all water probes signal 'no water' does the NO contact open. An additionally set RV time is ignored.

The LED below the upper function rotary switch performs during the teach-in process according to the operating instructions. It shows control commands by short flickering during operation.

Function rotary switches

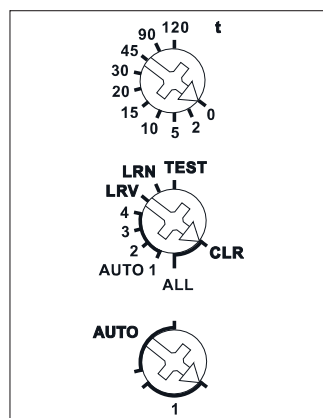

Standard setting ex works.

Further settings can be made and actuators configured using the PC Tool PCT14 and the data transformer DAT71.



Manuals and documents in further languages:
<http://eltako.com/redirect/FSR71NP-230V>

Technical data page T-3.

FSR71NP-230V	Wireless actuator Impulse switch with integr. relay function	Art. No. 30100865	95,50 € /pc.
---------------------	---	--------------------------	---------------------

WIRELESS ACTUATOR 2-CHANNEL IMPULSE SWITCH WITH INTEGRATED RELAY FUNCTION FSR71NP-2x-230V

3-38

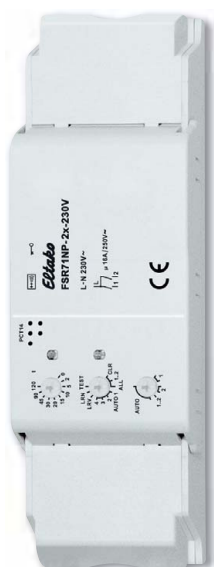

Function rotary switches

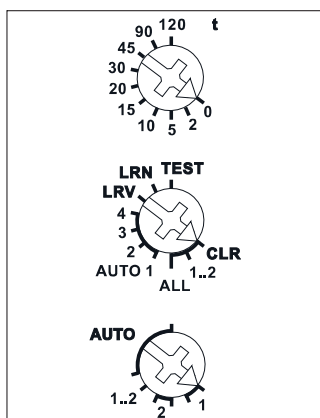

Standard setting ex works.

Further settings can be made and actuators configured using the PC Tool PCT14 and the data transformer DAT71.



Manuals and documents in further languages:
<http://eltako.com/redirect/FSR71NP-2x-230V>

Technical data page T-3.

FSR71NP-2x-230V



2-channel impulse switch with integrated relay function, 1 NO contact each not potential free 16 A/250 V AC, 230 V LED lamps up to 400 W, incandescent lamps 2000 watts. With light scene control by PC or wireless pushbuttons. Encrypted wireless, bidirectional wireless and repeater function are switchable. Only 0.8 watt standby loss.

Mounting in the 230 V power supply cord, e.g. in false ceilings and lamps.

166 mm long, 46 mm wide and 31 mm high. With cable fixation.

Maximum current as the sum of both contacts 16 A.

If supply voltage fails, the switching state is retained. When supply voltage is restored, the device is switched off in defined mode.

The channels can be taught-in as ES and/or ER channel separately from each other.

Scene control:

Several channels of one or several FSR71NP-2x devices can be switched on or off in a scene by one of the four signals of a pushbutton with double rocker taught-in as a scene button.

Central commands via app are sent using a controller. To do this, teach-in one or several FSR71NP-2x devices in the respective app.

Use the rotary switches to teach-in the pushbuttons and test the 2 channels as required. For normal mode, the middle and lower rotary switches are then set to AUTO. With the upper rotary switch the EW time (0-120 seconds) is directly set for relays or the RV time (0-120 minutes) for impulse switches for all channels if necessary.

If **wireless motion/brightness sensors FBH (Master) and/or FBH (slave)** are taught-in, the switching threshold will be set with the upper rotary switch, separated for each channel, at which the lighting will be switched on or off. Settings of the upper rotary switch in accordance with operating instructions.

When **wireless brightness sensors** are taught-in, define the switching threshold separately for each channel using the top rotary switch. The switching threshold switches the lighting on or off depending on the brightness (from approx. 0 lux in position 0 to approx. 50 lux in position 120). A hysteresis of approx. 300 lux is permanently set for switch on/off. An additionally set RV time is not taken into account.

Only one FBH or FAH is taught-in per channel. However, one FBH or FAH can be taught-in in several channels.

When wireless window/door contacts FTK or window handle sensors FFG7B are taught-in, different functions can be set with the middle rotary switch in position AUTO 1 to AUTO 4 and linked to maximum 116 FTKs:

AUTO 1 = window closed then output active.

AUTO 2 = window open then output active.

In settings AUTO 3 and AUTO 4 the FTKs taught-in to a single channel are linked automatically. With AUTO 3 all FTKs must be closed so that the N/O contact closes (e.g. for climate control). With AUTO 4 one open FTK is sufficient to close the N/O contact (e.g. for an alarm signal or to switch on the power supply for an extractor hood).

One or several FTKs can be taught-in in several channels to allow several simultaneous functions in each FTK. After a power failure the link is restored by a new signal to the FTK and a signal on the next status message 15 minutes later.

An additionally set RV time is not taken into account.

When **water probes** are taught-in, a variety of functions can be set using the middle rotary switch in positions AUTO 1 to AUTO 4.

AUTO 1 = 'no water', then NO contact closed.

AUTO 2 = 'water', then NO contact closed.

In Positions AUTO 3 and AUTO 4 the water probes taught-in to a single channel are interlinked automatically. With AUTO 3, all water probes must signal 'no water' before the NO contact closes. The NO contact opens when a water probe signals 'water'. With AUTO 4, the NO contact closes when a water probe signals 'water'. Only when all water probes signal 'no water' does the NO contact open. An additionally set RV time is ignored.

The LED below the upper function rotary switch performs during the teach-in process according to the operating instructions. It shows control commands by short flickering during operation.

FSR71NP-2x-230V	2 channel wireless actuator Impulse switch with integr. relay function	Art. No. 30200865	120,30 € /pc.
------------------------	---	--------------------------	----------------------

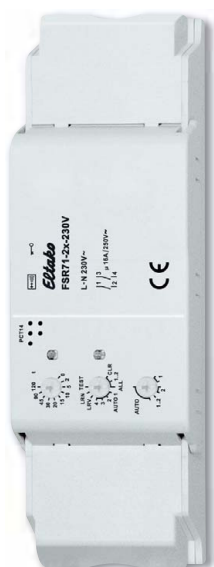

FSR71-2x-230V



2-channel impulse switch with integrated relay function, 1 NO contact each potential free 16 A/250 V AC, 230 V LED lamps up to 400 W, incandescent lamps 2000 watts. With light scene control by PC or wireless pushbuttons. Encrypted wireless, bidirectional wireless and repeater function are switchable. Only 0.8 watt standby loss.

Mounting in the 230 V power supply cord, e.g. in false ceilings and lamps.
166 mm long, 46 mm wide and 31 mm high. With cable fixation.

If supply voltage fails, the switching state is retained. When supply voltage is restored, the device is switched off in defined mode.

The channels can be taught-in as ES and/or ER channel separately from each other.

Scene control:

Several channels of one or several FSR71-2x devices can be switched on or off in a scene by one of the four signals of a pushbutton with double rocker taught-in as a scene button.

Central commands via app are sent using a controller. To do this, teach-in one or several FSR71-2x devices in the respective app.

Use the rotary switches to teach-in the pushbuttons and test the 2 channels as required. For normal mode, the middle and lower rotary switches are then set to AUTO. With the upper rotary switch the EW time (0-120 seconds) is directly set for relays or the RV time (0-120 minutes) for impulse switches for all channels if necessary.

If **wireless motion/brightness sensors FBH (Master) and/or FBH (slave)** are taught-in, the switching threshold will be set with the upper rotary switch, separated for each channel, at which the lighting will be switched on or off. Settings of the upper rotary switch in accordance with operating instructions.

When **wireless brightness sensors** are taught-in, define the switching threshold separately for each channel using the top rotary switch. The switching threshold switches the lighting on or off depending on the brightness (from approx. 0 lux in position 0 to approx. 50 lux in position 120). A hysteresis of approx. 300 lux is permanently set for switch on/off.

An additionally set RV time is not taken into account.

Only one FBH or FAH is taught-in per channel. However, one FBH or FAH can be taught-in in several channels.

When wireless window/door contacts FTK or window handle sensors FFG7B are taught-in, different functions can be set with the middle rotary switch in position AUTO 1 to AUTO 4 and linked to maximum 116 FTKs:

AUTO 1 = window closed then output active.

AUTO 2 = window open then output active.

In settings AUTO 3 and AUTO 4 the FTKs taught-in to a single channel are linked automatically. With AUTO 3 all FTKs must be closed so that the N/O contact closes (e.g. for climate control). With AUTO 4 one open FTK is sufficient to close the N/O contact (e.g. for an alarm signal or to switch on the power supply for an extractor hood).

One or several FTKs can be taught-in in several channels to allow several simultaneous functions in each FTK. After a power failure the link is restored by a new signal to the FTK and a signal on the next status message 15 minutes later.

An additionally set RV time is not taken into account.

When **water probes** are taught-in, a variety of functions can be set using the middle rotary switch in positions AUTO 1 to AUTO 4.

AUTO 1 = 'no water', then NO contact closed.

AUTO 2 = 'water', then NO contact closed.

In Positions AUTO 3 and AUTO 4 the water probes taught-in to a single channel are interlinked automatically. With AUTO 3, all water probes must signal 'no water' before the NO contact closes. The NO contact opens when a water probe signals 'water'. With AUTO 4, the NO contact closes when a water probe signals 'water'. Only when all water probes signal 'no water' does the NO contact open. An additionally set RV time is ignored.

The LED below the upper function rotary switch performs during the teach-in process according to the operating instructions. It shows control commands by short flickering during operation.

Function rotary switches

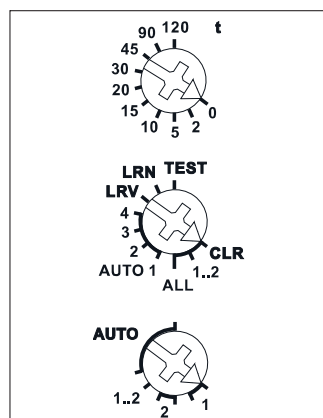

Standard setting ex works.

Further settings can be made and actuators configured using the PC Tool PCT14 and the data transformer DAT71.



Manuals and documents in further languages:
<http://eltako.com/redirect/FSR71-2x-230V>

Technical data page T-3.

FSR71-2x-230V	2 channel wireless actuator Impulse switch with integr. relay function	Art. No. 30200868	118,90 € / pc.
----------------------	---	--------------------------	-----------------------

WIRELESS ACTUATOR 4-CHANNEL IMPULSE SWITCH WITH INTEGRATED RELAY FUNCTION FSR71NP-4x-230V

3-40

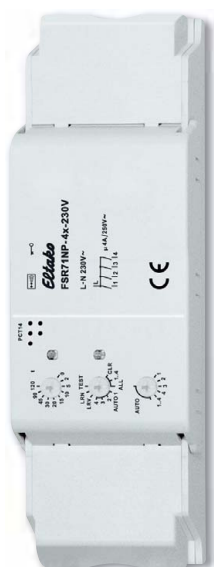

FSR71NP-4x-230V



4-channel impulse switch with integrated relay function, 1 NO contact each not potential free 4 A/250 V AC. 230 V LED lamps up to 200 W, incandescent lamps 1000 watts. With light scene control by PC or wireless pushbuttons. Encrypted wireless, bidirectional wireless and repeater function are switchable. Only 0.8 watt standby loss.

Mounting in the 230 V power supply cord, e.g. in false ceilings and lamps.

166 mm long, 46 mm wide and 31 mm high. With cable fixation.

If supply voltage fails, the switching state is retained.

The channels can be taught-in as ES and/or ER channel separately from each other.

Scene control:

Several channels of one or several FSR71NP-4x devices can be switched on or off in a scene by one of the four signals of a pushbutton with double rocker taught-in as a scene button.

Central commands via app are sent using a controller. To do this, teach-in one or several FSR71NP-4x devices in the respective app.

Use the rotary switches to teach-in the pushbuttons and test the 4 channels as required. For normal mode, the middle and lower rotary switches are then set to AUTO. With the upper rotary switch the EW time (0-120 seconds) is directly set for relays or the RV time (0-120 minutes) for impulse switches for all channels if necessary.

If **wireless motion/brightness sensors FBH (Master) and/or FBH (slave)** are taught-in, the switching threshold will be set with the upper rotary switch, separated for each channel, at which the lighting will be switched on or off. Settings of the upper rotary switch in accordance with operating instructions.

When **wireless brightness sensors** are taught-in, define the switching threshold separately for each channel using the top rotary switch. The switching threshold switches the lighting on or off depending on the brightness (from approx. 0 lux in position 0 to approx. 50 lux in position 120). A hysteresis of approx. 300 lux is permanently set for switch on/off.

An additionally set RV time is not taken into account.

Only one FBH or FAH is taught-in per channel. However, one FBH or FAH can be taught-in in several channels.

When wireless window/door contacts FTK or window handle sensors FFG7B are taught-in, different functions can be set with the middle rotary switch in position AUTO 1 to AUTO 4 and linked to maximum 116 FTKs:

AUTO 1 = window closed then output active.

AUTO 2 = window open then output active.

In settings AUTO 3 and AUTO 4 the FTKs taught-in to a single channel are linked automatically. With AUTO 3 all FTKs must be closed so that the N/O contact closes (e.g. for climate control). With AUTO 4 one open FTK is sufficient to close the N/O contact (e.g. for an alarm signal or to switch on the power supply for an extractor hood).

One or several FTKs can be taught-in in several channels to allow several simultaneous functions in each FTK. After a power failure the link is restored by a new signal to the FTK and a signal on the next status message 15 minutes later.

An additionally set RV time is not taken into account.

When **water probes** are taught-in, a variety of functions can be set using the middle rotary switch in positions AUTO 1 to AUTO 4.

AUTO 1 = 'no water', then NO contact closed.

AUTO 2 = 'water', then NO contact closed.

In Positions AUTO 3 and AUTO 4 the water probes taught-in to a single channel are interlinked automatically. With AUTO 3, all water probes must signal 'no water' before the NO contact closes. The NO contact opens when a water probe signals 'water'. With AUTO 4, the NO contact closes when a water probe signals 'water'. Only when all water probes signal 'no water' does the NO contact open. An additionally set RV time is ignored.

The LED below the upper function rotary switch performs during the teach-in process according to the operating instructions. It shows control commands by short flickering during operation.

Function rotary switches

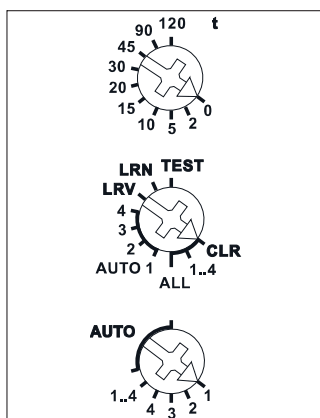

Standard setting ex works.

Further settings can be made and actuators configured using the PC Tool PCT14 and the data transformer DAT71.



Manuals and documents in further languages:
<http://eltako.com/redirect/FSR71NP-4x-230V>

Technical data page T-3.

FSR71NP-4x-230V	4 channel wireless actuator Impulse switch with integr. relay function	Art. No. 30400865	122,50 € /pc.
------------------------	---	--------------------------	----------------------

Recommended retail prices excluding VAT.



FUD71-230V



3-41

Universal dimmer switch, power MOSFET up to 400 W. Automatic lamp detection. With adjustable minimum brightness and dimming speed. With switching operation for light alarm clocks, children's rooms and snooze function as well as constant light regulation and master-slave mode. Also with light scene control by PC or wireless pushbuttons. Encrypted wireless, bidirectional wireless and repeater function are switchable. Only 0.7 watt standby loss.

Mounting in the 230 V power supply cord, e.g. in false ceilings and lamps.

166 mm long, 46 mm wide and 31 mm high. With cable fixation.

Universal dimmer switch for lamps up to 400 W, depending on ventilation conditions. Dimmable 230 V LED lamps and dimmable energy saving lamps ESL, additionally depending on the lamps electronics and the dimming technology, **see technical data page T-3.**

Zero passage switching with soft ON and soft OFF to protect lamps.

The brightness level is stored on switch-off (memory).

In case of a power failure the switch position and the brightness stage are stored and may be switched on when the power supply is restored.

Automatic electronic overload protection and overtemperature switch-off.

Encrypted sensors can be taught in.

You can switch on **bidirectional wireless** and/or a **repeater** function.

Every change in state and incoming central command telegrams are confirmed by a wireless telegram.

This wireless telegram can be taught-in in other actuators and controllers. The current dimming value is also displayed in % in the controller.

The upper rotary switch determines the operation, whether automatic lamp detection or special comfort positions should work:

AUTO allows the dimming of all lamp types.

LC1 is a comfort position for dimmable 230 V LED lamps, which by design won't be dimmed down enough in the AUTO position (trailing phase angle) and therefore has to be forced to leading phase angle.

LC2 and **LC3** are comfort positions for dimmable 230 V LED lamps like LC1 but with different dimming curves.

EC1 is a comfort position for energy saving lamps, which which by design must be turned on with an increased voltage so that they switch on again in cold state when dimmed down.

EC2 is a comfort position for energy saving lamps, which by design won't switch on again when dimmed down. Therefore Memory is switched off in this position.

In positions LC1, LC2, LC3, EC1 and EC2 inductive (wound) transformers may not be used. In addition, the maximum number of dimmable LED lamps may be lower by design than in the AUTO position.

LC4, LC5 and **LC6** are comfort positions for LED lamps like AUTO but with different dimming curves.

PCT is a position for special functions which were set up using the PCT14 PC Tool. The PCT14 link is hooked up using the data transformer DAT71.

The minimum brightness (fully dimmed down) is adjustable **with the middle % rotary switch.**

The dimming speed is adjustable **using the lower dimming speed rotary switch.**

The pushbuttons can be either taught-in as direction pushbuttons or universal pushbuttons: As

direction pushbutton 'switch on and dim up' is on one side and 'switch off and dim down' on the other side. A double-click on the switch on side triggers the automatic dimming up to full brightness with dim speed time. A double-click on the switch off side triggers the snooze function. The children's room function is triggered on the switch on side. **As a universal pushbutton** the direction change is made by briefly releasing the pushbutton.

For light scene control, constant light regulation, master-slave mode, light alarm clocks, children's rooms and snooze function see operating instructions.

A resettable staircase time switch function with RV = 2 minutes can be called by a pushbutton taught-in as a staircase pushbutton. Brightness level settings can be called during teach-in with single light scene pushbuttons. A twilight pushbutton can be implemented using a taught-in FAH. Switch-on can be performed dependent on motion and brightness with up to 4 FBH devices.

The LED accompanies the teach-in process and indicates control commands in operation by flashing briefly.

Function rotary switches

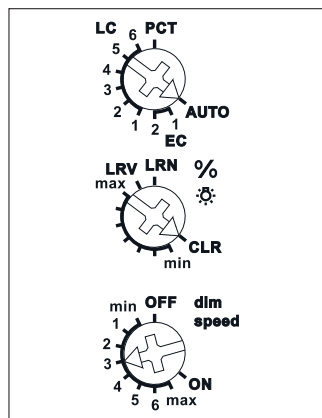

Standard setting ex works.

Further settings can be made and actuators configured using the PC Tool PCT14 and the data transformer DAT71.



Manuals and documents in further languages:
<http://eltako.com/redirect/FUD71-230V>

FUD71-230V	Wireless actuator Universal dimmer switch	Art. No. 30100845	124,40 € / pc.
------------	---	-------------------	----------------



Function rotary switches

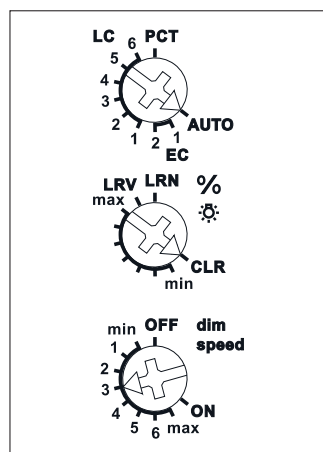

Standard setting ex works.

Further settings can be made and actuators configured using the PC Tool PCT14 and the data transformer DAT71.



Manuals and documents in further languages:
http://eltako.com/redirect/FUD71L*1200W-230V

Technical data page T-3.

FUD71L/1200W-230V



Universal dimmer switch, power MOSFET up to 1200 W. Automatic lamp detection. With adjustable minimum brightness and dimming speed. With switching operation for light alarm clocks, children's rooms and snooze function as well as constant light regulation and master-slave mode. Also with light scene control by PC or wireless pushbuttons. Encrypted wireless, bidirectional wireless and repeater function are switchable. Only 0.7 watt standby loss.

Mounting in the 230 V power supply cord, e.g. in false ceilings and lamps.

252 mm long, 46 mm wide and 31 mm high. With cable fixation.

Universal dimmer switch for lamps up to 1200 W, depending on ventilation conditions. Dimmable 230 V LED lamps and dimmable energy saving lamps ESL, additionally depending on the lamps electronics and the dimming technology, **see technical data page T-3.**

Zero passage switching with soft ON and soft OFF to protect lamps.

The brightness level is stored on switch-off (memory).

In case of a power failure the switch position and the brightness stage are stored and may be switched on when the power supply is restored.

Automatic electronic overload protection and overtemperature switch-off.

The upper rotary switch determines the operation, whether automatic lamp detection or special comfort positions should work:

AUTO allows the dimming of all lamp types.

LC1 is a comfort position for dimmable 230 V LED lamps, which by design won't be dimmed down enough in the AUTO position (trailing phase angle) and therefore has to be forced to leading phase angle.

LC2 and **LC3** are comfort positions for dimmable 230 V LED lamps like LC1 but with different dimming curves.

EC1 is a comfort position for energy saving lamps, which which by design must be turned on with an increased voltage so that they switch on again in cold state when dimmed down.

EC2 is a comfort position for energy saving lamps, which by design won't switch on again when dimmed down. Therefore Memory is switched off in this position.

In positions LC1, LC2, LC3, EC1 and EC2 inductive (wound) transformers may not be used. In addition, the maximum number of dimmable LED lamps may be lower by design than in the AUTO position.

LC4, LC5 and LC6 are comfort positions for LED lamps like AUTO but with different dimming curves.

PCT is a position for special functions which were set up using the PCT14 PC Tool. The PCT14 link is hooked up using the data transformer DAT71.

The minimum brightness (fully dimmed down) is adjustable **with the middle % rotary switch.**

The dimming speed is adjustable **using the lower dimming speed rotary switch.**

The pushbuttons can be either taught-in as direction pushbuttons or universal pushbuttons: As direction pushbutton 'switch on and dim up' is on one side and 'switch off and dim down' on the other side. A double-click on the switch on side triggers the automatic dimming up to full brightness with dim speed time. A double-click on the switch off side triggers the snooze function. The children's room function is triggered on the switch on side. **As a universal pushbutton** the direction change is made by briefly releasing the pushbutton.

For light scene control, constant light regulation, master-slave mode, light alarm clocks, children's rooms and snooze function see operating instructions.

A resettable staircase time switch function with RV = 2 minutes can be called by a pushbutton taught-in as a staircase pushbutton. Brightness level settings can be called during teach-in with single light scene pushbuttons. A twilight pushbutton can be implemented using a taught-in FAH. Switch-on can be performed dependent on motion and brightness with up to 4 FBH devices.

The LED accompanies the teach-in process and indicates control commands in operation by flashing briefly.

FUD71L/1200W-230V	Wireless actuator Universal dimmer switch	Art. No. 30100846	156,80 €/pc.
--------------------------	--	--------------------------	---------------------



FSG71/1-10V



Dimmer switch controller for electronic ballast units 1-10 V, 1 NO contact not potentialfree 600 VA and 1-10 V control output 40 mA. With adjustable minimum brightness and dimming speed. With switching operation for light alarm clocks, children's rooms and snooze function as well as constant light regulation and master-slave mode. Also with light scene control by PC or wireless pushbuttons. Encrypted wireless, bidirectional wireless and repeater function are switchable. Only 1 watt standby loss.

Mounting in the 230 V power supply cord, e.g. in false ceilings and lamps.
166 mm long, 46 mm wide and 31 mm high. With cable fixation.

Zero passage switching to protect lamps.

Also adapted for LED driver with 1-10 V passive interface, without voltage source up to 0.6 mA, above this value an additional voltage source is necessary.

The brightness level is stored on switch-off (memory).

In case of a power failure the switch position and the brightness stage are stored and may be switched on when the power supply is restored.

The minimum brightness (fully dimmed) is adjustable **with the % rotary switch.**

The dimming speed is adjustable **using the dimming speed rotary switch.**

The load is switched on and off by a bistable relay at output EVG. Switching capacity for fluorescent lamps or LV halogen lamps with EVG 600 VA.

By using a bistable relay coil power loss and heating is avoided even in the on mode.

After installation, wait for short automatic synchronisation before the switched consumer is connected to the mains.

The pushbuttons can be taught-in either as direction pushbuttons or universal pushbuttons: As a direction pushbutton, press up is brighter and press down is darker respectively above short pressing means switch ON and below short pressing switch OFF. A double click above activates automatic updimming until full brightness with dim speed. A double click below activates snooze function. The children's room function will be realized with the upper switch.

As a universal pushbutton, change the direction by briefly releasing the pushbutton. With switching operation for children's rooms and snooze function.

Light alarm circuit: An appropriately taught-in timer wireless signal starts the wake-up function by switching on the lighting at lowest brightness and slowly dimming up to maximum brightness over a period of 30 minutes. Briefly tip the pushbutton (e.g. a hand-held wireless transmitter) to stop dim-up. Light alarm circuit is not possible in EC positions.

Switching operation for children's rooms, if activated: If the light is switched on by holding down the pushbutton (universal pushbutton or direction pushbutton above), it starts at the lowest brightness level after approx. 1 second and dims up slowly as long as the pushbutton is held down. The last saved brightness level is not modified.

Snooze function, if activated: (universal pushbutton or direction pushbutton below): With a double impulse the lighting is dimmed down from the current dimming position to the minimum brightness level and switched off. The current dimming position as well as the adjustable minimum brightness level determine the dimming time (max. = 30 minutes) which can be reduced as required. It can be switched off at any time by short-time control commands during the lighting is dimmed down.

The LED below the upper function rotary switch performs during the teach-in process according to the operating instructions. It shows control commands by short flickering during operation.

Function rotary switches

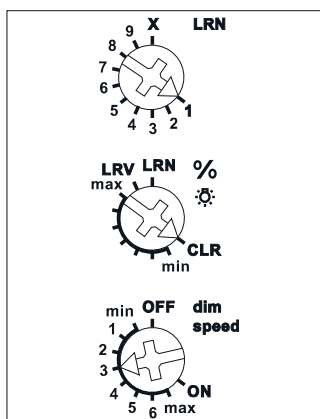

Standard setting ex works.

Typical connection

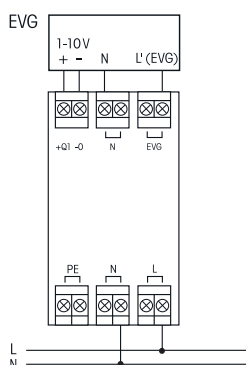

Further settings can be made and actuators configured using the PC Tool PCT14 and the data transformer DAT71.

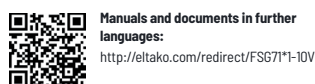

Technical data page T-3.

FSG71/1-10V	Wireless actuator Dimmer switch controller	Art. No. 30100841	115,40 €/pc.
--------------------	---	--------------------------	---------------------



FDG71L-230V



Wireless DALI gateway, bidirectional. 2 watt standby loss.

Installation for example in suspended ceilings and lamps.
 252 mm long, 46 mm wide and 31 mm high. With cable fixation.
 Power supply 230 V at terminals N and L.

16 V DC/130 mA can be connected to the DALI terminals +/- for up to 64 DALI devices.
 The gateway FDG71L controls DALI devices with EnOcean wireless transmitters.

Groups 0-15 can be controlled and the **broadcast command** can be sent. In addition **DALI scenes 0-15** can be controlled.

DALI installations, which are to be fully controlled with the FDG71L, must be configured in groups 0-15. The FDG71L internally saves the dimming value for each of the groups 0-15 and supplies this value as feedback. The same feedback telegrams are generated as for an FUD71.

The feedbacks of the device addresses correspond to the dimming values of the DALI groups 0-15 in ascending order.

Feedbacks can be converted by the PCT14 for each individual group of dimming value telegrams (%) to pushbutton telegrams (ON/OFF). Feedbacks can then control actuators.

The FDG71L fulfils the functions of the DALI master and the DALI power supply.

Important: Wireless pushbuttons always need to be double-clicked when they are taught-in manually in the FDG71L. CLR only needs a single click.

A direction pushbutton or universal pushbutton with identical ID and identical pushbutton can be taught in several times in different groups. The group last selected is always valid. Therefore, a pushbutton can either switch only one group or broadcast to all groups.

One FBH per group can also be taught in. With a manual teach-in this always acts dependent on brightness. With PCT14 you can also set the brightness threshold.

The delay time for switch-off after no motion is detected can be set together in minutes (1 ... 60) for the FBH devices of all groups. The default is 3 minutes.

Function rotary switches

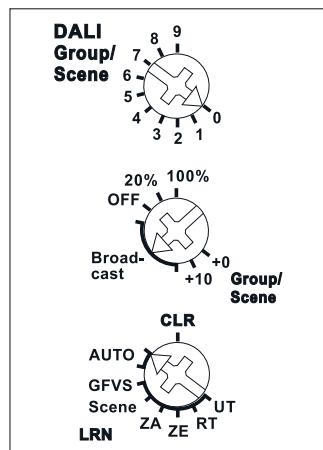

Standard setting ex works.

Further settings can be made and actuators configured using the PC Tool PCT14 and the data transformer DAT71.

FDG71L-230V	Wireless DALI gateway	Art. No. 30100867	144,60 €/pc.
--------------------	-----------------------	--------------------------	---------------------

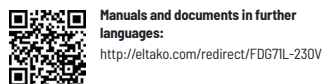

Technical data page T-3.

Recommended retail prices excluding VAT.



FRGBW71L



PWM dimmer switch with 4 channels for LED 12-36 V DC, each up to 2 A. Adjustable minimum brightness and dimming speed. With snooze function and light alarm circuit. Additionally with light scene control via PC or with wireless pushbuttons. Activation for encrypted wireless, bidirectional wireless and repeater function. Standby loss only 0.3-0.5 watt.

Installation for example in suspended ceilings and lamps.

252 mm long, 46 mm wide and 31 mm high. With cable fixation.

The set brightness level remains stored when switched off (memory).

In case of a power failure, the switch position and brightness level are saved and switched on when the power supply is restored.

Automatic electronic overload protection and overtemperature shutdown.

Encrypted sensors can be taught-in.

Bidirectional wireless and/or a **repeater function** can be switched on.

Every change in state and incoming central control telegrams are then confirmed by a wireless telegram.

The wireless telegram can be taught in other actuators and controllers. In addition the current dimming value is displayed in % in the controller.

The upper rotary switch is only required for teach-in.

Use the middle %  rotary switch to set the minimum brightness (fully dimmed).

Use the lower dimming speed rotary switch to set the dimming speed.

The pushbuttons can either be taught in as direction pushbuttons or universal pushbuttons: as direction pushbutton, one side is 'switch on and dim up'; the other side is 'switch off and dim down'. Double-click on the switch-on side to trigger automatic dim up to full brightness at dimming speed. Double-click on the switch-off side to trigger the snooze function.

As universal pushbutton, change the direction by briefly releasing the pushbutton.

FHB wireless motion/brightness sensors can be taught in as master or slave.

FAH wireless brightness sensors can be taught in for switch-off dependent on brightness or as a twilight switch.

Light scene control, light alarm circuit and snooze function as described in the operating instructions.

The LED accompanies the teach-in process as described in the operating instructions and indicates control commands by briefly flickering during operation.

Function rotary switches

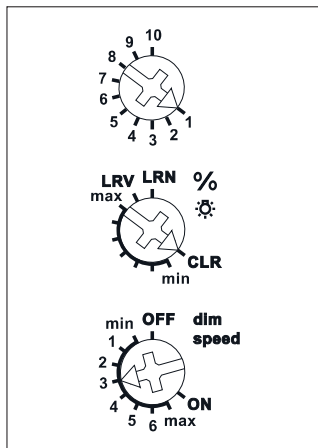

Standard setting ex works.

Further settings can be made and actuators configured using the PC Tool PCT14 and the data transformer DAT71.



Manuals and documents in further languages:
<http://eltako.com/redirect/FRGBW71L>

Technical data page T-3.

Recommended retail prices excluding VAT.

FRGBW71L	Wireless actuator PWM Dimmer Switch for LED	Art. No. 30400837	114,50 €/pc.
----------	--	-------------------	--------------



FWWKW71L



PWM dimmer switch with 2 channels for LED 12-36 V DC, each up to 4 A. Input: two terminals each for + and -. Output: one terminal for +, two terminal each for channel 1 (warm white) and channel 2 (cold white). Adjustable minimum brightness and dimming speed. With snooze function and light alarm circuit. Additionally with light scene control via PC or with wireless pushbuttons. Activation for encrypted wireless, bidirectional wireless and repeater function. Standby loss only 0.3-0.5 watt.

Installation for example in suspended ceilings and lamps. 252 mm long, 46 mm wide and 31 mm deep. With cable fixation.

The set brightness level remains stored when switched off (memory).

In case of a power failure, the switch position and brightness level are saved and switched on when the power supply is restored.

Automatic electronic overload protection and overtemperature shutdown.

Encrypted sensors can be taught-in.

Bidirectional wireless and/or a **repeater function** can be switched on.

Every change in state and incoming central control telegrams are then confirmed by a wireless telegram.

The wireless telegram can be taught in other actuators and controllers. In addition the current dimming value is displayed in % in the controller.

The upper rotary switch is only required for teach-in.

Use the middle %  rotary switch to set the minimum brightness (fully dimmed).

Use the lower dimming speed rotary switch to set the dimming speed.

The pushbuttons can either be taught in as direction pushbuttons or universal pushbuttons: as direction pushbutton, one side is 'switch on and dim up'; the other side is 'switch off and dim down'. Double-click on the switch-on side to trigger automatic dim up to full brightness at dimming speed. Double-click on the switch-off side to trigger the snooze function. **As universal pushbutton**, change the direction by briefly releasing the pushbutton.

FHB wireless motion/brightness sensors can be taught in as master or slave.

FAH wireless brightness sensors can be taught in for switch-off dependent on brightness or as a twilight switch.

Light scene control, light wake-up circuit and sleep circuit as described in the operating instructions.

The LED lights up during teach-in according to the operating instructions. Wireless control commands are indicated by short flickering during operation.

Function rotary switches

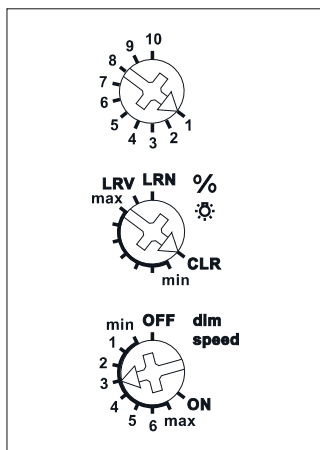

Standard setting ex works.

Further settings can be made and actuators configured using the PC Tool PCT14 and the data transformer DAT71.



Manuals and documents in further languages:
<http://eltako.com/redirect/FWWKW71L>

Technical data page T-3.

FWWKW71L	Wireless actuator PWM dimmer switch for LED	Art. No. 30200837	114,60 €/pc.
----------	--	-------------------	--------------



FSB71-230V



Switch actuator for shading elements and roller shutters for one 230 V motor. 1+1 NO contact 4 A/250 V AC, not potential free. Encrypted wireless, bidirectional wireless and repeater function are switchable. Only 0.8 watt standby loss.

Mounting in the 230 V power supply cord, e.g. in false ceilings. 166 mm long, 46 mm wide and 31 mm high. With cable fixation. **Zero passage switching to protect contacts and motors.** The motor is connected to 1, 2 and N. If supply voltage fails, the device is switched off in defined mode. **The pushbuttons can be taught-in either as direction pushbuttons or universal pushbuttons: Local control with universal pushbuttons:** With each impulse the switch position changes in the sequence 'Up, stop, Down, Stop'. **Local control with direction pushbutton:** A top impulse by pushbutton directly activates the 'UP' switch position. A bottom impulse by pushbutton directly activates the 'DOWN' switch position. A further impulse from one of the two pushbuttons stops the sequence immediately.

Central control dynamic without priority: A control signal from a pushbutton which was taught-in as a central control pushbutton without priority directly activates the switch position 'Up' with a scanning pulse up and the switch position 'Down' with a scanning pulse down. Without priority because this function can be overridden by other control signals.

Central control dynamic with priority: A control signal of min. 2 seconds from a pushbutton which was taught-in as a central control pushbutton with priority directly activates the switch position 'Up' (press top) and the switch position 'Down' (press bottom). With priority because these control signals cannot be overridden by other (local) control signals **until** the central control signal is cancelled by pressing again the central control pushbutton 'Up' or 'Down'.

The switch position 'up' or 'down' and the priority are specifically activated with a control signal, e.g. from a FSM61 taught-in with priority as a central pushbutton. With priority because these control signals cannot be overridden by other control signals **until** the central command is cancelled by the termination of the control signal.

Shading scene control: Up to 4 already stored 'Down' runtimes can be called using the control signal of a pushbutton with double rocker taught-in as a scene pushbutton or automatically using an additional taught-in wireless exterior brightness sensor.

When controlled via controller, Up and Down move commands can be started at the precise move time specified. Since the actuator reports back the precise time moved after each action, even when the movement is triggered by pushbutton, the position of the sunshading is always correctly displayed in the controller. When the top or bottom end position is reached, the position is automatically synchronised.

Function rotary switch below: AUTO 1 = In this position, the local advanced automatic reversing system for Venetian blinds is activated. When a universal pushbutton or a direction pushbutton are used for control a double impulse activates a slow rotation in the opposite direction, which can be stopped with a further impulse. **AUTO 2** = In this position, the local advanced automatic reversing system for Venetian blinds is completely switched off. **AUTO 3** = In this position, the local pushbuttons act static at first, thus, allow **reversal of Venetian blinds** by operating pushbuttons. They only switch to dynamic after 0.7 seconds continuous operation. **AUTO 4** = In this position, the local pushbuttons act only static (ER function). The time delay RV (wiping time) of the upper rotary switch is active. Central control is not possible.

▲▼ = ▲ (UP) and ▼ (DOWN) of the lower rotary switch are the positions for **manual control**. Manual control has priority over all other control commands. **WA = Automatic reversal** for Venetian blinds and awnings is controlled by the middle rotary switch. 0 = OFF, otherwise from 0.3 to 5 seconds ON with the selected reversal time. In this case, it is only for DOWN that the direction is reversed on time-out of the time lag selected by the top rotary switch, e.g. to extend awnings or set Venetian blinds to a defined position. A LED is located behind the RV-rotary switch to show the reversal time. **RV** = The **time delay** (delay time RV) is set by the top rotary switch. If the FSB is in the UP or DOWN position the selected delay time runs (elapses); at time-out the device changes automatically to STOP. Therefore, the time delay must be chosen at least as long as the shading element or roller shutter will need to move from one limit position to the other. The LED indication for the delay time RV is located behind the rotary switch RV.

When one or several wireless window/door contacts FTK or window handle sensors FFG7B are taught-in, a lock-out protection is set up while the door is open which prevents Central down and Scene down. **The LED** below the upper function rotary switch performs during the teach-in process according to the operating instructions. It shows control commands by short flickering during operation.

Function rotary switches

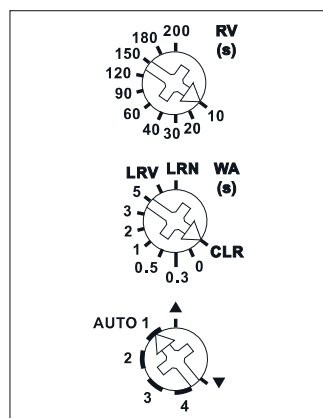

Standard setting ex works.

Further settings can be made and actuators configured using the PC Tool PCT14 and the data transformer DAT71.



Manuals and documents in further languages:
<http://eltako.com/redirect/FSB71-230V>

FSB71-230V	Wireless actuator for shading elements and roller shutters, 230 V	Art. No. 30200831	95,50 € / pc.
-------------------	---	--------------------------	----------------------

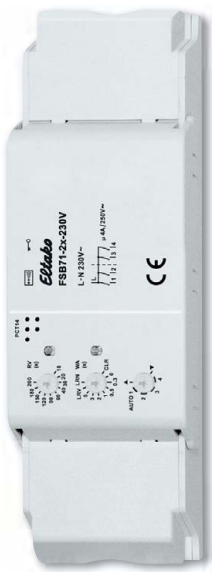

FSB71-2x-230V



Switch actuator for shading elements and roller shutters with 2 channels for two 230 V motors. 2+2 NO contact 4 A/250 V AC, not potential free. Encrypted wireless, bidirectional wireless and repeater function are switchable. Only 0.8 watt standby loss.

Mounting in the 230V power supply cord, e.g. in false ceilings. 166 mm long, 46 mm wide and 31 mm high. With cable fixation.

Zero passage switching to protect contacts and motors.

A motor is connected to 1, 2 and N; a second motor may be connected to 3, 4 and N.

If supply voltage fails, the device is switched off in defined mode.

The pushbuttons can be taught-in either as direction pushbuttons or universal pushbuttons: Local control with universal pushbuttons: With each impulse the switch position changes in the sequence 'Up, stop, Down, Stop'.

Local control with direction pushbutton: A top impulse by pushbutton directly activates the 'UP' switch position. A bottom impulse by pushbutton directly activates the 'DOWN' switch position. A further impulse from one of the two pushbuttons stops the sequence immediately.

Central control dynamic without priority: A control signal from a pushbutton which was taught-in as a central control pushbutton without priority directly activates the switch position 'Up' with a scanning pulse up and the switch position 'Down' with a scanning pulse down. Without priority because this function can be overridden by other control signals.

Central control dynamic with priority: A control signal of min. 2 seconds from a pushbutton which was taught-in as a central control pushbutton with priority directly activates the switch position 'Up' (press top) and the switch position 'Down' (press bottom). With priority because these control signals cannot be overridden by other (local) control signals **until** the central control signal is cancelled by pressing again the central control pushbutton 'Up' or 'Down'.

The switch position 'up' or 'down' and the priority are specifically activated with a control signal, e.g. from a FSM61 taught-in with priority as a central pushbutton. With priority because these control signals cannot be overridden by other control signals **until** the central command is cancelled by the termination of the control signal.

Shading scene control: Up to 4 already stored 'Down' runtimes can be called using the control signal of a pushbutton with double rocker taught-in as a scene pushbutton or automatically using an additional taught-in wireless exterior brightness sensor.

Shading scene control: Up to 4 already stored 'Down' runtimes can be called using the control signal of a pushbutton with double rocker taught-in as a scene pushbutton or automatically using an additional taught-in FAH60 wireless exterior brightness sensor.

When controlled via controller, Up and Down move commands can be started at the precise move time specified. Since the actuator reports back the precise time moved after each action, even when the movement is triggered by pushbutton, the position of the sunshading is always correctly displayed in the controller. When the top or bottom end position is reached, the position is automatically synchronised.

Function rotary switch below: AUTO 1 = In this position, the local **advanced automatic reversing system for Venetian blinds** is activated. When a universal pushbutton or a direction pushbutton are used for control a double impulse activates a slow rotation in the opposite direction, which can be stopped with a further impulse. **AUTO 2 =** In this position, the local advanced automatic reversing system for Venetian blinds is completely switched off. **AUTO 3 =** In this position, the local pushbuttons act static at first, thus, allow reversal of Venetian blinds by operating pushbuttons. They only switch to dynamic after 0.7 seconds continuous operation. **AUTO 4 =** In this position, the local pushbuttons act only static (ER function). The time delay RV (wiping time) of the upper rotary switch is active. Central control is not possible.

▲▼ = ▲ (UP) and ▼ (DOWN) of the lower rotary switch are the positions for **manual control**. Manual control has priority over all other control commands.

WA = Automatic reversal for Venetian blinds and awnings is controlled by the middle rotary switch. 0 = OFF, otherwise from 0.3 to 5 seconds ON with the selected reversal time. In this case, it is only for DOWN that the direction is reversed on time-out of the time lag selected by the top rotary switch, e.g. to extend awnings or set Venetian blinds to a defined position. A LED is located behind the RV-rotary switch to show the reversal time.

RV = The time delay (delay time RV) is set by the top rotary switch. If the FSB is in the UP or DOWN position the selected delay time runs (elapses); at time-out the device changes automatically to STOP. Therefore, the time delay must be chosen at least as long as the shading element or roller shutter will need to move from one limit position to the other. The LED indication for the delay time RV is located behind the rotary switch RV.

When one or several wireless window/door contacts FTK or window handle sensors FFG7B are taught-in, a lock-out protection is set up while the door is open which prevents Central down and Scene down.

The LED below the upper function rotary switch performs during the teach-in process according to the operating instructions. It shows control commands by short flickering during operation.

Function rotary switches

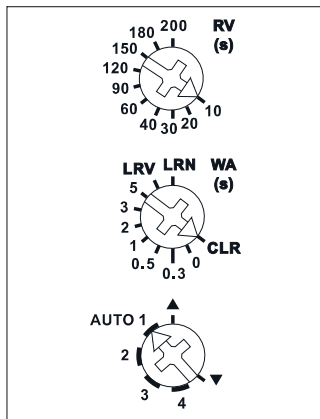

Standard setting ex works.

Further settings can be made and actuators configured using the PC Tool PCT14 and the data transformer DAT71.

Manuals and documents in further languages:
<http://eltako.com/redirect/FSB71-2x-230V>

Technical data page T-3.

FSB71-2x-230V	Wireless actuator for shading elements and roller shutters, 2 channels for two 230 V motors, 2+2 NO contact 4 A	Art. No. 30400868	119,60 € / pc.
----------------------	---	--------------------------	-----------------------



Manuals and documents in further languages:
<http://eltako.com/redirect/DAT71>

DAT71



Data transformer to configure Series 71 actuators using the PCT14 PC tool.

The DAT71 can be used to link an actuator to the PC. Using PCT14, data can be transferred to or from the actuator. In addition the DAT71 can be used as a mobile data storage.

The DAT71 must then be plugged into the actuator and connected to the PC by USB cable (not included in the scope of supply).

After starting the PCT14, configure the actuator.

3-49

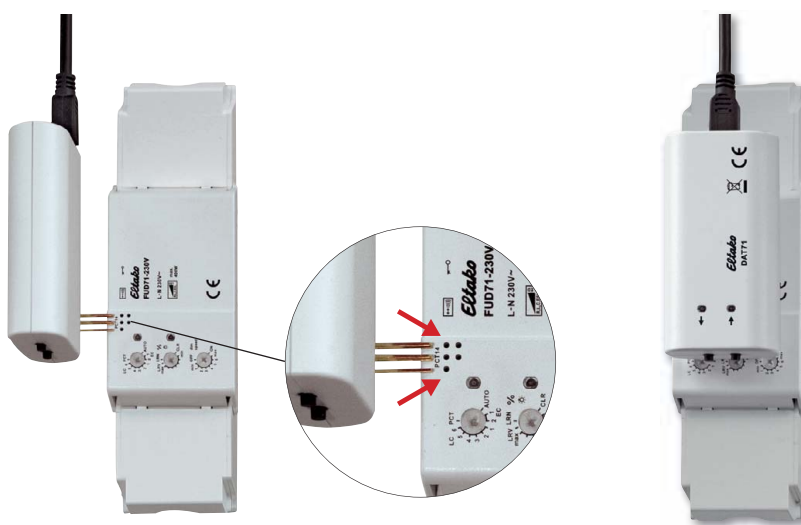

Plugging the data transformer DAT71 to a Series 71 actuator.

Technical data page T-3.

DAT71	Data transformer for Series 71	Art. No. 30000026	78,80 €/pc.
--------------	--------------------------------	--------------------------	--------------------

WIRELESS ACTUATOR IMPULSE SWITCH WITH INTEGR. RELAY FUNCTION FSR70S-230V AS CORD SWITCH

3-50



Function rotary switch
on the side

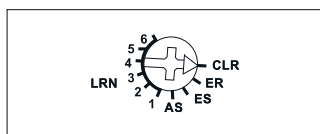

Standard setting ex works.



Manuals and documents in further
languages:
<http://eltako.com/redirect/FSR70S-230V>

Technical data page T-3.

FSR70S-230V



1 NO contact not potential free 10 A/250 V AC, 230 V LED lamps up to 400 W, incandescent lamps up to 2000 watts, energy saving lamps ESL up to 200 W. Only 0.8 watt standby loss.

Installation in the 230 V power supply cord of standard lamps and bedside lights.
100 mm long, 50 mm wide and 31 mm high.

This wireless actuator is an impulse switch with integrated relay function and features state-of-the-art hybrid technology that we developed: we combined the wear-free receiver and evaluation electronics and a bistable relay with zero passage switching.

By using a bistable relay coil power loss and heating is avoided even in the on mode.

With the rotary switch on the side in the settings LRN up to 35 wireless pushbuttons can be assigned, of which one or more central control pushbuttons. In addition, wireless motion/brightness sensor FBH and/or a wireless outside brightness sensor FAH for a presence simulation. The required function of the impulse switch with integrated relay function can then be selected:

ES = Impulse switch:

After the FBH is taught-in, the device switches on when movement is detected and, after an additional FAH is taught-in, at twilight and when movement is detected.

If no movement is detected, the contact opens after a 4 minute delay. A wireless switch can only be taught-in additionally to activate or deactivate presence simulation.

ER = Switching relay

When FAH is taught-in, the device switches on at twilight.

The contact opens after a 4 minute delay when brightness is detected.

AS = Presence simulation

The AS starts with a random pause time of 20 to 40 minutes followed by a random switch-on time of 30 to 120 minutes.

When the rotary switch is turned to AS or when the line voltage is switched on in AS position, the light switches on for 5 seconds after 1 second.

When the FAH is taught-in, the AS only starts when twilight commences.

After the FAH detects brightness, the AS ends after 4 minutes.

The LED on the side below the left rotary switch accompanies the teach-in process as described in the operation manual. It indicates control commands by short flickering during operation.

FSR70S-230V	Impulse switch with integr. relay function pure white	Art. No. 30100862	92,20 €/pc.
-------------	--	-------------------	-------------

ACCESSORIES: 1- AND 2-LEVEL WIRELESS REPEATER FRP70-230V AND 1- AND 2-LEVEL OUTDOOR WIRELESS REPEATER FARP60-230V



FA250



Manuals and documents in further languages:
<http://eltako.com/redirect/FRP70-230V>

FRP70-230V



1 and 2 level wireless repeater with small antenna and with antenna FA250. Only 0.6 watt standby loss. A wireless antenna FA250 or FAG55E- is connectable as required.

100 mm long, 50 mm wide and 25 mm deep.

Supply voltage 230 V. The housing must be opened to connect a 2-wire mains connection cable (e.g. with a Euro plug). Choose an elevated location for optimal function.

This repeater is only needed if the building conditions prevent undisturbed reception or the distance between the wireless pushbutton and receiver is too great. Antenna FA250 with 250 cm cable or FAG55E- with 100 cm cable is connectable instead of the enclosed antenna. The range can be extended considerably by placing it in the optimum position. The 1-level mode is activated ex works. Only wireless signals from sensors are received, tested and retransmitted at full transmit power. Wireless signals from other repeaters are ignored to reduce the data volume.

Use the rotary switch to switch over to 2 level mode. Then the wireless signals from sensors and from another 1 level repeater are processed. A signal may therefore be received and amplified twice.

The LED indicates incoming wireless signals by flashing briefly.

Wireless repeaters need not be taught-in. They receive and amplify signals from all wireless sensors within their reception area.

FRP70-230V	1- and 2-level wireless repeater	Art. No. 30000352	99,90 €/pc.
FA250	Wireless antenna with 250 cm cable, black	Art. No. 30000550	31,70 €/pc.
FA250-gw	Wireless antenna with 250 cm cable, grey white	Art. No. 30000553	31,70 €/pc.



Manuals and documents in further languages:
<http://eltako.com/redirect/FARP60-230V>

FARP60-230V



Outside wireless repeater 1 and 2 levels, 60 x 46 mm, 30 mm deep. Only 0.7 watt standby loss.

Supply voltage 230 V.

This repeater is only needed if the building conditions prevent undisturbed reception or the distance between the wireless pushbutton and receiver is too great.

The 1-level mode is activated ex works. Only the signals from sensors and actuators are received, tested and retransmitted at full transmit power. Wireless signals from other repeaters are ignored to reduce the data volume.

Switchover to 2-level mode is carried out by removing the cover (loosen two screws on the front panel) and repositioning the jumper flush right. In this setting, wireless signals from other 1-level repeaters are also processed. A signal may therefore be received and amplified twice.

A red LED blinks briefly to indicate all the wireless signals detected.

Wireless repeaters need not be taught-in. They receive and amplify signals from all wireless sensors within their reception area.

On the underside there is an M12 screw for a waterproof mains connection.

The protection class is IP54, the allowable ambient temperature is -20°C to +55°C.

For screw mounting.

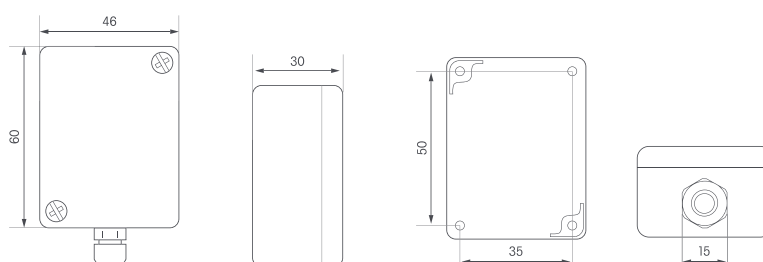

FARP60-230V	1- and 2-level outdoor wireless repeater	Art. No. 30000353	84,50 €/pc.
--------------------	--	--------------------------	--------------------



3-52



Manuals and documents in further languages:
http://eltako.com/redirect/FRP65*230V-wg

FRP65/230V-wg



**2 level wireless repeaters in the housing for single mounting 84 x 84 x 30 mm.
Only 0.8 watt standby loss.**

The mounting plate can be screwed over a flush-mounting box with a screw spacing of 60 mm.
Supply voltage 230 V.

This repeater is only needed if the building conditions prevent undisturbed reception or the distance between the wireless pushbutton and receiver is too great.

The 2-level mode is activated. The signals from sensors and actuators are received, tested and retransmitted with full transmitting power.

The wireless signals from another 1-level repeater are also being processed.

A signal may therefore be received and amplified twice.

Wireless repeaters need not be taught-in. They receive and amplify signals from all wireless sensors within their reception area.

FRP65/230V-wg	Wireless repeater pure white glossy	Art. No. 30065350	83,70 €/pc.
----------------------	-------------------------------------	--------------------------	--------------------

WIRELESS LIGHT ACTUATOR ADAPTER FSLA-230V WIRELESS ACTUATOR SOCKET SWITCHING ACTUATOR FSSA-230V



WEEE registration number DE 30298319



Manuals and documents in further languages:
<http://eltako.com/redirect/FSLA-230V>



WEEE registration number DE 30298319



Manuals and documents in further languages:
<http://eltako.com/redirect/FSSA-230V>

Technical data page T-3.

FSLA-230V



Wireless light actuator adapter 10 A/250 V AC. 100x55x45 mm (measurements without plug), pure white glossy. Impulse switch with NO contact. 230 V incandescent lamps and halogen lamps 1000 W, ESL and 230 V LED lamps up to 200 W. Bidirectional wireless and repeater function are switchable. Standby loss only 0.8 watt.

Adapter for German socket (Type F). With increased shock protection. Using easy tap-technology, up to 24 wireless universal pushbuttons, wireless direction pushbuttons, wireless central control pushbuttons, smoke alarms as well as motion sensors can be taught in.

FSLA-230V	Wireless light actuator adapter	Art. No. 30100020	84,60 €/pc.
------------------	---------------------------------	--------------------------	--------------------

FSSA-230V



1 NO contact not potential free 10 A/250 V AC, 230 V LED lamps and ESL up to 400 W, incandescent lamps up to 2000 watts. Encrypted wireless, bidirectional wireless and repeater function are switchable. Only 0.8 watt standby loss.

Adapter for German Socket (Typ F). With increased shock protection.
Supply and switching voltage 230 V.

In case of failure of the supply voltage, the switching state is maintained. The recurrent supply voltage is disconnected in a definite sequence. After plugging wait for short automatic synchronization before the switched consumer is plugged.

This wireless actuator features state-of-the-art hybrid technology that we developed: we combined the wear-free receiver and evaluation electronics and a bistable relay.

You can teach in encrypted sensors.

You can switch on **bidirectional wireless** and/or a **repeater** function.

Every change in state and incoming central command telegrams are then confirmed by a wireless telegram. This wireless telegram can be taught into other actuators, controllers and universal displays.

Up to 35 wireless pushbuttons are assigned **with the left button LRN**, either as a universal pushbutton, direction pushbutton or central pushbutton. For the control of extractor hoods or similar items up to 35 wireless window door contacts FTK or wireless window handle sensors FFG7B can be taught-in. Several FTK or wireless window handle sensors FFG7B are linked together.

If a FTK or wireless window handle sensor FFG7B is taught-in, control commands of eventually taught-in pushbuttons are no longer running.

It can be switched on and off manually **with the right button**.

The LED performs during the teach-in process according to the operation manual. It shows wireless control commands by short flickering during operation.

FSSA-230V	Wireless actuator Socket switching actuator	Art. No. 30100001	113,80 €/pc.
------------------	--	--------------------------	---------------------

WIRELESS OUTDOOR SOCKET SWITCH ACTUATOR FASSA-230V
WIRELESS OUTDOOR SOCKET ENERGY METER FASWZ-16A

3-54



WEEE-Reg.-Nr. DE 30298319



Manuals and documents in further languages:
<http://eltako.com/redirect/FASSA-230V>



WEEE-Reg.-Nr. DE 30298319



Manuals and documents in further languages:
<http://eltako.com/redirect/FASWZ-16A>

FASSA-230V



1 NO contact not potential free 16 A/250 V AC, 230 V LED lamps and ESL up to 400 W, incandescent lamps 2300 Watt. 116x56x46 mm (measurements without plug), black. Suitable for both indoors and outdoors, IP44 (splash-proof). Encrypted wireless, bidirectional wireless and repeater function are switchable. Only 0.4 watt standby loss.

Adapter for German Socket (Type F). With increased shock protection.

Supply and switching voltage 230 V.

Zero passage switching.

Bistable relay to prevent coil power loss and the associated heat generation in switched state.

After plugging wait for short automatic synchronization before the switched consumer is plugged.

In case of failure of the supply voltage, the switching state is maintained.

The recurrent supply voltage is disconnected in a definite sequence.

FASSA-230V	Wireless outdoor socket switch actuator	Art. No. 30100011	112,00 €/pc.
-------------------	---	--------------------------	---------------------

FASWZ-16A



Wireless outdoor socket energy meter, maximum current 16 A. 116x56x46 mm (measurements without plug), black. Suitable for both indoors and outdoors, IP44 (splash-proof). Only 0.4 watt standby loss.

Adapter for German Socket (Type F). With increased shock protection.

This single-phase energy meter measures active energy by means of the current between input and output and transmits the consumption and meter reading over the Eltako wireless network.

Accuracy class B (1%).

Evaluation and smart connection via a controller.

The internal power consumption of max. 0.4 watt active power is not metered.

The inrush current is 20 mA.

The consumption is saved to a non-volatile memory and is immediately available again after a power failure.

Wireless telegrams: A telegram is transmitted within 30 seconds if the power status changes by min. 10 percent. A change in meter reading is transmitted immediately.

A full telegram comprising meter reading and power status is transmitted every 10 minutes.

After plugging in the counter and also when pressing the *LRN* button, a **learn telegram**, a counter reading telegram and a power telegram are sent.

FASWZ-16A	Wireless outdoor socket energy meter	Art. No. 30100015	114,90 €/pc.
------------------	--------------------------------------	--------------------------	---------------------



WEEE registration number DE 30298319



Manuals and documents in further languages:
<http://eltako.com/redirect/FSVA-230V-10A>

Technical data page T-3.

FSVA-230V-10A



1 NO contact not potential free 10 A/250 V AC, 230 V LED lamps and ESL up to 400 W, incandescent lamps up to 2000 watts. With integrated current measurement up to 10 A. Encrypted wireless, bidirectional wireless and repeater function are switchable. Only 0.8 watt standby loss.

Adapter for German Socket (Typ F). With increased shock protection.

Supply and switching voltage 230 V.

In case of failure of the supply voltage, the switching state is maintained. The recurrent supply voltage is disconnected in a definite sequence. After plugging wait for short automatic synchronization before the switched consumer is plugged.

This wireless actuator features state-of-the-art hybrid technology that we developed: we combined the wear-free receiver and evaluation electronics and a bistable relay.

Apparent power is measured by the integrated current measurement from approx. 10 VA to 2300 VA when the contact is closed. A wireless telegram is transmitted into the Eltako wireless network within 30 seconds after switching on the load or after a change in power by min 5% and cyclically every 10 minutes.

Evaluation on smartphone or tablet with a controller.

You can teach in encrypted sensors.

You can switch on **bidirectional wireless** and/or a **repeater** function.

Every change in state and incoming central command telegrams are then confirmed by a wireless telegram. This wireless telegram can be taught into other actuators, controllers and universal displays.

Up to 35 wireless pushbuttons are assigned **with the left button LRN**, either as a universal pushbutton, direction pushbutton or central pushbutton. For the control of extractor hoods or similar items up to 35 wireless window door contacts FTK or wireless window handle sensors FFG7B can be taught-in.

Several FTK or wireless window handle sensors FFG7B are linked together.

If a FTK or wireless window handle sensor FFG7B is taught-in, control commands of eventually taught-in pushbuttons are no longer running.

It can be switched on and off manually **with the right button**.

The LED performs during the teach-in process according to the operation manual. It shows wireless control commands by short flickering during operation.

FSVA-230V-10A	Wireless actuator Socket switching actuator with current measurement	Art. No. 30100003	121,50 €/pc.
----------------------	--	--------------------------	---------------------

3-56



Manuals and documents in further languages:
<http://eltako.com/redirect/FSUD-230V>

WEEE registration number DE 30298319

Technical data page T-3.

FSUD-230V



Universal dimmer switch, 300 W power MOSFET. Automatic lamp detection. Only 0.7 watt stand-by loss. With adjustable minimum brightness. With switching operation for children's rooms and snooze function. Encrypted wireless, bidirectional wireless and repeater function are switchable.

Adapter for German Socket (Typ F). With increased shock protection.

Supply and switching voltage 230 V.

Universal dimmer switch for lamps up to 300 W. Dimmable 230 V-LED lamps and dimmable energy saving lamps ESL, dependent on the lamps electronics.

Zero passage switching with soft ON and soft OFF to protect lamps.

No minimum load required.

This dimmer switch is activated by wireless pushbuttons FT and FFT, handheld wireless transmitters FHS and FMH, and remote controls FF8 and UFB.

The set brightness level is stored when switched off (memory), but can be switched off for ESL lamps.

In case of a power failure the switch position and the brightness stage are stored and may be switched on when the power supply is restored.

Automatic electronic overload protection and overtemperature switch-off.

You can teach in encrypted sensors.

You can switch on **bidirectional wireless** and/or a **repeater** function.

Every change in state and incoming central command telegrams are then confirmed by a wireless telegram. This wireless telegram can be taught into a controller. The current dimming value is also displayed in % in the respective app.

Up to 35 wireless pushbuttons are assigned **with the left button LRN**, either as a universal pushbutton, direction pushbutton or central pushbutton.

It can be switched on and off manually **with the right button**.

The pushbuttons can be either taught-in as direction pushbuttons or universal pushbuttons: As direction button 'switch on and dim up' is on one side and 'switch off and dim down' on the other side. A double-click on the switch on side triggers the automatic dimming up to full brightness. A double-click on the switch off side triggers the snooze function. The children's room function is triggered on the switch on side. **As a universal pushbutton** the direction change is made by briefly releasing the pushbutton.

For children's room circuit and sleep timer, refer to the operating instructions.

The LED performs during the teach-in process according to the operation manual. It shows wireless control commands by short flickering during operation.

FSUD-230V	Wireless actuator Socket universal dimmer switch	Art. No. 30100002	140,20 €/pc.
------------------	---	--------------------------	---------------------



Manuals and documents in further languages:
<http://eltako.com/redirect/FSHA-230V>

FSHA-230V



1 NO contact nor potential free 10 A/250 V AC. Encrypted wireless, bidirectional wireless and repeater function switchable. Only 0.8 watt standby loss.

Adapter for German Socket (Typ F). With increased shock protection.

Supply and switching voltage 230 V. Zero passage switching.

If a power failure occurs, the switching state is retained.

Device is programmed to switch off when the power supply is restored.

The FSHA evaluates the data of wireless temperature controllers or sensors. Can be supplemented by window/door contacts, window handles, motion detectors and wireless pushbuttons.

After installation, wait for short automatic synchronisation before the switched consumer is connected to the mains.

Encrypted sensors can be taught in.

Bidirectional wireless and/or a **repeater** function can be switched on.

Every change of state is then confirmed by a wireless telegram.

This wireless telegram can be taught in other actuators and controllers.

The FSHA operates as a two-point controller:

Switches off at 'actual temperature \geq set temperature'.

Switches off at 'actual temperature \geq set temperature'.

Hysteresis is defined at 1°.

The **frost protection function** is always enabled. As soon as the actual temperature drops below 8°C, the temperature is regulated to 8°C.

If one or several windows are open, the output remains off **provided the window/door contacts or window handles** are taught-in. However, the frost protection remains enabled.

As long as all taught-in **motion detectors** detect no motion, the device is switched to setback mode and the reference temperature is set back by 2°. As soon as a motion detector signals movement again, the device is switched to normal mode.

When a **wireless pushbutton** is taught-in, the assignment of the 4 keys is assigned with the following fixed functions:

Top right: Normal mode (AUTO), can also be enabled by timer.

Bottom right: Night setback mode by 4°, can also be enabled by timer.

Top left: Setback mode by 2°

Bottom left: Off (frost protection enabled)

If the motion detector and wireless pushbutton are taught-in at the same time, the last telegram received is always the one that is valid. A motion detector therefore switches off a setback mode selected by wireless pushbutton when a movement is detected.

Malfunction mode:

If a temperature sensor fails to receive a wireless telegram for longer than 1 hour, the LED lights up and the device switches to fault mode. The FSHA-230V switches cyclically between 'ON' for 4.5 minutes and 'OFF' for 10.5 minutes. When a wireless telegram is again received, the LED goes out and the device switches back to normal mode.

The LED lights up during teach-in according to the operating instructions. Wireless control commands are indicated by short flickering during operation.

WEEE registration number DE 30298319

Technical data page T-3.

FSHA-230V	Wireless actuator Wireless socket heating actuator	Art. No. 30100008	119,70 €/pc.
------------------	---	--------------------------	---------------------

WIRELESS GARAGE DOOR ADAPTER FGTZ-230V AND 1- AND 2-LEVEL WIRELESS SOCKET REPEATER FSRP-230V

3-58



WEEE registration number DE 30298319



Manuals and documents in further languages:
<http://eltako.com/redirect/FGTZ-230V>



WEEE registration number DE 30298319



Manuals and documents in further languages:
<http://eltako.com/redirect/FSRP-230V>

FGTZ-230V



Wireless garage door adapter. 100x55x45 mm (measurements without plug), pure white. With potential-free switching contact output for a maximum of 30V/1A. Encrypted wireless, bidirectional wireless and repeater function are switchable. Standby loss only 0,8 watt.

Adapter for German fused safety sockets. With increased shock protection.

The schuko socket (16 A) is directly connected to the schuko plug, so no mains socket is blocked and the mains plug of the garage door drive can be plugged in directly here. In order to control the garage door drive with additional wireless buttons, its connection terminals for an external, potential-free button (contact) are connected to the plug-in screw terminals of the potential-free switch contact output of the actuator.

Only safety extra-low voltage (SELV) may be switched!

With the convenient tapping technique, up to 24 wireless universal buttons and wireless direction buttons can be taught-in. In order for the radio direction switch to function as such, a radio window / door contact must also be taught-in. This reports whether the garage door is open or closed.

FGTZ-230V	Wireless garage door adapter	Art. No. 30000379	88,90 €/pc.
-----------	------------------------------	-------------------	-------------

FSRP-230V



1- and 2-level wireless socket repeater. Only 0.7 watt standby loss.

Adapter for German Socket (Typ F). With increased shock protection.

This repeater is only needed if the building conditions do not allow undisturbed reception or the distance between the wireless pushbutton and receiver is too great.

The 2-level mode is activated ex works. Sensor wireless signals are then processed in addition to the wireless signals of another 1-level repeater. A wireless signal can then receive and amplify a maximum of two times.

From production week 31/18: By multiple unplugging and plugging can be switched to the 1-level mode.

Now only the wireless signals from sensors are received and amplified. Wireless signals from other repeaters are ignored to reduce the amount of data.

Activate 1-level mode:

Briefly unplug and replug the adapter plug 3 times at intervals of 1 second within a period of 10 seconds.

Activate 2-level mode:

Briefly unplug and replug the adapter plug 5 times at intervals of 1 second within a period of 20 seconds.

Wireless repeaters need not be taught-in. They receive and amplify signals from all wireless sensors within their reception area.

FSRP-230V	1- and 2-level wireless socket repeater	Art. No. 30000359	84,30 €/pc.
-----------	---	-------------------	-------------

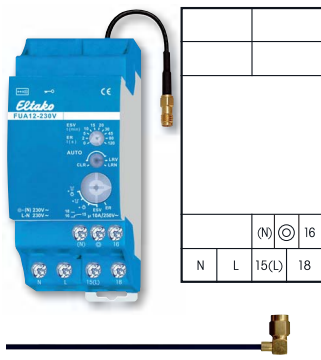

The enclosed small antenna can be replaced with a wireless antenna FA250 or if need be FA200 and FAG55E- (see page 1-4).

Function rotary switches

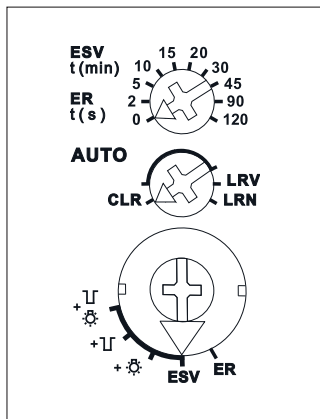

Standard setting ex works.

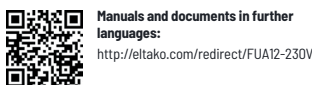

FUA12-230V



Wireless universal actuator with exchangeable antenna. Impulse switch with integrated relay function with 1 change over contact potential free 10 A/250 V AC, incandescent lamps up to 2000 W, with DX technology. Bidirectional. Encrypted wireless. Only 0.9 watt standby loss.

A wireless antenna FA250 or FAG55E- is connectable as required. Modular device for DIN-EN 60715 TH35 rail mounting. 2 modules = 36 mm wide, 58 mm deep. Supply voltage 230 V.

The wireless universal actuator combines the functions of a wireless antenna module and an actuator as a 1-channel impulse switching relay with DX technology.

If supply voltage fails, the switching state is retained. When supply voltage is restored, the device is switched off in defined mode. The switched consumer may not be connected to the mains before the short automatic synchronisation after installation has terminated. Patented Eltako Duplex technology allows you to switch normally potential free contacts in zero passage switching when 230 V A/C voltage 50 Hz is switched. This drastically reduces wear. To achieve this, simply connect the N conductor to the terminal (N) and L to 15(L). This results in an additional standby consumption of only 0.1 watt.

It is also possible to control the device via the wired pushbutton terminal ☉. In this case the N wire must be connected on the terminal (N). Glow lamp current is not permitted.

230 V control pushbutton: control current: 0,4 mA, max. parallel capacitance 0.3 µF (approx. length) of (1000 m) local control lead.

You can switch on **bidirectional wireless** and/or a **repeater** function. Every status change and incoming central control telegrams are then confirmed by a wireless telegram. This wireless telegram can be taught-in in other actuators, controllers and in universal displays.

The function of the actuator is set **with the lower rotary switch.**

- ER** = switching relay
- ESV** = impulse switch. Possibly with off delay
- + ☉ = ESV with pushbutton permanent light
- + ⏏ = ESV with switch-off early warning
- + ⏏ + ☉ = ESV with pushbutton permanent light and switch-off early warning

If the permanent light function is switched on, the function can be activated by pressing the pushbutton for longer than 1 second. This function switches off automatically after 2 hours or by pressing the pushbutton.

If the switch-off early warning is switched on, the light starts to flicker approx. 30 seconds before time-out. This is repeated three times at decreasing time intervals.

The function **ESV on the upper rotary switch** sets the off delay from 2 to 120 minutes. In setting 0 normal impulse switch function ES without off delay, without pushbutton permanent light and without switch-off early warning.

In setting ER = switching relay of the lower rotary switch, this rotary switch fulfils a safety and power saving function in the settings except 0: If the opening command cannot be detected, for example, because of a jammed or too hastily operated pushbutton, contact 18 opens automatically after expiry of the set time between 2 and 120 seconds. When a FTK is taught-in, this time function is turned off.

Universal pushbuttons can be taught-in as **NC contacts.**

FTK wireless window/door contact and window handle sensors FFG7B: ER function position: Several FTK devices and (or) window handle sensors FFG7B are interlinked; NO contact: When a window is opened, contact 18 closes. All windows must be closed before contact 18 opens (e.g. controller for cooker extraction hoods). NC contact: All windows must be closed before contact 18 closes. When a window is opened, contact 18 opens (e.g. for climate control systems).

Twilight pushbutton with taught-in FAH wireless outdoor brightness sensor in function position ESV. In time setting 120, contact 18 opens with a time delay of 4 minutes when brightness reaches high enough levels. In time setting 0, the contact opens immediately. Pushbutton activation also remains available.

Motion detection with taught-in **FBH (slave)** wireless motion detector and in ER function position. The device switches on when motion is detected. If no more motion is detected, contact 18 opens after expiry of the set time between 0 and 120 seconds. When an **FBH (master)** wireless detector and brightness detector is taught-in, use the upper rotary switch to define the switching threshold at which the lighting is switched on or off depending on the brightness (in addition to motion). An FAH wireless outdoor brightness sensor or an FBH (master) wireless motion detector and brightness sensor can be used in ER function position together with FBH (slave) motion detector so that motion is only evaluated in darkness. If FAH or FBH (master) detects brightness, contact 18 opens immediately.

When teaching-in, the switching threshold is also taught-in: between break of twilight and complete darkness.

The LED performs during the teach-in process according to the operating instructions. It shows wireless control commands by short flickering during operation.

FUA12-230V	Wireless universal actuator	Art. No. 30000052	121,80 €/pc.
-------------------	-----------------------------	--------------------------	---------------------

WIRELESS ACTUATOR WIRELESS MODULE FGM WIRELESS ALARM CONTROLLER FAC55D/230V-

3-60

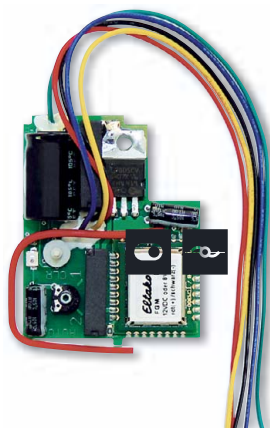

Manuals and documents in further languages:
<http://eltako.com/redirect/FGM>

FGM



Wireless module for fitting in the 3xAA battery compartment of gongs or any other plastic housing. Only 0.5 watt standby loss.

52 mm long, 42 mm wide and 16 mm deep.

This wireless module is suitable for all gongs that can be powered with 3 pieces AA batteries or with 8 to 12 V UC transformer connection and activated by one contact.

The gong module FGM also fits in the much larger battery compartment for 3 or 4 pieces baby cells.

The gong module is placed in the battery compartment in accordance with the operating instructions and connected to the gong terminals.

The gong and the wireless module is powered by a wide-range power supply unit WNT61-12VDC/10W which is fitted in a flush-mounted wall socket behind the gong and requires a 230 V connection.

Normal switches can also be connected to the appropriate gong terminals.

For teaching-in a rotary switch is located on the board. Then it is set to AUTO (clockwise).

In addition to one or several wireless switches, wireless window/door contacts FTK, motion detector/brightness sensors FBH and window handle sensors FFG7B can be taught in.

The LED performs during the teach-in process according to the operation manual. It shows wireless control commands by short flickering during operation.

Examples of suitable gongs:

Friedland D844

Grothe Croma 100

FGM	Wireless module	Art. No. 30000040	82,00 €/pc.
-----	-----------------	-------------------	-------------



Manuals and documents in further languages:
http://eltako.com/redirect/FAC55D*230V-

FAC55D/230V-



Wireless alarm controller for single mounting 80 x 80 x 14 mm or mounting into the E-Design55 switching system. Installation depth 33 mm. Illuminated display. Internal acoustic signal generator for a minimum volume of 80 dB. Supply voltage 230 V. Only 0.5 watt standby loss.

Smart Home actuator.

Up to 50 sensors e.g. FTK, FTKB, mTronic, FTKE, FFG7B, FBH, FRW, FRWB, FWS, FTR, FTF, FFT60SB, FLGTF65, wireless pushbuttons and controllers can be taught in as described in the operating instructions.

Additionally, up to 4 wireless outdoor sirens FAS260SA can be taught in.

FAC55D/ 230V-wg	Wireless alarm controller 55 x 55 mm with display, pure white glossy	Art. No. 30000727	104,00 €/pc.
--------------------	--	-------------------	--------------



Manuals and documents in further languages:
<http://eltako.com/redirect/FIUS55E->



WEEE registration number DE 30298319



Manuals and documents in further languages:
<http://eltako.com/redirect/FSSG-230V>

FIUS55E-



Wireless signal generator for single mounting 80 x 80 x 17 mm or mounting into the E-Design55 switching system. Internal acoustic signal generator for a minimum volume of 80 dB. Power supply 230 V. Only 0.8 watt standby loss. Smart Home actuator.

Up to 32 wireless pushbuttons, wireless window contacts as well as motion sensors can be taught in.

FIUS55E-am	Wireless indoor UP signal generator, anthracite mat	Art. No. 30055069	86,40 €/pc.
FIUS55E-pg	Wireless indoor UP signal generator, polar white glossy	Art. No. 30055070	86,40 €/pc.
FIUS55E-pm	Wireless indoor UP signal generator, polar white mat	Art. No. 30055071	86,40 €/pc.
FIUS55E-wg	Wireless indoor UP signal generator, pure white glossy	Art. No. 30055068	86,40 €/pc.

FSSG-230V



Wireless signal generator adapter 10 A/250 V AC. 100 x 55 x 45 mm (measurements without plug), pure white glossy. Additional an internal acoustic signal generator with a volume of at least 80 dB will flash a load connected to the plug. 230 V incandescent lamps and halogen lamps 1000 W, ESL and 230 V LED lamps up to 200 W. Bidirectional wireless is switchable. Standby loss only 0.8 watt. Smart Home actuator.

Adapter for German Socket (Typ F) with increased shock protection.

Using easy tap-technology, up to 24 wireless pushbuttons, wireless window contacts, window handle, smoke alarms, water probes, as well as motion sensors FB55EB and FBH55ESB can be taught in.

The acoustic signal generator can be deactivated.

FSSG-230V	Wireless signal generator adapter	Art. No. 30000358	101,90 €/pc.
------------------	-----------------------------------	--------------------------	---------------------



Manuals and documents in further languages:
<http://eltako.com/redirect/FAS260SA>

FAS260SA



Wireless outdoor siren white, 260 x 200 x 70 mm, with solar cell and lithium-polymer battery. Protection class IP54. Smart Home actuator.

The purpose of the siren is to generate acoustic and visual alarm signals. The user can choose from 4 different alarm modulations by means of jumpers. The minimum volume is 85 dB. Visual signals are always generated by LEDs flashing under the red cover.

The siren is controlled by the central control units Safe, MiniSafe or the wireless alarm controllers FAC55D and FAC65D.

Sensors that trigger alarms are taught in at the central control units or controllers. Sensor devices include motion sensors, door/window contacts, water and smoke detectors, temperature sensors and wireless transmitter modules.

The user defines which sensors trigger an alarm and in which combination.

This is supported by a cyclical wireless contact between the siren and the central unit.

If this communication is interrupted during the alarm readiness, for example if the central control unit is not powered, the following may take place depending on the position of the jumpers in the siren:

- No reaction
- 2 short acoustic or visual signals at intervals of 10 seconds (as-delivered state)
- Short 1 second acoustic and visual alarm at intervals of 10 seconds
- Alarm triggered immediately

The maximum length of the alarm is adjustable to 1, 3 or 5 minutes by means of jumpers in the siren.

The as-delivered state is adjusted to 1 minute.

Install the siren in a place that is sheltered from the rain and where there is enough sunlight to charge the solar cell on the top of the device.

A daily exposure to normal daylight for a few hours is sufficient to retain the charge in the internal battery.

To protect against theft or manipulation, the mounting panel is fitted with a contact which immediately triggers the alarm if the siren is removed from its mount.

FAS260SA	Wireless outdoor siren, white	Art. No. 30000041	130,50 €/pc.
----------	-------------------------------	-------------------	--------------



Manuals and documents in further languages:
http://eltako.com/redirect/FRM60M*

FRM60M10 AND FRM60M20



Wireless tubular motors 230 V/115 W for steel shafts SW60, torque 10 Nm resp. 20 Nm, speed 14/min, with adapter set, bearing and whisper mode. The wireless tubular motors have a total length of 466 mm resp. 526 mm. The motors are fitted with blind protection and a noiseless soft brake.

- Smart force measurement
- Blind protection up/down and free travel (torque shut-off)
- Adjustable release
- End positions can be adjusted through the assembly cable
- Noiseless soft brake
- Protection class IP44
- Long running time of 10 minutes
- Drive technology with well proven track record
- Extremely quiet
- End positions released
- Blind protection function
- Whisper mode (activated by holding button down)
- Slats lowered slowly
- Soft start/soft stop
- Automatic commands in whisper mode
- Long service life (due to less heat generated)
- Soft brake (non-contact, wear-free)

3-63

FRM60M10	Wireless tubular motor, torque 10 Nm, speed 14/min, whisper mode 5/min	Art. No. 30000048	266,30 €/pc.
FRM60M20	Wireless tubular motor, torque 20 Nm, speed 14/min, whisper mode 5/min	Art. No. 30000049	304,30 €/pc.

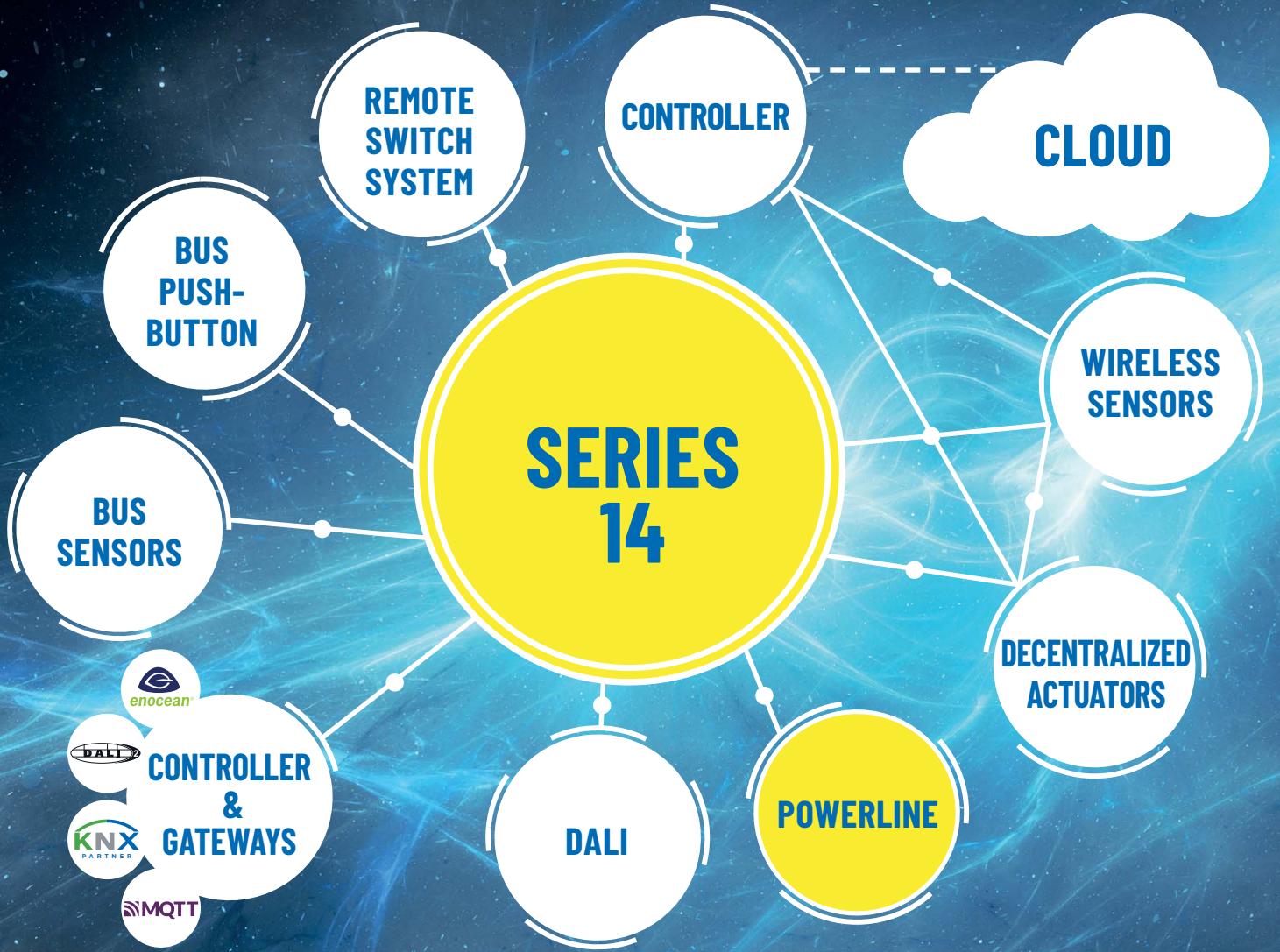

**PL-SAMDU
FPLG14**

4

**ELTAKO POWERLINE
THE IDEAL ADDITION TO THE WIRELESS SYSTEM.**

Eltako Powerline

Wireless Powerline tunnel gateway FPLT14 and wireless Powerline gateway FPLG14	4-2
Powerline gateway PL-FGW and Powerline repeater PL-RPT	4-3
Decentralised actuator PL-SAMIL with sensor input 230 V and decentralised actuator PL-SAM2L with sensor inputs	4-4
Decentralised Venetian blind actuator PL-SAM2 with sensor inputs	4-5
Decentralised universal dimmer actuator PL-SAMDU with sensor input 230 V and decentralised dimmer actuator PL-AMD10V with 1-10 Volt	4-6
Decentralised TLZ actuator PL-SAMILT with sensor input 230 V and decentralised actuator PL-SMIL with sensor input 230 V	4-7
Decentralised 8-channel sensor input PL-SM8 and temperature controller PL-SAMTEMP for heating and cooling	4-8
Coupling element PL-SW-PROF for PC software SIENNA®-Professional and mains filter NF2A	4-9
Typical connections	4-10
Technical data Powerline devices	4-11

The electricity wiring in buildings acts as the Eltako Powerline bus. Now you can transmit sensor data and telegrams to actuators over the existing electricity wiring instead of broadcasting wireless telegrams – that is the basic difference between the two technologies.

WIRELESS POWERLINE TUNNEL GATEWAY FPLT14 AND WIRELESS POWERLINE GATEWAY FPLG14

4-2

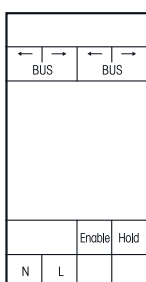

Function rotary switches

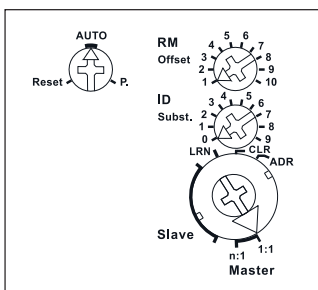

Standard setting ex works.



Manuals and documents in further languages:
<http://eltako.com/redirect/FPLT14>

FPLT14



Wireless Powerline tunnel gateway. Uni- and bidirectional. Standby loss only 0.4 watt.

Modular device for DIN-EN 60715 TH35 rail mounting.

2 module = 36 mm wide, 58 mm deep.

Supply voltage 230 V.

Connection to the Eltako-RS485 bus. Bus cross wiring and power supply with jumper.

This gateway transmits RS485 bus telegrams over powerline with large distance over the electrical net. Minimum 2 pcs FPLT14 are required.

Up to 10 FPLT14 can unidirectionally send the bus telegrams of their FAM14 / FTS14KS installation with Powerline to another FAM14 / FTS14KS installation via a local FPLT14.

Teach-in up to 120 telegram IDs according to the operating instructions, also with PCT14.

Two FPLT14 can exchange the bus telegrams bidirectionally from 2 FAM14 / FTS14KS installations with Powerline via the installed wires. Teach-in up to 120 telegram IDs according to the operating instructions, also with PCT14. Because of the transmission delay, short-click evaluations for FUD and FSB actuators are not possible.

FPLT14	Wireless Powerline tunnel gateway	Art. No. 30014078	100,00 €/pc.
--------	-----------------------------------	-------------------	--------------

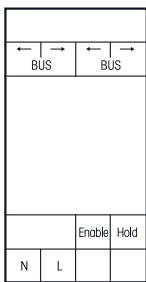

Function rotary switches

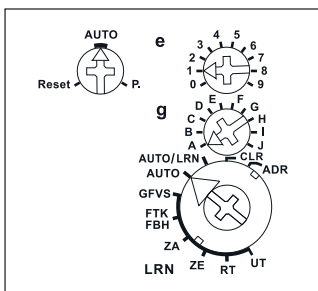

Standard setting ex works.



Manuals and documents in further languages:
<http://eltako.com/redirect/FPLG14>

FPLG14



Wireless Powerline gateway. Bidirectional. Standby loss only 0.4 watt.

Modular device for DIN-EN 60715 TH35 rail mounting.

2 module = 36 mm wide, 58 mm deep.

Supply voltage 230 V.

Connection to the Eltako-RS485 bus. Bus cross wiring and power supply with jumper.

This gateway translates wireless and Powerline telegrams in both directions.

Operation in conjunction with FAM14 or FTS14KS.

Controller control functions for dimming, heating and shading are also possible.

All Powerline telegrams from the electricity wiring system are automatically translated into RS485 bus telegrams and may also be sent as wireless telegrams by connected FTD14 devices.

Only wireless and RS485 bus telegrams taught into the FPLG14 are translated into Powerline telegrams and modulated onto the electricity wiring system. Up to 120 different addresses. Teach-in takes place by means of rotary switches on the front of the devices or using the PCT14 as described in the user's manual.

FPLG14	Wireless Powerline gateway	Art. No. 30014070	100,00 €/pc.
--------	----------------------------	-------------------	--------------



Manuals and documents in further languages:
<http://eltako.com/redirect/PL-FGW>

PC software SIENNA-Professional
page 4-9.

PL-FGW



Powerline wireless gateway. Bidirectional. 53x43 mm, 40 mm deep for mounting in 58 mm switch boxes. Standby loss 1.1 watt.

Supply voltage 230 V. Power consumption in operation 1.1 watt.

Powerline telegrams from the grid taught-in into the gateway are automatically transformed and sent into Eltako-wireless telegrams.

Wireless telegrams taught-in into the gateway are transformed into powerline telegrams and modulated to the power supply grid.

By pressing the reset button, the PL-FGW will be put into the teaching-in mode. The rotary switch selects, whether wireless or powerline telegrams should be taught-in.

One being taught powerline sensor is automatically assigned by operating in the learning mode, a free radio channel.

Up to 80 Powerline sensors or feedbacks can be taught-in. The function as a universal, direction or central pushbutton for a taught-in wireless sensor is assigned via slide switch of the PL-FGW. The Powerline address is set via rotary switch g and e which should be addressed with the wireless sensor. In addition to wireless switches also Eltako wireless sensors such as window contacts and motion detectors can be taught-in. Also control functions of the controller for dimmer switches and roller shutter control is possible. The implementation into practical Powerline telegrams für PL actuators is done automatically. Up to 100 different wireless sensor can be taught-in.

All entries and configurations can also be accessed via the mains using the Sienna Professional PC software (see page 4-9). This can then be used to select other functions that are not available through direct teach-in using a rotary switch. In addition, the gateway can be set into the learn and deletion mode, so that a manual teaching-in can be carried out without direct access to the device.

The PL-FGW also serves as a relay station for communication between the temperature controller PL-SAMTEMP with EnOcean actuator FKS-MD1. Up to 20 actuators and PL-SAMTEMP are managed here.

4-3

PL-FGW	Powerline wireless gateway	Art. No. 31100010	150,60 €/pc.
--------	----------------------------	-------------------	--------------



Manuals and documents in further languages:
<http://eltako.com/redirect/PL-RPT>

PC software SIENNA-Professional
page 4-9.

PL-RPT



Powerline repeater. 53x43 mm, 25 mm deep for mounting in 58 mm switch boxes. Standby loss only 0,5 watt.

The repeater supports greater ranges. With cable lengths of > 300 m the repeater is normally located in a distributor between the sensor and the actuator.

The repeater repeats commands from sensors with the same address g, e.

Feedback messages from actuators are not repeated.

Two rotary switches are located on the front to assign addresses:

The left-hand rotary switch determines the group address g with 16 alphanumeric digits from A to P.

The right-hand rotary switch determines the element address e with 16 numerical values.

Above it is a slide switch which is a **configuration switch with positions 0, 1 and 2.**

Position 0: Central commands are repeated irrespective of the repeater's e address. With address g, e=0, only central commands are repeated.

Position 1: With address g, e=0 at the repeater, all commands of group g are repeated.

Position 2: Unassigned.

All entries and configurations can also be accessed via the mains using the Sienna Professional PC software (see page 4-9). Addresses can be changed live or without voltage.

On the left of the rotary switches is a red LED to display all activities.

Next to that is the Reset button and to the right of that is Service Pin (P).

The terminals located above are plug-in terminals for conductor cross-sections of 0.2 mm² to 1.5 mm².

PL-RPT	Powerline repeater	Art. No. 31000030	101,70 €/pc.
--------	--------------------	-------------------	--------------

DECENTRALISED ACTUATOR PL-SAM1L WITH SENSOR INPUT 230 V AND DECENTRALISED ACTUATOR PL-SAM2L WITH SENSOR INPUTS



Manuals and documents in further languages:
<http://eltako.com/redirect/PL-SAM1L>

4-4

PC software SIENNA-Professional
page 4-9.

Typical connections on page 4-10.

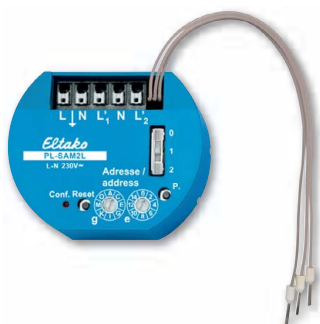

Manuals and documents in further languages:
<http://eltako.com/redirect/PL-SAM2L>

PC software SIENNA-Professional
page 4-9.

Typical connections on page 4-10.

PL-SAM1L



Powerline actuator with 1 channel with sensor input. 53 x 43 mm, 25 mm deep, for mounting in 58 mm switch boxes. Used as impulse switch or relay. 1 NO contact not potential free 10 A/250 V AC, incandescent lamps 2000 watts. Sensor input 230 V. Standby loss only 0,5 watt. To control and switch at the same place.

Two rotary switches are located on the front for address assignment:

The left rotary switch defines the group address g with 16 alphabetical values from A to P.

The right rotary switch defines the element address e with 16 numerical values from 0 to 15.

Above it is a slide switch which acts **as a configuration switch with positions 0, 1 and 2.**

Position 0: Sensor input functions as pushbutton (impulse switch).

Position 1: Sensor input functions as NO contact (relay).

Position 2: A change-over switch is evaluated as a pushbutton.

All entries and configurations can also be accessed via the mains using the PC software SIENNA Professional (see page 4-9). This means that another configuration can also be set that is not available via the rotary switches:

Position 3: Sensor input acts as NO contact (relay inverse).

To the left of the rotary switches is a red LED which indicates all activities.

Next to it is a reset pushbutton and to the right of that is a service pin. For functions, please refer to the operating instructions.

The terminals located above are plug-in terminals for conductor cross-sections of 0.2 mm² to 1.5 mm².

PL-SAM1L	Powerline actuator 1 channel with sensor input 230 V	Art. No. 31100001	113,30 €/pc.
-----------------	--	--------------------------	---------------------

PL-SAM2L



Powerline actuator with 2 channels. 53 x 43 mm, 25 mm deep for mounting in 58 mm switch boxes. Used as impulse switch or relay. 1+1 NO contacts not potential free 5 A/250 V AC, incandescent lamps 1000 watts. 2 sensor inputs with internal low voltage. Standby loss only 0,5 watt. To control and switch at the same place.

Use only potential free switching elements. Internal low voltage applied to the sensor inputs.

Two rotary switches are located on the front for address assignment:

The left rotary switch defines the group address g with 16 alphabetical values from A to P.

The right rotary switch defines the element address e with 16 numerical values from 0 to 15.

Above it is a slide switch which acts as a configuration switch with positions 0, 1 and 2.

Position 0: Sensor inputs function as pushbuttons (impulse switches).

Position 1: Sensor input functions as NC contact (relay).

Position 2: A change-over switch is evaluated as a pushbutton.

All entries and configurations can also be accessed via the mains using the PC software SIENNA Professional (see page 4-9). This means that another configuration can also be set that is not available via the rotary switches:

Position 3: Sensor input acts as NO contact (relay inverse).

To the left of the rotary switches is a red LED which indicates all activities.

Next to it is a reset pushbutton and to the right of that is a service pin. For functions, please refer to the operating instructions.

The terminals located above are plug-in terminals for conductor cross-sections of 0.2 mm² to 1.5 mm².

Next to them are three wires with wire end-sleeves for the two control inputs with internal low voltage.

PL-SAM2L	Powerline actuator 2 channels with 2 sensor inputs	Art. No. 31200001	115,30 €/pc.
-----------------	--	--------------------------	---------------------



Manuals and documents in further languages:
<http://eltako.com/redirect/PL-SAM2>

PC software SIENNA-Professional
 page 4-9.

Typical connections on page 4-10.

PL-SAM2



Powerline Venetian blind actuator for 1 motor. 53 x 43 mm, 25 mm deep for mounting in 58 mm switch boxes. 1+1 NO contact for motors up to 3 A. 2 sensor inputs with internal low voltage. Standby loss only 0,5 watt. To control and switch at the same place.

Use only potential free switching elements. Internal low voltage applied to the sensor inputs. The control inputs can be used for a Venetian blind pushbutton or a Venetian blind switch. The runtime is preset to 120 seconds. This can be changed using the PC software **SIENNA-Professional**. Two rotary switches are located on the front for address assignment:

The left rotary switch defines the group address g with 16 alphabetical values from A to P.
The right rotary switch defines the element address e with 16 numerical values from 0 to 15.

Above it is a slide switch which acts **as a configuration switch with positions 0, 1 and 2.**

Position 0: Start and stop by pressing Venetian blind pushbutton. Auto stop at end.

Position 1: Comfort switch for Venetian blind slat adjustment. Tip briefly to adjust slats.

>1 second same as position 0.

Position 2: Tip pushbutton to operate, release to stop. Auto stop at end.

To the left of the rotary switches is a red LED which indicates all activities.

Next to it is a reset pushbutton and to the right of that is a service pin. For functions, please refer to the operating instructions.

The terminals located above are plug-in terminals for conductor cross-sections of 0.2 mm² to 1.5 mm².

Next to them are three wires with wire end-sleeves for the two control inputs with internal low voltage.

PL-SAM2	Powerline Venetian blind actuator for 1 motor	Art. No. 31100002	115,30 €/pc.
----------------	---	--------------------------	---------------------

DECENTRALISED UNIVERSAL DIMMER ACTUATOR WITH SENSOR INPUT 230 V PL-SAMDU AND DECENTRALISED DIMMER ACTUATOR 1-10 VOLT PL-AMD10V



Manuals and documents in further languages:
<http://eltako.com/redirect/PL-SAMDU>

4-6

PC software SIENNA-Professional
page 4-9.

Typical connections on page 4-10.



Manuals and documents in further languages:
<http://eltako.com/redirect/PL-AMD10V>

PC software SIENNA-Professional
page 4-9.

Typical connections on page 4-10.

Recommended retail prices excluding VAT.

PL-SAMDU



Powerline universal dimmer actuator. 53 x 43 mm, 40 mm deep for mounting in 58 mm switch boxes. Power MOSFET up to 300 W. Automatic lamp detection. Sensor input 230 V. Standby loss only 0,6 Watt. To control and dim at the same place.

Universal dimmer switch for lamps up to 300 W, dependent on ventilation conditions. Dimmable 230 V-LED lamps and dimmable energy saving lamps ESL, additionally dependent on the lamps electronics. No minimum load.

Zero passage switching with soft ON and soft OFF to protect lamps.

Short-time control commands switch on/off, permanent control varies the brightness to the maximum or minimum level. A interruption of control changes the direction of dimming. The brightness level is stored on switch-off (memory). Minimum and maximum brightness can be changed with SIENNA Professional.

In case of a power failure the switch position and the brightness stage are stored and may be switched on when the power supply is restored.

Automatic electronic overload protection and overtemperature switch-off.

Two rotary switches are located on the front for address assignment:

The left rotary switch defines the group address g with 16 alphabetical values from A to P.

The right rotary switch defines the element address e with 16 numerical values from 0 to 15.

Above it is a slide switch which acts **as a configuration switch:**

The position AUTO1 allows the dimming of all types of lamps up to 300 watts.

The position LC1 is a comfort position for LED lamps up to 150 watts which are not being dimmed down enough when set to AUTO (trailing phase angle) dependent on the construction and must therefore be forced to leading phase angle.

The position AUTO2 allows the dimming of all types of lamps up to 300 watts.

Increased minimum brightness compared to AUTO1.

All entries and configurations can also be accessed via the mains using the PC software SIENNA Professional (see page 4-9).

In position LC1 no inductive (wound) transformers should be used. In addition, the maximum number of dimmable LED lamps can be lower than in the AUTO position dependent on the construction.

Mixing of L loads (inductive loads, e.g. wound transformers) and C loads (capacitive loads, e.g. electronic transformers) is not permitted. R loads (ohmic loads, e.g. 230V incandescent lamps and halogen lamps) may be added anytime.

To the left of the rotary switches is a red LED which indicates all activities.

Next to it is a reset pushbutton and to the right of that is a service pin. For functions, please refer to the operating instructions.

The terminals located above are plug-in terminals for conductor cross-sections of 0.2 mm² to 1.5 mm².

PL-SAMDU	Powerline universal dimmer actuator 1 channel with sensor input 230 V	Art. No. 31100008	130,70 €/pc.
-----------------	--	--------------------------	---------------------

PL-AMD10V



Powerline dimmer actuator 1-10 V. 53 x 43 mm, 25 mm deep, for mounting in 58 mm switch boxes. To switch and/or dim via a 1-10 V interface. 1 NO non-floating contact 600 VA. Standby loss only 0,5 watt. To activate and dim at different places.

Current sink of max. 30 mA for active and passive electronic ballasts. A Powerline sensor input is required for activation. Two rotary switches are located on the front for address assignment:

The left rotary switch defines the group address g with 16 alphabetical values from A to P.

The right rotary switch defines the element address e with 16 numerical values from 0 to 15.

Above it is a slide switch which has no function here.

All entries and configurations can also be accessed via the mains using the PC software SIENNA Professional (see page 4-9). Minimum and maximum brightness can be changed with SIENNA Professional.

To the left of the rotary switches is a red LED which indicates all activities. Next to it is a reset pushbutton and to the right of that is a service pin. For functions, please refer to the operating instructions.

The terminals located above are plug-in terminals for conductor cross-sections of 0.2 mm² to 1.5 mm².

PL-AMD10V	Powerline dimmer actuator 1-10 V	Art. No. 31100006	122,80 €/pc.
------------------	----------------------------------	--------------------------	---------------------

DECENTRALISED TLZ ACTUATOR WITH SENSOR INPUT 230 V PL-SAMILT AND DECENTRALISED ACTUATOR WITH SENSOR INPUT 230 V PL-SMIL



Manuals and documents in further languages:
<http://eltako.com/redirect/PL-SAMILT>

PC software SIENNA-Professional
page 4-9.

Typical connections on page 4-10.



Manuals and documents in further languages:
<http://eltako.com/redirect/PL-SMIL>

PC software SIENNA-Professional
page 4-9.

Typical connections on page 4-10.

PL-SAMILT

Powerline TLZ (staircase time switch) actuator with 1 channel. 53 x 43 mm, 25 mm deep for mounting in 58 mm switch boxes. Off delay settable from 1 minute to 120 minutes. Switch-off early warning settable. 1 NO contact not potential free 10 A/250 V AC, incandescent lamps 2000 watts. Sensor input 230 V. Standby loss only 0,5 watt. To control and switch at the same place.

Two rotary switches are located on the front for address assignment:

The left rotary switch defines the group address g with 16 alphabetical values from A to P.

The right rotary switch determines the off-delay time.

Above it is a slide switch which acts **as a configuration switch with positions 0, 1 and 2.**

Position 0: Pushbutton at sensor input with subsequent switching.

Position 1: Same as Position 0 but with switch-off early warning.

Position 2: A change-over switch is evaluated as a pushbutton.

All entries and configurations can also be accessed via the mains using the PC software SIENNA Professional (see page 4-9).

To the left of the rotary switches is a red LED which indicates all activities.

Next to it is a reset pushbutton and to the right of that is a service pin. For functions, please refer to the operating instructions.

The terminals located above are plug-in terminals for conductor cross-sections of 0.2 mm² to 1.5 mm².

PL-SAMILT	Powerline TLZ actuator 1 channel with sensor input 230 V	Art. No. 31100004	115,30 €/pc.
------------------	--	--------------------------	---------------------

PL-SMIL



Powerline sensor input with 1 channel. 53 x 43 mm, 25 mm deep for mounting in 58 mm switch boxes. Sensor input 230 V. Standby loss only 0,5 watt. To control and switch at different places.

When pressed, the sensor input acts on all actuators with the same address or as a central pushbutton if element address 0 is used.

Two rotary switches are located on the front for address assignment:

The left rotary switch defines the group address g with 16 alphabetical values from A to P.

The right rotary switch defines the element address e with 16 numerical values from 0 to 15.

Above it is a slide switch which acts **as a configuration switch with positions 0, 1 and 2.**

Position 0: Sensor input with reset function as pushbutton.

Position 1: Sensor input functions as NO contact.

Position 2: A change-over switch is evaluated as a pushbutton.

All entries and configurations can also be accessed via the mains using the PC software SIENNA Professional (see page 4-9).

To the left of the rotary switches is a red LED which indicates all activities.

Next to it is a reset pushbutton and to the right of that is a service pin. For functions, please refer to the operating instructions.

The terminals located above are plug-in terminals for conductor cross-sections of 0.2 mm² to 1.5 mm².

PL-SMIL	Powerline sensor input 230 V	Art. No. 31100007	109,20 €/pc.
----------------	------------------------------	--------------------------	---------------------

DECENTRALISED 8-CHANNEL SENSOR INPUT PL-SM8 AND TEMPERATURE CONTROLLER PL-SAMTEMP FOR HEATING AND COOLING



4-8



Manuals and documents in further languages:
<http://eltako.com/redirect/PL-SM8>

PC software SIENNA-Professional
 page 4-9.

Typical connections on page 4-10.



Manuals and documents in further languages:
<http://eltako.com/redirect/PL-SAMTEMP>

PL-SM8



Powerline sensor input with 8 channels. 53 x 43 mm, 25 mm deep for mounting in 58 mm switch boxes. 8 sensor inputs with internal low voltage. Standby loss only 0,5 watt. To control and switch at different places.

Use only potential free switching elements. Internal low voltage applied to the sensor inputs. Two rotary switches are located on the front for address assignment:

The left rotary switch defines the group address g with 16 alphabetical values from A to P.

The right rotary switch defines the element address e with 16 numerical values from 0 to 15.

Above them is a slide switch which functions **as a configuration switch**.

Position 0: 2 adjacent inputs as direction pushbuttons for UP/DOWN or ON/OFF.

Position 1: All sensor inputs function separately as NO contacts.

Position 2: All sensor inputs function separately as pushbuttons.

This setting always affects all 8 inputs. The setting can only be changed after a reset.

To the left of the rotary switches is a red LED which indicates all activities.

Next to it is a reset pushbutton and to the right of that is a service pin. For functions, please refer to the operating instructions.

The terminals located above are plug-in terminals for conductor cross-sections of 0.2 mm² to 1.5 mm².

The addresses of the 8 inputs can also be freely assigned if necessary using the PC software **SIENNA-Professional**.

The socket strip located above this has 9 plug-in wires with wire end-sleeves.

8 control inputs with internal low voltage.

PL-SM8	Powerline sensor inputs, 8 channels, internal low voltage	Art. No. 31800001	115,30 €/pc.
---------------	---	--------------------------	---------------------

PL-SAMTEMP



Powerline temperature controller with display, white, 55 x 55 mm, for mounting in switch systems. In addition a floating control contact 3 A/250 V AC for direct connection of heaters and coolers. Standby loss only 0,4 watt.

The scope of supply comprises a frame R1E and an intermediate frame ZR65/55 for the E-Design, the temperature controller upper part and a bottom part for attachment in 55 mm flush-mounted boxes. The complete display can be removed from the frame for screw mounting.

In normal mode the current room temperature is indicated in the display as well as icons for 'present' or 'absent' and for 'heating on' or 'cooling active'.

Press the pushbuttons (absent) and (present) to activate the associated setpoint.

In setup mode as described in the user's manual, press pushbuttons and to display the setpoint and actual temperatures and change the setpoints.

Control heating or cooling with Powerline actuators SAM1L, SAM2L or the thermostat outputs.

In addition to heating/cooling, a PWM mode for underfloor heating can be set.

All settings can also be made via **SIENNA Professional**.

PL-SAMTEMP	Powerline Temperature controller for heating and cooling	Art. No. 31000010	217,30 €/pc.
-------------------	--	--------------------------	---------------------



Manuals and documents in further languages:
<http://eltako.com/redirect/PL-SW-PROF>



PL-SW-PROF



Coupling element with USB cable and 230 V power pack for connecting a computer to the Powerline network.

The 'SIENNA® Professional' PC software for installing and configuring the Powerline devices from the PC is available for download at eltako.com.

'SIENNA® Professional' is a Windows-based program for installing and configuring all PL and SIENNA components and is designed for electricians.

The Powerline system can be installed and configured either with a screwdriver or a PC. All configuration changes can be made from the PC.

Existing installations in a building can also be read out and recorded.

The bus is coupled via a USB port on the PC. Thanks to Powerline technology, the nearest socket can be used for bus connection.

Download according to the included installation instructions.

4-9

SYSTEM REQUIREMENTS, LAPTOP / PC

Processor	Intel® Pentium® III 366 MHz oder höher
Operating system	Server 2003, Windows XP, Vista (32 Bit), Windows 7 (32 Bit), Windows 8 (32 Bit und 64 Bit), Windows 10
Programming environment	Microsoft .NET Framework 3.5 SP1 or higher
Hard disc memory	32 MB free space on hard disc
RAM memory	128 MB RAM
Screen resolution	1024 x 768
Interface	USB 1.1, 2.0 or 3.0

TECHNICAL DATA ECHELON COUPLING ELEMENT PL-20

Technology	Powerline communication on B/C tape (5 Kb/s); acc. to FCC, CENELEC EN50065-1 and LONWORKS® protocol
Bus coupler	Fused safety socket, 230 V~/50 Hz
PC coupler	USB 1.1 or 2.0
Current draw	Mains plug/power supply unit: maximum 250 mA at 18 V DC voltage. USB: maximum 50 mA at 5 V DC voltage
Processor type	Neuron processor integrated in Powerline Smart Transceiver PL 3120
Temperature range	-25°C to +70°C

PL-SW-PROF	Software PL-SW-PROF	Art. No. 31000020	399,20 €/pc.*
------------	---------------------	-------------------	---------------



Manuals and documents in further languages:
<http://eltako.com/redirect/NF2A>

NF2A



The mains filter up to 2 A 230 V/50 Hz is designed as a built-in filter. It attenuates interference signals from the consumer to the actuator and prevents that disturbances from the connected consumers are reaching the house network. Frequency range 110-140 kHz.

For installation mounting. 49 mm long, 32 mm wide, 24 mm deep.

NF2A	Mains filter up to 2 A, 230 V/50 Hz	Art. No. 30000028	38,10 €/pc.
------	-------------------------------------	-------------------	-------------

TYPICAL CONNECTIONS

4-10

Typical connection PL-SAM1L Additional switching point for an existing consumer

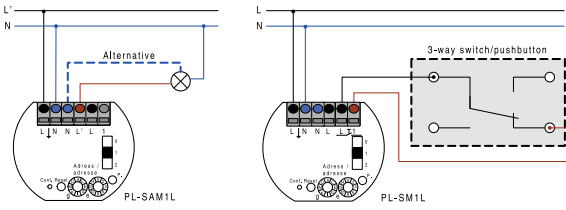

Typical connection PL-SAM2

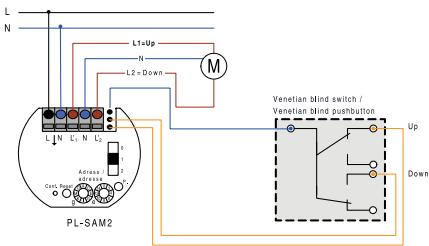

Typical connection PL-AMD10V

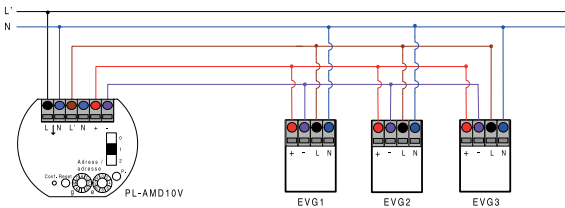

Typical connection PL-SAM1LT Delayed switch-off

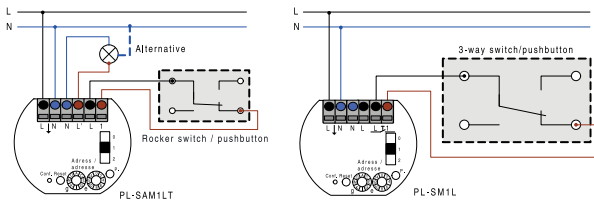

(e.g. staircase time switch or circulation pump)
SAM1LT switches itself and associated actuators off after a preset time.

Typical connection PL-SAM2L

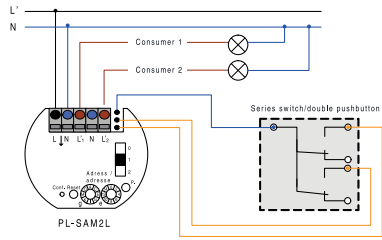

Typical connection PL-SM1 Switch an additional consumer

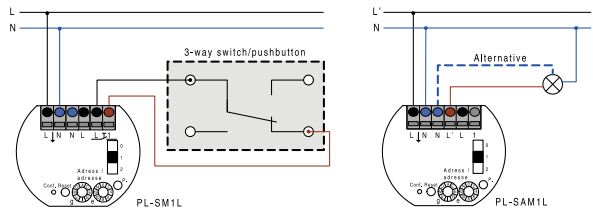

(e.g. mirror light in bathroom, socket in living room, outside light)

Typical connection PL-SM8

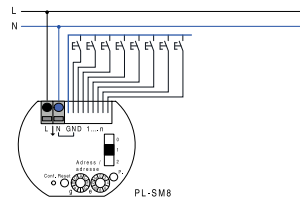

Typical connection PL-SAMDU

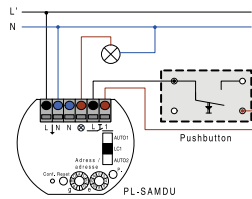

Type	PL-SAMDU	PL-AMD10V	PL-SAM1L PL-SAM1LT	PL-SAM2L	PL-SAM2
Contacts					
Contact material/contact gap	Power Mosfet	AgSnO ₂ /0.5 mm	AgSnO ₂ /0.5 mm	AgSnO ₂ /0,5 mm	AgSnO ₂ /0,5 mm
Spacing of control connections/contact	-	-	3 mm	3 mm	3 mm
Test voltage control connections/contact	-	-	2000 V	2000 V	2000 V
Rated switching capacity each contact	-	600 VA ⁴⁾	10 A/250 V AC	5 A/250 V AC	3 A/250 V AC
Incandescent lamp and halogen lamp load ¹⁾ 230 V, I on ≤ 70 A/10 ms	up to 300 W ²⁾	-	2000 W	1000 W	-
Inductive load cos φ = 0.6/230 V AC inrush current ≤ 35 A	up to 300 W ⁶⁾	-	650 W	650 W ⁵⁾	650 W ⁵⁾
Fluorescent lamp load with KVG* in lead-lag circuit or non compensated	-	-	1000 VA	500 VA	-
Fluorescent lamp load with KVG* shunt-compensated or with EVG*	-	600 VA ⁴⁾	500 VA	250 VA	-
Compact fluorescent lamps with EVG* and energy saving lamps	-	-	up to 400 W	-	-
Dimmable 230 V LED lamps	up to 300 W ³⁾	-	up to 400 W	-	-
Service life at rated load, cos φ = 1 or incandescent lamps 500 W at 100/h	-	>10 ⁵	>10 ⁵	>10 ⁵	>10 ⁵
Service life at rated load, cos φ = 0.6 at 100/h	-	>4x10 ⁴	>4x10 ⁴	>4x10 ⁴	>4x10 ⁴
Max. operating cycles	-	10 ³ /h	10 ³ /h	10 ³ /h	10 ³ /h
Connection type	Plug-in terminals	Plug-in terminals	Plug-in terminals	Plug-in terminals	Plug-in terminals
Minimum conductor cross-section	0.2 mm ²	0.2 mm ²	0.2 mm ²	0.2 mm ²	0.2 mm ²
Maximum conductor cross-section	1.5 mm ²	1.5 mm ²	1.5 mm ²	1.5 mm ²	1.5 mm ²
Conductor stripping	8-9 mm	8-9 mm	8-9 mm	8-9 mm	8-9 mm
Type of enclosure/terminals	IP30/IP20	IP30/IP20	IP30/IP20	IP30/IP20	IP30/IP20
Electronics					
Time on	100%	100%	100%	100%	100%
Max./min. temperature at mounting location	+50°C/-20°C	+50°C/-20°C	+50°C/-20°C	+50°C/-20°C	+50°C/-20°C
Standby loss (active power)	0.6 W	0.5 W	0.5 W	0.5 W	0.5 W
Local control current at 230 V control input	0.4 mA	-	0.4 mA	0.4 mA	0.4 mA
Max. parallel capacitance (approx. length) of local control lead at 230 V AC	3 nF (10 m)	-	3 nF (10 m)	3 nF (10 m)	3 nF (10 m)

¹⁾ Applies to lamps of max. 150 W.
²⁾ Also transformers electronically (C load).
³⁾ Generally applies to 230 V LED lamps. Due to different lamp electronics, switch on/off problems and a restriction in the maximum number of lamps, however, the dimming ranges may be limited depending on the manufacturer; in particular when the connected load is very low (e.g. with 5 W LEDs). The comfort position LC1 at SAMDU optimizes the dimming range, which however results in a maximum capacity of only up to 150 W. In this comfort position, no wound (inductive) transformers should be dimmed.
⁴⁾ Fluorescent lamps or LV halogen lamps with electronic ballast.
⁵⁾ All actuators with 2 contacts: Inductive load cos φ = 0.6 as sum of both contacts 1000 W max.
⁶⁾ A maximum of 2 transformers of the same type.
 * EVG = electronic ballast units; KVG = conventional ballast units

Powerline communication in the B/C-Band (5kb/s) corresponds to FCC, CENELEC EN 50065-1 and LONWORKS protocol

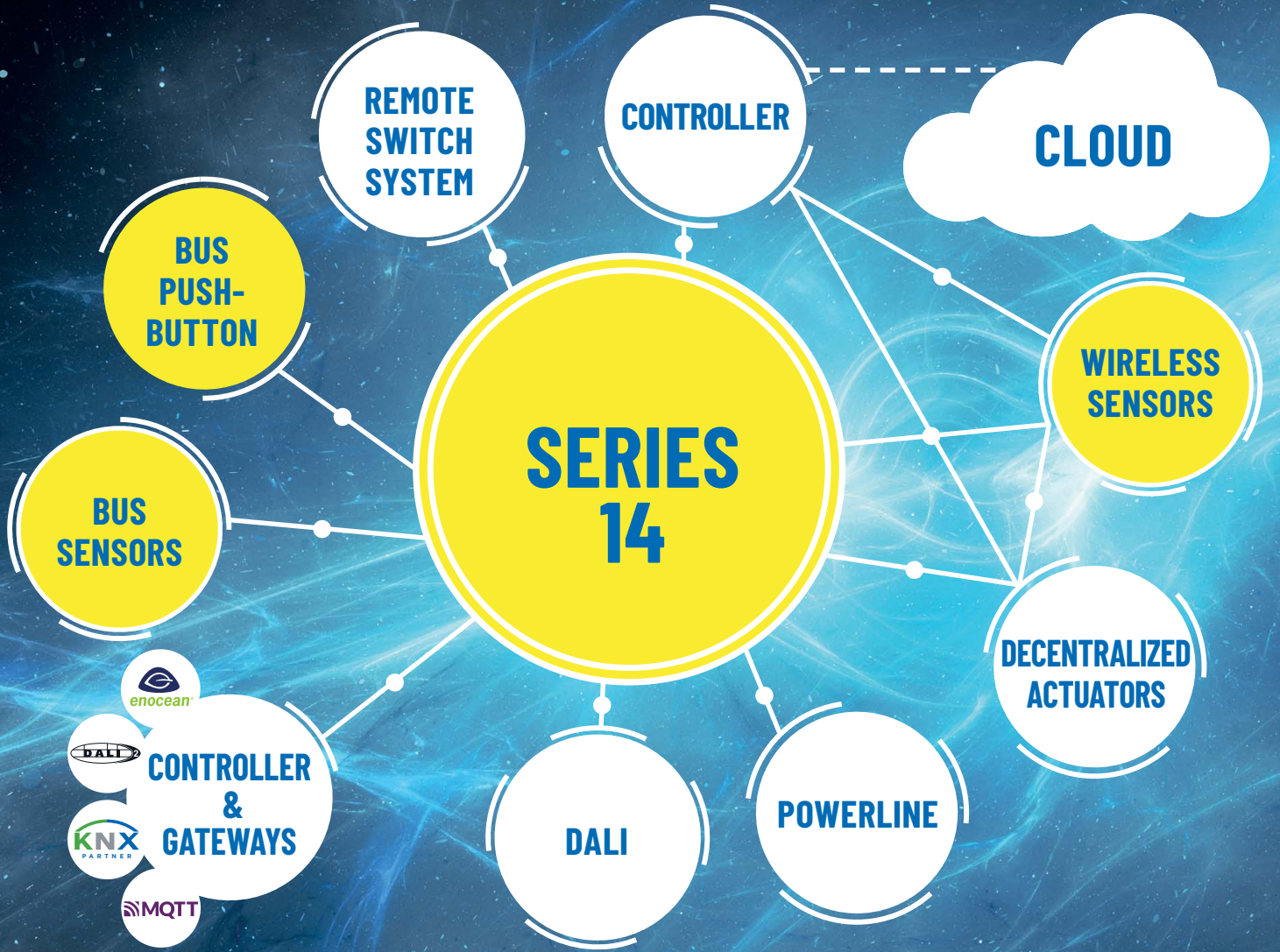

DSS55E+
USBA+C
F1T55E
FTAF55ED

5

**PUSHBUTTON AND SWITCH RANGES
 MOTION SENSORS, WINDOW/DOOR CONTACTS,
 TEMPERATURE- AND OTHER SENSORS**

The Eltako sensor range

Sensors, frames, German sockets (Type F) and covers for E-Design55 and 55 mm switching system	5-2
E-Design55 wireless pushbuttons	5-3
E-Design55 wireless sensors and accessoires	5-6
E-Design55 wireless sensors	5-7
E-Design55 wireless sensors and wireless antenna	5-9
E-Design55 sensors FTS14TG	5-10
E-Design55 sensors BGW14	5-12
E-Design55 conventional pushbuttons / switches	5-13
E-Design55 German sockets (TypE F)	5-14
E-Design55 covers	5-15
E-Design55 frames	5-17
E-Design55 accessoires	5-19
55 mm switching system wireless pushbuttons and wireless switches	5-20
55 mm switching system conventional pushbuttons / switches	5-21
55 mm switching system German sockets (TypE F)/covers	5-22
Compatible sensors wireless pushbuttons	5-23
Compatible sensors wireless pushbuttons and accessoires	5-26
Compatible sensors Friends of Hue sensors / Bluetooth wireless pushbutton insert	5-27
Remote controls and further sensors hand-held transmitters	5-28
Remote controls and further sensors other sensors	5-31
Other Wireless small actuator Smart Valve FKS-SV and multi sensor MS	5-40
Rockers and double rockers E-Design55 laser engraved	5-41
Rockers and double rockers laser-engraved for pushbuttons, switches, remote controls and handheld transmitters	5-42
Overview pictograms for laser engravings	5-44

SENSORS, FRAMES, GERMAN SOCKETS (TYPE F) AND BLIND COVERS FOR E-DESIGN55 AND 55 MM SWITCH SYSTEM

A complete range of sensors from a single source in attractive designs.

Eltako supplies a modern program in several appealing designs, from battery-free and wireless EnOcean wireless sensors to bus buttons and wired sensors.

It goes without saying that frames are part of this range, along with a wide variety of covers and German sockets (Type F) with matching tops.

The success of the classic style of the 55 mm switch system was followed by its logical continuation – the E-Design55 (80x80 mm) in new and established colours.

Frames 80 x 80 mm, pushbutton 55 x 55 mm

Colours

-am
(similar to RAL 7016)
anthracite mat

-pg
(similar to RAL 9010)
polar white glossy

-pm
(similar to RAL 9010)
polar white mat

-wg
(similar to RAL 9016)
pure white glossy



15 mm high

55 mm switch system

Frames 80 x 80 mm, pushbutton 55 x 55 mm

Colours

-an
anthracite

-al
coated/aluminium paint

-rw
pure white

-wg
pure white glossy

-ws
white



15 mm high

Type	Color	Art. No.	€/pc.
------	-------	----------	-------



Wireless pushbutton with rocker



More informations:



<http://eltako.com/redirect/F1T55E->

F1T55E-



Wireless 1-way pushbutton in E-Design55

Wireless 1-way pushbutton in E-Design55, 80x80 mm external dimensions, internal frame dimensions 55x55 mm, 15 mm high. Generates the power for wireless telegrams itself when the button is pressed, therefore there is no connecting wire and no standby loss.

Wireless pushbuttons with one rocker can send an analysable signal. Press the bottom of the rocker near the mark.

The mounting plate can be screwed over a flush-mounting box with a screw spacing of 60 mm or screwed on a flat surface.

The wireless pushbutton can be glued to the wall, on glass or on furniture using the enclosed adhesive foil.

F1T55E-am	anthracite mat	30055702	49,40
F1T55E-pg	polar white glossy	30055703	49,40
F1T55E-pm	polar white mat	30055713	49,40
F1T55E-wg	pure white glossy	30055725	49,40

Type	Color	Art. No.	€/pc.
------	-------	----------	-------



Wireless pushbutton with rocker



More informations:



<http://eltako.com/redirect/F2T55E->

F2T55E-



Wireless 2-way pushbutton in E-Design55

Wireless 2-way pushbutton in E-Design55, 80x80 mm external dimensions, internal frame dimensions 55x55 mm, 15 mm high. Generates the power for wireless telegrams itself when the button is pressed, therefore there is no connecting wire and no standby loss.

Wireless pushbuttons with one rocker can transmit two evaluable signals: press rocker up and press rocker down.

The mounting plate can be screwed over a flush-mounting box with a screw spacing of 60 mm or screwed on a flat surface.

The wireless pushbutton can be glued to the wall, on glass or on furniture using the enclosed adhesive foil.

F2T55E-am	anthracite mat	30055718	53,90
F2T55E-pg	polar white glossy	30055702	53,90
F2T55E-pm	polar white mat	30055727	53,90
F2T55E-wg	pure white glossy	30055715	53,90
F2T55E0R-am	anthracite mat	30056718	51,20
F2T55E0R-pg	polar white glossy	30056702	51,20
F2T55E0R-pm	polar white mat	30056727	51,20
F2T55E0R-wg	pure white glossy	30056715	51,20

OR types without single frames included in the scope of delivery, for mounting in multiple or third-party frames.



Wireless pushbutton with double rocker



More informations:



<http://eltako.com/redirect/F4T55E->

F4T55E-



Wireless 4-way pushbutton in E-Design55

Wireless 4-way pushbutton in E-Design55, 80x80 mm external dimensions, internal frame dimensions 55x55 mm, 15 mm high. Generates the power for wireless telegrams itself when the button is pressed, therefore there is no connecting wire and no standby loss.

Wireless pushbuttons with double rocker can transmit four evaluable signals: press two rockers up or down. The mounting plate can be screwed over a flush-mounting box with a screw spacing of 60 mm or screwed on a flat surface.

The wireless pushbutton can be glued to the wall, on glass or on furniture using the enclosed adhesive foil.

F4T55E-am	anthracite mat	30055708	55,80
F4T55E-pg	polar white glossy	30055733	55,80
F4T55E-pm	polar white mat	30055734	55,80
F4T55E-wg	pure white glossy	30055705	55,80
F4T55E0R-am	anthracite mat	30056708	51,20
F4T55E0R-pg	polar white glossy	30056733	51,20
F4T55E0R-pm	polar white mat	30056734	51,20
F4T55E0R-wg	pure white glossy	30056705	51,20

OR types without single frames included in the scope of delivery, for mounting in multiple or third-party frames.



Wireless pushbutton with rocker



More informations:



<http://eltako.com/redirect/F2ZT55E->

F2ZT55E-



Wireless 2-way central control pushbutton in E-Design55

Wireless 2-way pushbutton in E-Design55, 80x80 mm external dimensions, internal frame dimensions 55x55 mm, 15 mm high. Generates the power for wireless telegrams itself when the button is pressed, therefore there is no connecting wire and no standby loss. With rocker laser engraved.

Wireless pushbuttons with one rocker can transmit two evaluable signals: press rocker up and press rocker down. Snap the large rocker so that the markings 0 and I on the back line up with the same markings on the wireless module.

The mounting plate can be screwed over a flush-mounting box with a screw spacing of 60 mm or screwed on a flat surface.

The wireless pushbutton can be glued to the wall, on glass or on furniture using the enclosed adhesive foil.

F2ZT55E-al	coated/aluminium paint	30055441	66,50
F2ZT55E-am	anthracite mat	30055442	59,60
F2ZT55E-pg	polar white glossy	30055443	59,60
F2ZT55E-pm	polar white mat	30055445	59,60
F2ZT55E-wg	pure white glossy	30055447	59,60

E-DESIGN55 WIRELESS PUSHBUTTON

Type	Color	Art. No.	€/pc.
------	-------	----------	-------



F4PT55E-



Wireless 4-way profile pushbutton in E-Design55

Wireless 4-way profile pushbutton for single mounting 80 x 80 x 15 mm or mounting in the E-Design55 switching system. Generates the power for wireless telegrams itself when the button is pressed, therefore there is no connecting wire and no standby loss. With double rocker laser engraved with 'Home Day/ Night', 'Away' and 'Holiday' each for profile switching of controllers in the selected language and colour.

8 languages are available:

-de (German); **-fi** (Finnish); **fl** (Flemish); **-fr** (French); **-gb** (English); **-nl** (Dutch); **-se** (Swedish); **-sp** (Spanish). There are also **4 colours**: **-am** (matt anthracite); **-pg** (polar white glossy); **-pm** (polar white mat); **-wg** (pure white glossy).

When ordering, please specify the desired language and colour. **Example** of profile button German in pure white glossy: **F4PT55E-de-wg**.

F4PT55E-		30055432	61,40
-----------------	--	-----------------	--------------

Battery-free
by EnOcean

More informations:



<http://eltako.com/redirect/F4PT55E->

5-4

Type	Color	Art. No.	€/pc.
------	-------	----------	-------



FS55E-



Wireless switch without battery or wire in E-Design55

Wireless switch with rocker

Wireless switch in E-Design55, 80 x 80 mm outside, frame inside dimensions 55 x 55 mm, 15 mm high. Generates the energy for wireless telegrams itself when a button is pressed, so there is no connection cable and no standby loss.

This wireless switch can be taught-in as an 'universal pushbutton' in the impulse switch relays of the series 61, 62 and 14. Press the wireless switch up or down, the switching position of the actuator changes each time it is pressed (toggle). If several wireless switches or wireless pushbuttons are taught in together, the wireless switch fulfills the function of a toggle switch.

Battery-free
by EnOcean



More informations:

<http://eltako.com/redirect/FS55E->

FS55E-am	anthracite mat	30000602	53,90
FS55E-pg	polar white glossy	30055811	53,90
FS55E-pm	polar white mat	30055812	53,90
FS55E-wg	pure white glossy	30000601	53,90



F2T55EB-



Wireless 2-way pushbutton with battery in E-Design55

Wireless pushbutton with rocker

Wireless 2-way pushbutton in E-Design55, 80 x 80 mm external dimensions, internal frame dimensions 55 x 55 mm, 15 mm high. Whisper quiet and with battery (lifetime 2-7 years).

Wireless pushbuttons with one rocker can transmit two evaluable signals: press rocker up and press rocker down.

The mounting plate can be screwed over a flush-mounting box with a screw spacing of 60 mm or screwed on a flat surface.

The wireless pushbutton can be glued to the wall, on glass or on furniture using the enclosed adhesive foil.

F2T55EB-am	anthracite mat	30055676	70,80
F2T55EB-pg	polar white glossy	30055672	70,80
F2T55EB-pm	polar white mat	30055673	70,80
F2T55EB-wg	pure white glossy	30055675	70,80



<http://eltako.com/redirect/F2T55EB->

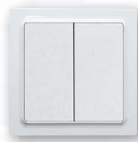

F4T55EB-



Wireless 4-way pushbutton with battery in E-Design55

Wireless pushbutton with double rocker

Wireless 4-way pushbutton in E-Design55, 80 x 80 mm external dimensions, internal frame dimensions 55 x 55 mm, 15 mm high. Whisper quiet and with battery (lifetime 2-7 years).

Wireless pushbuttons with double rocker can transmit four evaluable signals: press two rockers up or down. The mounting plate can be screwed over a flush-mounting box with a screw spacing of 60 mm or screwed on a flat surface.

The wireless pushbutton can be glued to the wall, on glass or on furniture using the enclosed adhesive foil.



<http://eltako.com/redirect/F4T55EB->

F4T55EB-am	anthracite mat	30055688	72,80
F4T55EB-pg	polar white glossy	30055682	72,80
F4T55EB-pm	polar white mat	30055683	72,80
F4T55EB-wg	pure white glossy	30055685	72,80

E-DESIGN55 WIRELESS PUSHBUTTON

Type	Color	Art. No.	€/pc.
------	-------	----------	-------



F6T55EB-



Wireless 6-way pushbutton in E-Design55

Wireless-6-way pushbutton in E-Design55, 80x80 mm external dimensions, internal frame dimensions 55x55 mm, 15 mm high. Whisper quiet and with battery (lifetime 5-8 years).

The wireless 6-way pushbutton can send 6 evaluable pushbutton telegrams. It basically consists of an 'upper 4-channel pushbutton' and a 'lower 2-channel pushbutton'.

The mounting plate can be screwed over a flush-mounting box with a screw spacing of 60 mm or screwed on a flat surface.

The wireless pushbutton can be glued to the wall, on glass or on furniture using the enclosed adhesive foil.

More informations:



<http://eltako.com/redirect/F6T55EB->

F6T55EB-am	anthracite mat	30055696	83,60
F6T55EB-pg	polar white glossy	30055692	83,60
F6T55EB-pm	polar white mat	30055693	83,60
F6T55EB-wg	pure white glossy	30055695	83,60

Type	Color	Art. No.	€/pc.
------	-------	----------	-------



F6T55EB-Keypad-



Wireless 6-way pushbutton as keypad, laser engraved, in E-Design55

Keypad mit Lasergravur

Wireless 6-way pushbutton as keypad, laser engraved, in E-Design55, 80x80 mm external dimensions, internal frame dimensions 55x55 mm, 15 mm high. Whisper quiet and with battery (lifetime 5-8 years). The wireless 6-way pushbutton can send 6 evaluable pushbutton telegrams. It basically consists of an 'upper 4-channel pushbutton' and a 'lower 2-channel pushbutton'.

The mounting plate can be screwed over a flush-mounting box with a screw spacing of 60 mm or screwed on a flat surface.

The wireless pushbutton can be glued to the wall, on glass or on furniture using the enclosed adhesive foil.

More informations:



<http://eltako.com/redirect/F6T55EB-Keypad->

F6T55EB-Keypad-am	anthracite mat	30055149	87,10
F6T55EB-Keypad-pg	polar white glossy	30055150	87,10
F6T55EB-Keypad-pm	polar white mat	30055151	87,10
F6T55EB-Keypad-wg	pure white glossy	30055148	87,10



F1T55E-wg/rot



Wireless 1-way pushbutton in E-Design55 for calling systems

Wireless pushbutton with rocker

Wireless 1-way pushbutton in E-Design55 for calling systems, 80x80 mm external dimensions, internal frame dimensions 55x55 mm, 15 mm high. Generates the power for wireless telegrams itself when the button is pressed, therefore there is no connecting wire and no standby loss.

Wireless pushbuttons with one rocker can send an analysable signal. Press the bottom of the rocker near the mark. The mounting plate can be screwed over a flush-mounting box with a screw spacing of 60 mm or screwed on a flat surface. The wireless pushbutton can be glued to the wall, on glass or on furniture using the enclosed adhesive foil.

Battery-free by EntOcean



More informations:



http://eltako.com/redirect/F1T55E-wg*rot

F1T55E-wg/rot	pure white glossy/red	30055810	64,10
----------------------	-----------------------	-----------------	--------------

E-DESIGN55 WIRELESS SENSORS AND ACCESSOIRES

Type	Color	Art. No.	€/pc.
------	-------	----------	-------



FUTH55ED/230V-

Wireless clock thermo hygrostat with display in E-Design55

Wireless clock thermo hygrostat with display for single mounting 80x80x14 mm or mounting into the E-Design55 switching system. Installation depth 33 mm. With adjustable day and night reference temperatures and reference humidity. Preset ready to operate. Illuminated display. Power supply 230 V. Only 0.5 watt standby loss.

More informations:



http://eltako.com/redirect/FUTH55ED*230V-

FUTH55ED/230V-am	anthracite mat	30055802	105,60
FUTH55ED/230V-pg	polar white glossy	30055803	105,60
FUTH55ED/230V-pm	polar white mat	30055804	105,60
FUTH55ED/230V-wg	pure white glossy	30055805	105,60

Type	Color	Art. No.	€/pc.
------	-------	----------	-------



FUTH55ED/12-24V UC-

Wireless clock thermo hygrostat with display in E-Design55

Wireless clock thermo hygrostat with display for single mounting 80x80x14 mm or mounting into the E-Design55 switching system. Installation depth 33 mm. With adjustable day and night reference temperatures and reference humidity. Preset ready to operate. Illuminated display. Power supply 12-24 V UC. Only 0.3 watt standby loss.

More informations:



http://eltako.com/redirect/FUTH55ED*12-24V UC-

FUTH55ED/12-24V UC-am	anthracite mat	30055798	106,60
FUTH55ED/12-24V UC-pg	polar white glossy	30055799	106,60
FUTH55ED/12-24V UC-pm	polar white mat	30055800	106,60
FUTH55ED/12-24V UC-wg	pure white glossy	30055801	106,60



NFCS55E-

NFC sensor in E-Design55

NFC sensor for single mounting 80x80x15 mm or mounting into the E-Design55 switching system. Without battery or wire. No standby loss. The NFC sensor can be used to trigger smart home functions with the mobile phone and to save data. It does not send its own telegram into the radio network, serves primarily as a 'trigger' and must be actively scanned. In conjunction with smart end devices, this can be integrated into a smart home control system.

More informations:



<http://eltako.com/redirect/NFCS55E->

NFCS55E-am	anthracite mat	30055647	20,00
NFCS55E-pg	polar white glossy	30055648	20,00
NFCS55E-pm	polar white mat	30055649	20,00
NFCS55E-wg	pure white glossy	30055646	20,00



S055

Desktop base for E-Design55

Desktop base for E-Design55 pushbuttons and sensors, except 230 V versions, are clipped onto the base. With slip-resistant plastic feet.

More informations:



<http://eltako.com/redirect/S055>

S055	pure white	30000346	9,10
-------------	------------	-----------------	-------------

E-DESIGN55 WIRELESS SENSORS

Type	Color	Art. No.	€/pc.
------	-------	----------	-------



FTR55ESB-

Wireless temperature controller in E-Design55

Wireless temperature for single mounting 80x80x27 mm or mounting into the E-Design55 switching system. With solar cells and battery (lifetime 5 years).



More informations:



<http://eltako.com/redirect/FTR55ESB->

FTR55ESB-am	anthracite mat	30055790	97,50
FTR55ESB-pg	polar white glossy	30055791	97,50
FTR55ESB-pm	polar white mat	30055792	97,50
FTR55ESB-wg	pure white glossy	30055793	97,50

Type	Color	Art. No.	€/pc.
------	-------	----------	-------



FTR55EHB-

Wireless temperature controller 55 x 55 mm with hand wheel and battery in E-Design55

Wireless temperature controller with hand wheel for single mounting 80x80x27 mm or mounting into the E-design55 switching system. With battery (lifetime 4 years).



More informations:



<http://eltako.com/redirect/FTR55EHB->

FTR55EHB-am	anthracite mat	30055766	88,80
FTR55EHB-pg	polar white glossy	30055767	88,80
FTR55EHB-pm	polar white mat	30055768	88,80
FTR55EHB-wg	pure white glossy	30055769	88,80



FTAF55ED/230V-

Wireless temperature controller Air+Floor in E-Design55

Wireless temperature controller Air+Floor with display for single mounting 80x80x14 mm or mounting into the E-Design55 switching system. Installation depth 33 mm.



With adjustable day and night reference temperatures. Display illuminated. Preset ready to operate. Wired temperature sensor for monitoring of floor temperature can be connected. 1 NO contact not potentialfree 16 A/250 V AC. Power supply 230 V. Only 0.4 watt standby loss.

More informations:



<http://eltako.com/redirect/FTAF55ED/230V->

FTAF55ED/230V-am	anthracite mat	30055794	103,10
FTAF55ED/ 230V-pg	polar white glossy	30055795	103,10
FTAF55ED/230V-pm	polar white mat	30055796	103,10
FTAF55ED/ 230V-wg	pure white glossy	30055797	103,10



FFT55EB-

Wireless humidity temperature sensor in E-Design55

Wireless humidity temperature sensor for single mounting 80x80x17 mm or mounting into the E-Design55 switching system. With battery (lifetime 5 years).



More informations:



<http://eltako.com/redirect/FFT55EB->

FFT55EB-am	anthracite mat	30055476	75,00
FFT55EB-pg	polar white glossy	30055477	75,00
FFT55EB-pm	polar white mat	30055478	75,00
FFT55EB-wg	pure white glossy	30055475	75,00

Type	Color	Art. No.	€/pc.
------	-------	----------	-------



FLGTF55E/230V-



Wireless air quality+temperature+humidity sensor in E-Design55

Wireless air quality+temperature+humidity sensor for single mounting 80 x 80 x 17/33 mm or mounting into the E-Design55 switching system. With LED display to signal room air quality. With additional alert tone. Power supply 230 V. Stand-by loss only 0.6 watt.



More informations:



http://eltako.com/redirect/FLGTF55E*230V-

FLGTF55E/230V-am	anthracite mat	30055521	105,10
FLGTF55E/230V-pg	polar white glossy	30055522	105,10
FLGTF55E/230V-pm	polar white mat	30055523	105,10
FLGTF55E/230V-wg	pure white glossy	30055520	105,10

Type	Color	Art. No.	€/pc.
------	-------	----------	-------



FBH55ESB-



Wireless motion/brightness sensor in E-Design55

Wireless motion/brightness sensor for single mounting 80 x 80 x 27 mm or mounting into the E-Design55 switching system. With solar cells and battery (lifetime 4-5 years).



More informations:



<http://eltako.com/redirect/FBH55ESB->

FBH55ESB-am	anthracite mat	30055516	106,80
FBH55ESB-pg	polar white glossy	30055517	106,80
FBH55ESB-pm	polar white mat	30055518	106,80
FBH55ESB-wg	pure white glossy	30000514	106,80



FB55EB-



Wireless motion sensor in E-Design55

Wireless motion sensor for surface mounting 80 x 80 x 27 mm or mounting into the E-Design55 switching system. With battery (lifetime 3 years).



More informations:



<http://eltako.com/redirect/FB55EB->

FB55EB-am	anthracite mat	30055513	89,10
FB55EB-pg	polar white glossy	30055514	89,10
FB55EB-pm	polar white mat	30055515	89,10
FB55EB-wg	pure white glossy	30055512	89,10



FMS55ESB-



Wireless multi sensor in E-Design55

Wireless multi sensor for single mounting 80 x 80 x 14 mm or mounting into the E-Design55 switching system. With integrated solar cell and battery CR 1632 (not included in the scope of supply).



More informations:



<http://eltako.com/redirect/FMS55ESB->

FMS55ESB-am	anthracite mat	30055763	115,40
FMS55ESB-pg	polar white glossy	30055764	115,40
FMS55ESB-pm	polar white mat	30055765	115,40
FMS55ESB-wg	pure white glossy	30055561	115,40

E-DESIGN55 WIRELESS SENSORS AND WIRELESS ANTENNA

Type	Color	Art. No.	€/pc.
------	-------	----------	-------



FSU55ED/230V-



Wireless timer with display in E-Design55

Wireless timer with display and with 8 channels for single mounting 80 x 80 x 14 mm or mounting into the E-Design55 switching system. Installation depth 33 mm. With 'astro' function and solstice time changes. Illuminated display. Power supply 230 V. Only 0.5 watt standby loss.



More informations:



<http://eltako.com/redirect/FSU55ED/230V->

FSU55ED/230V-am	anthracite mat	30055806	99,40
FSU55ED/230V-pg	polar white glossy	30055807	99,40
FSU55ED/230V-pm	polar white mat	30055808	99,40
FSU55ED/230V-wg	pure white glossy	30055809	99,40

Type	Color	Art. No.	€/pc.
------	-------	----------	-------



FAG55E-



Wireless antenna in the housing for single mounting 80 x 80 x 15 mm or mounting into the E-Design55 switching system. With 100 cm cable.

The mounting plate can be screwed over a flush-mounting box with a screw spacing of 60 mm. In the housing there is a wireless antenna with ground plane and permanently attached antenna cable, 100 cm long, with SMA screw.



More informations:



<http://eltako.com/redirect/FAG55E->

FAG55E-am	anthracite mat	30055144	48,80
FAG55E-pg	polar white glossy	30055145	48,80
FAG55E-pm	polar white mat	30055146	48,80
FAG55E-wg	pure white glossy	30055147	48,80

E-DESIGN55 SENSORS FOR FTS14TG

Type	Color	Art. No.	€/pc.
------	-------	----------	-------



Bus pushbutton with rocker

B4T55E-

Bus 2- or 4-way pushbutton for single mounting or mounting into the E-Design55 switching system. 80 x 80 mm, 15 mm high. For connection to FTS14TG pushbutton gateway. Only 0.2 watt standby loss.



Bus pushbutton with double rocker

The scope of supply comprises a mounting base, an attachment frame with snapped-on electronics, a frame, a rocker and a double rocker. The double rocker permits entry of 4 evaluable signals, but the rocker allows only 2 signals. At the rear, a 20 cm long red/black bus line is routed externally. Red terminal to BP, black to BN of a pushbutton gateway FTS14TG.



More informations:



<http://eltako.com/redirect/B4T55E->

B4T55E-am	anthracite mat	30055650	59,80
B4T55E-pg	polar white glossy	30055651	59,80
B4T55E-pm	polar white mat	30055652	59,80
B4T55E-wg	pure white glossy	30055653	59,80

FTS61BTKL



Bus pushbutton coupler FTS61BTKL for 4 conventional pushbuttons with integrated 24 V LEDs for connection to FTS14TG pushbutton gateways by 2-wire pushbutton bus. Only 0.2 watt standby loss.

For installation. 45 mm long, 45 mm wide, 18 mm deep. Up to 30 bus pushbuttons and/or bus pushbutton couplers FTS61BTKL devices can be connected to the BP and BN terminals of a pushbutton gateway FTS14TG. The permitted total line length is 200 m. The RLC device enclosed with the FTS14TG must also be connected to the terminals BP and BN on the bus switch or pushbutton bus coupler furthest away. A voltage of 29 V DC is supplied to the connected FTS61BTKL over a 2-wire pushbutton bus which is also used for data transfer. Please use only conventional bus or telephone lines. Up to four conventional pushbuttons T1-T4 can be connected to the 15 cm long connecting cables. Each opposite pole is T0. The connecting cables can be extended up to 2 m. With the 24 V LEDs integrated in the pushbuttons, confirmation telegrams of actuators are displayed if the IDs of the actuators were registered into the ID table of the FTS14TG with PCT14.

Caution: Do not apply any voltage.

The pairs T1/T3 and T2/T4 can be defined as direction pushbuttons. Connect the bus to BP and BN. Make sure the polarity is correct!

Type	Color	Art. No.	€/pc.
------	-------	----------	-------



FTS61BTK



Bus pushbutton coupler FTS61BTK for 4 conventional pushbuttons for connection to FTS14TG pushbutton gateways by 2-wire pushbutton bus. Only 0.2 watt standby loss.

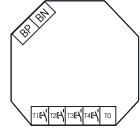

For installation. 45 mm long, 45 mm wide, 18 mm deep. Up to 30 bus pushbuttons and/or bus pushbutton couplers FTS61BTK devices can be connected to the BP and BN terminals of a pushbutton gateway FTS14TG. The permitted total line length is 200 m. The RLC device enclosed with the FTS14TG must also be connected to the terminals BP and BN on the bus switch or pushbutton bus coupler furthest away. A voltage of 29 V DC is supplied to the connected FTS61BTK over a 2-wire pushbutton bus which is also used for data transfer.

Up to four conventional pushbuttons can be connected to T1, T2, T3 and T4 by a maximum line length of 2 metres. Connect the opposite pole to the T0 terminal in each case.

Caution: Do not apply any voltage.

The pairs T1/T3 and T2/T4 can be defined as direction pushbuttons.

Connect the bus to BP and BN. Make sure the polarity is correct!

More informations:



<http://eltako.com/redirect/FTS61BTK>

FTS61BTK	blue	30014064	57,10
-----------------	------	-----------------	--------------

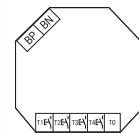

More informations:



<http://eltako.com/redirect/FTS61BTKL>

FTS61BTKL	blue	30014074	62,50
------------------	------	-----------------	--------------

Type	Color	Art. No.	€/pc.
------	-------	----------	-------

FTS61BTK/8



Bus pushbutton coupler FTS61BTK/8 for 8 conventional pushbuttons for connection to FTS14TG pushbutton gateways by 2-wire pushbutton bus. Only 0.2 watt standby loss.

For installation. 45 mm long, 45 mm wide, 18 mm deep. Up to 30 bus pushbuttons and/or bus pushbutton couplers FTS61BTK/8 devices can be connected to the BP and BN terminals of a pushbutton gateway FTS14TG. The permitted total line length is 200 m. The RLC device enclosed with the FTS14TG must also be connected to the terminals BP and BN on the bus switch or pushbutton bus coupler furthest away.

A voltage of 29 V DC is supplied to the connected FTS61BTK/8 over a 2-wire pushbutton bus which is also used for data transfer.

Please use only conventional bus or telephone lines.

Up to eight conventional pushbuttons T1-T8 can be connected to the 15 cm long connecting cables. Each opposite pole is T0. The connecting cables can be extended up to 2 m.

Caution: Do not apply any voltage.

Type	Color	Art. No.	€/pc.
------	-------	----------	-------

The pairs T1/T3, T2/T4, T5/T7 and T6/T8 can be defined as direction pushbuttons.

Connect the bus to BP and BN. Make sure the polarity is correct!

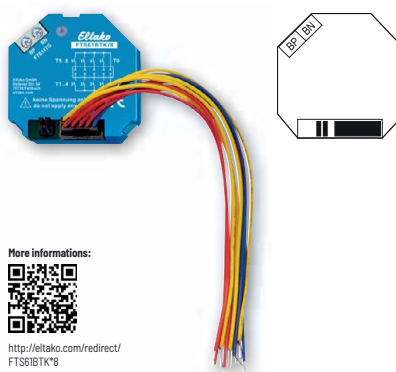

More informations:



http://eltako.com/redirect/FTS61BTK*8

FTS61BTK/8	blue	30014075	93,50
-------------------	------	-----------------	--------------

5-11

E-DESIGN55 SENSORS FOR BGW14

Type	Color	Art. No.	€/pc.
------	-------	----------	-------



BBH55E/12V DC-



Bus motion/brightness sensor in E-Design55.

Bus motion/brightness sensor for connection to the RS485 bus gateway BGW14. For single mounting or mounting into the E-Design55 switching system. 80x80 mm, 25 mm high. Installation depth 33 mm. Data transmission and power supply take place over the 4-wire bus with a 12 V DC switching power supply unit. Only 0.1 watt standby loss.

More informations:



http://eltako.com/redirect/BBH55E*12V_DC-

BBH55E/12V DC-am	anthracite mat	30055152	78,20
BBH55E/12V DC-pg	polar white glossy	30055153	78,20
BBH55E/12V DC-pm	polar white mat	30055154	78,20
BBH55/12V DC-wg	pure white glossy	30055155	78,20

Type	Color	Art. No.	€/pc.
------	-------	----------	-------



BUTH55ED/12V DC-



Bus thermo clock/hygrostat with display in E-Design55

Bus thermo clock/hygrostat with display pure white glossy for connection to the RS485 bus gateway BGW14. For single mounting or mounting into the E-Design55 switching system. 80x80 mm, 14 mm high. Installation depth 33 mm. With adjustable day and night reference temperatures and relative humidity. Illuminated display. Preset ready to operate. Data transmission and power supply takes place over the 4-wire bus with a 12 V DC power supply unit. Only 0.1 watt standby loss.

More informations:



http://eltako.com/redirect/BUTH55ED*12V_DC-

BUTH55ED/12V DC-am	anthracite mat	30055164	91,80
BUTH55ED/12V DC-pg	polar white glossy	30055165	91,80
BUTH55ED/12V DC-pm	polar white mat	30055166	91,80
BUTH55ED/12V DC-wg	pure white glossy	30055167	91,80



BTR55EH/12V DC-



Bus temperature controller with hand wheel in E-Design55

Bus temperature controller with hand wheel for connection to the RS485 bus gateway BGW14. For single mounting or mounting into the E-Design55 switching system. 80x80 mm, 27 mm high. Installation depth 33 mm. Data transmission and power supply take place over the 4-wire bus with a 12 V DC switching power supply unit. Only 0.1 watt standby loss.

More informations:



http://eltako.com/redirect/BTR55EH*12V_DC-

BTR55EH/12V DC-am	anthracite mat	30055160	72,70
BTR55EH/12V DC-pg	polar white glossy	30055161	72,70
BTR55EH/12V DC-pm	polar white mat	30055162	72,70
BTR55EH/12V DC-wg	pure white glossy	30055163	72,70



BTF55E/12V DC-



Bus temperature sensor in E-Design55

Bus temperature sensor pure white glossy for connection to the RS485 bus gateway BGW14. For single mounting or mounting into the E-Design55 switching system. 80x80 mm, 17 mm high. Installation depth 33 mm. Data transmission and power supply take place over the 4-wire bus with a 12 V DC mains adapter. Only 0.1 watt standby loss.

More informations:



http://eltako.com/redirect/BTF55E*12V_DC-

BTF55E/12V DC-am	anthracite mat	30055156	66,80
BTF55/12V DC-pg	polar white glossy	30055157	66,80
BTF55/12V DC-pm	polar white mat	30055158	66,80
BTF55/12V DC-wg	pure white glossy	30055159	66,80

E-DESIGN55 CONVENTIONAL PUSHBUTTONS / SWITCHES

Type	Color	Art. No.	€/pc.
------	-------	----------	-------



WT55E-

Rocker pushbutton in E-Design55

Rocker pushbutton, 1 NO contact 10 A/250 V AC. Pushbutton for single mounting 80 x 80 x 18 mm or mounting into the E-Design55 switching system. The rocker pushbutton with VDE sign has plug-in terminals.

As an alternative to claw attachment, screw attachment is possible on a mounting box with a screw spacing of 60 mm with stainless steel countersunk screws 2.9 x 25 mm, DIN 7982 C.

Installation: Fit rocker pushbutton, fix frame using attachment frame and plug on rocker.



More informations:



<http://eltako.com/redirect/WT55E->

WT55E-am	anthracite mat	30055742	15,20
WT55E-pg	polar white glossy	30055743	15,20
WT55E-pm	polar white mat	30055744	15,20
WT55E-wg	pure white glossy	30055709	15,20

Type	Color	Art. No.	€/pc.
------	-------	----------	-------



W2T55E-

Rocker pushbutton with double rocker in E-Design55

Rocker pushbutton with double rocker, 2 NO contacts 10 A/250 V AC. Pushbutton for single mounting 80 x 80 x 18 mm or mounting into the E-Design55 switching system.

The rocker pushbutton with VDE sign has plug-in terminals.

As an alternative to claw attachment, screw attachment is possible on a mounting box with a screw spacing of 60 mm with stainless steel countersunk screws 2.9 x 25 mm, DIN 7982 C.

Installation: Fit rocker pushbutton, fix frame using attachment frame and plug on rocker.



More informations:



<http://eltako.com/redirect/W2T55E->

W2T55E-am	anthracite mat	30055745	18,10
W2T55E-pg	polar white glossy	30055752	18,10
W2T55E-pm	polar white mat	30055762	18,10
W2T55E-wg	pure white glossy	30055712	18,10



WS55E-

Rocker switch in E-Design55

Rocker switch, 1 CO contact 10 A/250 V AC. Switch for single mounting 80 x 80 x 18 mm or mounting into the E-Design55 switching system.

The rocker switch with VDE sign has plug-in terminals.

As an alternative to claw attachment, screw attachment is possible on a mounting box with a screw spacing of 60 mm with stainless steel countersunk screws 2.9 x 25 mm, DIN 7982 C.

Installation: Fit rocker pushbutton, fix frame using attachment frame and plug on rocker.



More informations:



<http://eltako.com/redirect/WS55E->

WS55E-am	anthracite mat	30055735	14,50
WS55E-pg	polar white glossy	30055737	14,50
WS55E-pm	polar white mat	30055739	14,50
WS55E-wg	pure white glossy	30055707	14,50

E-DESIGN55 GERMAN SOCKETS (TYPE F)

Type	Color	Art. No.	€/pc.
------	-------	----------	-------



DSS55E-

German Socket (Type F) DSS with socket outlet front in E-Design55

German Socket (Type F) DSS with socket outlet front in E-Design55, 80x80 mm external dimensions, internal frame dimensions 55x55 mm. With increased shock protection. The socket base DSS bearing the VDE sign has plug-in terminals.

More informations:



<http://eltako.com/redirect/DSS55E->

DSS55E-am	anthracite mat	30055898	8,40
DSS55E-pg	polar white glossy	30055893	8,40
DSS55E-pm	polar white mat	30055894	8,40
DSS55E-wg	pure white glossy	30055895	8,40
DSS55E0R-am	anthracite mat	30056898	7,50
DSS55E0R-pg	polar white glossy	30056893	7,50
DSS55E0R-pm	polar white mat	30056894	7,50
DSS55E0R-wg	pure white glossy	30056895	7,50

*-OR' types without single frames included in the scope of delivery, for mounting in multiple or third-party frames.

Type	Color	Art. No.	€/pc.
------	-------	----------	-------



DSS55E0KR-

German socket (Type F) DSS with socket outlet front in E-Design55, without claws and frame

German socket (Type F) DSS with socket outlet front in E-Design55, without claws and frame. With increased shock protection. The socket base DSS with VDE mark, without fastening claws, has plug-in terminals. Minimum order quantity 10 pieces.

More informations:



<http://eltako.com/redirect/DSS55E0KR->

DSS55E0KR-am	anthracite mat	30057898	8,30
DSS55E0KR-pg	polar white glossy	30057893	8,30
DSS55E0KR-pm	polar white mat	30057894	8,30
DSS55E0KR-wg	pure white glossy	30057895	8,30

*-OKR' types without single frames included in the scope of delivery, for mounting in multiple or third-party frames.



DSS55E+2xUSBA-

German Socket (Type F) DSS with 2xUSB-A in E-Design55

German Socket (Type F) DSS with socket outlet front and USB charging ports in E-Design55, 80 x 80 mm external dimensions, internal frame dimensions 55 x 55 mm. With increased shock protection. The socket base has screw terminals. Installation depth 38 mm. Integrated USB power supply unit 5V DC/2.1A with short circuit and overload protection. Intelligent parallel use of both USB ports.

More informations:



<http://eltako.com/redirect/DSS55E+2xUSBA->

DSS55E+2xUSBA-am	anthracite mat	30055899	42,40
DSS55E+2xUSBA-pg	polar white glossy	30055891	42,40
DSS55E+2xUSBA-pm	polar white mat	30055892	42,40
DSS55E+2xUSBA-wg	pure white glossy	30055896	42,40



DSS55E+USBA+C-

German Socket (Type F) DSS with USB-A and USB-C in E-Design55

German Socket (Type F) DSS with socket outlet front and USB charging ports in E-Design55, 80 x 80 mm external dimensions, internal frame dimensions 55 x 55 mm. With increased shock protection. The socket base has screw terminals. Installation depth 38 mm. Integrated USB power supply unit 5V DC/2.8A with short circuit and overload protection. Intelligent parallel use of both USB ports.

More informations:



<http://eltako.com/redirect/DSS55E+USBA+C->

DSS55E+USBA+C-am	anthracite mat	30055900	50,30
DSS55E+USBA+C-pg	polar white glossy	30055901	50,30
DSS55E+USBA+C-pm	polar white mat	30055902	50,30
DSS55E+USBA+C-wg	pure white glossy	30055897	50,30

Type	Color	Art. No.	€/pc.
------	-------	----------	-------



BLA55E-

Blind cover BLA55E- E-Design55 for R1UE55, R2UE55, R3UE55 and R4UE55

More informations:



<http://eltako.com/redirect/BLA55E->

BLA55E-am	anthracite mat	30055640	4,40
BLA55E-pg	polar white glossy	30055641	4,40
BLA55E-pm	polar white mat	30055643	4,40
BLA55E-wg	pure white glossy	30055645	4,40

Type	Color	Art. No.	€/pc.
------	-------	----------	-------



TAE55E/3-

3-socket TAE cover for E-Design55 frames

Cover for 3-socket telecommunications access unit (TAE). For E-Design55 frames R1UE55, R2UE55, R3UE55, R4UE55 and R5UE55. Fits all Rutenbeck TAE access sockets.

More informations:



http://eltako.com/redirect/TAE55E*3-

TAE55E/3-am	anthracite mat	30055837	4,10
TAE55E/3-pg	polar white glossy	30055839	4,10
TAE55E/3-pm	polar white mat	30055841	4,10
TAE55E/3-wg	pure white glossy	30055836	4,10

5-15



UAE55E/2-

2-hole UAE/IAE cover for E-Design55 frames

Cover for 2-hole UAE/IAE (ISDN) and network sockets. For E-Design55 frames R1UE55, R2UE55, R3UE55, R4UE55 and R5UE55. Fits all Rutenbeck or Telegärtner 2-hole UAE/IAE (ISDN) and network sockets.

More informations:



http://eltako.com/redirect/UAE55E*2-

UAE55E/2-am	anthracite mat	30055843	4,10
UAE55E/2-pg	polar white glossy	30055844	4,10
UAE55E/2-pm	polar white mat	30055845	4,10
UAE55E/2-wg	pure white glossy	30055842	4,10



TV55E/2-

TV/RF cover for E-Design55 frames

2-hole cover for TV/RF aerial sockets. For E-Design55 frames R1UE55, R2UE55, R3UE55, R4UE55 and R5UE55. Fits all Hirschmann aerial sockets.

More informations:



http://eltako.com/redirect/TV55E*2-

TV55E/2-am	anthracite mat	30055830	4,10
TV55E/2-pg	polar white glossy	30055831	4,10
TV55E/2-pm	polar white mat	30055832	4,10
TV55E/2-wg	pure white glossy	30055838	4,10

E-DESIGN55 COVERS

Type	Color	Art. No.	€/pc.
------	-------	----------	-------



TV55E/3-

TV/RF/SAT cover for E-Design55 frames

3-hole cover for TV/RF/SAT aerial sockets.
For E-Design55 frames R1UE55, R2UE55, R3UE55,
R4UE55 and R5UE55. Fits all Hirschmann aerial
sockets.

More informations:



[http://ellako.com/redirect/
TV55E*3-](http://ellako.com/redirect/TV55E*3-)

Type	Color	Art. No.	€/pc.
------	-------	----------	-------

TV55E/3-am	anthracite mat	30055833	4,10
TV55E/3-pg	polar white glossy	30055834	4,10
TV55E/3-pm	polar white mat	30055835	4,10
TV55E/3-wg	pure white glossy	30055840	4,10

Type	Color	Art. No.	€/pc.
------	-------	----------	-------



R1UE55-

Single universal frames in E-Design55

Universal frames E-Design55. Single frames R1UE55, 80x80 mm external dimensions. Internal frame dimensions 55x55 mm.

The universal frames can be mounted horizontally and vertically.

For all wireless sensors of the 55 switching system.



R1UE55-am	anthracite mat	30055788	3,80
R1UE55-pg	polar white glossy	30055782	3,80
R1UE55-pm	polar white mat	30055783	3,80
R1UE55-wg	pure white glossy	30055785	3,80

Type	Color	Art. No.	€/pc.
------	-------	----------	-------



R2UE55-

Double universal frames in E-Design55

Universal frames E-Design55. Double frames R2UE55, 80 x 152 mm external dimensions. Internal frame dimensions 55x55 mm.

The universal frames can be mounted horizontally and vertically.

For all wireless sensors of the 55 switching system.



R2UE55-am	anthracite mat	30055738	4,90
R2UE55-pg	polar white glossy	30055787	4,90
R2UE55-pm	polar white mat	30055789	4,90
R2UE55-wg	pure white glossy	30055827	4,90



R3UE55-

Triple universal frames in E-Design55

Universal frames E-Design55. Triple universal frames R3UE55, 80 x 224 mm external dimensions. Internal frame dimensions 55x55 mm.

The universal frames can be mounted horizontally and vertically.

For all wireless sensors of the 55 switching system.



R3UE55-am	anthracite mat	30055748	5,50
R3UE55-pg	polar white glossy	30055749	5,50
R3UE55-pm	polar white mat	30055753	5,50
R3UE55-wg	pure white glossy	30055828	5,50



R4UE55-

4-way universal frames in E-Design55

Universal frames E-Design55. 4-way frames R4UE55, 80 x 292 mm external dimensions. Internal frame dimensions 55x55 mm.

The universal frames can be mounted horizontally and vertically.

For all wireless sensors of the 55 switching system.



R4UE55-am	anthracite mat	30055758	6,80
R4UE55-pg	polar white glossy	30055757	6,80
R4UE55-pm	polar white mat	30055755	6,80
R4UE55-wg	pure white glossy	30055826	6,80

E-DESIGN55 FRAMES

Type	Color	Art. No.	€/pc.
------	-------	----------	-------

Type	Color	Art. No.	€/pc.
------	-------	----------	-------



R5UE55-

5-way universal frames in E-Design55

Universal frames E-Design55. 5-way frames R5UE55, 80 x 363 mm external dimensions. Internal frame dimensions 55x55 mm.

The universal frames can be mounted horizontally and vertically.

For all wireless sensors of the 55 switching system.

More informations:



<http://ellako.com/redirect/R5UE55->

R5UE55-am	anthracite mat	30055778	7,70
R5UE55-pg	polar white glossy	30055759	7,70
R5UE55-pm	polar white mat	30055761	7,70
R5UE55-wg	pure white glossy	30055775	7,70

Type	Color	Art. No.	€/pc.
------	-------	----------	-------



FSAF-gr

Cover foil

Cover foil for the rear of wireless pushbuttons bonded to glass. Please specify the size required.

More informations:



<http://eltako.com/redirect/FSAF-gr>

FSAF-gr	grey	30999002	3,90
----------------	------	-----------------	-------------

Type	Color	Art. No.	€/pc.
------	-------	----------	-------



FTVW

Wireless pushbutton encryption rocker

The wireless pushbutton encryption rocker FTVW can be used to activate and deactivate the encryption of Eltako wireless pushbuttons, hand-held wireless transmitters and wireless remote control with batteryless and cordless EnOcean wireless modules. This excludes the tap-radio® pushbuttons and handheld transmitters using the EnOcean module PTM210.

More informations:



<http://eltako.com/redirect/FTVW>

FTVW	white	30000016	2,10
-------------	-------	-----------------	-------------

55 MM SWITCH SYSTEM WIRELESS PUSHBUTTONS AND WIRELESS SWITCHES

Type	Color	Art. No.	€/pc.
------	-------	----------	-------



FT55-



Wireless pushbutton 55 x 55 mm without battery and wire

Wireless pushbutton with rocker

Wireless 4-way pushbutton, 80 x 80 mm external dimensions, internal frame dimensions 55 x 55 mm, 15 mm high. Generates the power for wireless telegrams itself when the button is pressed, therefore there is no connecting wire and no standby loss.



Wireless pushbutton with double rocker



More informations:



<http://eltako.com/redirect/FT55->

FT55-al	coated/aluminium paint	30000591	65,90
FT55-an	anthracite	30000597	55,40
FT55-rw	pure white	30000592	55,40
FT55-wg	pure white glossy	30000595	55,40
FT55-ws	white	30000590	55,40

Type	Color	Art. No.	€/pc.
------	-------	----------	-------



WT55-



Rocker pushbutton 55 x 55 mm

More informations:



<http://eltako.com/redirect/WT55->

Rocker pushbutton, 1 NO contact 10 A/250 V AC. Pushbutton for single mounting 80 x 80 mm external dimensions, internal frame dimensions 55 x 55 mm, 15 mm high.

WT55-rw	pure white	30000622	12,80
WT55-wg	pure white glossy	30000625	12,80



WS55-



Rocker switch 55 x 55 mm

More informations:



<http://eltako.com/redirect/WS55->

Rocker switch, 1 CO contact 10 A/250 V AC. Switch for single mounting 80 x 80 mm external dimensions, internal frame dimensions 55 x 55 mm, 15 mm high.

WS55-rw	pure white	30000632	12,10
WS55-wg	pure white glossy	30000635	12,10

55 MM SWITCH SYSTEM GERMAN SOCKETS (TYPE F) / COVERS

Type	Color	Art. No.	€/pc.
------	-------	----------	-------



DSS+SD055-

German Socket (Type F) DSS with socket outlet front

German Socket (Type F) DSS with socket outlet front SD055. With increased shock protection.

More informations:



http://eltako.com/redirect/DSS*SD055-

DSS+SD055-rw	pure white	30000652	9,60
DSS+SD055-wg	pure white glossy	30000655	9,60

Type	Color	Art. No.	€/pc.
------	-------	----------	-------



BLA55-

Blind covers BLA55 for frames R-, R2- and R3-

More informations:



<http://eltako.com/redirect/BLA55->

BLA55-rw	pure white	30000642	4,40
BLA55-wg	pure white glossy	30000645	4,40



R-

Single universal frame for wireless pushbuttons

Frames internal dimensions 55x55 mm. Single frames, 80x80 mm external dimensions. 15 mm high.

More informations:



<http://eltako.com/redirect/R->

R-rw	pure white	30000182	4,90
R-wg	pure white glossy	30000185	4,90

55 MM SWITCH SYSTEM ACCESSOIRES

Type	Color	Art. No.	€/pc.
------	-------	----------	-------

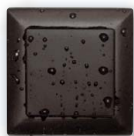

SWS55/W-an

Splash-proof cover for FT55 with single rocker, anthracite

IP54: for protection against splashing water, dust and dirt.

Material: silicone.

Simple assembly by slipping over the already assembled pushbuttons.

More informations:



http://eltako.com/redirect/SWS55*W-an

SWS55/W-an	anthracite	30000055	12,20
------------	------------	----------	-------

Type	Color	Art. No.	€/pc.
------	-------	----------	-------

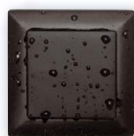

SWS55/DW-an

Splash-proof cover for FT55 with double rocker, anthracite

IP54: for protection against splashing water, dust and dirt.

Material: silicone.

Simple assembly by slipping over the already assembled pushbuttons.

More informations:



http://eltako.com/redirect/SWS55*DW-an

SWS55/DW-an	anthracite	30000057	12,20
-------------	------------	----------	-------



FSAF-gr

Cover foil

Cover foil for the rear of wireless pushbuttons bonded to glass. Please specify the size required.

More informations:



<http://eltako.com/redirect/FSAF-gr>

FSAF-gr	grey	30999002	3,90
---------	------	----------	------



FTVW

Wireless pushbutton encryption rocker

The wireless pushbutton encryption rocker FTVW can be used to activate and deactivate the encryption of Eltako wireless pushbuttons, hand-held wireless transmitters and wireless remote control with batteryless and cordless EnOcean wireless modules. This excludes the tap-radio® pushbuttons and handheld transmitters using the EnOcean module PTM210.

More informations:



<http://eltako.com/redirect/FTVW>

FTVW		30000016	2,10
------	--	----------	------

COMPATIBLE SENSORS WIRELESS PUSHBUTTONS

Type	Color	Art. No.	€/pc.
------	-------	----------	-------



FT55R-

Wireless 2- or 4-way pushbutton, without frame

Wireless pushbutton with rocker (without frame)



Wireless pushbutton with double rocker (w/o frame)



More informations:



<http://eltako.com/redirect/FT55R->

FT55R-alpinwhite	alpine white	30000226	62,00
FT55R-white	white	30000225	62,00

Type	Color	Art. No.	€/pc.
------	-------	----------	-------



FT4B-

Wireless 2- or 4-way pushbutton 45 x 45 mm Belgium, without frame, without battery and wire

Wireless pushbutton with rocker (without frame)



Wireless pushbutton with double rocker (w/o frame)



More informations:



<http://eltako.com/redirect/FT4B->

FT4B-cr	niko creme	30000229	62,00
FT4B-na	niko anthracite	30000240	62,00
FT4B-nw	niko white	30000221	62,00

5-23



FT4BL-lw

Wireless 2- or 4-way pushbutton 45 x 45 mm Belgium, without frame, legrand white, without battery and wire

Wireless pushbutton with rocker (without frame)



Wireless pushbutton with double rocker (w/o frame)



More informations:



<http://eltako.com/redirect/FT4BL-lw>

FT4BL-lw	legrand white	30000241	62,00
-----------------	---------------	-----------------	--------------



FT4BI-

Wireless 2- or 4-way pushbutton 43 x 43 mm, without frame, without battery and wire

Wireless pushbutton with rocker (without frame)



Wireless pushbutton with double rocker (w/o frame)



More informations:



<http://eltako.com/redirect/FT4BI->

FT4BI-an	bticino anthracite	30000245	62,00
FT4BI-ww	bticino w.white	30000246	62,00

COMPATIBLE SENSORS WIRELESS PUSHBUTTONS

Type	Color	Art. No.	€/pc.
------	-------	----------	-------



FT4CH-

Wireless 2- or 4-way pushbutton without battery or wire, without frame

Wireless pushbutton with rocker (without frame)

Wireless 2- or 4-way pushbutton for internal frame dimensions 60 x 60 mm, 15 mm high, Feller Swiss. Generates the power for wireless telegrams itself when the button is pressed, therefore there is no connecting wire and no standby loss. With rocker and double rocker. Also for cover frames from ABB Normelec and Hager.



Wireless pushbutton with double rocker (w/o frame)

Battery-free
by EnOcean

More informations:



<http://eltako.com/redirect/FT4CH->

FT4CH-hg	light grey	30000223	62,00
FT4CH-sz	black	30000224	62,00
FT4CH-w	white	30000222	62,00

Type	Color	Art. No.	€/pc.
------	-------	----------	-------



FT4CH+2P-w

Wireless 2- or 4-way pushbutton without battery or wire, without frame, laser engraved, white

Wireless pushbutton with intermediate frame and rocker laser engraved (without frame)

Wireless 2- or 4-way pushbutton for internal frame dimensions 60 x 60 mm, 15 mm high, Feller Swiss. Generates the power for wireless telegrams itself when the button is pressed, therefore there is no connecting wire and no standby loss. With rocker and double rocker laser engraved. Also for cover frames from ABB Normelec and Hager.



Wireless pushbutton with intermediate frame and double rocker laser engraved (without frame)

Battery-free
by EnOcean

More informations:



<http://eltako.com/redirect/FT4CH+2P-w>

FT4CH+2P-w	white	30001222	68,90
------------	-------	----------	-------



FT55ES-wg

Wireless 2- or 4-way pushbutton Sweden, without frame, exact white

Wireless pushbutton with rocker (without frame)

Wireless 2- or 4-way pushbutton 55 x 55 mm Sweden, exact white. Generates the power for wireless telegrams itself when the button is pressed, therefore there is no connecting wire and no standby loss.



Wireless pushbutton with double rocker (without frame)

Battery-free
by EnOcean



<http://eltako.com/redirect/FT55ES-wg>

FT55ES-wg	exact white	30000244	62,00
-----------	-------------	----------	-------



FT4S-ws

Wireless 2- or 4-way pushbutton Sweden, without frame, eljo white

Wireless pushbutton with rocker (without frame)

Wireless 2- or 4-way pushbutton 55 x 55 mm Sweden eljo white. Generates the power for wireless telegrams itself when the button is pressed, therefore there is no connecting wire and no standby loss.



Wireless pushbutton with double rocker (without frame)

Battery-free
by EnOcean



<http://eltako.com/redirect/FT4S-ws>

FT4S-ws	eljo white	30000220	62,00
---------	------------	----------	-------

COMPATIBLE SENSORS WIRELESS PUSHBUTTONS

Type	Color	Art. No.	€/pc.
------	-------	----------	-------



FT55RS-alpinwhite



Wireless 2- or 4-way pushbutton Sweden, without frame, jussi white

Wireless pushbutton with rocker (without frame)

Wireless 2- or 4-way pushbutton 55x55 mm Sweden jussi white. Generates the power for wireless telegrams itself when the button is pressed, therefore there is no connecting wire and no standby loss.



Wireless pushbutton with double rocker (without frame)



More informations:



<http://eltako.com/redirect/FT55RS-alpinwhite>

FT55RS-alpinwhite	jussi white	30000243	62,00
--------------------------	-------------	-----------------	--------------

Type	Color	Art. No.	€/pc.
------	-------	----------	-------

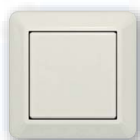

FT55EL-ws



Wireless 2- or 4-way pushbutton Finland, without frame, elko white

Wireless pushbutton with rocker (without frame)

Wireless 2- or 4-way pushbutton 55 x 55 mm Finland elko white. Generates the power for wireless telegrams itself when the button is pressed, therefore there is no connecting wire and no standby loss.



Wireless pushbutton with double rocker (without frame)



More informations:



<http://eltako.com/redirect/FT55EL-ws>

FT55EL-ws	elko-white	30000227	62,00
------------------	------------	-----------------	--------------



FMT55/2-



Wireless 2-way mini pushbutton without battery or wire, with rocker

Wireless mini pushbutton with rocker

Wireless mini pushbutton, 55x55 mm external dimensions, 15 mm high. Generates the power for wireless telegrams itself when the button is pressed, therefore there is no connecting wire and no standby loss.



More informations:



http://eltako.com/redirect/FMT55*2-

FMT55/2-rw	pure white	30000192	54,80
FMT55/2-wg	pure white glossy	30000195	54,80



FMT55/4-



Wireless mini pushbutton without battery or wire, with double rocker

Wireless mini pushbutton with double rocker

Wireless mini pushbutton, 55 x 55 mm external dimensions, 15 mm high, with double rocker. Generates the power for wireless telegrams itself when the button is pressed, therefore there is no connecting wire and no standby loss.



More informations:



http://eltako.com/redirect/FMT55*4-

FMT55/4-rw	pure white	30000262	57,20
FMT55/4-wg	pure white glossy	30000265	57,20

COMPATIBLE SENSORS WIRELESS PUSHBUTTONS AND ACCESSOIRES

Type	Color	Art. No.	€/pc.
------	-------	----------	-------



FT4F-



Wireless flat pushbutton without battery or wire

Wireless pushbutton with rocker

Wireless 4-way flat pushbutton, 80 x 80 mm external dimensions, internal frame dimensions 63 x 63 mm, 15 mm high. Generates the power for wireless telegrams itself when the button is pressed, therefore there is no connecting wire and no standby loss.



Wireless pushbutton with double rocker



More informations:



<http://eltako.com/redirect/FT4F->

FT4F-am	anthracite mat	30000708	68,30
FT4F-pg	polar white glossy	30000706	59,80
FT4F-pm	polar white mat	30000709	59,80
FT4F-rw	pure white	30000702	55,40
FT4F-wg	pure white glossy	30000705	55,40



HP+BF

Mounting plate with mounting frame for EnOcean module PTM..., usage with i.g. FT55, F2T55E, F4T55E and FS55E

More informations:



<http://eltako.com/redirect/HP+BF>

HP+BF	grey	30000356	5,70
-------	------	----------	------

Type	Color	Art. No.	€/pc.
------	-------	----------	-------



FTE215



Wireless pushbutton insert EnOcean, encrypted, with mounting base and attachment frame



Wireless pushbutton insert with EnOcean energy generators for wireless pushbuttons made by other manufacturers. Generates the power for wireless telegrams itself when the button is pressed, therefore there is no connecting wire and no standby loss.

More informations:



<http://eltako.com/redirect/FTE215>

The scope of supply comprises the mounting base and an attachment frame for FT55 with EnOcean module inserts PTM215 (encrypted).

Wireless pushbuttons with one rocker can transmit two evaluable signals. Wireless pushbuttons with double rocker can transmit four evaluable signals.

FTE215	grey	30999003	52,70
--------	------	----------	-------

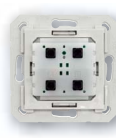

FTE215B



Wireless pushbutton insert with 4-channel push-button module, can be encrypted. Very quiet and with battery (service life 5-7 years).



Mehr Informationen:



<http://eltako.com/redirect/FTE215B>

The scope of delivery includes a retaining plate and a mounting frame for the FT55 with the FTE215B button module used, including the CR2032 battery. Wireless pushbuttons with one rocker can send two signals that can be evaluated, wireless pushbuttons with double rockers can send four signals that can be evaluated. Pull out the insulating strip before start-up.

FTE215B	grey	30999004	52,70
---------	------	----------	-------

COMPATIBLE SENSORS

FRIENDS OF HUE SENSORS / BLUETOOTH WIRELESS PUSHBUTTON INSERT

Type	Color	Art. No.	€/pc.
------	-------	----------	-------



Wireless pushbutton with double rocker



More informations:



<http://eltako.com/redirect/FT55EH->

FT55EH-

Friends of Hue wireless pushbutton in E-Design55

Friends of Hue wireless pushbutton for single mounting 80x80x15 mm or mounting into the E-Design55 switching system. Generates the power for wireless telegrams itself when the button is pressed, therefore there is no connecting wire and no standby loss.

ATTENTION: Not compatible with EnOcean wireless actuators!

FT55EH-am	anthracite mat	30055732	57,40
FT55EH-pg	polar white glossy	30055719	57,40
FT55EH-pm	polar white mat	30055723	57,40
FT55EH-wg	pure white glossy	30055717	57,40

Type	Color	Art. No.	€/pc.
------	-------	----------	-------



Wireless pushbutton with double rocker



More informations:



<http://eltako.com/redirect/FT55H-wg>

FT55H-wg

Friends of Hue wireless pushbutton, pure white glossy

Friends of Hue wireless pushbutton for single mounting 80x80x15 mm or mounting in the 55 mm switch system. Generates the power for wireless telegrams itself when the button is pressed, therefore there is no connecting wire and no standby loss.

ATTENTION: Not compatible with EnOcean wireless actuators!

FT55H-wg	pure white glossy	30000596	60,80
----------	-------------------	----------	-------



More informations:



<http://eltako.com/redirect/FTE215BLE>

FTE215BLE

Wireless pushbutton insert, Bluetooth

Wireless pushbutton insert with EnOcean energy generators for wireless pushbuttons made by other manufacturers. Generates the power for wireless telegrams itself when the button is pressed, therefore there is no connecting wire and no standby loss.

The scope of supply comprises the mounting base and an attachment frame for FT55 with EnOcean module inserts PTM215B (Bluetooth).

Wireless pushbuttons with one rocker can transmit two evaluable signals. Wireless pushbuttons with double rocker can transmit four evaluable signals.

ATTENTION: Not compatible with EnOcean wireless actuators!

FTE215BLE	grey	30999005	62,20
-----------	------	----------	-------

REMOTE CONTROLS AND FURTHER SENSORS HAND-HELD TRANSMITTERS

Type	Color	Art. No.	€/pc.
------	-------	----------	-------



FMH1W-anso



Wireless mini handheld transmitter, waterproof, without battery or wire



More informations:



<http://eltako.com/redirect/FMH1W-anso>

Wireless mini handheld transmitter waterproof 72 x 30 mm, 15 mm high. Weighs only 34 grams. Generates the power for wireless telegrams itself when the button is pressed, therefore there is no battery.

FMH1W-anso	anthracite soft	30000467	62,70
------------	-----------------	----------	-------

Type	Color	Art. No.	€/pc.
------	-------	----------	-------



FMH1W-wg/rot



Wireless mini handheld transmitter, waterproof, without battery or wire



More informations:



http://eltako.com/redirect/FMH1W-wg*rot

Wireless mini handheld transmitter waterproof 72 x 30 mm, 15 mm high. Weighs only 34 grams. Generates the power for wireless telegrams itself when the button is pressed, therefore there is no battery.

FMH1W-wg/rot	grey carry strap; casing pure white glossy, button red	30000465	66,70
--------------	--	----------	-------



FTTB



Wireless pushbutton tracker, without wire

More informations:



<http://eltako.com/redirect/FTTB>

Wireless pushbutton tracker with battery (lifetime 5-8 years). 55 x 44 mm, 15 mm high. Weighs only 20 grams. The wireless pushbutton tracker FTTB has a blue pushbutton to send normal pushbutton telegrams. After opening the housing (grasp into the joint and prise apart), switch the tracker on by shifting the slide switch to the *w* position. The sensor then sends a presence telegram every 60 seconds. An internal 3 V button cell CR2032 supplies power for several years.

FTTB	anthracite	30100018	75,00
------	------------	----------	-------



FMH2-



Wireless 2-way mini handheld transmitter laser engraved 0 + I, without battery or wire



More informations:



<http://eltako.com/redirect/FMH2->

Wireless 2-way mini handheld transmitter 43 x 43 mm, 16 mm high. Weighs only 30 grams. Generates the power for wireless telegrams itself when the button is pressed, therefore there is no battery.

FMH2-an	anthracite	30000757	63,20
FMH2-rw	pure white	30000752	63,20
FMH2-sz	black	30000754	63,20
FMH2-wg	pure white glossy	30000755	63,20
FMH2-ws	white	30000750	63,20

REMOTE CONTROLS AND FURTHER SENSORS HAND-HELD TRANSMITTERS

Type	Color	Art. No.	€/pc.
------	-------	----------	-------



FMH2S-



Wireless 2-way mini handheld transmitter for key ring laser engraved 0 + I, without battery or wire



Wireless 2-way mini handheld transmitter 43 x 43 mm, 16 mm high. Weighs only 30 grams. Also prepared to attach a key fob. Generates the power for wireless telegrams itself when the button is pressed, therefore there is no battery.

More informations:



<http://eltako.com/redirect/FMH2S->

FMH2S-an	anthracite	30000087	63,20
FMH2S-rw	pure white	30000082	63,20
FMH2S-sz	black	30000084	63,20
FMH2S-wg	pure white glossy	30000085	63,20
FMH2S-ws	white	30000080	63,20

Type	Color	Art. No.	€/pc.
------	-------	----------	-------



FHS2-al/anso



Wireless 2-way handheld transmitter without battery or wire, with rocker, aluminium/anthracite-soft



Wireless 2-way handheld transmitter with rocker aluminium/anthracite-soft, 49 x 47 mm, 16 mm high. Weighs only 37 grams. Generates the power for wireless telegrams itself when the button is pressed, therefore there is no battery.

More informations:



<http://eltako.com/redirect/FHS2-al/anso>

FHS2-al/anso	alu/anthracite-soft	30000771	6,20
--------------	---------------------	----------	------



FMH4-



Wireless 4-way mini handheld transmitter, laser engraved 1+2+3+4, without battery or wire



Wireless 4-way mini handheld transmitter 43 x 43 mm, 16 mm high. Weighs only 30 grams. Generates the power for wireless telegrams itself when the button is pressed, therefore there is no battery.

More informations:



<http://eltako.com/redirect/FMH4->

FMH4-an	anthracite	30000237	66,50
FMH4-rw	pure white	30000232	66,50
FMH4-sz	black	30000234	66,50
FMH4-wg	pure white glossy	30000235	66,50
FMH4-ws	white	30000230	66,50



FMH4S-



Wireless mini handheld transmitter for key ring, laser engraved 1+2+3+4, without battery or wire



Wireless 4-way mini handheld transmitter 43 x 43 mm, 16 mm high. Weighs only 30 grams. Also prepared to attach a key fob. Generates the power for wireless telegrams itself when the button is pressed, therefore there is no battery.

More informations:



<http://eltako.com/redirect/FMH4S->

FMH4S-an	anthracite	30000097	66,50
FMH4S-rw	pure white	30000092	66,50
FMH4S-sz	black	30000094	66,50
FMH4S-wg	pure white glossy	30000095	66,50
FMH4S-ws	white	30000090	66,50

REMOTE CONTROLS AND FURTHER SENSORS HAND-HELD TRANSMITTERS

Type	Color	Art. No.	€/pc.
------	-------	----------	-------



FHS4-al/anso



Wireless 4-way handheld transmitter without battery or wire, with double rocker, aluminium/anthracite-soft



Wireless 4-way handheld transmitter with rocker aluminium/anthracite-soft, 49 x 47 mm, 16 mm high. Weighs only 37 grams. Generates the power for wireless telegrams itself when the button is pressed, therefore there is no battery.

More informations:



<http://eltako.com/redirect/FHS4-al/anso>

FHS4-al/anso	aluminium/ anthracite-soft	30000770	69,00
--------------	-------------------------------	----------	-------

Type	Color	Art. No.	€/pc.
------	-------	----------	-------



FMH8-



Wireless 8-way mini handheld transmitter, laser engraved 1+2+3+4+5+6+7+8, without battery or wire



Wireless 8-way mini handheld transmitter 45 x 85 mm, 18 mm high. Weighs only 60 grams. Generates the power for wireless telegrams itself when the button is pressed, therefore there is no battery.

More informations:



<http://eltako.com/redirect/FMH8->

FMH8-ag	anthracite glossy	30000454	104,50
FMH8-al/anso	top painted in aluminium, bottom and rockers anthracite-soft paintpaint	30000419	107,40
FMH8-wg	pure white glossy	30000455	104,50



FHS8-wg



Wireless handheld transmitter, 2 double rockers pure white glossy

Wireless 8-way hand-held transmitter 154x50mm, 16mm high. Weighs only 87 grams. Generates the power for wireless telegrams itself when the button is pressed, therefore there is no battery. Smart Home sensor.



More informations:



<http://eltako.com/redirect/FHS8-wg>

FHS8-wg	pure white glossy	30000205	99,90
---------	-------------------	----------	-------



FHS8B-wg



Wireless handheld transmitter with battery, 2 double rockers pure white glossy

Wireless 8-way hand-held transmitter 154x50mm, 16mm high. Weighs only 75 grams. Whisper quiet and with battery (lifetime 5-7 years). Smart Home sensor.

More informations:



<http://eltako.com/redirect/FHS8B-wg>

FHS8B-wg	pure white glossy	30000206	99,90
----------	-------------------	----------	-------

REMOTE CONTROLS AND FURTHER SENSORS HAND-HELD TRANSMITTERS / OTHER SENSORS

Type	Color	Art. No.	€/pc.
------	-------	----------	-------



FF8-al/anso



Wireless 8-way remote control with 2 double rockers, without battery or wire

Wireless 8-way remote control 185x50 mm, 17 mm high. Generates the power for wireless telegrams itself when the button is pressed, therefore there is no battery. With wall holder WHF-al and 2 stainless-steel countersunk screws 2.9x25 mm and plugs 5x25 mm.



More information:

<http://eltako.com/redirect/FF8-al'anso>

FF8-al/anso	top painted aluminium, bottom and rockers anthracite-soft paint	30000769	121,30
--------------------	---	-----------------	---------------

Type	Color	Art. No.	€/pc.
------	-------	----------	-------



FFD-al/anso



Wireless 50-way remote control with display and rechargeable battery. With wall holder and charger

Wireless 50-way remote control with display 185x50 mm, 17 mm high. Power is supplied by lithium-ion battery whose voltage is monitored and shown in the display. With charger, wall holder WHF-al and 2 stainless-steel countersunk screws 2.9x25 mm and plugs 5x25 mm.

More information:



<http://eltako.com/redirect/FFD-al'anso>

FFD-al/anso	top painted aluminium bottom anthracite-soft paint	30000773	132,70
--------------------	--	-----------------	---------------

5-31



FKf65-wg



Key card switch in E-Design65

Wireless card switch for surface mounting 84x84x29 mm. Generates the power for wireless telegrams itself when the button is pressed, therefore there is no connecting wire and no standby loss.



More information:

<http://eltako.com/redirect/FKf65-wg>

FKf65-wg	pure white glossy	30065545	65,60
-----------------	-------------------	-----------------	--------------



FZS65-wg



Wireless pull switch in E-Design65

Wireless pull switch for surface mounting 84x84x24 mm. With silver and red handle. Generates the power for wireless telegrams itself when the button is pressed, therefore there is no connecting wire and no standby loss.

When the handle is pulled and released, a wireless telegram is sent to the Eltako wireless network. The scope of supply includes the completely assembled pull switch, a silver handle, a red handle and two screws and rawl plugs.



More information:

<http://eltako.com/redirect/FZS65-wg>

FZS65-wg	pure white glossy	30067545	96,90
-----------------	-------------------	-----------------	--------------

REMOTE CONTROLS AND FURTHER SENSORS HAND-HELD TRANSMITTERS / OTHER SENSORS

Type	Color	Art. No.	€/pc.
------	-------	----------	-------



FIT80-



Wireless 1-way pushbutton without battery or wire.



Wireless 1-way pushbutton 80x40x15 mm, with energy generator. Protection class IP54. Generates the energy for radio telegrams by pushing the button, therefore without connecting cable and no stand-by loss.

The wireless 1-way pushbutton transmits 1 signal that can be evaluated.

It can be screwed onto a flat surface or glued to the wall using the enclosed adhesive foil.

More informations:



<http://eltako.com/redirect/FIT80->

FIT80-am	anthracite mat	30000453	50,80
FIT80-wg	pure white glossy	30000451	50,80

Type	Color	Art. No.	€/pc.
------	-------	----------	-------



FKD-



Wireless bell pushbutton without battery or wire.



Wireless bell pushbutton 80x40x15 mm with energy generator. Protection class IP54. Generates the energy for radio telegrams by pushing the button, therefore without connecting cable and no stand-by loss.

Labeling field 43x12 mm. For example for Dymo label tape 9 mm and 12 mm. The radio bell pushbutton transmits 1 signal that can be evaluated like a 1-way wireless pushbutton.

More informations:



<http://eltako.com/redirect/FKD->

FKD-am	anthracite mat	30000408	59,70
FKD-wg	pure white glossy	30000420	59,70



FLT58-am



Wireless air quality desktop sensor + temperature and humidity

FLT58-am, anthracite mat

Wireless air quality desktop sensor + temperature and humidity, 58x58x58 mm. With LED display to signal room air quality. Additionally with a warning signal from level red. Power supply with the included power supply unit with USB-C connector. Stand-by loss only 0,1 watt.



More informations:



<http://eltako.com/redirect/FLT58-am>

FLT58-am	anthracite mat	30058520	108,00
-----------------	----------------	-----------------	---------------



FC02TS-wg



Wireless CO₂ desktop sensor temperature+ humidity sensor and signal

More informations:



<http://eltako.com/redirect/FC02TS-wg>

Dimensions: 85x85x65 mm. With slip-resistant plastic feet. With controlled LED display according to the ambient air quality and brightness. Additionally with warning signal at level red. Standby loss only 0.4 watts on average. Power supply with enclosed plug-in power supply with 200 cm connection cable.

FC02TS-wg	pure white glossy	30065278	246,20
------------------	-------------------	-----------------	---------------

REMOTE CONTROLS AND FURTHER SENSORS HAND-HELD TRANSMITTERS / OTHER SENSORS

Type	Color	Art. No.	€/pc.
------	-------	----------	-------



FTFSB-



Wireless temperature+humidity sensor with solar cell and battery (lifetime 5 years), 75x25x12 mm.

More informations:



<http://eltako.com/redirect/FTFSB->

The wireless temperature humidity sensor measures constantly the relative humidity between 0 and 100% (+-5%) and the temperature between -20°C and +60°C (+-0,5°C). It sends a data telegram within 2 minutes if changed in the Eltako wireless network. If there is no change, a status telegram is sent every 10 minutes. Adhesive foil mounting, an adhesive film is enclosed. The electronics are powered by an internal button cell CR2032. To change only the housing needs to be opened. This is also required to activate the battery supply by pulling out an insulating strip.

FTFSB-am	anthracite mat	30000475	83,90
FTFSB-wg	pure white glossy	30000563	83,90

Type	Color	Art. No.	€/pc.
------	-------	----------	-------



FTFB-



Wireless temperature+humidity sensor, 75x25x12 mm, with battery (lifetime 5 years).

More informations:



<http://eltako.com/redirect/FTFB->

The temperature humidity sensor measures constantly the relative humidity between 0 and 100% (+-5%) and the temperature between -20°C and +60°C (+-0,5°C). It sends a data telegram within 2 minutes if changed in the Eltako wireless network. If there is no change, a status telegram is sent every 10 minutes. Adhesive foil mounting, an adhesive film is enclosed. The electronics are powered by an internal button cell CR2032. To change only the housing needs to be opened. This is also required to activate the battery supply by pulling out an insulating strip.

FTFB-am	anthracite mat	30000429	77,40
FTFB-wg	pure white glossy	30000559	77,40

5-33



FFT60SB



Wireless humidity temperature sensor indoors and outdoors with solar cell and battery

More informations:



<http://eltako.com/redirect/FFT60SB>

Wireless humidity temperature sensor pure white with solar cell and battery (lifetime 3-5 years), 60 x 46 x 30 mm.

FFT60SB	pure white	30000461	84,70
----------------	------------	-----------------	--------------

REMOTE CONTROLS AND FURTHER SENSORS HAND-HELD TRANSMITTERS / OTHER SENSORS

Type	Color	Art. No.	€/pc.
------	-------	----------	-------



FABH65S-wg



Wireless outdoor motion/brightness sensor in E-Design65

Wireless outdoor motion/brightness sensor pure white glossy for surface mounting, 84 x 84 x 39 mm, protection class IP54. With solar cell.



More informations:



<http://eltako.com/redirect/FABH65S-wg>

FABH65S-wg	pure white glossy	30065852	120,90
------------	-------------------	----------	--------

Type	Color	Art. No.	€/pc.
------	-------	----------	-------



FABH130/230V-rw



Wireless outdoor motion/brightness sensor

Wireless outdoor motion/brightness sensor pure white, 130 x 85 x 100 mm, protection class IP55. 1 NO contact not potential free 10 A/250 V AC, incandescent lamps 2300 Watt. Power supply 230 V. Only 0.9 watt standby loss.

The wireless sensor can be taught in the actuators listed below and in controller: FSR14, FSR61, FSR71.

More informations:



http://eltako.com/redirect/FABH130*230V-rw

FABH130/230V-rw	pure white	30000466	149,20
-----------------	------------	----------	--------



FHD60SB-wg



Wireless brightness twilight sensor indoors and outdoors with solar cells and battery

Wireless brightness twilight sensor pure white with solar cells and battery (lifetime 5-8 years). For indoors and outdoors. l x w x h: 60 x 46 x 30 mm. The sensor covers the range from 0 to 30 000 lux. Actuators can cover the range from 0 to 50 Lux using the twilight switch function.

More informations:



<http://eltako.com/redirect/FHD60SB-wg>

FHD60SB-wg	pure white	30000462	83,70
------------	------------	----------	-------



FWS60



Water sensor for connection to the wireless transmitter module FSM60B

Water sensor FWS60 for connection to the wireless transmitter module FSM60B pure white. l x w x h: 60 x 46 x 30 mm (dimensions without screw connection). With 150 cm connecting cable.

More informations:



<http://eltako.com/redirect/FWS60>

FWS60	pure white	30000463	33,10
-------	------------	----------	-------

REMOTE CONTROLS AND FURTHER SENSORS HAND-HELD TRANSMITTERS / OTHER SENSORS

Type	Color	Art. No.	€/pc.
------	-------	----------	-------



FSM60B

Wireless transmitter module with batteries and antenna rod. L x W x H: 60 x 46 x 30 mm (dimensions excluding antenna and fixing screws)

This wireless transmitter module can be operated by a water sensor FWS60 or a pushbutton and transmits a variety of adjustable wireless telegrams to the Eltako building wireless system.

An internal jumper permits selection between 4 operating modes.



<http://eltako.com/redirect/FSM60B>

FSM60B	pure white	30000459	76,90
--------	------------	----------	-------

Type	Color	Art. No.	€/pc.
------	-------	----------	-------



FASM60-UC

Wireless outdoor transmitter module 2 channels. L x W x H: 60 x 46 x 30 mm (dimensions excluding fixing screws). With internal antenna. No standby loss.

The wireless transmitter module FASM60-UC has two channels and can transmit wireless pushbutton telegrams to the Eltako building wireless system.

A1 initiates a wireless telegram, such as 'Press top rocker' for a wireless pushbutton with one rocker and A3 such as 'Press bottom rocker'. The telegram on opening the two control contacts is identical to 'Release wireless pushbutton'.

Several wireless transmitter modules must not be switched at the same time.

There is a screw joint M12 at the bottom for the waterproof connection IP54. Connection to a 5-fold inside terminal for the control input +A1/-A2 and +A3/-A2.

More informations:



<http://eltako.com/redirect/FASM60-UC>

FASM60-UC	pure white	30000456	74,50
-----------	------------	----------	-------



FWS81

Wireless water sensor with swelling discs

Wireless water sensor with swelling discs and energy generator, 88 x 50 x 30 mm, white. No standby loss.



<http://eltako.com/redirect/FWS81>

FWS81	white	30000409	162,80
-------	-------	----------	--------



FRWB-rw

Wireless smoke detector with battery

Wireless smoke detector pure white with wireless emitter module in the base. Ø86 mm, 49 mm high. With solar cell and battery (lifetime 10 years).

More informations:



<http://eltako.com/redirect/FRWB-rw>

FRWB-rw	pure white	30000054	158,40
---------	------------	----------	--------

REMOTE CONTROLS AND FURTHER SENSORS HAND-HELD TRANSMITTERS / OTHER SENSORS

Type	Color	Art. No.	€/pc.
------	-------	----------	-------



FHMB-rw

Wireless heat detector

Wireless heat detector pure white with wireless emitter module in the base. Ø86 mm, 45 mm high. With solar cell and battery (lifetime 10 years).

More informations:



<http://eltako.com/redirect/FHMB-rw>



FHMB-rw	pure white	30000056	166,80
---------	------------	----------	--------

Type	Color	Art. No.	€/pc.
------	-------	----------	-------



FFTE-rw

Wireless window touch contact with energy generator pure white, 48 x 32 x 11.5 mm. Also for monitoring of doors, drawers and other mobile equipment. Generates the power for wireless telegrams when the button is pressed. Therefore, no connecting wire and no standby losses.

Battery-free
by EnOcean



<http://eltako.com/redirect/FFTE-rw>



More informations:



<http://eltako.com/redirect/BW3>

A wireless telegram is sent when a window is opened or closed. For more than 100,000 switching cycles. Evaluated via FHK14, FHK61, FSB14, FSB61, FSB71, FSR14, FSR61, FSR71, FZK14, FZK61 and Professional Smart Home controller. Attach by affixing supplied adhesive foil, screwing on or using the supplied mounting bracket.

FFTE-rw	pure white	30000450	64,20
BW3	white	30000412	3,90



FTKE-rw

Wireless window/door contact with energy generator 48 x 32 x 11.5 mm, pure white. Also for monitoring of drawers and other mobile equipment. Generates the power for wireless telegrams itself when the lever is pressed, therefore there is no battery, no connecting wire and no standby loss. Fixing by gluing, screwing or with mounting brackets BW3.

More informations:



<http://eltako.com/redirect/FTKE-rw>



More informations:



<http://eltako.com/redirect/BW3>

A wireless telegram is sent when a window is opened or closed. For more than 100,000 switching cycles, replaceable compression spring. Evaluated via FHK14, FHK61, FSB14, FSB61, FSB71, FSR14, FSR61, FSR71, FZK14, FZK61 and controller.

Attach by affixing supplied adhesive foil, screwing on or using the supplied mounting bracket.

FTKE-rw	pure white	30000400	62,30
BW3	white	30000412	3,90



FFKB-

Wireless window/door contact, 75 x 25 x 12 mm, with battery (lifetime 7 years). Magnet 37 x 10 x 6 mm.

More informations:



<http://eltako.com/redirect/FFKB->

On opening and closing, the related telegram is sent twice in short succession. The current status telegram is sent cyclically every approx. 8 minutes. Attach by bonding.

FFKB-am	anthracite mat	30000425	73,10
FFKB-wg	pure white glossy	30000423	73,10

REMOTE CONTROLS AND FURTHER SENSORS HAND-HELD TRANSMITTERS / OTHER SENSORS

Type	Color	Art. No.	€/pc.
------	-------	----------	-------



FTKB-



Wireless window/door contact with solar cell and battery (lifetime 8 years) 75 x 25 x 12 mm. Adhesive foil mounting.

Wireless window/door contact with solar cell and battery 75 x 25 x 12 mm. Starting at 100 Lux daylight the window/door contact FTKB powers itself from a solar cell, otherwise several years with a button cell. On opening and closing, the related telegram is send twice in short succession. The current status telegram is sent cyclically every approx. 8 minutes. Adhesive foil mounting.



FTKB-am	anthracite mat	30000474	73,40
FTKB-wg	pure white glossy	30000424	73,40



FTK-



Wireless window/door contact with solar cell

Wireless window/door contact with solar cell 75 x 25 x 12 mm. Adhesive foil mounting. Protection class IP54, therefore suitable for outdoor mounting.



FTK-ag	anthracite glossy	30000407	85,90
FTK-am	anthracite mat	30000452	85,90
FTK-wg	pure white glossy	30000421	85,90

Type	Color	Art. No.	€/pc.
------	-------	----------	-------



FFG7B-



Wireless window handle sensor, 120 x 35 x 7 mm, with battery (lifetime 7 years). Mounts behind a standard window handle with a 7 mm square pin and variable or fixed pin length. Smart Home sensor.

Wireless transmit telegrams for window positions open, tilted and closed. Status telegram every 15 minutes. **Very simple installation under standard window handle: Unscrew handle, fit sensor, and screw handle back on.**

In individual cases, the square pin of the window handle is too short when using the FFG7B- and can be extended using the pin extension SV7x7x14 accessory.



pin extension SV7x7x14



FFG7B-al	coated/aluminium paint	30000460	76,60
FFG7B-am	anthracite mat	30000468	76,60
FFG7B-rw	pure white	30000443	76,60
SV7x7x14	metallic	30000031	14,10



mTronic



Wireless window multisensor in the rebate with battery

Wireless window multisensor in the rebate with battery (lifetime several years) 135 x 18 x 9 mm, light grey. With intelligent burglary detection in mode 1 and 2 (locking monitoring). An alarm signal is sent when the window is opened at the locked and tilted position. Fixing by screwing in the window frame, between frame and sash on PVC or wooden doors and windows, in accordance with the manual.



mTronic	light grey	30000033	126,00
----------------	------------	-----------------	---------------

REMOTE CONTROLS AND FURTHER SENSORS HAND-HELD TRANSMITTERS / OTHER SENSORS

Type	Color	Art. No.	€/pc.
------	-------	----------	-------



FFGB-hg (EIMSIG)



Wireless window contact + glass break sensor Eimsig with battery

Wireless window contact + glass break sensor Eimsig with battery (lifetime several years) 135 x 26 x 9 mm, light grey. With intelligent burglary detection. Recognizes open/closed/tilted/locked and glass vibration. An alarm signal is sent when the window is opened at the locked or tilted position. Fixing by screwing in the window frame, between frame and sash on PVC or wooden doors and windows, in accordance with the manual.

More informations:



<http://eltako.com/redirect/FFGB-hg>

Type	Color	Art. No.	€/pc.
------	-------	----------	-------

FFGB-hg	light grey	30000473	192,10
---------	------------	----------	--------

REMOTE CONTROLS AND FURTHER SENSORS HAND-HELD TRANSMITTERS / OTHER SENSORS

Type	Color	Art. No.	€/pc.
------	-------	----------	-------

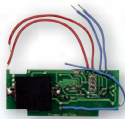

More informations:



<http://eltako.com/redirect/FSMTB>

FSMTB



Wireless transmitter module for key switches and industrial pushbuttons, with battery. Battery life-time 3-5 years. No standby loss. 65 mm long, 28 mm wide and 8 mm deep.

This radio transmitter module is suitable, among other things, for key switches NICE EKSEU (surface-mounted) and industrial pushbuttons EATON M22-DG-X1/KC11/I (surface-mounted). The wireless transmitter module is placed in the box according to the operating instructions and connected to the terminals with wires. No external power supply required. An internal 3 V CR2032 battery supplies power for several years. To activate the battery supply, simply pull out the insulating strip. The wireless transmitter module transmits 2 evaluable signals that are taught into the wireless actuators. It can be taught encrypted into all encryptable actuators of the 61, 62 and 71 Series and into the FAM14.

FSMTB		30000604	71,10
-------	--	----------	-------



More informations:



<http://eltako.com/redirect/FIW-USB>

FIW-USB



Wireless infrared converter with USB port for the universal remote control Logitech Harmony Touch (available from specialist retailers). Only 0.05 watt standby loss.

With a special Eltako FIW data record, the infrared signals are converted into wireless telegrams by a wireless infrared converter FIW-USB and transmitted to the Eltako wireless network. Either connect to a device with power supply to the USB socket or use a USB charger for mains voltage. USB plug Type A with 2 m connecting cable.

FIW-USB	black	30000387	99,20
---------	-------	----------	-------

Type	Color	Art. No.	€/pc.
------	-------	----------	-------



FPE-1



Wireless position switch, blue, without battery or wire



FVST
Wireless encryption plug



More informations:



<http://eltako.com/redirect/FPE-1>

Wireless position switch with energy generator 48 x 32 x 11.5 mm, blue. Generates the power for wireless telegrams itself when the lever is pressed, therefore there is no battery, no connecting wire and no standby loss.

When pressing the operating lever a wireless telegram Data (hex) 0x10 is sent and when releasing Data (hex) 0x00 is sent, like a wireless pushbutton. For more than 100.000 switching cycles, replaceable compression spring.

FPE-1	blue	30000398	70,00
FVST	black	30000015	5,30



AIR



IR scanner for energy meters data gateway

Infrared scanner with fixing magnet for electronic domestic supply meter eHZ for wireless energy meter data gateway FSDG14.

More informations:



<http://eltako.com/redirect/AIR>

AIR		30000970	111,10
-----	--	----------	--------

OTHER

WIRELESS SMALL ACTUATOR SMART VALVE FKS-SV AND MULTI SENSOR MS

Type	Color	Art. No.	€/pc.
------	-------	----------	-------



FKS-SV



Wireless small actuator Smart Valve for radiators. Without battery and wire. With thermic Energy Harvesting.



Bidirectional wireless with EnOcean protocol EEP A5-20-01.

Function: The actuator obtains its power supply from the temperature difference ($\Delta T > 4K$) between the radiator and the room. The internal storage device prevents power supply bottlenecks needed to run the actuator.

Applications: The actuator is designed both for use in private homes and in industrial premises. In rooms that are seldom heated, it may be necessary to recharge the device via the micro-USB.

FKS-SV	silver	30000413	185,40
--------	--------	----------	--------

Type	Color	Art. No.	€/pc.
------	-------	----------	-------



MS



The MS multi sensor sends the current weather details, including brightness (from three points of the compass), wind, rain and frost, to the weather data transmitter module FWS61-24V DC connected in series once per second. Opaque. L x W x H = 118 x 96 x 77 mm. A power supply unit WNT61-24VDC/10W is required for the power supply.

More informations:



<http://eltako.com/redirect/MS>

The evaluation is made with controllers, the wireless multifunction sensor relay FMSR14, the actuators FSB14 and FSB71.

MS	white	20000084	309,20
FWS61-24V DC		30000305	79,60
WNT61-24VDC/10W		61000265	47,20

ROCKERS AND DOUBLE ROCKERS E-DESIGN55 LASER ENGRAVED

Please always also indicate the engraving number according to the following list of pictograms











For any laser engraving order, please specify the type of your pushbutton, remote control or handheld transmitter, the engraving number and also if you need a single or double rocker. Rockers and double rockers for pushbuttons are available on pages 5-44 to 5-46.

The additional title +2P will do for each arrow top (up) and bottom (down).

The additional title +I0 will do for I (=on) top and 0 (=off) down.

The additional title +OI will do for 0 (=off) top and I (=on) down.

Rockers and double rockers in E-Design55 are available in the colors -am (anthracite mat), -pg (polar white glossy), -pm (polar white mat) and -wg (pure white glossy).

	LGI	Laser engraving individually, create new pictogram	Art. No. 30000980	12,20 €/pc.
	W-FIT55E	Rocker for wireless pushbutton E-Design55, -am/-pg/-pm/-wg	Art. No. 30055949	8,00 €/pc.
	W-F2T55E	Rocker for wireless pushbutton and wireless pushbutton with battery in E-Design55, -am/-pg/-pm/-wg	Art. No. 30055966	8,00 €/pc.
	W-F2T55E/10	10x Rocker for wireless pushbutton and wireless pushbutton with battery in E-Design55		
		-am anthacite mat	Art. No. 30055971	15,50 €/pc.
		-pg polar white glossy	Art. No. 30055972	15,50 €/pc.
		-pm polar white mat	Art. No. 30055973	15,50 €/pc.
		-wg pure white glossy	Art. No. 30055970	15,50 €/pc.
	W-F2T55E-am+2P	Rocker for wireless pushbutton and wireless pushbutton with battery in E-Design55, arrow top (up) and bottom (down), am	Art. No. 30055969	8,00 €/pc.
	W-F2T55E-wg+2P	Rocker for wireless pushbutton and wireless pushbutton with battery in E-Design55, arrow top (up) and bottom (down), wg	Art. No. 30055967	8,00 €/pc.
	DW-F4T55E	Double rocker for wireless pushbutton and wireless pushbutton with battery in E-Design55, -am/-pg/-pm/-wg	Art. No. 30055952	8,80 €/pc.
	DW-F4T55E/10	10x Double rocker for wireless pushbutton and wireless pushbutton with battery in E-Design55		
		-am anthacite mat	Art. No. 30055956	20,60 €/pc.
		-pg polar white glossy	Art. No. 30055958	20,60 €/pc.
		-pm polar white mat	Art. No. 30055959	20,60 €/pc.
		-wg pure white glossy	Art. No. 30055957	20,60 €/pc.
	DW-F4T55E-am+2P	Double rocker for wireless pushbutton and wireless pushbutton with battery in E-Design55, arrow top (up) and bottom (down), am	Art. No. 30055955	8,80 €/pc.
	DW-F4T55E-wg+2P	Double rocker for wireless pushbutton and wireless pushbutton with battery in E-Design55, arrow top (up) and bottom (down), wg	Art. No. 30055954	8,80 €/pc.

ROCKERS AND DOUBLE ROCKERS FOR PUSHBUTTONS, SWITCHES, REMOTE CONTROLS AND HAND-HELD TRANSMITTERS LASER ENGRAVED - Please always also indicate the engraving number according to the following list of pictograms

For any laser engraving order, please specify the type of your pushbutton, remote control or handheld transmitter, the engraving number and also if you need a single or double rocker. Rockers and double rockers for pushbuttons are available on pages 5-44 to 5-46.

The additional title +2P will do for each arrow top (up) and bottom (down).







The additional title +I0 will do for I (=on) top and 0 (=off) down.

The additional title +OI will do for 0 (=off) top and I (=on) down.

5-42

	LGI	Laser engraving individually, create new pictogram	Art. No. 30000980	12,20 €/pc.
	W-FMT55/2	Rocker for wireless mini pushbutton, rw/wg	Art. No. 30000957	8,00 €/pc.
	DW-FMT55/4	Double rocker for wireless mini pushbutton, rw/wg	Art. No. 30000958	8,80 €/pc.
	W-FT4B-	Rocker for wireless pushbutton 45x45mm, Belgian design, cr/na/nw	Art.-Nr. 30000965	8,00 €/St.
	DW-FT4B-	Double rocker for wireless pushbutton 45x45mm, Belgian design, cr/na/nw	Art.-Nr. 30000964	8,80 €/St.
	W-FT4CH	Rocker for wireless pushbutton Swiss Design, hg/sz/w	Art. No. 30000959	8,00 €/pc.
	DW-FT4CH	Double rocker for wireless pushbutton Swiss Design, hg/sz/w	Art. No. 30000963	8,80 €/pc.
	W-FT4F	Rocker for wireless pushbutton 63 x 63 mm, am/pg/pm/rw/wg	Art. No. 30000951	8,00 €/pc.
	DW-FT4F	Double rocker for wireless pushbuttons 63 x 63 mm, am/pg/pm/rw/wg	Art. No. 30000952	8,80 €/pc.
	W-FT55	Rocker for wireless pushbutton 55x55 mm, ws/rw/wg/sz/an/al	Art. No. 30000953	8,00 €/pc.
	DW-FT55	Double rocker for wireless pushbuttons 55x55 mm, ws/rw/wg/sz/an/al	Art. No. 30000954	8,80 €/pc.

ROCKERS AND DOUBLE ROCKERS FOR PUSHBUTTONS, SWITCHES, REMOTE CONTROLS AND HAND-HELD TRANSMITTERS LASER ENGRAVED - Please always also indicate the engraving number according to the following list of pictograms

	W-FT55R	Rocker for wirel. pushbuttons 55x55 mm for Busch Reflex and Duro, white/alpine white	Art. No. 30000967	8,00 €/pc.
	DW-FT55R	Double rocker for wirel. pushbuttons 55x55 mm for Busch Reflex and Duro, white/alpine white	Art. No. 30000968	8,80 €/pc.
	DW-W2T55	Double rocker for rocker pushbutton, pure white glossy	Art. No. 30000977	7,60 €/pc.
	W-WT/WS55	Rocker for rocker pushbutton and rocker switch, ws/rw/wg/sz/an/al	Art. No. 30000975	8,00 €/pc.
	DW-FF8	Double rocker for wireless remote control, anthracite-soft paint	Art. No. 30000962	8,80 €/pc.
	W-FHS/FMH2	Rocker for wireless handheld transmitters and mini handheld transmitters, ws/rw/wg/sz/an	Art. No. 30000960	8,00 €/pc.
	DW-FHS/FMH4	Double rocker for wireless handheld transmitters FMH4, ws/rw/wg/sz/an	Art. No. 30000961	8,80 €/pc.

OVERVIEW PICTOGRAMS FOR LASER ENGRAVINGS

5-44

						
1	2	3	4	5	6	7
						
8	10	11	12	13	14	15
						
16	17	18	20	21	22	23
						
24	25	26	27	28	29	30
						
31	32	33	34	35	36	37
						
38	39	40	41	42	43	44
						
45	46	47	48	49	50	51
						
52	53	54	55	56	57	59
						

OVERVIEW PICTOGRAMS FOR LASER ENGRAVINGS



OVERVIEW PICTOGRAMS FOR LASER ENGRAVINGS



For any laser engraving order, please specify the type of your pushbutton, remote control or handheld transmitter, the engraving number and also if you need a single or double rocker. Rockers and double rockers for pushbuttons are available on pages 5-49 to 5-51.

The additional title +2P will do for each arrow top (up) and bottom (down). The additional title +I0 will do for I (=on) top and 0 (=off) down.

The additional title +O1 will do for 0 (=off) top and I (=on) down.

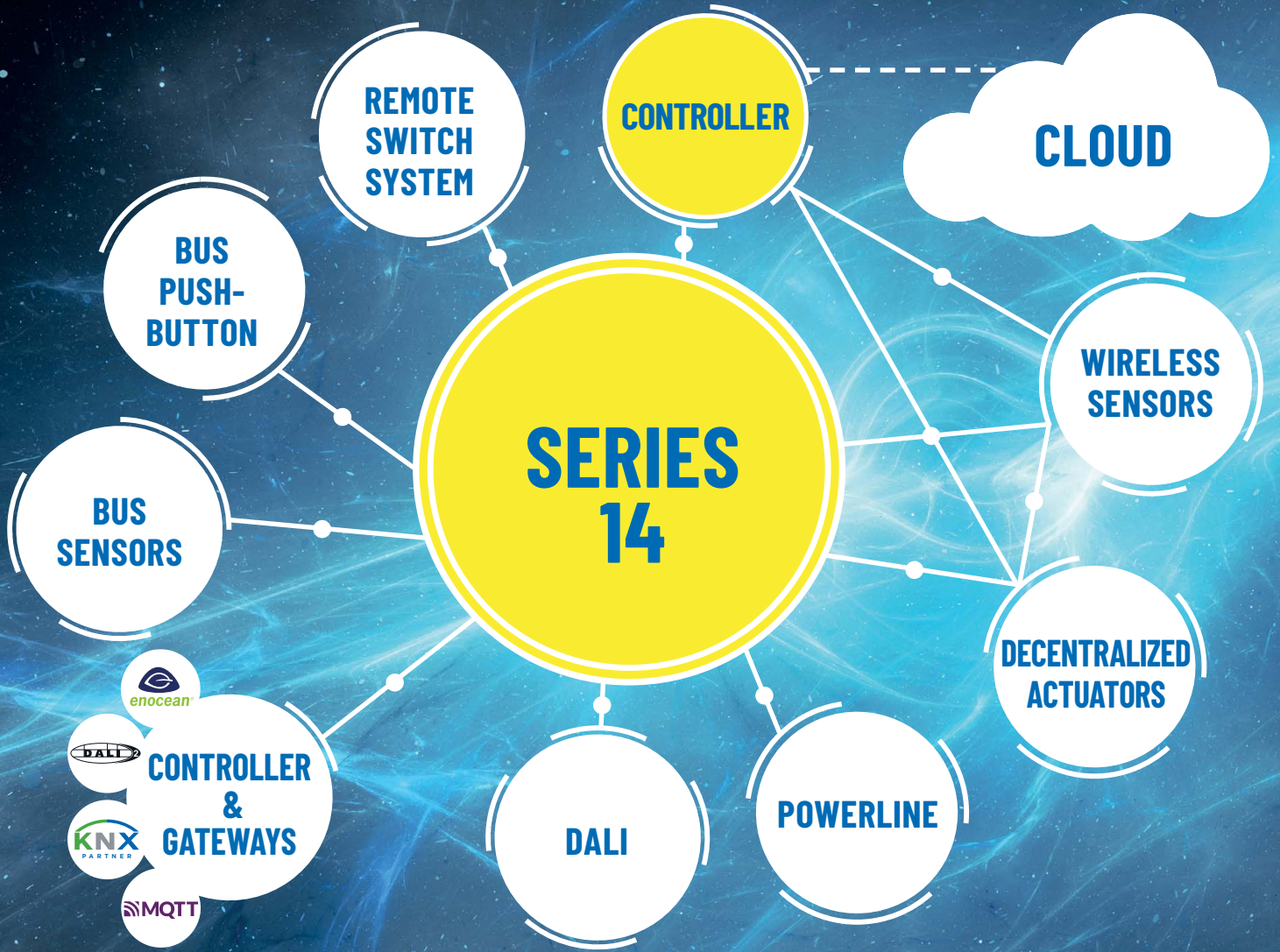

**MiniSafe2
FGW14WL-IP**



WE CONNECT AND CONTROL DIFFERENT WORLDS.

Our Series 14 can communicate with all important standards such as EnOcean, ZigBee, KNX, DALI and MQTT via the various controllers and gateways and can be controlled and automated using our controller via app. Ideally, the app runs on an iPad that is plugged into one of our docking stations.

Eltako - The Wireless Building. The basis with sensors and actuators	6-2
Eltako - The Wireless Building for all	6-3
NEW Controller MiniSafe2 and infrared transmitter IRT3	6-4
NEW Controller MiniSafe2-REG for installation on DIN rail with external antenna and infrared transmitter IRT3	6-5
Controller wibutler pro (2. Gen.) WP2	6-6
NEW RS485 bus energy meters MQTT gateway via WLAN FGW14W-IP and RS485 bus energy meters MQTT gateway via WLAN or LAN FGW14WL-IP	6-7
RS485 bus DALI gateway FDG14	6-8
EnOcean KNX gateways KNX ENO 626 and KNX ENO 636	6-9
Wall Docking station for iPads with charging function OnWall	6-10
In-wall docking station for iPads with charging function InWall-10	6-10
Exchange set lightning on USB-C	6-10

THE ELTAKO WIRELESS BUILDING IS THE WIRELESS NETWORK FOR BUILDINGS OF ANY SIZE.

6-2

The wireless pushbuttons, wireless sensors and wireless actuators from Eltako work perfectly together and control, regulate and switch all areas in the building. Eltako software and hardware for visualisation and control.

- The most modern Eltako controller is the MiniSafe2, which with its compact construction and elegant design fits into any living room. Controlled via the GFA5 app, most of the Eltako actuators and sensors can be integrated, controlled and automated with tasks and scenes. Updates can be imported and backups can be outsourced. Cloud services such as Amazon Alexa and Google Assistant are supported.
- Even when the Smart Home controller is switched off - e.g. during its maintenance - all pushbutton, sensor and actuator functions in the building are retained.

Without **Eltako sensors and actuators** no information or control commands can be sent over the wireless network. They form the basis for the **Eltako Wireless Building** and of course they operate without a controller if there is no requirement for centralised building monitoring, centralised building control or visualisation.

Eltako sensors for switch commands, temperature, brightness, motion, humidity and air quality run partly without external power supply **completely self-sufficient**.

Batteryless and cordless **Eltako wireless pushbuttons** and hand-held transmitters generate their own power requirements for wireless telegrams when operated. Many **Eltako sensors** generate their power requirements from a solar cell and save excess energy from daylight to storage capacitors so that there is sufficient energy for troublefree functioning in the dark.

Some of these sensors and solar cells can be made 'winterproof' with additional batteries. Further Eltako sensors have a higher power requirement which they cannot generate themselves and therefore require an external power supply.

Eltako actuators are the backbone of the **Eltako Wireless Building**. They only evaluate directly addressed wireless telegrams in order to switch or control any number of consumers in the building. Many have a **bidirectional function**. This allows them to send back their switch states to the controller or displays or directly initiate other functions via actuators. In addition, these actuators may also function as repeaters.

Of course there are specific actuators for either centralised or decentralised installation. If the **Eltako RS485 bus** is installed centrally with rail mounted devices in switch cabinets, a **wireless antenna module FAM14** is used to communicate with the actuators. The RS485 bus can also be used composite or without wireless by means of the **Eltako remote switch system FTS**.

The Eltako Wireless Building uses all Eltako wireless components in an ingenious way and can be installed even in small installations. The components are all downwards-compatible!

All sensors and actuators communicate within the Eltako wireless network by means of telegrams using the world-wide standard of the **EnOcean Alliance**. The batteryless and cordless wireless modules in the Eltako wireless pushbuttons are produced by **EnOcean** in Germany, the wireless microchips in the other sensors and actuators in Europe.

Eltako therefore develops and manufactures **all** the offered sensors and actuators with the Eltako logo. These are of course compatible with all products made by other manufacturers within the enormous international EnOcean family.

A SMALL SELECTION OF OUR WIRELESS SENSORS AND ACTUATORS

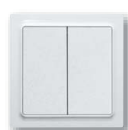

F4T55E
Wireless 4-way push-button 55 x 55 mm without battery or wire



F1T55E
Wireless 1-way push-button 55 x 55 mm without battery or wire

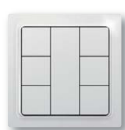

F6T55EB
Wireless 6-way push-button 55 x 55 mm without wire



FBH55ESB
Wireless motion/brightness sensor with solar cells 55 x 55 mm without wire



FTR55ESB-
Wireless temperature controller with solar cells 55 x 55 mm without wire



FMHIW-wg/rot
Mini hand-held transmitter for calling systems, without battery or wire



FFD
Wireless remote control with display



FSR14-2x
Wireless impulse switch with 2 channels

FUD14
Wireless dimming actuator 400W



FSR61NP
Wireless Impulse switch with integr. relay function. 1 NO contact not potential free



FUD61NP
Wireless universal dimmer switch without N

YOU CAN START SMALL WITH ELTAKO WIRELESS BUILDING.

An actuator with two batteryless and wireless pushbuttons is already a very elegant solution to the problem of missing pushbuttons: The old light switch is replaced by a wireless actuator preceded by a wireless pushbutton. Up to 32 other wireless pushbuttons can be fitted. Then of course, the wireless actuator can also be a wireless dimming actuator.

At the other end of the unlimited and wide spectrum of possibilities with the Eltako Wireless Building, there are networked skyscrapers with hundreds of wireless sensors and wireless actuators, in groups or grouped floor by floor, monitored, controlled and visualised.

6-3

THE 3 STAGES ON THE ELTAKO WIRELESS BUILDING SUCCESS LADDER.

STAGE 1

Decentralized actuators + sensors

A few wireless sensors and wireless actuators to improve or expand an existing installation. Generally with actuators installed decentrally.



STAGE 2

Decentralized / centralized actuators + sensors Optional and recommended: Controller (MiniSafe2)

Some wireless sensors and wireless actuators when renovating or building a new building, with central monitoring and control. For convenient control and visualization supplemented by smart docking stations with tablets.

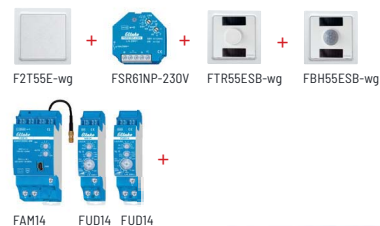

STAGE 3

Decentralized and centralized wireless actuators + Wireless sensors + Gateways +

Optional: Controllers (MiniSafe2) + docking stations

Centralized and decentralized wireless sensors and wireless actuators in one building with central monitoring, control, automation and visualisation via common end devices and voice services. Compatibility through gateways to PC interfaces, Powerline, DALI, MQTT and much more. Supplemented by smart docking stations and tablets for convenient operation and visualization.

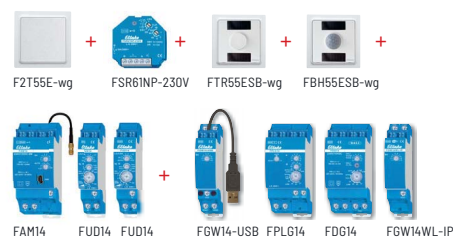

CONTROLLER MINISAFE2 AND INFRARED TRANSMITTER IRT3



MiniSafe2
Controller

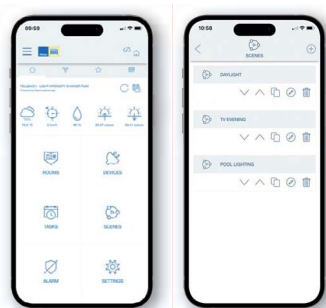

Eltako GFA5 app

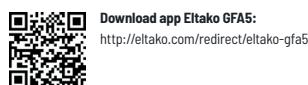

Download app Eltako GFA5:
<http://eltako.com/redirect/eltako-gfa5>



Manuals and documents in further
languages:
<http://eltako.com/redirect/MiniSafe2>

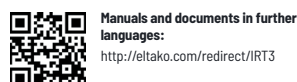

Manuals and documents in further
languages:
<http://eltako.com/redirect/IRT3>

MiniSafe2



The MiniSafe2 is the smallest, universally applicable controller from Eltako. The central control unit ensures that EnOcean compatible sensors and actuators can be conveniently and centrally controlled using the GFA5 app and voice commands.

This allows light, shading, air conditioning, security components, and much more to be easily and flexibly combined with one another in order to transform any living environment into a professional smart home in no time at all.

The basic equipment includes app-based automation, update and backup options. Migration from older Eltako controllers is possible.

The MiniSafe2 can basically be operated offline and locally, internet access is not required for this.

Remote access and the cloud connection can optionally be activated during operation.

An internet connection and a WiFi network are required for setup.

TECHNICAL DATA

Dimensions	H x W x D: 90 x 90 x 20 mm
Operating temperature	Min. 0 °C to max. +40 °C
Weight	approx. 80 g
Power supply	5 V DC / 1.5 A, 100 V - 240 V AC, 50/60 Hz
Power consumption	1.3 watt
Processor	84 MHz ARM® Cortex® - M4, 512 Kbyte Flash, 96 KB SRAM
Network	WLAN IEEE 802.11 / b/g/n 2.4 GHz
Wireless transceiver	1 x EnOcean 868 MHz, 1 x 868 MHz
Infrared (IR)	Integrated IR receiver 38 KHz and transmitter unit (36 - 455 KHz)
Connection of external IR transmitter	1 x 3.5 mm jack socket, addressable (rear)

MiniSafe2	Controller	Art. No. 30000075	315,10 €/pc.*
-----------	------------	-------------------	---------------

IRT3

NEW

Infrared transmitter with 3 m cable and 3.5 mm jack plug.

To be connected to the MiniSafe2 for use in home automation. For controlling devices with an IR interface, e.g. air conditioners, amplifiers, Xbox One, HD-DVR, stereo receivers, TV sets, SAT TV receivers, CD players, DVD players, Blu-Ray players or other components.

IRT3	Infrared transmitter with 3 m cable and 3.5 mm jack plug	Art. No. 30000100	6,00 €/pc.
------	--	-------------------	------------

CONTROLLER MINISAFE2-REG FOR INSTALLATION ON DIN RAIL WITH EXTERNAL ANTENNA AND INFRARED TRANSMITTER IRT3



90 mm

90 mm

MiniSafe2-REG
Ccontroller



31 mm



including an external EnOcean
antenna FA250

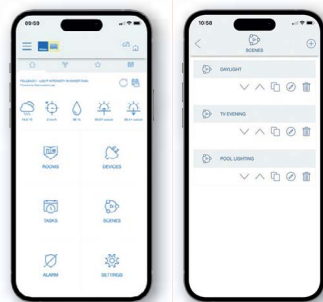

Eltako GFA5 app



Download app Eltako GFA5:
<http://eltako.com/redirect/eltako-gfa5>



Manuals and documents in further
languages:
[http://eltako.com/redirect/
MiniSafe2-REG](http://eltako.com/redirect/MiniSafe2-REG)



Manuals and documents in further
languages:
<http://eltako.com/redirect/IRT3>

MiniSafe2-REG



Controller for installation on DIN rail.

The MiniSafe2-REG is the smallest, universally applicable controller from Eltako. The central control unit ensures that EnOcean compatible sensors and actuators can be conveniently and centrally controlled using the GFA5 app and voice commands. This allows light, shading, air conditioning, security components, and much more to be easily and flexibly combined with one another in order to transform any living environment into a professional smart home in no time at all.

The basic equipment includes app-based automation, update and backup options. Migration from older Eltako controllers is possible.

The MiniSafe2-REG can basically be operated offline and locally, internet access is not required for this. Remote access and the cloud connection can optionally be activated during operation.

An internet connection and a WiFi network are required for setup.

The scope of supply includes a power supply unit, an external black antenna, a black radio antenna with a 250 cm cable FA250 to increase the EnOcean wireless range and a DIN rail mount.

TECHNICAL DATA	
Dimensions	H x W x D: 90 x 90 x 31 mm
Operating temperature	Min. 0 °C to max. +40 °C
Weight	approx. 100 g
Power supply	5 V DC/1.5 A, 100 V-240 V AC, 50/60 Hz
Power consumption	1.3 watt
Processor	84 MHz ARM® Cortex® - M4, 512 Kbyte Flash, 96 KB SRAM
Network	WLAN IEEE 802.11 /b/g/n 2.4 GHz
Wireless transceiver	1x EnOcean 868 MHz, 1x 868 MHz
Infrared (IR)	Integrated IR receiver 38 KHz and transmitter unit (36 - 455 KHz)
Connection of external IR transmitter	1 x 3.5 mm jack socket, addressable (rear)

MiniSafe2-REG	Controller for installation on DIN rail	Art. No. 30000076	425,30 €/pc.*
Optional: HDR-30-5	Switching power supply unit 5 V/15 W for MiniSafe2-REG	Art. No. 30000940	56,00 €/pc.

IRT3



Infrared transmitter with 3 m cable and 3.5 mm jack plug.

To be connected to the MiniSafe2 for use in home automation. For controlling devices with an IR interface, e.g. air conditioners, amplifiers, Xbox One, HD-DVR, stereo receivers, TV sets, SAT TV receivers, CD players, DVD players, Blu-Ray players or other components.

IRT3	Infrared transmitter with 3 m cable and 3.5 mm jack plug	Art. No. 30000100	6,00 €/pc.
------	--	-------------------	------------

CONTROLLER WIBUTLER PRO (2nd GEN.)



wibutler pro 2
Controller

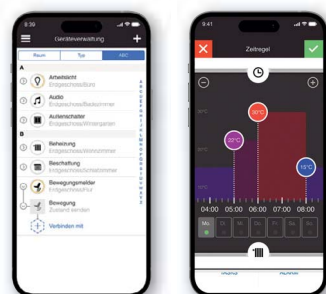

wibutler app Eltako Edition

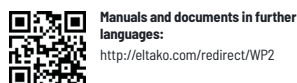

Manuals and documents in further languages:
<http://eltako.com/redirect/WP2>

WP2



wibutler pro (2nd gen.) Controller with app Eltako Edition. The wibutler pro (2nd gen.) is a future-proof center for building control, energy regulation and alarm messages. Due to its high flexibility, it offers a wide range of possible applications for new buildings and existing properties. It combines sustainable communication standards with variable installation options and high data protection standards. The wibutler pro (2nd gen.) is compatible with more than 300 devices from over 30 different top brands and securely networks them with each other. The cross-manufacturer and cross-trade optimization raises building services to a whole new level. Smart home server.

TECHNICAL SPECIFICATIONS	
Dimensions	(LxWxH) 13,2 x 13,2 x 2,6 cm
Power supply	input 5 V/3 A DC, power supply unit 100 V-240 V AC, 50/60 Hz
Interfaces / Connectors - EU	1 x Ethernet RJ45, 2 x 2.0 USB port
Processor	1 GHz CPU Cortex-A7 Dual Core
Network	WLAN IEEE 802.11 /b/g/n 2.4 GHz
Wireless protocols	EnOcean/868.3 MHz, ZigBee 3.0, Matter (possible in principle), TCP/IP, Low power radio/2.4 GHz, WLAN/802.11 b/g/n 2.4 GHz
Hard disk	integrated 4 GByte eMMC; RAM: 1 GByte RAM
Color	white

WP2	wibutler pro (2nd gen.) Controller	Art. No. 30000077	410,30 €/pc.*
-----	---------------------------------------	-------------------	---------------

THE WIBUTLER CONCEPT

wibutler is a manufacturer independent Professional Smart Home solution to simplify people's everyday lives. The solution combines products of various manufacturers and needs only a single app for users to control, combine and automate all products. Using time and automation rules defined especially for this application, wibutler can assume tasks and act according to its owner's wishes.

wibutler pro

The core of the solution is the wibutler pro 2 Controller. Thanks to multiple wireless standards (EnOcean, ZigBee 3.0, WLAN), it is extremely compatible and is capable of networking products irrespective of the manufacturer. The controller unifies the corresponding wireless standards and thus makes it possible to network products from different standards, manufacturers and industries. The wibutler pro can be used offline, which is why an internet connection is not necessary.

wibutler app Eltako Edition

It takes only a few clicks to network, automate and control smart products using the wibutler app Eltako Edition. The entire house is networked and controlled by a single app.

This is how it works:

- **Automation rules:** The wibutler organises devices to work in a team. Devices react by means of if/then rules to movements and actions such as the opening or closing of windows, doors or drawers.
- **Time control:** wibutler uses time rules to learn repetitive tasks which must be executed at particular times.
- **Remote control:** With the wibutler, the status of devices can be displayed and changed conveniently via smartphones and tablets while on the move.
- **Consumption logs:** The wibutler measures consumptions and shows where is the greatest savings potential.
- **Profiles:** defined rules are assigned to profiles (e.g. , 'Home Day/ Night', 'Away' and 'Holiday'). With one click of a profile pushbutton you can change the entire house to the mode you require (e.g. 'Away': All OFF, alarm system and presence simulations ON).

RS485 BUS ENERGY METERS MQTT GATEWAY VIA WLAN FGW14W-IP AND RS485 BUS ENERGY METERS MQTT GATEWAY VIA WLAN OR LAN FGW14WL-IP



Function rotary switch

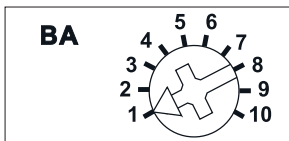

Standard setting ex works.



Manuals and documents in further languages:
<http://eltako.com/redirect/FGW14W-IP>

Housing for operating instructions
GBA14 page 1-49.



Function rotary switch

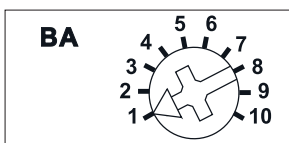

Standard setting ex works.



Manuals and documents in further languages:
<http://eltako.com/redirect/FGW14WL-IP>

Housing for operating instructions
GBA14 page 1-49.

FGW14W-IP



**Gateway with IP interface for Series 14 energy meters via WLAN.
Only 0.8 watt standby loss.**

Modular device for DIN-EN 60715 TH35 rail mounting.

1 module = 18 mm wide, 58 mm deep.

The gateway is only 1 module wide: For operation, the gateway must be integrated into a WLAN.

The WLAN connection uses the 2.4 GHz frequency band.

Connection to the Eltako-RS485 bus. Bus cross wiring and power supply with jumper.

Operation in conjunction with FAM14 or FTS14KS.

The IP connection is via WLAN. The gateway transmits data from any Eltako electricity meter on the RS485 bus using the MQTT protocol. The data is transferred from the RS485 bus to any external MQTT broker. For more details on MQTT see e.g. <https://mqtt.org/>

The data is encoded according to the EnOcean/IP format, see: www.enocean-alliance.org/specifications/

Configurations and updates are made via the Eltako Connect app or via a web interface.

A REST API is available on the device's online product page.

FGW14W-IP	RS485 Bus energy meters MQTT Gateway via WLAN; MQTT and REST-API	Art. No. 30014041	92,40 € / pc.
------------------	--	--------------------------	----------------------

FGW14WL-IP



**Gateway with IP interface for Series 14 energy meters via WLAN or LAN.
Only 0.8 watt standby loss.**

Modular device for DIN-EN 60715 TH35 rail mounting.

1 module = 18 mm wide, 58 mm deep.

The gateway is only 1 module wide: For operation, the gateway must be integrated into a WLAN or LAN.

The WLAN connection uses the 2.4 GHz frequency band. The LAN connection is via RJ45 connector with 10/100Base-T.

Connection to the Eltako-RS485 bus. Bus cross wiring and power supply with jumper.

Operation in conjunction with FAM14 or FTS14KS.

The Hold terminal is connected to the FAM14 or the FTS14KS.

The IP connection is via LAN or WLAN. The gateway transmits data from any Eltako electricity meter on the RS485 bus using the MQTT protocol. The data is transferred from the RS485 bus to any external MQTT broker. For more details on MQTT see e.g. B. <https://mqtt.org/>

The data is encoded according to the EnOcean/IP format, see: www.enocean-alliance.org/specifications/

Configurations and updates are made via the Eltako Connect app or via a web interface.

A REST API is available on the device's online product page.

FGW14WL-IP	RS485 Bus energy meters MQTT Gateway via WLAN or LAN; MQTT and REST-API	Art. No. 30014051	106,50 € / pc.
-------------------	---	--------------------------	-----------------------

RS485 BUS DALI GATEWAY FOR RAIL MOUNTING FDG14

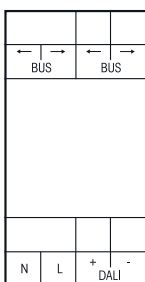
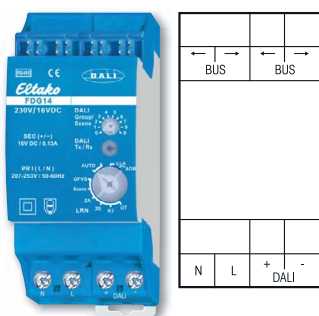

FDG14



**RS485 bus DALI gateway for DIN-EN 60715 TH35 rail mounting, bidirectional.
Only 1 watt standby loss.**

Modular device for DIN-EN 60715 TH35 rail mounting. 2 modules = 36 mm wide, 58 mm deep.

Connection to the Eltako-RS485 bus. Bus cross wiring and power supply with jumper.

Operation in conjunction with FAM14.

Power supply 230 V at terminals N and L.

16 V DC/130 mA can be connected to the DALI terminals +/- for up to 64 DALI devices.

The gateway FDG14 controls DALI devices with EnOcean wireless transmitters via the FAM14.

As of production week 14/16 **Groups 0-15** can be controlled and the **broadcast command** can be sent. In addition **DALI scenes 0-15** can be controlled.

DALI installations, which are to be fully controlled with the FDG14, must be configured in groups 0-15.

FDG14 internally saves the dimming value for each of the groups 0-15 and supplies this value as feedback.

The same feedback telegrams are generated as for an FUD14. The FDG14 occupies 16 BR14 device addresses.

The feedbacks of the device addresses correspond to the dimming values of the DALI groups 0-15 in ascending order. Feedbacks can be converted by the PCT14 for each individual group of dimming value telegrams

(%) to pushbutton telegrams (ON/OFF). Feedbacks can then control BR14 actuators. The FDG14 fulfils the

function of the DALI master and the DALI power supply. The rotary switches can only teach in pushbuttons

for groups 0-8 and DALI scenes 0-9. Activation telegrams for groups 9-15 and scenes 10-15 are only possible

by entries in PCT14.

As of Production Week 30/19, the FDG14 can be used as a single-channel device '**FDG14-Broadcast**'. This is defined when the device address is issued.

Important: Wireless pushbuttons always need to be double-clicked when they are taught-in manually in the FDG14. CLR only needs a single click.

A direction pushbutton or universal pushbutton with identical ID and identical pushbutton can be taught in several times in different groups. The group last selected is always valid. Therefore, a pushbutton can either switch only one group or broadcast to all groups.

One FBH per group can also be taught in. With a manual teach-in this always acts dependent on brightness.

With PCT14 you can also set the brightness threshold.

The delay time for switch-off after no motion is detected can be set together in minutes (1 ... 60) for the FBH devices of all groups. The default is 3 minutes.

Function rotary switches

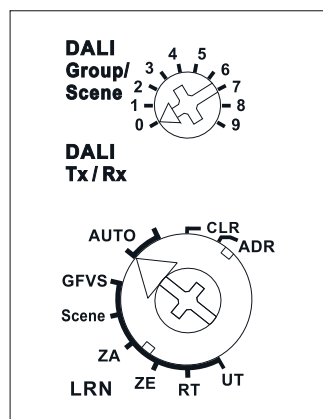

Standard setting ex works.

Further settings can be made using the PC Tool PCT14 (see page 1-5).



Manuals and documents in further languages:
<http://eltako.com/redirect/FDG14>

Housing for operating instructions
GBA14 page 1-49.

FDG14	RS485 bus DALI gateway for rail mounting	Art. No. 30014047	95,60 €/pc.
--------------	--	--------------------------	--------------------

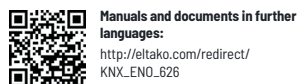

KNX ENO 626



Bidirectional gateway between EnOcean wireless and KNX bus with 8 channels for flush mounting.

The KNX ENO 626 secure acts as a bidirectional gateway between EnOcean Wireless and the KNX/EIB bus. Control commands and measured values can be transmitted by EnOcean wireless sensors to the KNX bus, for example to control KNX actuators. Similarly, EnOcean wireless actuators can be controlled by KNX. The KNX ENO 626 secure from Weinzierl allows encrypted communication with security compatible EnOcean devices.

The KNX ENO 626 secure has 8 wireless channels and accepts over 100 device profiles (EEP EnOcean Equipment Profile), it allows an easy and secure connection from different EnOcean sensors and actor to a KNX installation.

In addition, the gateway offers logic and control functions and comprises an integrated level 1 wireless repeater.

The purpose of the **repeater function** is to span large distances between sensors and actuators.

Configuration takes place using the KNX ENO tool. Download from www.weinzierl.de.

Flush mounting in a 55 mm flush-mounted box.

6-9

KNX ENO 626	Flush-mounted EnOcean KNX gateway	Art. No. 30000944	323,90 €/pc.
--------------------	-----------------------------------	--------------------------	---------------------

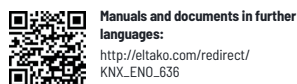

KNX ENO 636



Bidirectional gateway between EnOcean wireless and KNX bus with 32 channels, 81 x 81 x 25 mm.

The KNX ENO 636 secure acts as a bidirectional gateway between EnOcean Wireless and the KNX/EIB bus. Control commands and measured values can be transmitted by EnOcean wireless sensors to the KNX bus, for example to control KNX actuators. Similarly, EnOcean wireless actuators can be controlled by KNX. The KNX ENO 636 secure from Weinzierl allows encrypted communication with security compatible EnOcean devices.

The KNX ENO 636 secure has 32 wireless channels and accepts over 100 device profiles (EnOcean Equipment Profile), it allows an easy and secure connection from different EnOcean sensors and actor to a KNX installation.

In addition the gateway offers logic functions and comprises an integrated level 1 wireless repeater.

The purpose of the **repeater function** is to span large distances between sensors and actuators.

Configuration takes place using the KNX ENO tool. Download from www.weinzierl.de.

Surface mounting in a 55 mm flush-mounted box. Power is supplies over the KNX bus.

KNX ENO 636	Surface mounted EnOcean KNX gateway	Art. No. 30000948	481,20 €/pc.
--------------------	-------------------------------------	--------------------------	---------------------

UNIVERSAL WALL AND FLUSH-MOUNTED DOCKING STATION WITH CHARGING FUNCTION AND EXCHANGE SET LIGHTNING ON USB-C



Manuals and documents in further languages:
<http://eltako.com/redirect/OnWall>



Manuals and documents in further languages:
<http://eltako.com/redirect/InWall-10-sz>

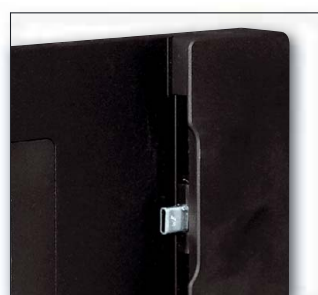

Front connection USB-C



Back connection USB-A



Manuals and documents in further languages:
http://eltako.com/redirect/Austausch-Set_Lightning

Recommended retail prices excluding VAT.

OnWall-



Universal wall docking station with charging function for permanent horizontal installation of an Apple iPad with height-adjustable Lightning or USB-C connector. Removal possible at any time. Surface mounting via a flush-mounted electronics box. Milled from a block of aluminium. External power supply 100-240 V AC to USB included. Dimensions: 140,0 x 220,0 x 18,0 mm.

OnWall-al	Universal wall docking station for all Lightning iPads, with charging function, natural aluminium	Art. No. 30000001	368,50 €/pc.
OnWall-sz	Universal wall docking station for all Lightning iPads, with charging function, black anodized aluminium	Art. No. 30000002	368,50 €/pc.
OnWall/C-al	Universal wall docking station for all USB-C iPads, with charging function, natural aluminium	Art. No. 30000043	399,60 €/pc.
OnWall/C-sz	Universal wall docking station for all USB-C iPads, with charging function, black anodized aluminium	Art. No. 30000044	399,60 €/pc.

InWall-10



In-wall docking station with charging function for permanent vertical or horizontal installation (lock: pre-installed) of an Apple iPad 10,2". In-wall installation box. Aluminium frame and glass cover in black. The glass cover has mini openings for microphone and loudspeaker for use as an intercom system. External power supply 110-240 V AC to USB included. Dimensions: 226,0 x 315,0 x 78,0 mm, flush-mounted dimensions: 215,0 x 305,0 x 78,0 mm.

InWall-10-sz	In-wall docking station for iPads 10,2" with charging function, black anodized aluminium with black glass cover	Art. No. 30000003	394,20 €/pc.
---------------------	---	--------------------------	---------------------

Exchange set lightning on USB-C



USB-C cable with USB-A connector for exchanging lightning to USB-C for OnWall.

Exchange set lightning on USB-C	USB-C cable for exchanging lightning on USB-C for OnWall	Art. No. 30000007	115,70 €/pc.
--	--	--------------------------	---------------------

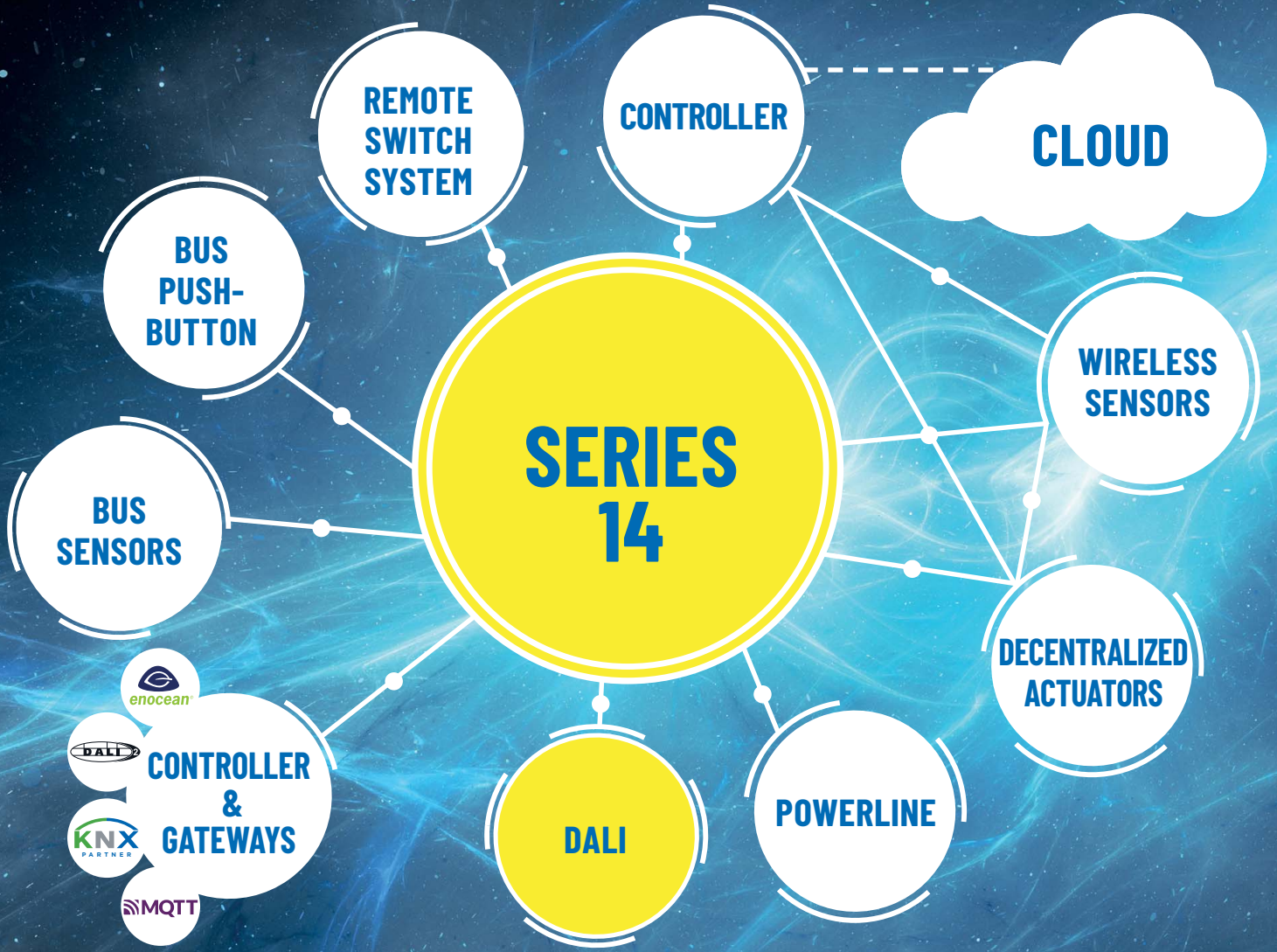

FDG62-230V
DL-1CH-8A
DL-TW-2LT-
16A-DC12+

ELTAKO-DALI
THE PROFESSIONAL LIGHT CONTROL FOR ALL
NEEDS.

The new Eltako DALI product line

Gateways to EnOcean and Series 14

RS485 bus DALI gateway for DIN-EN 60715 TH35 rail mounting [FDG14](#) 7-2

Wireless DALI gateway for flush-mounted box [FDG62-230V](#) and DALI2 bus power supply unit 80 mA for flush-mounted box [DL-N2-80mA](#) 7-3

Wireless DALI gateway for ceiling installation [FDG71L-230V](#) 7-4

1 channel LED dimmer

DALI LED 1 channel dimmer 8 A for flush-mounted box [DL-1CH-8A-DC12+](#) 7-5

NEW DALI2 LED 1 channel dimmer 16 A for ceiling installation [DL-1CH-16A-DC12+](#) 7-6

DALI LED 1 channel DALI LED dimmer 16 A for DIN-EN 60715 TH35 rail mounting [DL-1CH-R16A-DC12+](#) 7-7

Tunable White-Dimmer

DALI LED dimmer 8 A tunable white for flush-mounted box [DL-TW-2LT-8A-DC12+](#) 7-8

NEW DALI 2LED dimmer 16 A tunable white for ceiling installation [DL-TW-2LT-16A-DC12+](#) 7-9

DALI LED dimmer 16 A tunable white for DIN-EN 60715 TH35 rail mounting [DL-TW-2LT-R16A-DC12+](#) 7-10

RGB dimmer (DT8)

DALI LED RGB dimmer 8 A for flush-mounted box (DT8) [DL-RGB-8A-DC12+](#) 7-11

NEW DALI2 LED RGB dimmer 16 A for ceiling installation (DT8) [DL-RGB-16A-DC12+](#) 7-12

DALI LED RGB dimmer 16 A for DIN-EN 60715 TH35 rail mounting (DT8) [DL-RGB-R16A-DC12+](#) 7-13

LED multi-channel dimmer (DT6)

DALI LED 3 channels dimmer 8 A for flush-mounted box (DT6) [DL-3CH-8A-DC12+](#) 7-14

NEW DALI2 LED 3 channels dimmer 16 A for ceiling installation (DT6) [DL-3CH-16A-DC12+](#) 7-15

DALI LED 3 channels dimmer 16 A for DIN-EN 60715 TH35 rail mounting (DT6) [DL-3CH-R16A-DC12+](#) 7-16

DALI LED 4 channels dimmer 8 A for flush-mounted box (DT6) [DL-4CH-8A-DC12+](#) 7-17

NEW DALI2 LED 4 channels dimmer 16 A for ceiling installation (DT6) [DL-4CH-16A-DC12+](#) 7-18

DALI LED 4 channels dimmer 16 A for DIN-EN 60715 TH35 rail mounting (DT6) [DL-4CH-R16A-DC12+](#) 7-19

Switching actuator (DT7)

NEW DALI2 relay module 8 A for flush-mounted box (DT7) [DL-RM8A](#) 7-20

DALI relay module 16 A for DIN-EN 60715 TH35 rail mounting (DT7) [DL-RM16A-HS-WE](#) 7-21

Phase dimmer (DT4)

DALI Phase dimmer 300 W for ceiling installation (DT4) [DL-PD-300W-RLC](#) 7-22

DALI Phase dimmer 300 W for DIN-EN 60715 TH35 rail mounting (DT4) [DL-PD-300W-RLC-HS](#) 7-23

Control units

DALI control unit for controlling the circadian course of daylight for flush-mounted box [DL-CTV](#) 7-24

USB interfaces and tools

DALI commissioning tool [DALI-Cockpit](#) and [DALI-Monitor](#) 7-25

DALI-USB interface for flush-mounted box [DL-USB mini](#) 7-26

DALI-USB interface for DIN-EN 60715 TH35 rail mounting [DL-Flash-USB](#) 7-26

Technical data 7-27

RS485 BUS DALI GATEWAY FOR RAIL MOUNTING FDG14

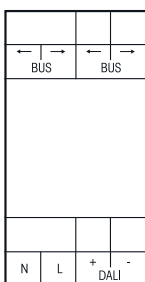
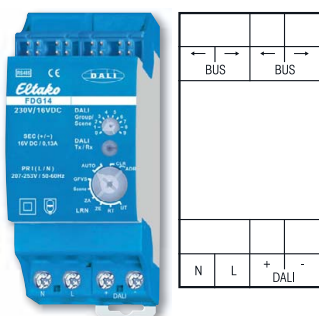

FDG14



**RS485 bus DALI gateway for DIN-EN 60715 TH35 rail mounting, bidirectional.
Only 1 watt standby loss.**

Modular device for DIN-EN 60715 TH35 rail mounting. 2 modules = 36 mm wide, 58 mm deep.

Connection to the Eltako-RS485 bus. Bus cross wiring and power supply with jumper.

Operation in conjunction with FAM14.

Power supply 230 V at terminals N and L.

16 V DC/130 mA can be connected to the DALI terminals +/- for up to 64 DALI devices.

The gateway FDG14 controls DALI devices with EnOcean wireless transmitters via the FAM14.

As of production week 14/16 **Groups 0-15** can be controlled and the **broadcast command** can be sent. In addition **DALI scenes 0-15** can be controlled.

DALI installations, which are to be fully controlled with the FDG14, must be configured in groups 0-15.

FDG14 internally saves the dimming value for each of the groups 0-15 and supplies this value as feedback.

The same feedback telegrams are generated as for an FUD14. The FDG14 occupies 16 BR14 device addresses.

The feedbacks of the device addresses correspond to the dimming values of the DALI groups 0-15 in ascending order. Feedbacks can be converted by the PCT14 for each individual group of dimming value telegrams

(%) to pushbutton telegrams (ON/OFF). Feedbacks can then control BR14 actuators. The FDG14 fulfils the

function of the DALI master and the DALI power supply. The rotary switches can only teach in pushbuttons

for groups 0-8 and DALI scenes 0-9. Activation telegrams for groups 9-15 and scenes 10-15 are only possible

by entries in PCT14.

As of Production Week 30/19, the FDG14 can be used as a single-channel device '**FDG14-Broadcast**'. This is

defined when the device address is issued.

Important: Wireless pushbuttons always need to be double-clicked when they are taught-in manually in the FDG14. CLR only needs a single click.

A direction pushbutton or universal pushbutton with identical ID and identical pushbutton can be taught in several times in different groups. The group last selected is always valid. Therefore, a pushbutton can either switch only one group or broadcast to all groups.

One FBH per group can also be taught in. With a manual teach-in this always acts dependent on brightness. With PCT14 you can also set the brightness threshold.

The delay time for switch-off after no motion is detected can be set together in minutes (1 ... 60) for the FBH devices of all groups. The default is 3 minutes.

Function rotary switches

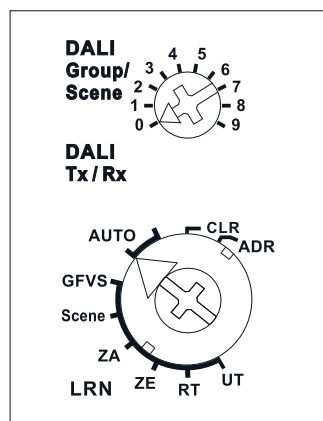

Standard setting ex works.

Further settings can be made using the PC Tool PCT14 (see page 1-5).



Manuals and documents in further languages:
<http://eltako.com/redirect/FDG14>

FDG14	RS485 bus DALI gateway for rail mounting	Art. No. 30014047	95,60 €/pc.
--------------	--	--------------------------	--------------------

WIRELESS DALI GATEWAY FOR FLUSH-MOUNTED BOX FDG62-230V AND DALI BUS POWER SUPPLY UNIT 80 MA FOR FLUSH-MOUNTED BOX DL-N2-80MA



Manuals and documents in further languages:
<http://eltako.com/redirect/FDG62-230V>

FDG62-230V



Wireless DALI gateway, bidirectional. Only 0.5 watt standby loss.

For installation. 49 x 51 mm, 20 mm deep.

The connection terminals are plug-in terminals for conductor cross-sections from 0.2 mm² to 2.5 mm².

The convenient tap technology permits the teach-in of up to 32 wireless universal pushbuttons, wireless direction pushbuttons, wireless central control pushbuttons, motion sensors, tunable white and intensity double rocker pushbuttons.

Bidirectional wireless switchable.

Power supply 230 V at terminals N and L.

The DALI bus power supply DL-N2-80mA and up to 40 DALI devices are connected to the DALI terminals.

The gateway FDG62 controls DALI devices with Enocean wireless transmitters.

Only **broadcast commands** can be sent.

In addition to the radio control input via an internal antenna, the connected DALI devices can also be controlled with a 230 V control button that may be installed in front of the FDG62.

A glow lamp current is not permitted.

The FDG62 internally saves the dimming value and supplies this value as feedback. The same feedback telegrams are generated as for an FD62NPN.

Actuators can then be activated by the feedback signals.

The FDG62 fulfils the function of the DALI master.

FDG62-230V	Wireless DALI Gateway for flush-mounted box	Art. No. 30100868	79,80 €/pc.
------------	---	-------------------	-------------

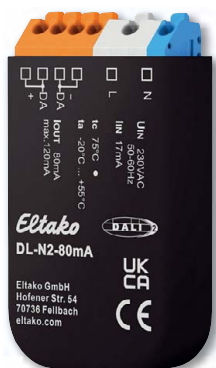

Manuals and documents in further languages:
<http://eltako.com/redirect/DL-N2-80mA>

DL-N2-80mA



DALI2 bus power supply unit with 80 mA output current for supplying up to 40 standard DALI devices. 59 x 33 x 15 mm. Suitable for flush-mounted box and installation in protection class II devices.

DALI2 certified. DALI2 is the newest generation of the DALI standard with an extended range of functions.

DALI2 devices also include all previous DALI functions and are therefore backwards compatible.

The connection terminals are plug-in terminals for conductor cross-sections from 0,5 mm² to 1,5 mm².

Input: supply voltage range 120 V..240 V AC/50-60 Hz.

Maximum input current 10 mA. Power-up ramp-up time 250 ms. Power loss max. 2 W.

Output: Output voltage range 12 V DC..20.5 V DC. Output current 80 mA.

No-load proof and short-circuit proof.

Degree of protection housing IP40. Degree of protection terminals IP20.

Impulse voltage category II. Pollution degree 2. Rated insulation voltage 250 V. Rated impulse voltage 4 kV.

Reinforced insulation. Insulation test voltage 3 kV.

Temperature at mounting location -20°C to +55°C.

Storage temperature -20°C to +75°C.

Relative humidity 15% to 90%.

DL-N2-80mA	DALI bus power supply unit 80 mA for flush-mounted box	Art. No. 33000026	92,60 €/pc.
------------	--	-------------------	-------------



FDG71L-230V



Wireless DALI gateway, bidirectional. 2 watt standby loss.

Installation for example in suspended ceilings and lamps.

Installation for example in suspended ceilings and lamps.
 252 mm long, 46 mm wide and 31 mm high. With cable fixation.
 Power supply 230 V at terminals N and L.

16 V DC/130 mA can be connected to the DALI terminals +/- for up to 64 DALI devices.

The gateway FDG71L controls DALI devices with EnOcean wireless transmitters.

Groups 0-15 can be controlled and the **broadcast command** can be sent. In addition **DALI scenes 0-15** can be controlled.

DALI installations, which are to be fully controlled with the FDG71L, must be configured in groups 0-15.

The FDG71L internally saves the dimming value for each of the groups 0-15 and supplies this value as feedback. The same feedback telegrams are generated as for an FUD71.

The feedbacks of the device addresses correspond to the dimming values of the DALI groups 0-15 in ascending order.

Feedbacks can be converted by the PCT14 for each individual group of dimming value telegrams (%) to pushbutton telegrams (ON/OFF). Feedbacks can then control actuators.

The FDG71L fulfils the functions of the DALI master and the DALI power supply.

Important: Wireless pushbuttons always need to be double-clicked when they are taught-in manually in the FDG71L. CLR only needs a single click.

A direction pushbutton or universal pushbutton with identical ID and identical pushbutton can be taught in several times in different groups. The group last selected is always valid. Therefore, a pushbutton can either switch only one group or broadcast to all groups.

One FBH per group can also be taught in. With a manual teach-in this always acts dependent on brightness. With PCT14 you can also set the brightness threshold.

The delay time for switch-off after no motion is detected can be set together in minutes (1 ... 60) for the FBH devices of all groups. The default is 3 minutes.

Function rotary switches

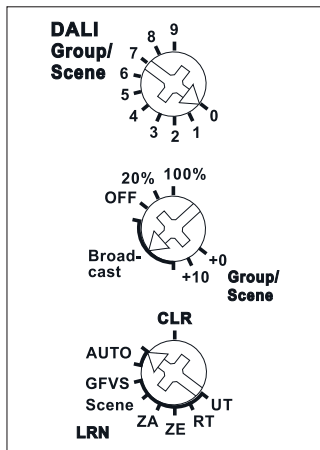

Standard setting ex works.

Further settings can be made and actuators configured using the PC Tool PCT14 and the data transformer DAT71.



Manuals and documents in further languages:
<http://eltako.com/redirect/FDG71L-230V>

FDG71L-230V	Wireless DALI gateway for ceiling installation	Art. No. 30100867	140,60 €/pc.
--------------------	--	--------------------------	---------------------



Manuals and documents in further languages:
http://eltako.com/redirect/DL-1CH-8A-DC12*

DALI-Cockpit page 7-25.
 DL-USB page 7-26.

DL-1CH-8A-DC12+



DALI LED 1 channel dimmer for luminaire installation and flush-mounted box. 59x33x15 mm.
Protection class IP20. Only 0.12 watt standby loss.

Designed to control **constant voltage** LED modules (CV) at operating voltages of 12 V to 48 V, Sw&Dim or SwitchDim2: Operation via 1 or 2 pushbutton inputs permits brightness control without DALI; alternatively, corridor function for direct activation with a motion detector.

Dimming range 0.1%-100%. Switchable PWM frequency (122 Hz/244 Hz/488 Hz/976 Hz).

Supply voltage 12 V to 48 V DC.

Max. connected current 8 A.

High efficiency. Configuration via DALI Cockpit PC software and DALI USB interface.

Operating modes:

The output channel is controlled by a DALI address (Device Type 6). Alternatively, operation can also take place by one (Sw&Dim) or two pushbutton inputs (SwitchDim2).

SwD1, Sw&Dim: brightness. Press pushbutton briefly: On/Off. Press pushbutton long: Dim.

SwD2: Scene switch (press pushbutton briefly).

If you press the SwD1 input for 2 minutes, the mode changes to 'Corridor function'. This operating mode remains enabled until the device is disconnected from the power supply (after PowerUp: operation via SwD1/SwD2).

Corridor function:

Mode with integrated staircase time switch (e.g. simple activation of one or several motion detectors by relay contact). When you press the input, the maximum value is switched on. After the input signal decays, the brightness remains at this value for the duration of the hold time before it drops down to the intermediate value. After the hold time for the intermediate value expires, brightness returns to the basic value. The process starts from the beginning when the input is re-activated.

The DALI Cockpit software can configure 1-channel LED dimmers. You can define both group assignment and configure scene values and DALI parameters (the parameters displayed are the as-delivered states).

As-delivered state:

Before the first address is assigned, you can control the device using the group address G0. This preset group assignment is deleted when addresses are assigned. Afterwards, you can define any group assignment in the DALI Cockpit. The values defined in the DALI standard are generated by sending a DALI reset command.

DL-1CH-8A-DC12+	DALI LED 1 channel dimmer 8 A for flush-mounted box	Art. No. 33000015	127,80 €/pc.
------------------------	---	--------------------------	---------------------



7-6



Manuals and documents in further languages:
<http://eltako.com/redirect/DL-1CH-16A-DC12+>

DALI-Cockpit page 7-25.
 DL-USB page 7-26.

DL-1CH-16A-DC12+



DALI2 LED 1 channel dimmer for ceiling installation. 120x30x22 mm. Protection class IP20. Only 0.12 watt standby loss.

DALI2 certified. DALI2 is the newest generation of the DALI standard with an extended range of functions. DALI2 devices also include all previous DALI functions and are therefore backwards compatible. Designed to control **constant voltage** LED modules (CV) at operating voltages of 12 V to 48 V, Sw&Dim or SwitchDim2: Operating via 1 or 2 pushbutton inputs permits brightness control without DALI; alternatively, corridor function for direct activation with a motion detector.

Dimming range 0.1%-100%. Selectable PWM frequency (122 Hz/244 Hz/488 Hz/976 Hz).

Supply voltage 12 V to 48 V DC.

Max. connected current 16 A.

High efficiency. Configuration via DALI Cockpit PC software and DALI USB interface.

Operating modes:

The output channel is controlled by a DALI address (Device Type 6). Alternatively, it can also be operated by one (Sw&Dim) or two pushbutton inputs (SwitchDim2).

SwD1, Sw&Dim: brightness. Press pushbutton briefly: On/Off. Press pushbutton long: Dim.

SwD2: Scene switch (press pushbutton briefly).

If you press the SwD1 input for 2 minutes, the mode changes to 'Corridor function'. This operating mode remains enabled until the device is disconnected from the power supply (after PowerUp: operation via SwD1/SwD2).

Corridor function:

Mode with integrated staircase time switch (e.g. simple activation of one or several motion detectors by relay contact). When you press the input, the maximum value is switched on. After the input signal decays, the brightness remains at this value for the duration of the hold time before it drops down to the intermediate value. After the hold time for the intermediate value expires, brightness returns to the basic value. The process starts from the beginning when the input is re-activated.

The DALI Cockpit software can configure 1-channel LED dimmers. You can define both group assignment and configure scene values and DALI parameters (the parameters displayed are the as-delivered states).

As-delivered state:

Before the first address is assigned, you can control the device using the group address G0. This preset group assignment is deleted when addresses are assigned. Afterwards, you can define any group assignment in the DALI Cockpit. The values defined in the DALI standard are generated by sending a DALI reset command.

DL-1CH-16A-DC12+	DALI2 LED 1 channel dimmer 16 A for ceiling installation	Art. No. 33000016	146,50 €/pc.
-------------------------	--	--------------------------	---------------------

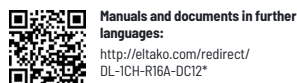

Manuals and documents in further languages:
http://eltako.com/redirect/DL-1CH-R16A-DC12*

DALI-Cockpit page 7-25.
DL-USB page 7-26.

DL-1CH-R16A-DC12+



DALI LED 1 channel dimmer for DIN-EN 60715 TH35 rail mounting. 98x17,5x56 mm. Protection class IP20. Only 0.12 watt standby loss.

Designed to control **constant voltage** LED modules (CV) at operating voltages of 12 V to 48 V, Sw&Dim or SwitchDim2: Operation via 1 or 2 pushbutton inputs permits brightness control without DALI; alternatively, corridor function for direct activation with a motion detector.

Dimming range 0.1%-100%. Switchable PWM frequency (122 Hz/244 Hz/488 Hz/976 Hz).

Supply voltage 12 V to 48 V DC.

Max. connected current 16 A.

High efficiency. Configuration via DALI Cockpit PC software and DALI USB interface.

Operating modes:

The output channel is controlled by a DALI address (Device Type 6). Alternatively, it can also be operated by one (Sw&Dim) or two pushbutton inputs (SwitchDim2).

SwD1, Sw&Dim: brightness. Press pushbutton briefly: On/Off. Press pushbutton long: Dim.

SwD2: Scene switch (press pushbutton briefly).

If you press the SwD1 input for 2 minutes, the mode changes to 'Corridor function'. This operating mode remains enabled until the device is disconnected from the power supply (after PowerUp: operation via SwD1/SwD2).

Corridor function:

Mode with integrated staircase time switch (e.g. simple activation of one or several motion detectors by relay contact). When you press the input, the maximum value is switched on. After the input signal decays, the brightness remains at this value for the duration of the hold time before it drops down to the intermediate value. After the hold time for the intermediate value expires, brightness returns to the basic value. The process starts from the beginning when the input is re-activated.

The DALI Cockpit software can configure 1-channel LED dimmers. You can define both group assignment and configure scene values and DALI parameters (the parameters displayed are the as-delivered states).

As-delivered state:

Before the first address is assigned, you can control the device using the group address G0. This preset group assignment is deleted when addresses are assigned. Afterwards, you can define any group assignment in the DALI Cockpit. The values defined in the DALI standard are generated by sending a DALI reset command.

7-7

DL-1CH-R16A-DC12+	DALI LED 1 channel dimmer 16 A for DIN-EN 60715 TH35 rail mounting	Art. No. 33000022	147,90 €/pc.
--------------------------	--	--------------------------	---------------------

DALI LED DIMMER 8 A TUNABLE WHITE FOR FLUSH-MOUNTED BOX DL-TW-2LT-8A-DC12+



Manuals and documents in further languages:
http://eltako.com/redirect/DL-TW-2LT-8A-DC12*

7-8

DALI-Cockpit page 7-25.
 DL-USB page 7-26.

DL-TW-2LT-8A-DC12+



DALI LED dimmer for separate control of brightness and colour temperature. For luminary installation and flush-mounted box. 59x33x15 mm. Protection class IP20. Only 0.12 watt standby loss.

Designed to control **constant voltage** LED modules (CV) at operating voltages of 12 V to 48 V, operating mode DT8: control brightness and colour temperature by a DALI address (Device Type 8, Colour Type Tc) operating mode Balance&Dim: activated via 2 DALI addresses, one to adjust brightness and one to set channel distribution (e.g. colour temperature).

Operating mode Dim2Warm: one DALI address to dim and to change the colour temperature at the same time. SwitchDim2: operation via 2 pushbutton inputs permits control of brightness and colour temperature without DALI.

Dimming range 0.1%-100%.

Switchable PWM frequency (122 Hz/244 Hz/488 Hz/976 Hz).

Power supply depending on type from 12 V to 28 V DC or 12 V to 48 V DC (depending on operating voltage of LED modules).

Connected current 8 A. The maximum connected current can be distributed to any channel.

High efficiency. Configuration via DALI Cockpit PC software and DALI USB interface.

Operating modes:

The device has several operating modes:

DT8 (as-delivered state): in this mode a DALI address (Device Type 8, Colour Type Tc) is used to control brightness and colour temperature. Alternatively, operation can also take place by one or two pushbutton inputs (SwitchDim2).

SwD1: brightness. Press pushbutton briefly: On/Off. Press pushbutton long: Dim.

SwD2: Colour temperature.

Balance&Dim: Control is by means of 2 DALI addresses (or SwitchDim2); one address is used for dimming and the other for channel distribution (i.e., e.g.: tunable white or direct/indirect lighting distribution).

The Balance&Dim mode is used to adjust colour temperature without affecting brightness and vice versa. Adjustment is by means of DALI standard commands such as Dim Up/Down. This permits all customary controls and gateways (e.g. KNX). This control option is an alternative to DT8-Tc mode.

Operable via DALI or SwitchDim2:

DALI address 1, SwD1: brightness.

DALI address 2, SwD2: Balance.

Dim2Warm: The two output channels are controlled by a DALI address or an SwD input. Channel distribution is permanently coupled to the dimming value. The smaller the dimming value, the warmer the light.

DALI address 1, SwD1: Dim2Warm (Master). Press pushbutton briefly: On/Off. Press pushbutton long: Dim.

DL-TW-2LT-8A-DC12+	DALI LED dimmer 8 A tunable white for flush-mounted box	Art. No. 33000010	143,50 €/pc.
---------------------------	---	--------------------------	---------------------

DALI2 LED DIMMER 16 A TUNABLE WHITE FOR CEILING INSTALLATION
DL-TW-2LT-16A-DC12+

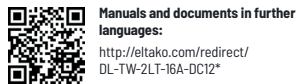

Manuals and documents in further languages:
http://eltako.com/redirect/DL-TW-2LT-16A-DC12*

DALI-Cockpit page 7-25.
 DL-USB page 7-26.

DL-TW-2LT-16A-DC12+



DALI2 LED dimmer for separate control of brightness and colour temperature. For ceiling installation. 120x30x22 mm. Protection class IP20. Only 0.12 watt standby loss.

DALI2 certified. DALI2 is the newest generation of the DALI standard with an extended range of functions. DALI2 devices also include all previous DALI functions and are therefore backwards compatible. Designed to control **constant voltage** LED modules (CV) at operating voltages of 12 V to 48 V, operating mode DT8: control brightness and colour temperature by a DALI address (Device Type 8, Colour Type Tc) operating mode Balance&Dim: activated via 2 DALI addresses, one to adjust brightness and one to set channel distribution (e.g. colour temperature). Operating mode Dim2Warm: one DALI address to dim and to change the colour temperature at the same time. SwitchDim2: operation via 2 pushbutton inputs permits control of brightness and colour temperature without DALI.

Dimming range 0.1%-100%.
 Switchable PWM frequency (122 Hz/244 Hz/488 Hz/976 Hz).
 Power supply depending on type from 12 V to 28 V DC or 12 V to 48 V DC (depending on operating voltage of LED modules).
 Connected current 16 A. The maximum connected current can be distributed to any channel.
 High efficiency. Configuration via DALI Cockpit PC software and DALI USB interface.

Operating modes:

The device has several operating modes:
DT8 (as-delivered state): in this mode a DALI address (Device Type 8, Colour Type Tc) is used to control brightness and colour temperature. Alternatively, operation can also take place by one or two pushbutton inputs (SwitchDim2).
 SwD1: brightness. Press pushbutton briefly: On/Off. Press pushbutton long: Dim.
 SwD2: Colour temperature.
Balance&Dim: Control is by means of 2 DALI addresses (or SwitchDim2); one address is used for dimming and the other for channel distribution (i.e., e.g.: tunable white or direct/indirect lighting distribution). The Balance&Dim mode is used to adjust colour temperature without affecting brightness and vice versa. Adjustment is by means of DAKL standard commands such as Dim Up/Down. This permits all customary controls and gateways (e.g. KNX). This control option is an alternative to DT8-Tc mode.
 Operable via DALI or SwitchDim2:
 DALI address 1, SwD1: brightness.
 DALI address 2, SwD2: Balance.
Dim2Warm: The two output channels are controlled by a DALI address or an SwD input. Channel distribution is permanently coupled to the dimming value. The smaller the dimming value, the warmer the light.
 DALI address 1, SwD1: Dim2Warm (Master). Press pushbutton briefly: On/Off. Press pushbutton long: Dim.

DL-TW-2LT-16A-DC12+	DALI2 LED dimmer 16 A tunable white for ceiling installation	Art. No. 33000011	172,50 €/pc.
----------------------------	--	--------------------------	---------------------

DALI LED DIMMER 16 A TUNABLE WHITE FOR DIN-EN 60715 TH35 RAIL MOUNTING DL-TW-2LT-R16A-DC12+



7-10



Manuals and documents in further languages:
http://eltako.com/redirect/DL-TW-2LT-R16A-DC12*

DALI-Cockpit page 7-25.
DL-USB page 7-26.

DL-TW-2LT-R16A-DC12+



DALI LED dimmer for separate control of brightness and colour temperature. For DIN-EN 60715 TH35 rail mounting. 98x17,5x56 mm. Protection class IP20. Only 0.12 watt standby loss.

Device with 2 DALI tunable white LED dimmers.

Designed to control **constant voltage** LED modules for 12 V to 48 V.

2 DALI addresses (Device Type 8, Colour Type Tc).

Each DT8-Tc address permits the separate control of brightness and colour temperature.

Dimming range 1%-100%.

PWM frequency 488 Hz.

Power voltage from 12 V to 48 V DC.

Connected current from 16 A. The maximum connected current can be distributed as required.

High efficiency >98%.

Configuration via DALI Cockpit PC software and DALI USB interface.

Settings:

The device includes 2 DALI tunable white LED dimmers. A DALI address is used to control each dimmer. The addresses support DT8 commands (Colour Type Tc) to control brightness and colour temperature separately from each other.

DL-TW-2LT-R16A-DC12+	DALI LED dimmer 16 A tunable white for DIN-EN 60715 TH35 rail mounting	Art. No. 33000012	186,20 €/pc.
-----------------------------	--	--------------------------	---------------------



Manuals and documents in further languages:
<http://eltako.com/redirect/DL-RGB-8A-DC12+>

DALI-Cockpit page 7-25.
 DL-USB page 7-26.

DL-RGB-8A-DC12+



DALI LED dimmer with RGB colour control for luminaire installation and flush-mounted box. 59x33x15 mm. Protection class IP20. Only 0.12 watt standby loss.

Designed to control **constant voltage** LED modules (CV) at operating voltages of 12 V to 48 V, operating mode DT8: a DALI address to control brightness and colour DALI DT8, Type RGBWAF).

Operating mode Colour&Dim: activated by 2 DALI addresses, one to adjust brightness and one to set the colour.

SwitchDim2: Operation via 2 switch inputs permit brightness and colour to be controlled without DALI. Dimming range 0.1%-100%.

Switchable PWM frequency (122 Hz/244 Hz/488 Hz/976 Hz).

Power voltage 12 V to 48 V DC (depending on operating voltage of LED modules).

Connected current 8 A. The maximum connected current can be distributed to the channels as required.

Low stand-by losses.

High efficiency.

Configuration via DALI Cockpit PC software and DALI USB interface.

Operating modes:

The device has several operating modes:

DT8 (as-delivered state): In this operating mode brightness and colour are controlled by a DALI address (Device Type 8). Alternatively, operation can also take place by two pushbutton inputs (SwitchDim2):

SwD1: brightness. Press pushbutton briefly: On/Off. Press pushbutton long: Dim.

SwD2: Colour.

Colour&Dim: This operating mode is used to control RGB luminaries. Control is by means of 2 DALI addresses; one address affects brightness and the other affects channel distribution (e.g.: colour).

Colour&Dim mode is used to adjust colour temperature without affecting brightness and vice versa.

Adjustment is by means of DALI standard commands such as Dim Up/Down. This permits all customary controls and gateways (e.g. KNX). This control option is an alternative to DT8-RGBWAF mode.

Operable via DALI or SwitchDim2:

DALI address 1, SwD1: brightness.

DALI address 2, SwD2: Colour.

DL-RGB-8A-DC12+	DALI LED RGB dimmer 8 A for flush-mounted box (DT8)	Art. No. 33000013	159,00 €/pc.
------------------------	---	--------------------------	---------------------

DALI2 LED RGB DIMMER 16 A FOR CEILING INSTALLATION (DT8) DL-RGB-16A-DC12+



7-12



Manuals and documents in further languages:
http://eltako.com/redirect/DL-RGB-16A-DC12*

DALI-Cockpit page 7-25.
 DL-USB page 7-26.

DL-RGB-16A-DC12+



DALI2 LED dimmer with RGB colour control for ceiling installation. 120x30x22 mm. Protection class IP20. Only 0.12 watt standby loss.

DALI2 certified. DALI2 is the newest generation of the DALI standard with an extended range of functions. DALI2 devices also include all previous DALI functions and are therefore backwards compatible.

Designed to control **constant voltage** LED modules (CV) at operating voltages of 12 V to 48 V, operating mode DT8: a DALI address to control brightness and colour DALI DT8, Type RGBWAF).

Operating mode Colour&Dim: activated by 2 DALI addresses, one to adjust brightness and one to set the colour.

SwitchDim2: Operation via 2 switch inputs permit brightness and colour to be controlled without DALI. Dimming range 0.1%-100%.

Switchable PWM frequency (122 Hz/244 Hz/488 Hz/976 Hz).

Power voltage 12 V to 48 V DC (depending on operating voltage of LED modules).

Connected current 16 A. The maximum connected current can be distributed to the channels as required.

Low stand-by losses.

High efficiency.

Configuration via DALI Cockpit PC software and DALI USB interface.

Operating modes:

The device has several operating modes:

DT8 (as-delivered state): In this operating mode brightness and colour are controlled by a DALI address (Device Type 8). Alternatively, operation can also take place by two pushbutton inputs (SwitchDim2):

SwD1: brightness. Press pushbutton briefly: On/Off. Press pushbutton long: Dim.

SwD2: Colour.

Colour&Dim: This operating mode is used to control RGB luminaires. Control is by means of 2 DALI addresses; one address affects brightness and the other affects channel distribution (e.g.: colour).

Colour&Dim mode is used to adjust colour temperature without affecting brightness and vice versa.

Adjustment is by means of DALI standard commands such as Dim Up/Down. This permits all customary controls and gateways (e.g. KNX). This control option is an alternative to DT8-RGBWAF mode.

Operable via DALI or SwitchDim2:

DALI address 1, SwD1: brightness.

DALI address 2, SwD2: Colour.

DL-RGB-16A-DC12+	DALI2 LED RGB dimmer 16 A for ceiling installation (DT8)	Art. No. 33000014	199,50 €/pc.
-------------------------	--	--------------------------	---------------------

DALI LED RGB DIMMER 16 A FOR DIN-EN 60715 TH35 RAIL MOUNTING (DT8) DL-RGB-R16A-DC12+

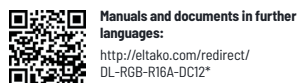

DALI-Cockpit page 7-25.
DL-USB page 7-26.

DL-RGB-R16A-DC12+



**DALI LED dimmer with RGB colour control for DIN-EN 60715 TH35 rail mounting. 98x17,5x56 mm.
Protection class IP20. Only 0.12 watt standby loss.**

Designed to control **constant voltage** LED modules (CV) at operating voltages of 12 V to 48 V, operating mode DT8: a DALI address to control brightness and colour DALI DT8, Type RGBWAF).
Operating mode Colour&Dim: activated by 2 DALI addresses, one to adjust brightness and one to set the colour.

SwitchDim2: Operation via 2 switch inputs permit brightness and colour to be controlled without DALI.
Dimming range 0.1%-100%.

Switchable PWM frequency (122 Hz/244 Hz/488 Hz/976 Hz).

Power voltage 12 V to 48 V DC (depending on operating voltage of LED modules).

Connected current 16 A. The maximum connected current can be distributed to the channels as required.

Low stand-by losses.

High efficiency.

Configuration via DALI Cockpit PC software and DALI USB interface.

Operating modes:

The device has several operating modes:

DT8 (as-delivered state): In this operating mode brightness and colour are controlled by a DALI address (Device Type 8). Alternatively, operation can also take place by two pushbutton inputs (SwitchDim2):

SwD1: brightness. Press pushbutton briefly: On/Off. Press pushbutton long: Dim.

SwD2: Colour.

Colour&Dim: This operating mode is used to control RGB luminaries. Control is by means of 2 DALI addresses; one address affects brightness and the other affects channel distribution (e.g.: colour).

Colour&Dim mode is used to adjust colour temperature without affecting brightness and vice versa.

Adjustment is by means of DALI standard commands such as Dim Up/Down. This permits all customary controls and gateways (e.g. KNX). This control option is an alternative to DT8-RGBWAF mode.

Operable via DALI or SwitchDim2:

DALI address 1, SwD1: brightness.

DALI address 2, SwD2: Colour.

DL-RGB-R16A-DC12+	DALI LED RGB dimmer 16 A for DIN-EN 60715 TH35 rail mounting (DT8)	Art. No. 33000023	199,50 €/pc.
--------------------------	--	--------------------------	---------------------



Manuals and documents in further languages:
<http://eltako.com/redirect/DL-3CH-8A-DC12+>

DL-3CH-8A-DC12+



3 channels DALI LED dimmer for luminary installation and flush-mounted box. 59x33x15 mm. Protection class IP20. Only 0.12 watt standby loss.

Designed to control **constant voltage** LED modules (CV) at operating voltages of 12 V to 48 V, operating mode DT6: separate control of channels via 3 DALI addresses.

Operating mode Colour&Dim: activated by 2 DALI addresses, one to adjust brightness and one to set the colour.

SwitchDim2: operation via 2 pushbutton inputs permits control of brightness and colour without DALI. Dimming range 0.1%-100%.

Switchable PWM frequency (122 Hz/244 Hz/488 Hz/976 Hz).

Power supply from 12 V to 48 V DC (depending on operating voltage of LED modules).

Connected current 8 A. The maximum connected current can be distributed to any channel.

High efficiency.

Configuration via DALI Cockpit PC software and DALI USB interface.

Operating modes:

The device has several operating modes:

DT6 (as-delivered state): In this operating mode each channel is controlled by a separate DALI address (Device Type 6). Alternatively, operation can also take place by two pushbutton inputs (SwitchDim2):

SwD1: brightness. Press pushbutton briefly: On/Off. Press pushbutton long: Dim.

SwD2: Scene switch (press pushbutton briefly).

Colour&Dim: This operating mode is used to control RGB luminaires. Control is by means of 2 DALI addresses; one address affects brightness and the other affects channel distribution (e.g.: colour).

Colour&Dim mode is used to adjust colour temperature without affecting brightness and vice versa.

Adjustment is by means of DALI standard commands such as Dim Up/Down. This permits all customary controls and gateways (e.g. KNX). This control option is an alternative to DT8-RGBWAF mode.

Operable via DALI or SwitchDim2: DALI address 1, SwD1: brightness. DALI address 2, SwD2: Colour.

DL-3CH-8A-DC12+	DALI LED 3 channels dimmer 8 A for flush-mounted box (DT6)	Art. No. 33000017	143,40 €/pc.
------------------------	--	--------------------------	---------------------



Manuals and documents in further languages:
http://eltako.com/redirect/DL-3CH-16A-DC12*

DALI-Cockpit page 7-25.
 DL-USB page 7-26.

DL-3CH-16A-DC12+



DALI2 LED 3 channels dimmer for ceiling installation 120x30x22 mm. Protection class IP20. Only 0.12 watt standby loss.

DALI2 certified. DALI2 is the newest generation of the DALI standard with an extended range of functions. DALI2 devices also include all previous DALI functions and are therefore backwards compatible. Designed to activate **constant voltage** LED modules (CV) at operating voltages of 12 V to 48 V, operating mode DT6: separate control of channels via 3 DALI addresses.

Operating mode Colour&Dim: activated by 2 DALI addresses, one to adjust brightness and one to set the colour.

SwitchDim2: operation via 2 pushbutton inputs permits control of brightness and colour without DALI. Dimming range 0.1%-100%.

Switchable PWM frequency (122 Hz/244 Hz/488 Hz/976 Hz).

Power supply from 12 V to 48 V DC (depending on operating voltage of LED modules).

Connected current 16 A. The maximum connected current can be distributed to any channel.

High efficiency.

Configuration via DALI Cockpit PC software and DALI USB interface.

Operating modes:

The device has several operating modes:

DT6 (as-delivered state): In this operating mode each channel is controlled by a separate DALI address (Device Type 6). Alternatively, operation can also take place by two pushbutton inputs (SwitchDim2):

SwD1: brightness. Press pushbutton briefly: On/Off. Press pushbutton long: Dim.

SwD2: Scene switch (press pushbutton briefly).

Colour&Dim: This operating mode is used to control RGB luminaires. Control is by means of 2 DALI addresses; one address affects brightness and the other affects channel distribution (e.g.: colour).

Colour&Dim mode is used to adjust colour temperature without affecting brightness and vice versa.

Adjustment is by means of DALI standard commands such as Dim Up/Down. This permits all customary controls and gateways (e.g. KNX). This control option is an alternative to DT8-RGBWAF mode.

Operable via DALI or SwitchDim2: DALI address 1, SwD1: brightness. DALI address 2, SwD2: Colour.

DL-3CH-16A-DC12+	DALI2 LED 3 channels dimmer 16 A for ceiling installation (DT6)	Art. No. 33000018	161,40 €/pc.
-------------------------	---	--------------------------	---------------------

DALI LED 3 CHANNELS DIMMER 16 A FOR DIN-EN 60715 TH35 RAIL MOUNTING (DT6) DL-3CH-R16A-DC12+



7-16



Manuals and documents in further languages:
http://eltako.com/redirect/DL-3CH-R16A-DC12*

DALI-Cockpit page 7-25.
DL-USB page 7-26.

DL-3CH-R16A-DC12+



3 channels DALI LED dimmer for DIN-EN 60715 TH35 rail mounting. 98x17,5x56 mm. Protection class IP20. Only 0.12 watt standby loss.

Designed to control **constant voltage** LED modules (CV) at operating voltages of 12 V to 48 V, operating mode DT6: separate control of channels via 3 DALI addresses.

Operating mode Colour&Dim: activated by 2 DALI addresses, one to adjust brightness and one to set the colour.

SwitchDim2: operation via 2 pushbutton inputs permits control of brightness and colour without DALI. Dimming range 0.1%-100%.

Switchable PWM frequency (122 Hz/244 Hz/488 Hz/976 Hz).

Power supply from 12 V to 48 V DC (depending on operating voltage of LED modules).

Connected current 16 A. The maximum connected current can be distributed to any channel.

High efficiency.

Configuration via DALI Cockpit PC software and DALI USB interface.

Operating modes:

The device has several operating modes:

DT6 (as-delivered state): In this operating mode each channel is controlled by a separate DALI address (Device Type 6). Alternatively, operation can also take place by two pushbutton inputs (SwitchDim2):

SwD1: brightness. Press pushbutton briefly: On/Off. Press pushbutton long: Dim.

SwD2: Scene switch (press pushbutton briefly).

Colour&Dim: This operating mode is used to control RGB luminaries. Control is by means of 2 DALI addresses; one address affects brightness and the other affects channel distribution (e.g.: colour).

Colour&Dim mode is used to adjust colour temperature without affecting brightness and vice versa.

Adjustment is by means of DALI standard commands such as Dim Up/Down. This permits all customary controls and gateways (e.g. KNX). This control option is an alternative to DT8-RGBWAF mode.

Operable via DALI or SwitchDim2: DALI address 1, SwD1: brightness. DALI address 2, SwD2: Colour.

DL-3CH-R16A-DC12+	DALI LED 3 channels dimmer 16 A for DIN-EN 60715 TH35 rail mounting (DT6)	Art. No. 33000024	161,40 €/pc.
--------------------------	---	--------------------------	---------------------

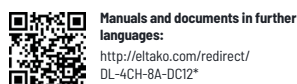

Manuals and documents in further languages:
<http://eltako.com/redirect/DL-4CH-8A-DC12+>

DALI-Cockpit page 7-25.
 DL-USB page 7-26.

DL-4CH-8A-DC12+



4 channels DALI LED dimmer for luminary installation and flush-mounted box. 59x33x15 mm. Protection class IP20. Only 0.12 watt standby loss.

Designed to control **constant voltage** LED modules (CV) at operating voltages of 12 V to 48 V, operating mode DT6: separate control of channels via 4 DALI addresses.
 Operating mode Colour&Dim: activated by 2 DALI addresses, one to adjust brightness and one to set the colour.
 SwitchDim2: operation via 2 pushbutton inputs permits control of brightness and colour without DALI. Dimming range 0.1%-100%.
 Switchable PWM frequency (122 Hz/244 Hz/488 Hz/976 Hz).
 Power supply from 12 V to 48 V DC (depending on operating voltage of LED modules).
 Connected current 8 A. The maximum connected current can be distributed to any channel.
 High efficiency.
 Configuration via DALI Cockpit PC software and DALI USB interface.

Operating modes:

The device has several operating modes:

DT6 (as-delivered state): In this operating mode each channel is controlled by a separate DALI address (Device Type 6). Alternatively, operation can also take place by two pushbutton inputs (SwitchDim2):

SwD1: brightness. Press pushbutton briefly: On/Off. Press pushbutton long: Dim.

SwD2: Scene switch (press pushbutton briefly).

Colour&Dim: This operating mode is used to control RGB luminaries. Control is by means of 2 DALI addresses; one address affects brightness and the other affects channel distribution (e.g.: colour).

Colour&Dim mode is used to adjust colour temperature without affecting brightness and vice versa.

Adjustment is by means of DALI standard commands such as Dim Up/Down. This permits all customary controls and gateways (e.g. KNX). This control option is an alternative to DT8-RGBWAF mode.

Operable via DALI or SwitchDim2: DALI address 1, SwD1: brightness. DALI address 2, SwD2: Colour.

DL-4CH-8A-DC12+	DALI LED 4 channels dimmer 8 A for flush-mounted box (DT6)	Art. No. 33000019	157,00 €/pc.
------------------------	--	--------------------------	---------------------

DALI2 LED 4 CHANNELS DIMMER 16 A FOR CEILING INSTALLATION (DT6) DL-4CH-16A-DC12+



7-18



Manuals and documents in further languages:
http://eltako.com/redirect/DL-4CH-16A-DC12*

DALI-Cockpit page 7-25.
 DL-USB page 7-26.

DL-4CH-16A-DC12+



DALI2 LED 4 channels dimmer for ceiling installation 120x30x22 mm. Protection class IP20. Only 0.12 watt standby loss.

DALI2 certified. DALI2 is the newest generation of the DALI standard with an extended range of functions. DALI2 devices also include all previous DALI functions and are therefore backwards compatible. Designed to control **constant voltage** LED modules (CV) at operating voltages of 12 V to 48 V, operating mode DT6: separate control of channels via 4 DALI addresses.

Operating mode Colour&Dim: activated by 2 DALI addresses, one to adjust brightness and one to set the colour.

SwitchDim2: operation via 2 pushbutton inputs permits control of brightness and colour without DALI. Dimming range 0.1%-100%.

Switchable PWM frequency (122 Hz/244 Hz/488 Hz/976 Hz).

Power supply from 12 V to 48 V DC (depending on operating voltage of LED modules).

Connected current 16 A. The maximum connected current can be distributed to any channel.

High efficiency.

Configuration via DALI Cockpit PC software and DALI USB interface.

Operating modes:

The device has several operating modes:

DT6 (as-delivered state): In this operating mode each channel is controlled by a separate DALI address (Device Type 6). Alternatively, operation can also take place by two pushbutton inputs (SwitchDim2):

SwD1: brightness. Press pushbutton briefly: On/Off. Press pushbutton long: Dim.

SwD2: Scene switch (press pushbutton briefly)

Colour&Dim: This operating mode is used to control RGB luminaires. Control is by means of 2 DALI addresses; one address affects brightness and the other affects channel distribution (e.g.: colour).

Colour&Dim mode is used to adjust colour temperature without affecting brightness and vice versa.

Adjustment is by means of DALI standard commands such as Dim Up/Down. This permits all customary controls and gateways (e.g. KNX). This control option is an alternative to DT8-RGBWAF mode.

Operable via DALI or SwitchDim2: DALI address 1, SwD1: brightness. DALI address 2, SwD2: Colour.

DL-4CH-16A-DC12+	DALI2 LED 4 channels dimmer 16 A for ceiling installation (DT6)	Art. No. 33000020	174,90 €/pc.
-------------------------	---	--------------------------	---------------------

DALI LED 4 CHANNELS DIMMER 16 A FOR DIN-EN 60715 TH35 RAIL MOUNTING (DT6) DL-4CH-R16A-DC12+

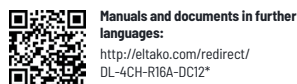

Manuals and documents in further languages:
http://eltako.com/redirect/DL-4CH-R16A-DC12*

DALI-Cockpit page 7-25.
DL-USB page 7-26.

DL-4CH-R16A-DC12+



**DALI LED 4 channels dimmer for DIN-EN 60715 TH35 rail mounting. 98x17,5x56 mm.
Protection class IP20. Only 0.12 watt standby loss.**

Designed to control **constant voltage** LED modules (CV) at operating voltages of 12 V to 48 V, operating mode DT6: separate control of channels via 4 DALI addresses.

Operating mode Colour&Dim: activated by 2 DALI addresses, one to adjust brightness and one to set the colour.

SwitchDim2: operation via 2 pushbutton inputs permits control of brightness and colour without DALI. Dimming range 0.1%-100%.

Switchable PWM frequency (122 Hz/244 Hz/488 Hz/976 Hz).

Power supply from 12 V to 48 V DC (depending on operating voltage of LED modules).

Connected current 16 A. The maximum connected current can be distributed to any channel.

High efficiency.

Configuration via DALI Cockpit PC software and DALI USB interface.

Operating modes:

The device has several operating modes:

DT6 (as-delivered state): In this operating mode each channel is controlled by a separate DALI address (Device Type 6). Alternatively, operation can also take place by two pushbutton inputs (SwitchDim2):

SwD1: brightness. Press pushbutton briefly: On/Off. Press pushbutton long: Dim.

SwD2: Scene switch (press pushbutton briefly).

Colour&Dim: This operating mode is used to control RGB luminaries. Control is by means of 2 DALI addresses; one address affects brightness and the other affects channel distribution (e.g.: colour).

Colour&Dim mode is used to adjust colour temperature without affecting brightness and vice versa.

Adjustment is by means of DALI standard commands such as Dim Up/Down. This permits all customary controls and gateways (e.g. KNX). This control option is an alternative to DT8-RGBWAF mode.

Operable via DALI or SwitchDim2: DALI address 1, SwD1: brightness. DALI address 2, SwD2: Colour.

DL-4CH-R16A-DC12+	DALI LED 4 channels dimmer 16 A for DIN-EN 60715 TH35 rail mounting (DT6)	Art. No. 33000021	190,60 €/pc.
--------------------------	---	--------------------------	---------------------

DALI2 RELAY MODULE 8 A FOR FLUSH-MOUNTED BOX (DT7) DL-RM8A



Manuals and documents in further languages:
<http://eltako.com/redirect/DL-RM8A>

7-20

DALI-Cockpit page 7-25.
 DL-USB page 7-26.

DL-RM8A



Module to control a relay contact over the DALI2 bus (DT7) for luminary installation and flush-mounted box. 59x33x15 mm. Protection class IP20. DALI current consumption 2.7 mA.

DALI2 certified. DALI2 is the newest generation of the DALI standard with an extended range of functions. DALI2 devices also include all previous DALI functions and are therefore backwards compatible. Compact relay module for direct control of 230 V loads over DALI. Loads without DALI input are easily integrated in a DALI circuit. Loads can be switched on/off by DALI commands. The device function complies with the standard for DALI Device Type 7 – switching function (as of Firmware 2.0). Adjustable characteristic for power-up and bus power failure. The DALI RM8 is powered over the DALI bus. No additional power supply is required. Zero passage switch-on. The module represents a bus user and is therefore addressable. Configuration via DALI Cockpit PC software.

DALI functions and command set:

The DALI RM8 can integrate loads on the DALI bus and can then switch them on/off. The DALI RM8 is a control device for non-dimmable loads based on the DALI specifications in IEC 62386-208 (Device Type 7). Accordingly, the switch characteristic is determined by comparing the virtual dim level (VDAP) with 4 switching thresholds. The virtual dim level (VDAP) corresponds to the dim level of a DALI electronic ballast with its corresponding characteristics (limited by MINLEVEL and MAXLEVEL, dimming speed limited by fade time and fade rate). There are 2 switching thresholds in each dimming direction and they are used for comparison with the virtual dim level. Only the applicable switching threshold for the current virtual dimming direction is evaluated. A threshold with the value 'MASK' is inactive and is not used in the comparison. Switch-on/off delays can be implemented with fading. The DALI RM8 is powered from the DALI bus. The relay response to a bus power failure can be configured by the SystemFailureLevel (no change, ON or OFF, factory setting: ON). The power-on response after applying bus power can be set with PowerOnLevel.

DL-RM8A	DALI2 relay module 8 A for flush-mounted box (DT7)	Art. No. 33000007	150,20 €/pc.
----------------	--	--------------------------	---------------------



Manuals and documents in further languages:
<http://eltako.com/redirect/DL-RM16A-HS-WE>

DALI-Cockpit page 7-25.
 DL-USB page 7-26.

DL-RM16A-HS-WE



Module to control a relay contact over the DALI bus (DT7) for DIN top-hat rails DIN-EN 60715 TH35. 98x17,5x56 mm. Protection class IP20. DALI current consumption 2.7 mA.

Compact relay module for direct control of 230V loads over DALI. Loads without DALI input are easily integrated in a DALI circuit. Loads can be switched on/off by DALI commands. The device function complies with the standard for DALI Device Type 7 – switching function (as of Firmware 2.0). Adjustable characteristic for power-up and bus power failure.

The DALI RM16 is powered over the DALI bus. No additional power supply is required.

Zero passage switch-on. Integrated power-on current limit, particularly suitable for loads with very high power-on current (>100 A). The interface represents a bus user and is therefore addressable.

Configuration via DALI Cockpit PC software.

DALI functions and command set:

The DALI RM16 can integrate loads on the DALI bus and can then switch them on/off.

The DALI RM16 is a control device for non-dimmable loads based on the DALI specifications in IEC 62386-208 (Device Type 7). Accordingly, the switch characteristic is determined by comparing the virtual dim level (VDAP) with 4 switching thresholds.

The virtual dim level (VDAP) corresponds to the dim level of a DALI electronic ballast with its corresponding characteristics (limited by MINLEVEL and MAXLEVEL, dimming speed limited by fade time and fade rate).

There are 2 switching thresholds in each dimming direction and they are used for comparison with the virtual dim level. Only the applicable switching threshold for the current virtual dimming direction is evaluated.

A threshold with the value 'MASK' is inactive and is not used in the comparison.

Switch-on/off delays can be implemented with fading.

The DALI RM16 is powered from the DALI bus. The relay response to a bus power failure can be configured by the SystemFailureLevel (no change, ON or OFF, factory setting: ON). The power-on response after applying bus power can be set with PowerOnLevel.

DL-RM16A-HS-WE	DALI relay module 16 A for DIN-EN 60715 TH35 rail mounting (DT7)	Art. No. 33000006	174,90 €/pc.
-----------------------	--	--------------------------	---------------------

DL-PD-300W-RLC



Phase dimmer with DALI control input for ceiling installation. 120x30x22 mm. Protection class IP20.

Suitable for dimming 230 V LED retrofit luminaries using DALI. Converts DALI dimming level to a voltage with leading or trailing edge. The minimum dimming level (MIN LEVEL) is adjustable via DALI. Additional operating mode as switch (conforms to DT7) as from Firmware 3.5. The module represents a bus user and is therefore addressable. Double terminals for easy looping of the DALI bus.

Dimming range 0.1%-100%.

Supply voltage 230 V AC.

Output load range 10-300 W.

High efficiency. Configuration via DALI Cockpit PC software.

Function:

The DALI PD is an interface between classic dimming technology (phase dimming) and DALI which is based on the standard for DALI Control Gear (IEC 62386-102) and Device Type 4 equipment (IEC 62386-205). The DALI PD interface converts the required dimming level into a corresponding voltage signal with leading or trailing edge. Depending on the load the universal dimmer operates as a leading or trailing edge dimmer. The operating mode can be requested over DALI (DT4). The dimming characteristic is based on a logarithmic scale as stipulated in the DALI standard. The leading or trailing edge control supplies a sinusoidal voltage with a phase-cut on the leading or trailing edge. The PHYSICAL MINLEVEL is 3%.

As of Firmware version 3.5 the DALI PD is equipped with an additional operating mode. It is switchable from DT4 operating mode (phase dimming) to DT7 (switch). In this operating mode the DALI PD acts as a switch. Its behaviour in this mode corresponds to the DALI standard for DT7 devices (IEC62386-208).

In this operating mode the switch characteristic is determined by comparing the virtual dim level (VDAP) with 4 switching thresholds.

The virtual dim level (VDAP) corresponds to the dim level of a DALI electronic ballast with its corresponding characteristics (limited by MINLEVEL and MAXLEVEL, dimming speed limited by fade time and fade rate). There are 2 switching thresholds in each dimming direction and they are used for comparison with the virtual dim level:

A threshold with the value 'MASK' is inactive and is not used in the comparison.

Switch-on/off delays can be implemented with fading.

The device is powered from the DALI bus so that there is only partial support for the SYSTEM FAILURE LEVEL. On current devices (identified by Firmware > 4.0), you can choose between 0%,100% and MASK. On older models the SYSTEM FAILURE LEVEL is fixed - the 25 W variant outputs 100%; the 300 W variant outputs 0%.



Manuals and documents in further languages:
<http://eltako.com/redirect/DL-PD-300W-RLC>

DALI-Cockpit page 7-25.
 DL-USB page 7-26.

DL-PD-300W-RLC	DALI Phase dimmer 300 W for ceiling installation (DT4)	Art. No. 33000009	228,80 €/pc.
-----------------------	--	--------------------------	---------------------

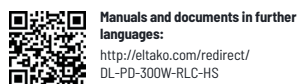

DALI-Cockpit page 7-25.
DL-USB page 7-26.

DL-PD-300W-RLC-HS



**Phase dimmer with DALI control input for DIN top-hat rails DIN-EN 60715 TH35. 98x17,5x56 mm.
Protection class IP20.**

Suitable for dimming 230 V LED retrofit luminaires using DALI Converts DALI dimming level to a voltage with leading or trailing edge. The minimum dimming level (MIN LEVEL) is adjustable via DALI. Additional operating mode as switch (conforms to DT7) as from Firmware 3.5. The module represents a bus user and is therefore addressable. Double terminals for easy looping of the DALI bus.

Dimming range 0.1%-100%.

Supply voltage 230 V AC.

Output load range 10-300 W.

High efficiency. Configuration via DALI Cockpit PC software.

Function:

The DALI PD is an interface between classic dimming technology (phase dimming) and DALI which is based on the standard for DALI Control Gear (IEC 62386-102) and Device Type 4 equipment (IEC 62386-205). The DALI PD interface converts the required dimming level into a corresponding voltage signal with leading or trailing edge. Depending on the load the universal dimmer operates as a leading or trailing edge dimmer. The operating mode can be requested over DALI (DT4). The dimming characteristic is based on a logarithmic scale as stipulated in the DALI standard. The leading or trailing edge control supplies a sinusoidal voltage with a phase-cut on the leading or trailing edge. The PHYSICAL MINLEVEL is 3%.

As of Firmware version 3.5 the DALI PD is equipped with an additional operating mode. It is switchable from DT4 operating mode (phase dimming) to DT7 (switch). In this operating mode the DALI PD acts as a switch. Its behaviour in this mode corresponds to the DALI standard for DT7 devices (IEC62386-208).

In this operating mode the switch characteristic is determined by comparing the virtual dim level (VDAP) with 4 switching thresholds.

The virtual dim level (VDAP) corresponds to the dim level of a DALI electronic ballast with its corresponding characteristics (limited by MINLEVEL and MAXLEVEL, dimming speed limited by fade time and fade rate). There are 2 switching thresholds in each dimming direction and they are used for comparison with the virtual dim level:

A threshold with the value 'MASK' is inactive and is not used in the comparison.

Switch-on/off delays can be implemented with fading.

The device is powered from the DALI bus so that there is only partial support for the SYSTEM FAILURE LEVEL. On current devices (identified by Firmware > 4.0), you can choose between 0%,100% and MASK. On older models the SYSTEM FAILURE LEVEL is fixed - the 25 W variant outputs 100%; the 300 W variant outputs 0%.

DL-PD-300W-RLC-HS	DALI Phase dimmer 300 W for DIN-EN 60715 TH35 rail mounting (DT4)	Art. No. 33000008	228,80 €/pc.
--------------------------	---	--------------------------	---------------------

DALI CONTROL UNIT FOR CONTROLLING THE CIRCADIAN COURSE OF DAYLIGHT FOR FLUSH-MOUNTED BOX DL-CTV



Manuals and documents in further languages:
<http://eltako.com/redirect/DL-CTV>

7-24

DALI-Cockpit page 7-25.
DL-USB page 7-26.

DL-CTV



DALI control unit for controlling the circadian course of daylight of DT8-Tc capable luminaries. For luminary installation and flush-mounted box. 59x33x15 mm. Only 0.12 watt standby loss.

Device to control DALI-DT8 luminaries (Tc mode) with a daylight pattern adapted to biorhythm. DALI real time clock. Settable automatic summer/winter changeover.

Configurable: scene behaviour and brightness curve.

Set clock and simply adapt the required daylight pattern via DALI Cockpit software tool.

The DALI CDC module is powered directly over the DALI bus.

Internal battery for clock (as-delivered state set to local time (GMT+1)).

Function:

The DALI CDC sends the required colour temperature to the controlled area. A single address, a group address or a broadcast can be defined as the controlled area.

The basis for the colour temperature curve is defined by 24 reference points (one for every full hour).

The colour temperature curve is interpolated between the reference points.

The behaviour can be configured for every GOTO SCENE X command. The DALI CDC can switch to active or inactive or ignore the command. Scene behaviour is configurable for the device address, the controlled area and for broadcast control.

A brightness value can be defined for every reference point (as-delivered state: MASK -> no influence on brightness).

DL-CTV	DALI control unit for controlling the circadian course of daylight for flush-mounted box	Art. No. 33000001	311,60 €/pc.
---------------	--	--------------------------	---------------------

DALI COCKPIT AND DALI-MONITOR

Software to commission DALI systems and monitor DALI bus communication.

The following functions are supported:

Addressing DALI systems, configuration of DALI components, configuration of standard DALI operating units, definition of groups and scenes, logging bus communication, sending DALI commands and saving/loading the entire system configuration.

The software requires a DALI USB interface module DL-USB mini or SL-Flash- USB.

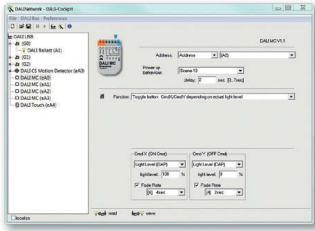

Download:
http://eltako.com/redirect/DALI-Cockpit_und_DALI-Monitor

DALI-Cockpit and DALI-Monitor	DALI commissioning tool	Download: Scan QR code or go to website: Downloads. Software
--------------------------------------	-------------------------	--

OVERVIEW SOFTWARE

Dali USB interface

Installation

addressing

Scenes configuration

Sends the DALI command OFF to all devices

Sends the DALI command RECALL MAX to all devices

The diagram shows a central software window with a hardware image of the DALI USB 30mA Lunatone interface on the left. The software interface includes an 'Info' section with fields for Name (DALI USB PS 30mA), Manufacturer (Lunatone), Ver (2.2.1), and Serial Number (114550). Below this is a 'DALI: Addressing and Commands' section with buttons for 'Addressing...', 'DALI Commands...', and 'Configure Scenes...'. A 'Bus power' section has a green indicator and 'ON', 'On', and 'Off' buttons. The 'Config Control Gear' section features sliders for 'Actual Level', 'MIN Level', 'MAX Level', 'Power On Level', 'System Fail Level', 'Fade Time', and 'Fade Rate', each with a 'Set' button. At the bottom are buttons for 'Off', 'Min', 'Max', 'Up', 'Down', 'Step Up', 'Step Down', 'On and Step Up', 'Step Down and Off', and a 'Recall' button.

**DALI-USB INTERFACE FOR FLUSH-MOUNTED BOX DL-USB MINI AND
DALI-USB INTERFACE FOR DIN-EN 60715 TH35 RAIL MOUNTING DL-FLASH-USB**



More informations in further languages:
<http://eltako.com/redirect/DL-USB-mini>

DL-USB MINI



**Interface for communication between PC programs and modules in the DALI lighting system.
For luminary installation and flush-mounted box. 59x33x15 mm. Protection class IP20.**

Interface module for communication between a DALI system and PC applications.

Bidirectional data traffic.

For addressing, configuration, status queries, parameter settings of DALI components.

Support for DALI standard and various extended DALI protocols. Monitoring DALI bus communication.

Galvanic isolation. Powered over the DALI bus and the USB interface.

DALI Cockpit PC software to configure and monitor a DALI system.

Double DALI terminals to loop the DALI bus connection.

DL-USB mini	DALI-USB interface for flush-mounted box	Art. No. 33000002	408,10 €/pc.
--------------------	--	--------------------------	---------------------

7-26



Manuals and documents in further languages:
<http://eltako.com/redirect/DL-Flash-USB>

DL-FLASH-USB



**Interface for communication between PC programs and modules in the DALI lighting system.
For DIN-EN 60715 TH35 rail mounting. 98x17,5x56 mm. Protection class IP20.**

Interface module for communication between a DALI system and PC applications.

Bidirectional data traffic.

For addressing, configuration, status queries, parameter settings of DALI components. Support for DALI

standard and various extended DALI protocols. Monitoring DALI bus communication.

Galvanic isolation. Powered over the DALI bus and the USB interface.

DALI Cockpit PC software to configure and monitor a DALI system.

Double DALI terminals to loop the DALI bus connection.

DL-Flash-USB	DALI-USB interface for DIN-EN 60715 TH35 rail mounting	Art. No. 33000025	414,40 €/pc.
---------------------	--	--------------------------	---------------------

Type	DL-RM8A, DL-1CH-8A-DC12+, DL-TW-2LT-8A-DC12+, DL-RGB-8A-DC12+, DL-3CH-8A-DC12+, DL-4CH-8A-DC12+	DL-1CH-16A-DC12+, DL-TW-2LT-16A-DC12+, DL-RGB-16A-DC12+, DL-3CH-16A-DC12+, DL-4CH-16A-DC12+	DL-RM16A-HS-WE DL-1CH-R16A-DC12+, DL-TW-2LT-R16A-DC12+, DL-RGB-R16A-DC12+, DL-3CH-R16A-DC12+, DL-4CH-R16A-DC12+	DL-USB-mini, DL-Flash-USB	DL-PD-300W-RLC DL-PD-300W-RLC-HS
Power supply	12 V DC-48 V DC DL-RM8A: via DALI bus	12 V DC-48 V DC	12 V DC-48 V DC DL-RM16A: via DALI bus	via USB	230 V
Connected current	8 A	16 A	16 A	-	300 W
DALI current consumption	2 mA	2 mA	2 mA	-	2 mA
State after network recovery	adjustable via DALI: 0%-100%, final value	adjustable via DALI: 0%-100%, final value	adjustable via DALI: 0%-100%, final value	-	adjustable via DALI: 0%-100%, final value
Expected service life (at Tc<=75°C)	>100000 h	>100000 h	>100000 h	-	∞
Protection class	IP20	IP20	IP20	IP20	IP20
Max. wire cross section	1.5 mm ²	2.5 mm ² , DALI/Sw&Dim: 1.5 mm ² DL-TW-2LT-: 1.5 mm ² , power supply (V+, V-): 2.5 mm ²	2.5 mm ² , DALI/Sw&Dim: 1.5 mm ² DL-TW-2LT-: 1.5 mm ² , power supply (V+, V-): 2.5 mm ²	-	DL-PD-300W-RLC: 1.5 mm ² DL-PD-300W-RLC-HS: 2.5 mm ²
Housing/installation	Luminary installation and flush-mounted box	Ceiling installation	DIN rail DIN-EN 60715 TH35	DL-USB-mini: Flush-mounted box DL-Flash-USB: DIN rail IN-EN 60715 TH35	DL-PD-300W-RLC: Ceiling installation DL-PD-300W-RLC-HS: DIN rail DIN-EN 60715 TH35

**ESR62NP-IP
EUD62NPN-IP
ESB62NP-IP**

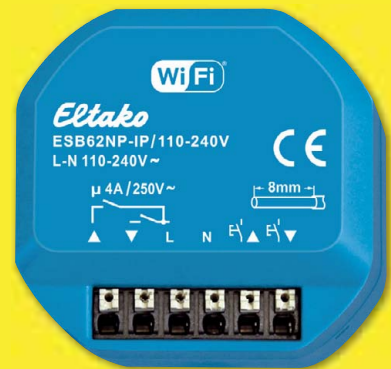

**8 IP ACTUATORS FOR DECENTRALISED INSTALLATION.
APPLE HOME CERTIFIED, REST-API
AND "BUILT FOR MATTER".**



built for



**Our new IP actuators for the classic,
wired installation.
Apple Home certified, REST-API
and "built for Matter".**



built for



NEW	<u>Impulse switch with integrated relay function via Wi-Fi 1 NO contact, not potential free 16 A ESR62NP-IP/110-240V</u>	8-2
NEW	<u>Impulse switch with integrated relay function via Wi-Fi 1 NO contact, potential free 16 A ESR62PF-IP/110-240V</u>	8-3
NEW	<u>Universal dimming actuator IP via Wi-Fi, up to 300 W EUD62NPN-IP/110-240V/50Hz</u>	8-4
NEW	<u>Shading actuator IP via Wi-Fi, 1+1 NO contact, not potential 4 A, automatic end position detection ESB62NP-IP/110-240V</u>	8-5

IMPULSE SWITCH WITH INTEGRATED RELAY FUNCTION VIA WI-FI 1 NO CONTACT, NOT POTENTIAL FREE 16 A, APPLE HOME CERTIFIED, REST-API AND "BUILT FOR MATTER" ESR62NP-IP/110-240V



Typical connection

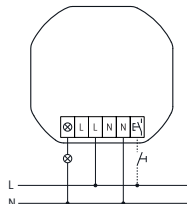

built for



Eltako Connect app



Download Eltako Connect app:
<http://eltako.com/redirect/eltako-connect>



More informations and further languages:
http://eltako.com/redirect/ESR62NP-IP*110-240V

ESR62NP-IP/110-240V



Impulse switch with integrated relay function via WiFi with 1 NO contact, not potential free, 16 A/250 V AC, 230 V LED lamps up to 600 W, 230 V incandescent lamps and halogen lamps 2000 W. Apple Home certified, REST-API and "built for Matter". Only 0.7 watt standby loss.

For installation. 49 x 51 mm, 25 mm deep.

The terminals are plug-in terminals for conductor cross-sections of 0.2 mm² to 2.5 mm².

Zero passage switching to protect contacts and lamps.

Supply, switching and control voltage locally 110-240 V.

In case of a power failure the system is disconnected in a preset sequence.

State-of-the-art hybrid technology combines advantages of nonwearing electronic control with high capacity of special relays.

With control input for a mains voltage control button that may be installed in front of it.

Glow lamp current is not permitted.

The Wi-Fi link uses the 2.4 GHz frequency band and permits **Over-the-Air updates (OTA)**. **This actuator is Apple Home certified and can be officially controlled directly via the Apple Home app and Siri. No additional controller or gateway are required:**

The **Apple Home app** offers the following functions:

- Create and execute scenes
- Create if-then automations including geofencing
- Manual switching
- Call up status

An Apple controller, e.g. HomePod mini, is required for remote access.

As an option, the actuator can be configured via the Eltako Connect app.

A development version of the REST API is available through the device's online product page. This is continuously being further developed.

The actuator meets all the specifications for the Matter standard, is "built for Matter" and is in the Matter certification process.

ESR62NP-IP/110-240V	Impulse switch with integrated relay function via Wi-Fi 1 NO contact, not potential free 16 A Apple Home certified, REST-API and "built for Matter"	Art. No. 30062001	61,10 €/pc.
----------------------------	---	--------------------------	--------------------

IMPULSE SWITCH WITH INTEGRATED RELAY FUNCTION VIA WI-FI 1 NO CONTACT, POTENTIAL FREE 16A, APPLE HOME CERTIFIED, REST-API AND "BUILT FOR MATTER" ESR62PF-IP/110-240V



Typical connection

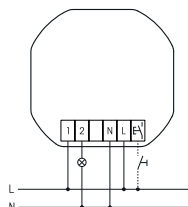

built for



Eltako Connect app

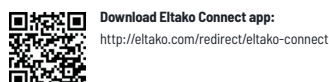

Download Eltako Connect app:
<http://eltako.com/redirect/eltako-connect>

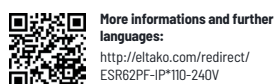

More informations and further languages:
http://eltako.com/redirect/ESR62PF-IP*110-240V

ESR62PF-IP/110-240V



Impulse switch with integrated relay function IP via Wi-Fi with 1 NO contact, potential free, 16 A/250 V AC, 230 V LED lamps up to 200 W, 230 V incandescent lamps and halogen lamps 2000 W. Apple Home certified, REST-API and "built for Matter". Only 0.7 watt standby loss.

For installation. 49 x 51 mm, 25 mm deep.

The terminals are plug-in terminals for conductor cross-sections of 0.2 mm² to 2.5 mm².

Supply and control voltage locally 110-240 V.

Distance control connections/contact 6 mm.

In case of a power failure the system is disconnected in a preset sequence.

State-of-the-art hybrid technology combines advantages of nonwearing electronic control with high capacity of special relays.

With control input for a mains voltage control button that may be installed in front of it.

Glow lamp current is not permitted.

The Wi-Fi link uses the 2.4 GHz frequency band and permits **Over-the-Air updates (OTA)**. **This actuator is Apple Home certified and can be officially controlled directly via the Apple Home app and Siri. No additional controller or gateway are required:**

The **Apple Home app** offers the following functions:

- Create if-then automations including geofencing
- Manual switching
- Call up status

An Apple controller, e.g. HomePod mini, is required for remote access.

As an option, the actuator can be configured via the Eltako Connect app.

A development version of the REST API is available through the device's online product page. This is continuously being further developed.

The actuator meets all the specifications for the Matter standard, is "built for Matter" and is in the Matter certification process.

ESR62PF-IP/110-240V	Impulse switch with integrated relay function via Wi-Fi 1 NO contact, potential free 16 A Apple Home certified, REST-API and "built for Matter"	Art. No. 30062004	58,20 €/pc.
----------------------------	---	--------------------------	--------------------

**UNIVERSAL DIMMING ACTUATOR IP VIA WI-FI, UP TO 300 W
APPLE HOME CERTIFIED, REST-API AND "BUILT FOR MATTER" EUD62NPN-IP/110-240V**



Typical connection

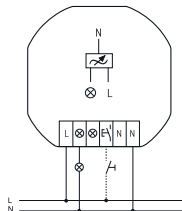

built for



Eltako Connect app



Download Eltako Connect app:
<http://eltako.com/redirect/eltako-connect>



More informations and further languages:
http://eltako.com/redirect/EUD62NPN-IP*110-240V

EUD62NPN-IP/110-240V



Universal dimming actuator IP via Wi-Fi. Apple Home certified, REST-API and "built for Matter". With power MOSFET. Dimmable 230 V LED lamps in 'phase cut-off' mode up to 300 W or in 'phase control' mode up to 100 W depending on ventilation conditions. 230 V incandescent lamps and halogen lamps up to 300 W depending on ventilation conditions. No minimum load. Only 0.7 watt standby loss.

For installation. 49 x 51 mm wide, 25 mm deep.

The terminals are plug-in terminals for conductor cross-sections of 0.2 mm² to 2.5 mm².

Zero passage switching with soft ON and soft OFF to protect lamps.

Supply voltage, switching voltage and control voltage local 110-240 V.

The brightness level is stored on switch-off (memory).

If supply voltage fails, the device is switched off in defined mode.

Automatic electronic overload protection and overtemperature switch-off.

With control input for a mains voltage control button that may be installed in front of it.

Glow lamp current is not permitted.

The Wi-Fi link uses the 2.4 GHz frequency band and permits **Over-the-Air updates (OTA)**. **This actuator is Apple Home certified and can be officially controlled directly via the Apple Home app and Siri. No additional controller or gateway are required:**

The **Apple Home app** offers the following functions:

- Create if-then automations including geofencing
- Manual switching
- Call up status

An Apple controller, e.g. HomePod mini, is required for remote access.

As an option, the actuator can be configured via the Eltako Connect app.

A development version of the REST API is available through the device's online product page. This is continuously being further developed.

The actuator meets all the specifications for the Matter standard, is "built for Matter" and is in the Matter certification process.

EUD62NPN-IP/110-240V	Universal dimming actuator IP via Wi-Fi, up to 300 W Apple Home certified, REST-API and "built for Matter"	Art. No. 30062002	82,10 €/pc.
-----------------------------	---	--------------------------	--------------------

**SHADING ACTUATOR IP VIA WI-FI, 1+1 NO CONTACT 4A, AUTOMATIC END POSITION DETECTION
APPLE HOME CERTIFIED, REST-API AND "BUILT FOR MATTER" ESB62NP-IP/110-240V**



Typical connection

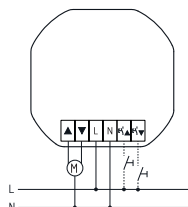

built for



Eltako Connect app

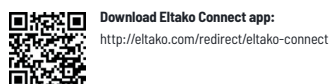

Download Eltako Connect app:
<http://eltako.com/redirect/eltako-connect>

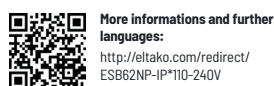

More informations and further languages:
http://eltako.com/redirect/ESB62NP-IP*110-240V

ESB62NP-IP/110-240V



Shading actuator IP via Wi-Fi, 1+1 NO contact 4 A/250 V AC, not potential free, for a shading element motor 230 V AC. automatic end position detection. Apple Home certified, REST-API and "built for Matter". Only 0.8 watt standby loss.

For installation. 49 x 51 mm, 25 mm deep.

The terminals are plug-in terminals for conductor cross-sections of 0.2 mm² to 2.5 mm².

Zero passage switching to protect contacts.

Supply, switching and control voltage locally 110-240 V.

In case of a power failure the system is disconnected in a preset sequence.

State-of-the-art hybrid technology combines advantages of nonwearing electronic control with high capacity of special relays.

With control input for a mains voltage control button that may be installed in front of it.

Glow lamp current is not permitted.

The Wi-Fi link uses the 2.4 GHz frequency band and permits **Over-the-Air updates (OTA)**. **This actuator is Apple Home certified and can be officially controlled directly via the Apple Home app and Siri. No additional controller or gateway are required:**

The **Apple Home app** offers the following functions:

- Create if-then automations including geofencing
- Manual switching
- Call up status

An Apple controller, e.g. HomePod mini, is required for remote access.

As an option, the actuator can be configured via the Eltako Connect app.

A development version of the REST API is available through the device's online product page. This is continuously being further developed.

The actuator meets all the specifications for the Matter standard, is "built for Matter" and is in the Matter certification process.

ESB62NP-IP/110-240V	Shading actuator IP via Wi-Fi, 1+1 NO contact 4 A, automatic end position detection Apple Home certified, REST-API and "built for Matter"	Art. No. 30062003	70,70 €/pc.
----------------------------	--	--------------------------	--------------------

**EUD12NPN
EUD12D
EUD61NP**



9

THE RIGHT LIGHT FOR EVERY MOOD.

Universal dimmer switches, capacity enhancer and 1-10 V controllers

Selection table for universal dimmer switches, capacity enhancer and 1-10 V controllers	9 - 2
Universal dimmer switch EUD12NPN-UC	9 - 3
Digital settable multifunction universal dimmer switch EUD12D-UC	9 - 4
Universal dimmer switch EUD12F for mains disconnection switching	9 - 5
Universal dimmer switch with rotary knob EUD12DK/800W-UC	9 - 6
Capacity enhancer for universal dimmer switches LUD12-230V	9 - 7
Digitally adjustable motor dimmer MOD12D-UC	9 - 9
Fully electronic multifunction time relay MFZ12PMD-UC with 18 functions	9 - 10
1-10 V control dimmer switch SDS12/1-10V for electronic ballast units	9 - 11
1-10 V controller SUD12/1-10V for universal dimmer switches	9 - 12
Universal dimmer switch EUD61NP-230V without N connection	9 - 13
Universal dimmer switch EUD61NPL-230V without N connection, especially for LED	9 - 14
Universal dimmer switch EUD61NPN-UC	9 - 15
Universal dimmer switch EUD61NPN-230V	9 - 16
Multifunction universal dimmer switch EUD61M-UC	9 - 17
LED dimmer switch ELD61/12-36V DC	9 - 18
1-10 V control dimmer switch SDS61/1-10V for electronic ballast units	9 - 19
Technical data universal dimmer switches, capacity enhancers and 1-10 V controllers	9 - 20

SELECTION TABLE FOR UNIVERSAL DIMMER SWITCHES, CAPACITY ENHANCER AND 1-10 V CONTROLLERS

THE ENERGY SAVERS



Set the mood and reduce energy costs at the same time - a fascinating combination for LED lamps, incandescent lamps and halogen lamps. The dimming of lamps in combination with soft ON and soft OFF, prolongs their lifetime considerably. This applies also to the infinitely dimmable energy saving lamps. Only universal dimmers with the marking R, L, C recognize automatically the connected load and

adjust their dimming function accordingly. Other dimmers have to be exchanged if lamps with other kind of loads are used later.

Only universal dimmer switches with the added LED marking and added ESL marking have the associated comfort settings.

Page		9-3	9-4	9-5	9-6	9-7	9-9	9-10	9-11	9-12	9-13	9-14	9-15	9-16	9-17	9-18	9-19
	pictograms	EUD12NPN-UC	EUD12D-UC	EUD12F	EUD12DK/800W-UC	LUD12-230V	MOD12D-UC	MFZ12PMD-UC	SDS12/1-10V	SUD12/1-10V	EUD6INP-230V	EUD6INPL-230V	EUD6INPN-UC	EUD6INPN-230V	EUD6IM-UC	ELD61/12-36V DC	SDS61/1-10V
	Modular device for DIN EN 60715 TH35 rail mounting, number of modules 18 mm each	1	1	1	2	1	1	1	1	1							
	Built-in device for installation (e.g. flush-mounting box) and surface mounting																
	Dimming R, L and C loads		■	■	■	■ ⁵⁾	L	■	1-10V EVG	1-10V EVG	■	R, C	■	■	■		1-10V EVG
	With comfort position for dimmable LEDs		■	■	■	■						■	■	■		■	
	With comfort position for dimmable energy saving lamps ESL		■	■	■	■						■	■	■	■		
	Power MOSFET up to W (nearly unlimited number of switching cycles)	400	400	300	800	400	300	400	—	400 ⁷⁾	400	200	400	400	400	4A	—
	Increase of capacity with capacity enhancer LUD12-230V		■		■			■		■ ⁷⁾							
	Zero passage switching		■	■	■	■	■	■	■	■	■	■	■	■	■	■	■
	Minimum brightness level adjustable		■	■	■	■	■ ⁶⁾	■	■	■ ⁷⁾	■	■	■	■	■	■	■
	Dimming speed adjustable		■	■	■	■	■ ⁶⁾	■	■	■ ⁷⁾	■	■	■ ⁸⁾	■ ⁸⁾		■ ⁸⁾	■
	Universal control voltage 8 to 230V UC		■	■	■	■ ⁶⁾	■	■	■	■ ⁶⁾			■		■	■	
	Supply voltage 230V		■	■	■	■	■	■	■	■	■ ¹⁾	■ ¹⁾	■	■	■		■
	Low standby loss		■	■	■	■	■	■	■	■	■	■	■	■	■	■	■
	Glow lamp current (mA) ²⁾⁴⁾		5	5 ³⁾		5 ⁶⁾		5									
	Central control electrically isolated from the local input			■		■ ⁶⁾	■	■	(■)	■ ⁶⁾							
	Switching operation for children's rooms		■	■	■	■ ⁶⁾			■	■ ⁶⁾	■	■	■	■	■	■	■
	Snooze function		■	■	■	■ ⁶⁾			■	■ ⁶⁾	■	■	■	■	■	■	■
	Multifunction		■					■		■ ⁶⁾					■		

* EVG = electronic ballast units ¹⁾ No N connection required. ²⁾ Applies to glow lamps with 170 V ignition voltage, for glow lamps with 90 V ignition voltage approx. 1/2 glow lamp current. ³⁾ Depends on the set function. ⁴⁾ Will automatically be switched on from 110 V control voltage. ⁵⁾ Same load as main dimmer switch or separate R, L or C load, depending on circuit. ⁶⁾ This specification refers to EUD12D, which is connected in series. ⁷⁾ This specification refers to the connected EUD12D or LUD12 depending on the selected mode. ⁸⁾ Minimum brightness level or dimming speed adjustable. ⁹⁾ Rotation speed determines the dimming speed.



EUD12NPN-UC



Universal dimmer switch. Power MOSFET up to 400 W. Automatic lamp detection. Standby loss 0.2 watt only. With adjustable minimum or maximum brightness and dimming speed. With switching operation for children's rooms and snooze function.

Modular device for DIN EN 60715 TH35 rail mounting. 1 module = 18 mm wide, 58 mm deep.

Universal dimmer switch for lamps up to 400 W, depending on ventilation conditions, dimmable 230 V LED lamps and dimmable energy saving lamps (ESL) are also dependent on the lamp electronics and the and the dimming technology, **see technical data page 9-20.**

Switching with soft start and soft OFF to protect lamps.

Universal control voltage input 12 to 230 V UC, electrically isolated from the 230 V supply voltage and switching voltage 230 V ~ 50/60Hz. No minimum load required.

Short-time control commands switch on/off, permanent control varies the brightness to the maximum level. An interruption of control changes the direction of dimming.

The setting of the brightness level is stored after switching off.

In case of a power failure the switching position and the brightness level are stored.

If applicable the dimmer will be switched on at the stored brightness level after the supply voltage is recovered. Glow lamp current up to 5 mA starting at 110 V.

Automatic electronic overload protection and over-temperature switch-off.

The LED below the top rotary switch on the front shows control commands. It starts blinking after 15 seconds if a pushbutton is inhibited.

During operation, **the upper rotary switch** determines whether the automatic lamp recognition 'AUTO' should be active, or one of the special comfort positions LC1, LC2 or LC3.

If the **MEM+** setting range is selected, the **memory function** is active and the last brightness level set is saved when the device is switched off. If the setting range **MEM-** is selected, the memory function is switched off and it is always switched on with maximum brightness. Dimmable energy-saving lamps must be operated on AUTO and MEM.

AUTO allows the dimming of all light species.

LC1 is a comfort position for dimmable 230 V LED lamps which are not being dimmed down enough when set to AUTO (trailing phase angle) dependent on the construction and must therefore be forced to leading phase angle.

LC2 and **LC3** are comfort positions for dimmable 230 V LED lamps like LC1, but with different dimming curves. **In positions LC1, LC2 and LC3 no inductive (wound) transformers should be used.** In addition, the maximum number of dimmable LED lamps can be lower than in the AUTO position dependent on the construction.

The minimum brightness level (completely dimmed down) or the maximum brightness level (completely dimmed up) is adjustable with the **middle % rotary switch.**

The dimming speed can be adjusted **with the lower dimming speed rotary switch.**

The duration of soft start and soft OFF is changed simultaneously.

With special switching operation for children's rooms: If the light is switched on by holding down the pushbutton, it starts at the lowest brightness level after approx. 1 second and dims up slowly as long as the pushbutton is held down without modifying the last stored brightness level.

Snooze function: With a double impulse the lighting is dimmed down from the current dimming position to the minimum brightness level and switched off. The current dimming position as well as the adjustable minimum brightness level determine the dimming time (max. = 60 minutes) which can be reduced as required. It can be switched off at any time by short-time control commands during the lighting is dimmed down. Holding down the pushbutton during the dimming down process dims up and stops the snooze function.

Mixing of L loads (inductive loads, e.g. wound transformers) and C loads (capacitive loads, e.g. electronic transformers) is not permitted. R loads (ohmic loads, e.g. 230 V incandescent lamps and halogen lamps) may be added anytime.

Mixing of L loads and C loads is possible with the dimmer switch **EUD12D** (page 9-4) in connection with capacity enhancer **LUD12** (page 9-7).

Function rotary switches

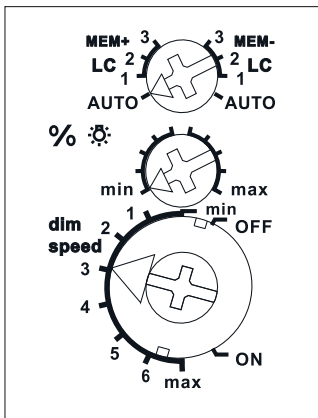

Standard setting ex works.

Typical connection

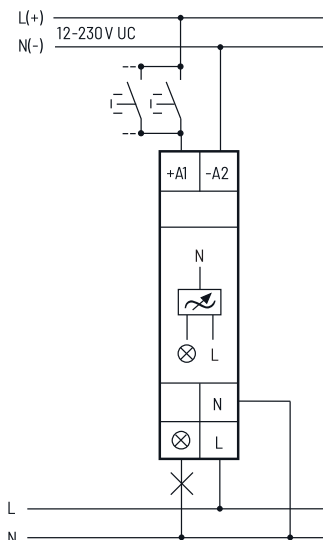

Manuals and documents in further languages:
<http://eltako.com/redirect/EUD12NPN-UC>

Technical data page 9-20.
 Housing for operating instructions
 GBA14 page 1-49 chapter 1.

EUD12NPN-UC	Universal dimmer switch, Power MOSFET up to 400 W	Art. No. 21100806	70,30 €/pc.
--------------------	--	--------------------------	--------------------

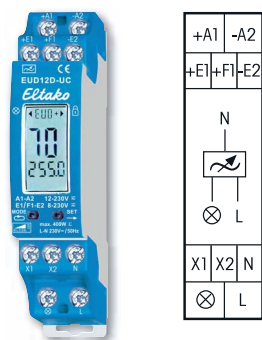

EUD12D-UC



Universal dimmer switch. Power MOSFET up to 400 W. Automatic lamp detection. Standby loss 0.3 watt only. With adjustable minimum brightness, maximum brightness and dimming speed. With switching operation for children's rooms and snooze function.

Modular device for DIN EN 60715 TH35 rail mounting. 1 module = 18 mm wide, 58 mm deep. Universal dimmer switch for lamps up to 400 W, depending on ventilation conditions, dimmable 230 V LED lamps and dimmable energy saving lamps (ESL) are also dependent on the lamp electronics and the dimming technology, **see technical data page 9-20.**

Up to 3600 W with capacity enhancers LUD12-230V (description page 9-7) at the terminals X1 and X2. Universal control voltage 12 to 230 V UC and additionally the universal voltage control inputs 8 to 230 V UC central ON and central OFF. The control inputs are electrically isolated from the supply voltage and switching voltage. **Zero passage switching with soft start and soft OFF to protect lamps.** In case of a power failure the switching position and the brightness level are stored. If applicable the dimmer will be switched on at the stored brightness level after the supply voltage is recovered. From 110 V control voltage glow lamp current up to 5 mA (not for DSD). Automatic electronic overload protection and over-temperature switch-off. The functions and times are entered using the MODE and SET keys as described in the operating manual and indicated on the LC display. A keylock function is provided.

You can dim all lamp types in automatic mode settings EUD, DSD, Udo, STS, MIN, MMX, CG and R. **EUD** = Universal dimmer switch with settings for dimming speed, minimum brightness, maximum brightness, memory and Soft ON/OFF as well as choice of priority for central control. ESL and LED is settable. Short-time control commands switch on/off, permanent control varies the brightness to the maximum level. A interruption of control changes the direction of dimming.

LED is a convenience setting for dimmable 230 V LED lamps which cannot be dimmed down far enough in automatic mode (phase cut-off) for design reasons and must therefore be forced to phase control. There is a choice of 3 dimming curves.

ESL is a convenience setting for energy saving lamps which must be switched on at high voltage for design reasons so that they can also be switched back on cold in dimmed state. Memory must be switched off on energy saving lamps which cannot be switched back on in dimmed state for design reasons.

No inductive (wound) transformers may be used in ESL and LED settings. In addition the maximum number of lamps may be lower than in automatic mode for design reasons.

Switching operation for children's rooms: If the light is switched on by holding down the pushbutton, it starts at the lowest brightness level after approx. 1 second and dims up slowly as long as the pushbutton is held down without modifying the last stored brightness level.

Snooze function: With a double impulse the lighting is dimmed down from the current dimming position to the minimum brightness level and switched off. The current dimming position as well as the adjustable minimum brightness level determine the dimming time (max. = 60 minutes) which can be reduced as required. It can be switched off at any time by short-time control commands during the lighting is dimmed down. Holding down the pushbutton during the dimming down process dims up and stops the snooze function.

DSD = Same as universal dimmer switch EUD but also comprising activation via two direction switches on the universal voltage control inputs 12..230 V UC.

Udo = Same as universal dimmer switch EUD but also comprising setting for a time delay from 1 to 99 minutes. Switch-off early warning at the end by dimming is selectable and adjustable from 1 to 3 minutes.

STS = Staircase time switch with switchable switch-off early warning by dimming. With pump and permanent light by pushbutton. Time adjustable from 1 to 99 minutes. Switch-off early warning (no flickering) by dimming is adjustable from 1 to 3 minutes. Also for dimmable energy saving lamps ESL and 230 V LED lamps. **MIN** = Universal dimmer switch, switches when control voltage is applied to the minimum brightness setting. Maximum brightness is dimmed during the set dim time from 1 to 99 minutes. When the control voltage is interrupted, the device is switched off immediately, even during the dim time.

MMX = Same function as for **MIN**; when the control voltage is interrupted, dimming still continues until the set minimum brightness is reached. Then the device is switched off. **CG** = Clock with adjustable switch on/off times from 0.1 to 9.9 seconds. The maximum brightness is adjustable from 3 to 99%.

R = Switching relay with setting for Soft ON/OFF from 0.1 to 9.9 seconds. The maximum brightness is adjustable from 3 to 99%. **ON** = permanent ON. **OFF** = permanent OFF.

The dim position in % or the time lapse in minutes is indicated in the middle of the display. The expired, resettable switch-on time is indicated at the bottom of the display. Display menu guidance including language selection (German, English, French, Italian or Spanish) is described in the supplied operating instructions.

Typical connections

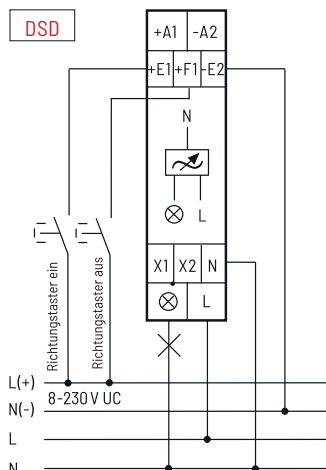
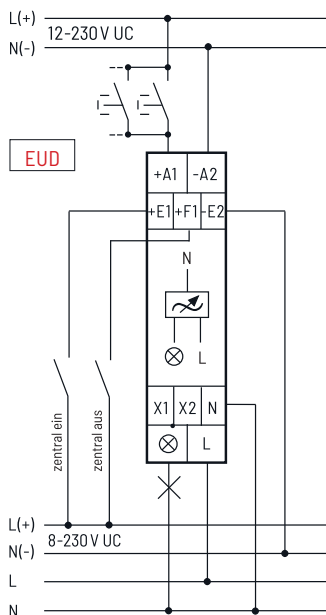

Manuals and documents in further languages:
<http://eltako.com/redirect/EUD12D-UC>

Technical data page 9-20.
 Housing for operating instructions
 GBA14 page 1-49 chapter 1.

EUD12D-UC	Multifunction universal dimmer switch, Power MOSFET up to 400 W	Art. No. 21100905	84,30 €/pc.
------------------	---	--------------------------	--------------------

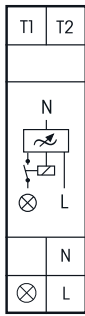

EUD12F



Universal dimmer switch. Power MOSFET up to 300 W. Automatic lamp detection. Standby loss 0.1 watt only. With adjustable minimum brightness and dimming speed. With switching operation for children's rooms and snooze function.

Modular device for DIN EN 60715 TH35 rail mounting. 1 module = 18 mm wide, 58 mm deep. Universal dimmer switch for lamps up to 300 W, depending on ventilation conditions, dimmable 230 V LED lamps and dimmable energy saving lamps (ESL) are also dependent on the lamp electronics.

Zero passage switching with soft start and soft OFF to protect lamps.

Supply voltage and switching voltage 230 V.

Short-time control commands switch on/off, permanent control varies the brightness to the maximum level.

An interruption of control changes the direction of dimming.

The setting of the brightness level is stored after switching off.

In case of a power failure the switching position and the brightness level are stored.

If applicable the dimmer will be switched on at the stored brightness level after the supply voltage is recovered.

Automatic electronic overload protection and over-temperature switch-off.

With integrated switching-off relay for the mains disconnection of switched circuits.

The control pushbutton(s) of the room are connected via low voltage control wires to the terminals T1 and T2 of the EUD12F (field-free internal DC voltage). The permanent power supply must be connected directly to a phase conductor **ahead** of the mains disconnection relay FR12-230V. Due to this, the complete function remains but the leads to the lamps is disconnected by means of the switching-off relay. A glow lamp current is not permitted.

The minimum brightness level (completely dimmed down) can be adjusted with **the upper rotary switch** % ⚙️, e.g. for dimmable energy saving lamps.

You can dim all lamp types in automatic mode.

Use the lower dimming speed rotary switch to set the dimming speed in seven steps in automatic mode.

+ESL is a convenience setting for energy saving lamps which must be switched on at high voltage for design reasons so that they can also be switched back on cold in dimmed state.

-ESL is a convenience setting for energy saving lamps which cannot be switched back on in dimmed state for design reasons.

This is why memory is switched off in this position. No inductive (wound) transformers may be used in +ESL and -ESL settings. In addition the maximum number of dimmable energy saving lamps may be lower than in automatic mode for design reasons.

With special switching operation for children's rooms: If the light is switched on by holding down the pushbutton, it starts at the lowest brightness level after approx. 1 second and dims up slowly as long as the pushbutton is held down without modifying the last stored brightness level.

Snooze function: With a double impulse the lighting is dimmed down from the current dimming position to the minimum brightness level and switched off. The current dimming position as well as the adjustable minimum brightness level determine the dimming time (max. = 60 minutes) which can be reduced as required. It can be switched off at any time by short-time control commands during the lighting is dimmed down. Holding down the pushbutton during the dimming down process dims up and stops the snooze function.

Function rotary switches

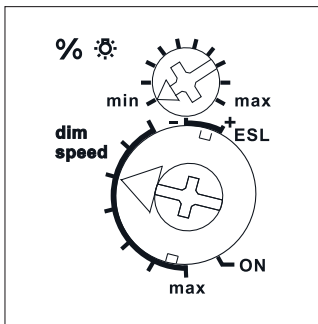

Standard setting ex works.

Typical connection

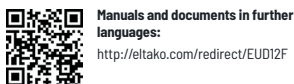
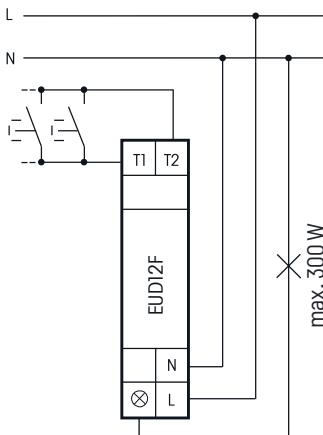

Technical data page 9-20.
Housing for operating instructions
GBA14 page 1-49 chapter 1.

Mixing of L loads (inductive loads, e.g. wound transformers) and C loads (capacitive loads, e.g. electronic transformers) is not permitted. R loads (ohmic loads, e.g. 230 V incandescent lamps and halogen lamps) may be added anytime.

Mixing of L loads and C loads is possible with the dimmer switch EUD12D (page 9-4) in connection with capacity enhancer LUD12 (page 9-7).

EUD12F	Universal dimmer switch, Power MOSFET up to 300 W and switching-off relay	Art. No. 21100830	86,40 €/pc.
---------------	---	--------------------------	--------------------

UNIVERSAL DIMMER SWITCH WITH ROTARY KNOB EUD12DK/800W-UC

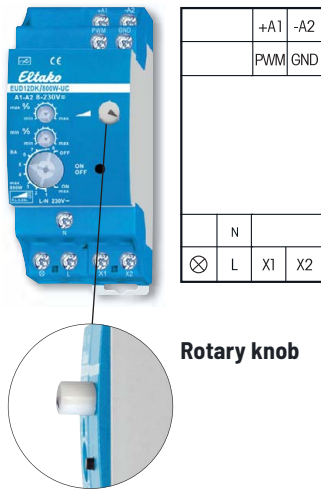

Rotary knob

EUD12DK/800W-UC



Universal dimmer switch with rotary knob, Power MOSFET up to 800 W. Automatic lamp detection. Standby loss 0.2 watt only. With adjustable minimum and maximum brightness.

Modular device for DIN EN 60715 TH35 rail mounting. 2 modules = 36 mm wide, 58 mm deep. Universal dimmer switch for lamps up to 800 W, depending on ventilation conditions, dimmable 230 V LED lamps and dimmable energy saving lamps (ESL) are also dependent on the lamp electronics and the dimming technology, **see technical data page 9-20.**

Up to 3600W with capacity enhancers LUD12 at the terminals X1 and X2.

Zero passage switching with soft start and soft OFF to protect lamps.

Universal control voltage input 8 to 230 V UC, electrically isolated from the 230 V supply voltage and switching voltage. No minimum load required.

Alternatively, PWM control with 10-24 V DC at the PWM and GND connections.

The setting of the brightness level is stored after switching off (Memory).

In case of a power failure the switching position and the brightness level are stored.

If applicable the dimmer will be switched on at the stored brightness level after the supply voltage is recovered.

Automatic electronic overload protection and over-temperature switch-off.

Maximum brightness (fully dimmed up) is adjustable using the upper % rotary switch.

Use the middle % rotary switch to set the minimum brightness (fully dimmed down).

The lower rotary switch sets the operating mode:

ON: Permanent ON at maximum brightness.

Pos. 1 is an AUTO position and allows the dimming of all lamp types. Switch on and off using pushbutton on the device and/or pushbutton connected to +A1/-A2. Dimming via rotary knob.

Pos. 2 is a comfort setting for dimmable 230 V LED lamps which cannot be dimmed down far enough on AUTO (phase cut-off) due to the design and must therefore be forced at phase control. Switch on and off using pushbutton on the device and/or pushbutton connected to +A1/-A2. Dimming via rotary knob.

Pos. 3 is a comfort setting for energy saving lamps which must be switched on at a higher voltage so that they can be safely switched on cold when they are dimmed down. Switch on and off using pushbutton on the device and/or pushbutton connected to +A1/-A2. Dimming via rotary knob.

Pos. 4 is an AUTO position and allows the dimming of all lamp types. Switch on and off using switch connected to +A1/-A2. Dimming via rotary knob.

Pos. 5 is a comfort setting for dimmable 230 V LED lamps which cannot be dimmed down far enough on AUTO (phase cut-off) due to the design and must therefore be forced at phase control. Switch on and off using switch connected to +A1/-A2. Dimming via rotary knob.

Pos. 6 is a comfort setting for energy saving lamps which must be switched on at a higher voltage so that they can be safely switched on cold when they are dimmed down. Switch on and off using switch connected to +A1/-A2. Dimming via rotary knob.

Pos. 7 is an AUTO position and allows the dimming of all lamp types. Switch on and off and dimming with PWM activation.

Pos. 8 is a comfort setting for dimmable 230 V LED lamps which cannot be dimmed down far enough on AUTO (phase cut-off) due to the design and must therefore be forced at phase control. Switch on and off and dimming with PWM activation.

In positions 2, 3, 5, 6 and 8 no inductive (wound) transformers should be used.

OFF: Permanent OFF.

The LED under the upper rotary switch lights up when the lamp is switched on.

Function rotary switches

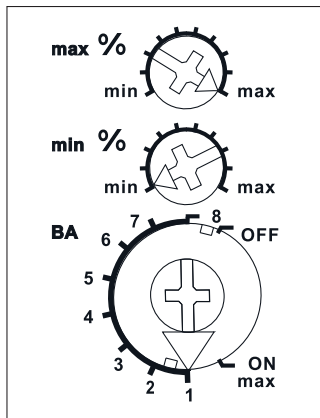

Standard setting ex works.

Typical connection

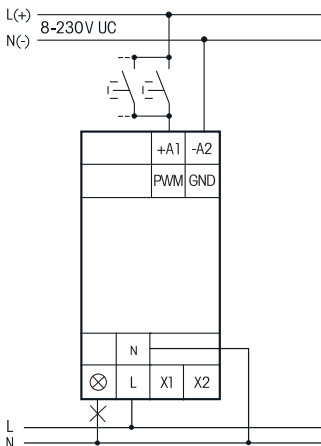

Manuals and documents in further languages:
http://eltako.com/redirect/EUD12DK*800W-UC

Technical data page 9-20.
 Housing for operating instructions
 GBA14 page 1-49 chapter 1.

EUD12DK/800W-UC	Universal dimmer switch, Power MOSFET up to 800 W	Art. No. 21100810	79,80 €/pc.
------------------------	---	--------------------------	--------------------



Function rotary switch

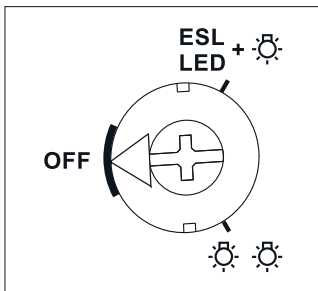

Standard setting ex works.

The switching mode "one lamp" (☼) or "additional lamps" (☼☼) is set with a rotary switch on the front.

This setting must be same as the actual installation, otherwise there is a risk of destruction of the electronics.

Alternative setting for 230 V LED and ESL when the universal dimmer switch in operated in the LED or ESL comfort settings. See page 9-8.



Manuals and documents in further languages:
<http://eltako.com/redirect/LUD12-230V>

Technical data page 9-20.
 Housing for operating instructions
 GBA14 page 1-49 chapter 1.

LUD12-230V



Capacity enhancer for universal dimmer switches. Power MOSFET up to 400 W. Standby loss 0.1 watt only.

Modular device for DIN EN 60715 TH35 rail mounting. 1 module = 18 mm wide, 58 mm deep. Capacity enhancers LUD12-230V can be connected to the universal dimmer switches EUD12D, SUD12 (1-10 V input) and the multifunction time relay MFZ12PMD. By this the switching capacity for **one lamp** will be increased up to 200 W or **alternatively for additional lamps** up to 400 W per each capacity enhancer. Dimmable 230 V LED lamps and dimmable energy saving lamps are also dependent on the lamp electronics. Both switching modes for increase of capacity can be executed simultaneously. Automatic lamp detection in the "Capacity increase **with additional lamps**" setting. Supply voltage 230 V.

Automatic electronic overload protection and over-temperature switch-off. In the mode "Increase of capacity with additional lamps" the kind of load of a capacity enhancer LUD12-230V can vary from the kind of load of the universal impulse dimmer switch.

Therefore it is possible to mix L loads and C loads.

Increase of capacity for one lamp (☼), LED and ESL see next page

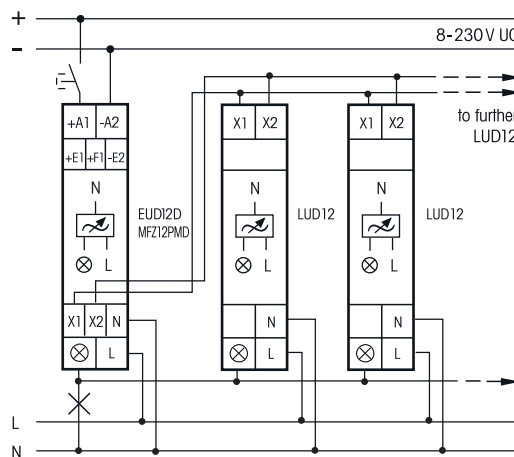

EUD12D and MFZ12PMD:
 1.-9. LUD12 + up to 200 W each

Increase of capacity with additional lamps (☼☼), LED and ESL see next page

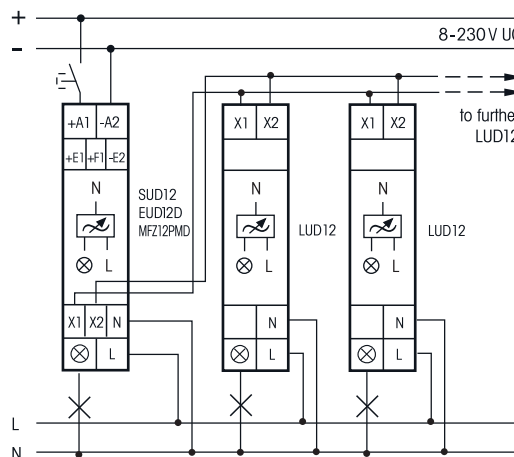

EUD12D, SUD12 and MFZ12PMD:
 1.-8. LUD12 + up to 400W each

LUD12-230V	Capacity enhancer for universal dimmer switches, Power MOSFET up to 400 W	Art. No. 21100805	73,80 €/pc.
-------------------	---	--------------------------	--------------------

LUD12-230V



Function rotary switch

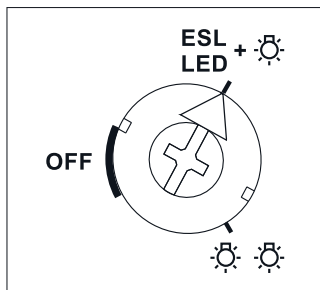

Standard setting ex works.

This setting must be made on the front panel of 230 V LED lamps and ESL if the universal dimmer switch is operated in the LED or ESL comfort settings. Also for capacity increase with additional lamps.

Otherwise there is a risk of destruction of the electronics.



Manuals and documents in further languages:
<http://eltako.com/redirect/LUD12-230V>

Technical data page 9-20.
 Housing for operating instructions
 GBA14 page 1-49 chapter 1.

Capacity increase with capacity enhancer LUD12 for dimmable 230V LED lamps and dimmable energy saving lamps ESL in the LED and ESL comfort settings.

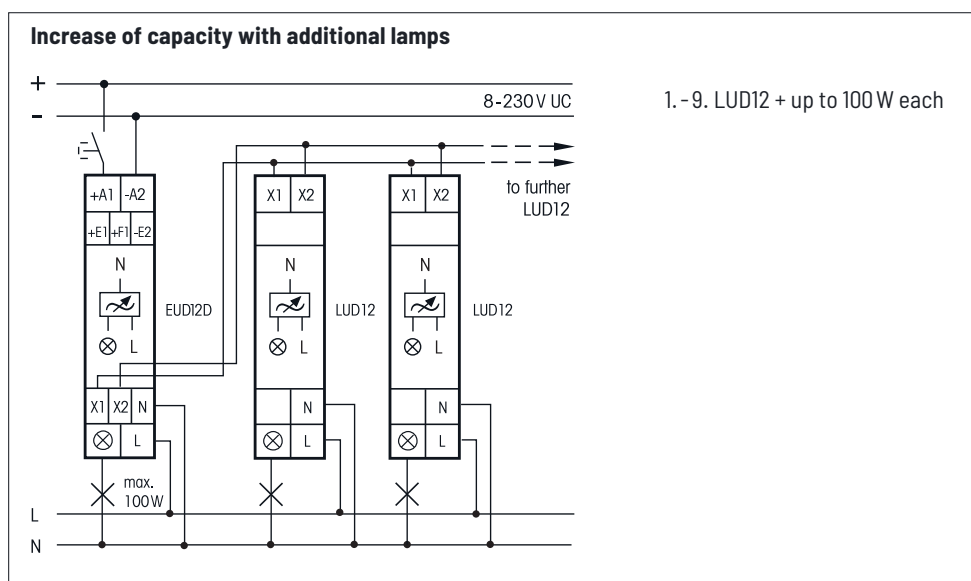
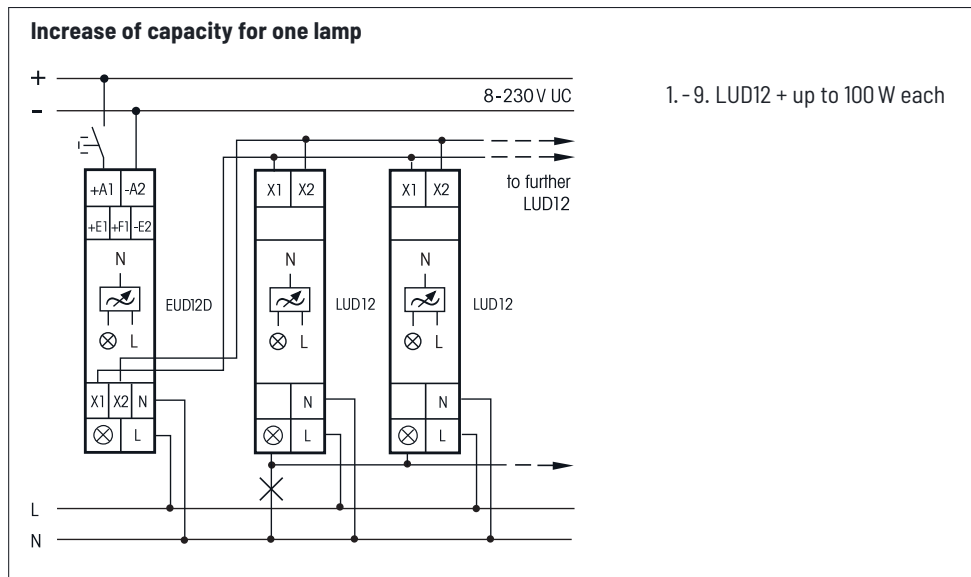

LUD12-230V	Capacity enhancer for universal dimmer switches, Power MOSFET up to 400 W	Art. No. 21100805	73,80 €/pc.
-------------------	---	--------------------------	--------------------



MOD12D-UC

Power MOSFET up to 300 W. Standby loss 0.3 watt only. Minimal speed, maximum speed and dimming speed are adjustable.

Modular device for DIN EN 60715 TH35 rail mounting.
1 module = 18 mm wide, 58 mm deep.

Motor dimmer with phase control for L loads up to 300 W, depending on ventilation conditions. Only 1 fan motor should be connected.

Universal control voltage 12 to 230 V UC and additionally the universal voltage control inputs 8 to 230 V UC central ON and central OFF. The control inputs are electrically isolated from the 230 V supply voltage and switching voltage.

Switching in zero crossing and switch-on at increased speed.

If there is a power failure, the switch position and the speed level are saved. The device can be switched on when the power supply is restored.

Automatic electronic overload protection and over-temperature switch-off.

Enter the 6 functions and times using the MODE and SET keys as described in the operator manual.

The functions and times are indicated in the LC display. Other features include language selection and keylock.

The total switch-on time is added and indicated in the bottom line of the display. It can be reset to zero. The top line shows the parameters during the setting procedure and the active function in service. The left arrow indicates the switch position 'ON' and the right arrow shows the keylock function when applied. During the setting procedure, the middle line shows the parameters set. In service, the middle line indicates the speed between 10 and 99 for the MOD and DSD functions or the remaining time in minutes for the Udo and ODT functions.

MOD = Motor dimmer with settings for dimming speed DSP, minimum speed MI%, maximum speed MA%, memory function MEM+ and selection of the central control inputs ON and/or OFF when activated or deactivated. Short commands switch on/off, permanent activation changes speed. An interruption in activation changes the dimming direction.

DSD = Motor dimmer with activation with two direction buttons for dimming direction. Setting the dimming speed DSP, minimum speed MI%, maximum speed MA% and memory function MEM+. When activation takes place via +E1, a short command switches on. Permanent activation dims up to maximum speed. A double-click immediately dims to maximum speed. When activation takes place via +F1, a short command switches off. Permanent activation dims down to minimum speed. No central control function.

Udo = Motor dimmer as for MOD function with manual on/off. In addition, a time delay time TIM can be set from 1 to 99 minutes. When the time delay expires, the device switches off. Central ON has priority over Central OFF.

ODT = Motor dimmer with run-on switch function with adjustable speed SP%, response lag AV adjustable from 1 to 99 minutes and time delay RV adjustable from 1 to 99 minutes. When the control voltage is applied, the device switches on after the AV time expires. When the control voltage cuts off, the RV time begins. When the RV time expires, the device switches off.

No central control function.

ON = Permanent ON at maximum speed, **OFF** = Permanent OFF.

Press MODE and SET briefly and simultaneously to activate the keylock. Then press SET to confirm the flashing LCK. Press MODE and SET simultaneously for 2 seconds to deactivate keylock. Then press SET to confirm the flashing UNL.

Typical connections

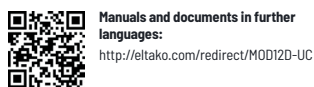
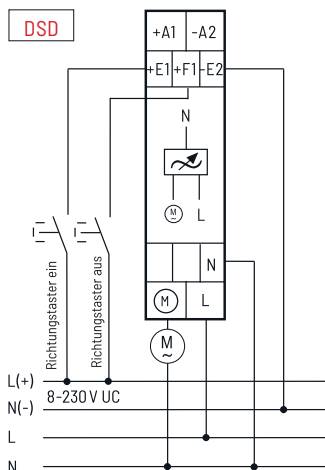
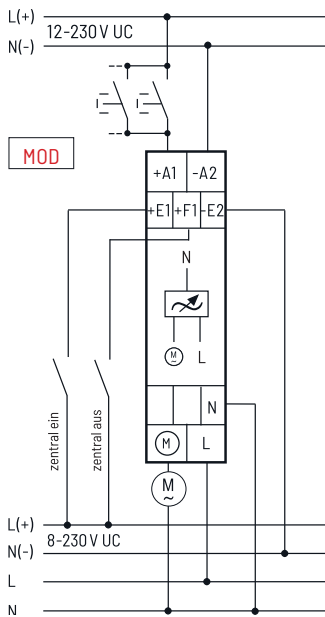

Technical data page 9-20.
Housing for operating instructions
GBA14 page 1-49 chapter 1.

MOD12D-UC	Digitally adjustable motor dimmer, Power MOSFET up to 300 W	Art. No. 21100906	84,40 €/pc.
------------------	---	--------------------------	--------------------

FULLY ELECTRONIC MULTIFUNCTION TIME RELAY MFZ12PMD-UC WITH 18 FUNCTIONS

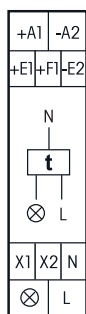

MFZ12PMD-UC



Power MOSFET with almost unlimited number of circuits up to 400 W. Automatic lamp detection. Standby loss 0.3 watt only. Dim down to minimum brightness and up to maximum brightness and Soft ON / Soft OFF are also adjustable for lamp circuit.

Modular device for DIN EN 60715 TH35 rail mounting. 1 module = 18 mm wide, 58 mm deep.

Digitally adjustable and fully electronic multifunction time relay for lamps up to 400 W dependent on ventilation conditions. Dimmable 230V LED lamps and dimmable energy saving lamps (ESL) are also dependent on the lamp electronics and the dimming technology, **see technical data page 9-20.**

If **minimum brightness** is not set to 0, the circuit is not switched off but dimmed down to the set percentage.

Up to 3600 W with capacity enhancers LUD12-230V (description page 9-7) at the terminals X1 and X2.

Universal control voltage 12 to 230 V UC and additionally the universal voltage control inputs 8 to 230 V UC central ON and central OFF. The control inputs are electrically isolated from the supply voltage and switching voltage.

Zero passage switching to protect lamps.

Glow lamp current up to 5 mA starting at 110 V.

Automatic electronic overload protection and overtemperature switch-off.

Enter both the functions and the times using the two buttons MODE and SET. The functions and times are indicated digitally on an LC display. The time can be set by entering all values within the preselected time scale (0.1 to 9.9 or 1 to 99 seconds, minutes or hours). The longest time is 99 hours. This permits 600 time settings. The time(s) entered is (are) permanently displayed digitally.

Settable functions (description page 13-11): **RV** = release delay, **AV** = operate delay, **AV+** = additive operate delay, **TI** = clock generator starting with impulse, **TP** = clock generator starting with pause, **IA** = impulse-controlled operate delay, **IF** = pulse shaper, **EW** = fleeting NO contact, **AW** = fleeting NC contact, **EAW** = fleeting NO contact and fleeting NC contact, **ARV** = operate and release delay, **ARV+** = additive operate and release delay, **ES** = impulse switch, **SRV** = release-delay impulse switch, **ESV** = impulse switch with release delay and switch-off early-warning function, **ER** = relay, **ON** = permanent ON, **OFF** = permanent OFF. With TI, TP, IA, EAW, ARV and ARV+ functions, a different second time can be entered also with different time ranges.

Setting the times and functions: The LCD component to be changed is selected by pressing the MODE key. The component accessed flashes. Press the SET key to change the component accessed. This may be the function, the time ranges, time T1 or time T2 (on TI, TP, IA, EAW, ARV and ARV+ only). Pressing the MODE key terminates each input. Once the time has been set with MODE, no more components are flashing. The timing relay is now ready to operate. Press the MODE key again to restart the input cycle. All the entered parameters are retained if they are not changed using SET. 25 sec. after the last operation and if the component still flashes the input cycle is automatically terminated and the previously made changes lapse.

Setting additional parameters valid for all functions: when you press the MODE button for longer than 2 seconds, you access the submenu. Press the SET button to select the parameter you want to change. Then confirm by pressing MODE. Press SET to enter the parameter and confirm by pressing MODE. After the 'LED' submenu, you return automatically to the main menu.

MIN = Minimum brightness in OFF state settable to 0 and from 10 to 89 (%), factory setting = 0.

MAX = Maximal brightness in ON state settable from 10 to 99 (%), factory setting = 99. MAX must be at least 10 divisions above MIN.

RMP = Switch ON/OFF ramp (soft ON and soft OFF) adjustable from 0 = 10 ms to 99 = 1 s, factory setting = 0.

LED = LED+ for dimmable 230 V LED lamps which cannot be dimmed down far enough in automatic mode (trailing edge control) for design reasons and must therefore be forced by phase control. Enabled by pressing MODE; factory setting = LED without +.

Functions of the LC display: if you selected the functions ON or OFF, no time is displayed. Instead an arrow indicates either ON or OFF. In all other functions the set time(s), the function abbreviation and an arrow next to ON and OFF display the switching position. The clock symbol flashes while the set time is elapsing and the remaining time is shown.

Safety in the event of a power failure: The set parameters are stored in an EEPROM and are therefore immediately available again when the power supply is restored after a power failure.

Typical connection

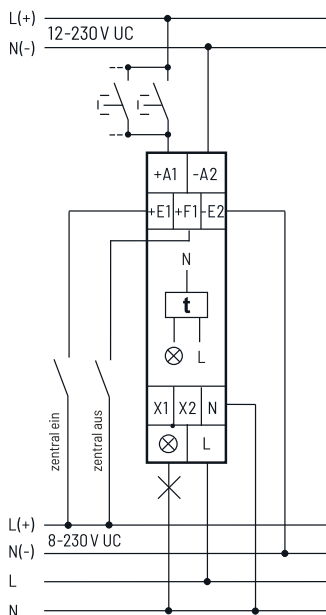

Manuals and documents in further languages:
<http://eltako.com/redirect/MFZ12PMD-UC>

Technical data page 9-20.
Housing for operating instructions
GBA14 page 1-49 chapter 1.

MFZ12PMD-UC	Fully electronic multifunction time relay, Power MOSFET up to 400 W	Art. No. 23001006	88,10 €/pc.
--------------------	--	--------------------------	--------------------

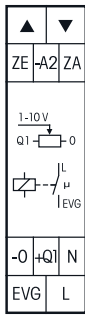

SDS12/1-10V



1 NO contact not potential free 600 VA and 1-10 V control output 40 mA. Only 0.5 watt standby loss. With adjustable minimum brightness and dimming speed. With switching operation for children's rooms and snooze function.

Modular device for DIN-EN 60715 TH35 rail mounting.
1 modul = 18 mm wide, 58 mm deep.

Zero passage switching with soft ON and soft OFF to protect lamps.

Also adapted for LED driver with 1-10 V passive interface, without voltage source up to 0.6 mA, above this value an additional voltage source is necessary.

Universal control voltage 8 to 230 V UC, local and central on/off with same potential.

Supply voltage 230 V electrically isolated.

State-of-the-art hybrid technology combines advantages of nonwearing electronic control with high capacity of special relays.

The brightness level is stored on switch-off (Memory).

In case of a power failure the switch position and the brightness stage are stored and may be switched on when the power supply is restored.

The minimum brightness (fully dimmed) is adjustable with the upper % rotary switch.

At the same time, you define whether the children's room function and the snooze function are active (+KI +SL).

The dimming speed is adjustable **using the lower dimming speed rotary switch.**

The load is switched on and off by a bistable relay at output EVG (electronic ballast units). Switching capacity for fluorescent lamps or LV halogen lamps with electronic ballast units 600 VA.

By using a bistable relay coil power loss and heating is avoided even in the on mode. After installation, wait for short automatic synchronisation before the switched consumer is connected to the mains.

Either direction pushbuttons can be connected to ▲ ▼ or these terminals are bridged and a pushbutton is connected as universal pushbutton. As direction pushbutton ▲ is 'switch on and dim up' and ▼ is 'switch off and dim down'. A double click at ▲ triggers the automatic updimming until full brightness with dim speed. A double click at ▼ triggers the snooze function. The children's room function is realized with the pushbutton at ▲.

As a universal pushbutton, change the direction by briefly releasing the pushbutton.

Switching operation for children's rooms KI (universal pushbutton or direction pushbutton ▲):

If the light is switched on by holding down the pushbutton, it starts at the lowest brightness level after approx. 1 second and dims up slowly as long as the pushbutton is held down without modifying the last stored brightness level.

Snooze function SL (universal pushbutton or direction pushbutton ▼): With a double impulse the lighting is dimmed down from the current dimming position to the minimum brightness level and switched off.

The current dimming position as well as the adjustable minimum brightness level determine the dimming time (max. = 60 minutes) which can be reduced as required. It can be switched off at any time by short-time control commands during the lighting is dimmed down. Holding down the pushbutton during the dimming down process dims up and stops the snooze function.

Function rotary switches

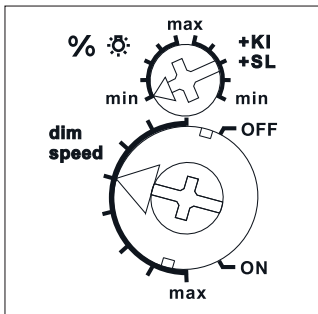

Standard setting ex works.

Typical connections

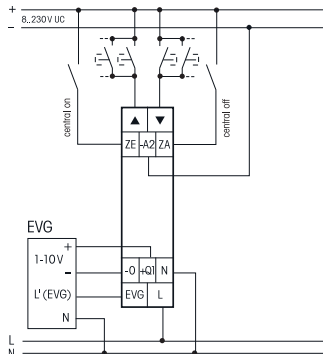

with direction pushbutton

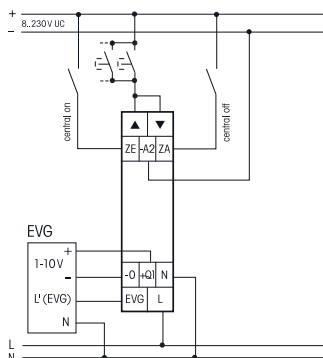

with universal pushbutton

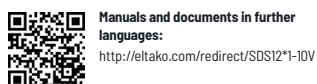

Technical data page 9-20.
Housing for operating instructions
GBA14 page 1-49 chapter 1.

Recommended retail prices excluding VAT.

SDS12/1-10V	1-10 V control dimmer switch for electronic ballast units, 1 NO contact 600 VA	Art. No. 21100800	71,30 €/pc.
-------------	--	-------------------	-------------

1-10V CONTROLLER SUD12/1-10V FOR UNIVERSAL DIMMER SWITCHES

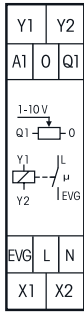

SUD12/1-10V



1 NO contact potential free 600 VA and 1-10 V control output 40 mA. Standby loss 0.5 watt only.

Modular device for DIN-EN 60715 TH35 rail mounting. 1 module = 18 mm wide, 58 mm deep.
State-of-the-art hybrid technology combines advantages of nonwearing electronic control with high capacity of special relays.

The controller SUD12 can be used in two different modes:

Mode 1-10 V output

In this mode electronic ballast units and transformers with a 1-10 V interface up to a total control current of 40 mA can be controlled when connected to an universal dimmer switch EUD12D or MFZ12PMD. The EUD12D or the MFZ12PMD is controlled with pushbuttons at the universal control voltage input locally or centrally. The SUD12 converts the dimmer signals from Y1/Y2 to the 1-10 V output 0/Q1 for the interface.

It switches the electronic ballast with a bistable relay at the output EVG (electronic ballast units). **Zero passage switching to protect contacts.** The switching capacity for fluorescent lamps or low voltage halogen lamps with electronic ballast is up to 600 VA.

By using a bistable relay coil power loss and heating is avoided even in the on mode.

The switched load may not be connected to the mains before the short automatic synchronisation after installation has terminated.

At the same time a directly dimmable lamp can be connected to the dimmer switch EUD12D. Furthermore the dimmer switch EUD12D or MFZ12PMD can be expanded with capacity enhancers LUD12 for directly dimmable lamps as described on page 9-7.

Mode 1-10 V output

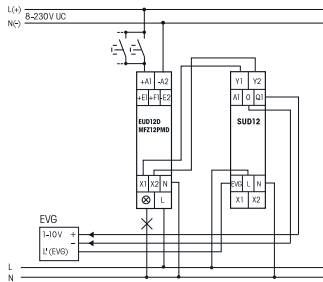

Mode 1-10 V input

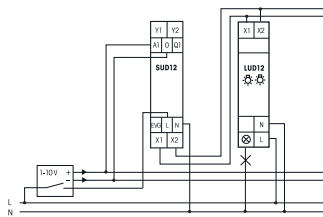

Manuals and documents in further languages:
http://eltako.com/redirect/SUD12*1-10V

Technical data page 9-20.
Housing for operating instructions
GBA14 page 1-49 chapter 1.

Mode 1-10 V input

In this mode the output of a 1-10 V controller can be converted at A1/0 into a direct dimming function when connected to a capacity enhancer LUD12 at terminals X1/X2. The closing operation and the opening operation is also carried out externally at L of the SUD12.

The rotary switch of the LUD12 must be adjusted to the setting  (additional lamps).

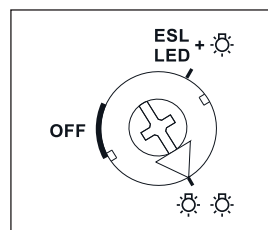

Further capacity enhancers LUD12 in the mode "increase of capacity with additional lamps" can be connected to the controller SUD12 as described on page 9-8.

A 100 K potentiometer for brightness control may also be directly connected to the control input A1/0. If the input A1/0 is disconnected the LUD12 dims to maximum brightness.

SUD12/1-10V	1-10 V controller for universal dimmer switches, 1 NO contact 600 VA	Art. No. 21100802	68,00 €/pc.
--------------------	---	--------------------------	--------------------

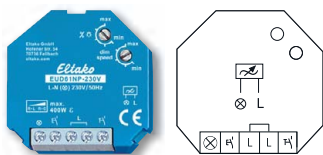

EUD61NP-230V



Without N connection, POWER MOSFET up to 400 W. Standby loss 0.5 watt only. With control inputs for pushbutton light switches and light switches. With adjustable minimum brightness and dimming speed.

Function rotary switches

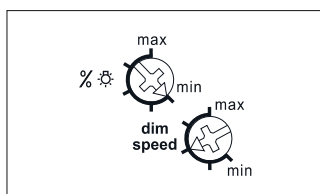

Standard setting ex works.

Typical connection

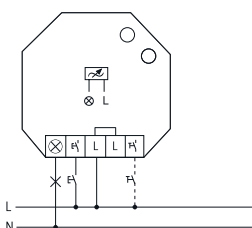

Control by pushbutton switches or light switches.



Manuals and documents in further languages:
<http://eltako.com/redirect/EUD61NP-230V>

Technical data page 9-20.

Built-in device for installation. 45 mm long, 45 mm wide, 18 mm deep.

Universal dimmer switch for R, L and C loads up to 400 watt, depending on ventilation conditions. Automatic detection of load R+L or R+C.

Not compatible with 230 V LED and energy saving lamps, please use the EUD61NPL or the dimmer with N connection: EUD61NPN.

Zero passage switching with soft start and soft OFF to protect lamps.

Control voltage 230 V. Min. load 20 W.

Short-time control commands switch on/off, permanent control varies the brightness up to the maximum level. A short interruption of control changes the direction of dimming.

The brightness level is stored after switching off.

In case of a power failure the switching position and the brightness level are stored.

If applicable the dimmer will be switched on at the stored brightness level after the supply voltage is recovered.

Automatic electronic overload protection and over-temperature switch-off.

The minimum brightness level (completely dimmed down) can be adjusted **with the upper rotary switch** %☼.

The dimming speed can be adjusted **with the lower dimming speed rotary switch**. Simultaneously the soft on and soft off period is changed.

If light switches cannot be replaced by pushbutton light switches, there is a separate control input for light switches. If the switch is opened briefly after closing, the light is dimmed until the next time it is opened again briefly. The dimming direction changes automatically at both peaks. The dimming direction can also be changed by opening the switch briefly twice.

Switching operation for children's rooms (only if controlled by pushbutton light switch): If the light is switched on by holding down the pushbutton, it starts at the lowest brightness level after approx. 1 second and dims up slowly as long as the pushbutton is held down without modifying the last stored brightness level.

Snooze function (only if controlled by pushbutton light switch): With a double impulse the lighting is dimmed down from the current dimming position to the minimum brightness level and switched off. The current dimming position as well as the adjustable minimum brightness level determine the dimming time (max. = 60 minutes) which can be reduced as required. It can be switched off at any time by short-time control commands during the lighting is dimmed down. Holding down the pushbutton during the dimming down process dims up and stops the snooze function.

Without N connection, therefore suitable for mounting directly behind the pushbutton light switch or light switch, even if no N wire is available.

Mixing of L loads (inductive loads, e.g. wound transformers) and C loads (capacitive loads, e.g. electronic transformers) is not permitted. R loads (ohmic loads, e.g. 230 V incandescent lamps and halogen lamps) may be added anytime.

EUD61NP-230V	Universal dimmer switch, Power MOSFET up to 400 W	Art. No. 61100830	71,20 €/pc.
---------------------	---	--------------------------	--------------------

UNIVERSAL DIMMER SWITCH EUD61NPL-230V WITHOUT N CONNECTION, ESPECIALLY FOR LED

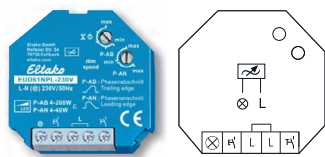

EUD61NPL-230V



Without N connection, POWER MOSFET up to 200 W. Standby loss 0.5 watt only. With control inputs for pushbutton light switches and light switches. With adjustable minimum brightness, dimming technology and dimming speed.

Function rotary switches

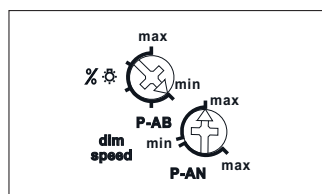

Standard setting ex works.

Typical connection

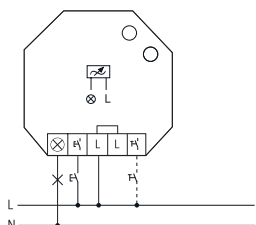

Control by pushbutton switches or light switches.



Manuals and documents in further languages:
<http://eltako.com/redirect/EUD61NPL-230V>

Technical data page 9-20.

For installation. 45 mm long, 45 mm wide, 18 mm deep.

Universal dimmer switch for R and C loads up to 200 W, depending on ventilation conditions.

Dimmable 230 V LED lamps and energy saving lamps ESL in 'trailing edge' mode up to 200 W or up to 40 W in 'leading edge' mode, depending on ventilation conditions.

If 230 V LED lamps are lightly glowing when they are turned off, a GLE base load must be installed parallel to the lamp.

It is not permitted to connect L loads (inductive loads, like wounded transformers).

Zero passage switching with soft start and soft OFF to protect lamps.

Control voltage, supply voltage and switching voltage 230 V. Min. load 4 W.

Short-time control commands switch on/off, permanent control varies the brightness up to the maximum level. A short interruption of control changes the direction of dimming.

The brightness level is stored after switching off (memory). It is possible to deactivate the memory function by turning 3 times the upper rotary switch to the right stop (max), then it is compatible with ESL. To re-activate the memory function (factory setting), turn the upper rotary switch 3 times to the left stop (min).

In case of a power failure the switching position and the brightness level are stored, and will switch on after the failure if applicable.

Automatic electronic overload protection and over-temperature switch-off.

The minimum brightness level (completely dimmed down) can be adjusted **with the upper rotary switch** % ⚙️.

The lower rotary switch allows to choose between the both dimming technologies, P-AN leading or P-AB trailing edge and to change the dimming speed. Simultaneously the duration of soft on and soft off will be adjusted.

If light switches cannot be replaced by pushbutton light switches, there is a separate control input for light switches:

If the switch is opened briefly after closing, the light is dimmed until the next time it is opened again briefly. The dimming direction changes automatically at both peaks. The dimming direction can also be changed by opening the switch briefly twice.

Switching operation for children's rooms (only if controlled by pushbutton light switch): If the light is switched on by holding down the pushbutton, it starts at the lowest brightness level after approx. 1 second and dims up slowly as long as the pushbutton is held down without modifying the last stored brightness level.

Snooze function (only if controlled by pushbutton light switch): With a double impulse the lighting is dimmed down from the current dimming position to the minimum brightness level and switched off. The current dimming position as well as the adjustable minimum brightness level determine the dimming time (max. = 60 minutes) which can be reduced as required.

It can be switched off at any time by short-time control commands during the lighting is dimmed down. Holding down the pushbutton during the dimming down process dims up and stops the snooze function.

Without N connection, therefore suitable for mounting directly behind the pushbutton light switch or light switch, even if no N wire is available.

EUD61NPL-230V	Universal dimmer switch without N connection, especially for LED Power, MOSFET up to 200 W	Art. No. 61100832	68,40 €/pc.
----------------------	--	--------------------------	--------------------

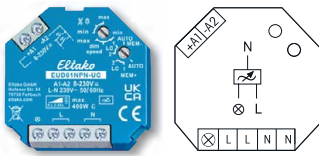

EUD61NPN-UC



Universal dimmer switch. Power MOSFET up to 400 W. Automatic lamp detection. Standby loss 0.2 watt only. With adjustable minimum brightness or dimming speed. With switching operation for children's rooms and snooze function.

Function rotary switches

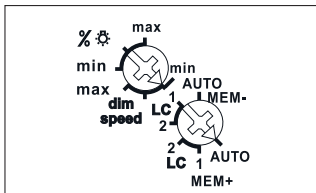

Standard setting ex works.

Typical connection

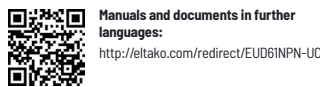
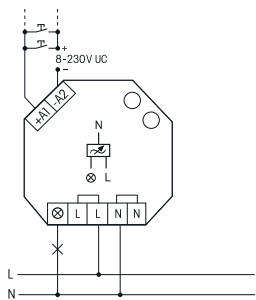

For installation. 45 mm long, 45 mm wide, 18 mm deep.

Universal dimmer switch for lamps up to 400 watts, depending on ventilation conditions. Dimmable 230 V LED lamps and dimmable energy saving lamps ESL dependent on the lamps electronics and the dimming technology, **see technical data page 9-20.**

Switching with soft start and soft OFF to protect lamps.

Universal control voltage input 8 to 230 V UC, electrically isolated from the 230 V ~ 50/60 Hz supply voltage and switching voltage. No minimum load required.

Short-time control commands switch on/off, permanent control varies the brightness to the maximum level. An interruption of control changes the direction of dimming.

The setting of the brightness level is stored after switching off (Memory).

In case of a power failure the switching position and the brightness level are stored. If applicable the dimmer will be switched on at the stored brightness level after the supply voltage is recovered.

Automatic electronic overload protection and over-temperature switch-off.

With the top rotary switch %/dim speed either the minimum brightness level (completely dimmed down) or the dim speed can be adjusted. The duration of soft-on and soft-off will be changed with the dimming speed.

The lower rotary switch determines in operation whether the automatic lamp detection 'AUTO' should act, or one of the special Comfort settings LC1 or LC2.

If the **MEM+** setting range is selected, the **memory function** is active and the last brightness level set is saved when the device is switched off. If the setting range **MEM-** is selected, the memory function is switched off and it is always switched on with maximum brightness. Dimmable energy-saving lamps must be operated on AUTO and MEM-.

AUTO allows the dimming of all lamp types.

LC1 is a comfort position for dimmable 230 V LED lamps which are not being dimmed down enough when set to AUTO (trailing phase angle) dependent on the construction and must therefore be forced to leading phase angle.

LC2 like LC1, but with different dimming curves.

In positions LC1 and LC2 no inductive (wound) transformers should be used. In addition, the maximum number of dimmable LED lamps can be lower than in the AUTO position dependent on the construction.

With special switching operation for children's rooms: If the light is switched on by holding down the pushbutton, it starts at the lowest brightness level after approx. 1 second and dims up slowly as long as the pushbutton is held down without modifying the last stored brightness level.

Snooze function: With a double impulse the lighting is dimmed down from the current dimming position to the minimum brightness level and switched off. The current dimming position as well as the adjustable minimum brightness level determine the dimming time (max. = 60 minutes) which can be reduced as required. It can be switched off at any time by short-time control commands during the lighting is dimmed down. Holding down the pushbutton during the dimming down process dims up and stops the snooze function.

Mixing of L loads (inductive loads, e.g. wound transformers) and C loads (capacitive loads, e.g. electronic transformers) is not permitted. R loads (ohmic loads, e.g. 230 V incandescent lamps and halogen lamps) may be added anytime.

Technical data page 9-20.

EUD61NPN-UC	Universal dimmer switch, Power MOSFET up to 400 W	Art. No. 61100801	67,40 €/pc.
--------------------	---	--------------------------	--------------------

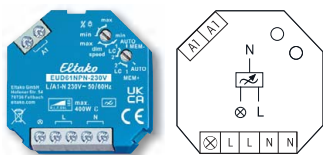

EUD61NPN-230V



Universal dimmer switch. Power MOSFET up to 400 W. Automatic lamp detection. Standby loss 0.2 watt only. With adjustable minimum brightness or dimming speed. With switching operation for children's rooms and snooze function.

Function rotary switches

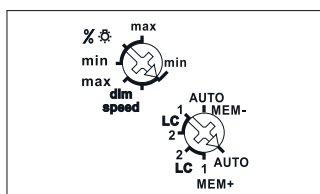

Standard setting ex works.

Typical connection

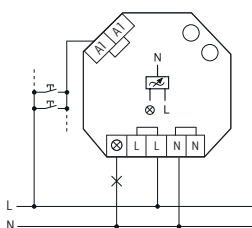

Manuals and documents in further languages:
<http://eltau.com/redirect/EUD61NPN-230V>

Technical data page 9-20.

For installation. 45 mm long, 45 mm wide, 18 mm deep.

Universal dimmer switch for lamps up to 400 watts, depending on ventilation conditions. Dimmable 230 V LED lamps and dimmable energy saving lamps ESL dependent on the lamps electronics and the dimming technology, **see technical data page 9-20.**

Switching with soft start and soft OFF to protect lamps.

Control voltage, supply voltage and switching voltage 230 V ~ 50/60 Hz.

No minimum load required.

Short-time control commands switch on/off, permanent control varies the brightness to the maximum level. An interruption of control changes the direction of dimming.

The setting of the brightness level is stored after switching off (Memory).

In case of a power failure the switching position and the brightness level are stored. If applicable the dimmer will be switched on at the stored brightness level after the supply voltage is recovered.

Automatic electronic overload protection and over-temperature switch-off.

With the top rotary switch %/dim speed either the dim speed can be adjusted or the minimum brightness level (completely dimmed down). The duration of soft-on and soft-off will be changed with the dimming speed.

The lower rotary switch determines in operation whether the automatic lamp detection 'AUTO' should act, or one of the special Comfort settings LC1 or LC2.

If the **MEM+** setting range is selected, the **memory function** is active and the last brightness level set is saved when the device is switched off. If the setting range **MEM-** is selected, the memory function is switched off and it is always switched on with maximum brightness. Dimmable energy-saving lamps must be operated on AUTO and MEM-.

AUTO allows the dimming of all lamp types.

LC1 is a comfort position for dimmable 230 V LED lamps which are not being dimmed down enough when set to AUTO (trailing phase angle) dependent on the construction and must therefore be forced to leading phase angle.

LC2 like LC1, but with different dimming curves.

In positions LC1 and LC2 no inductive (wound) transformers should be used. In addition, the maximum number of dimmable LED lamps can be lower than in the AUTO position dependent on the construction.

With special switching operation for children's rooms: If the light is switched on by holding down the pushbutton, it starts at the lowest brightness level after approx. 1 second and dims up slowly as long as the pushbutton is held down without modifying the last stored brightness level.

Snooze function: With a double impulse the lighting is dimmed down from the current dimming position to the minimum brightness level and switched off. The current dimming position as well as the adjustable minimum brightness level determine the dimming time (max. = 60 minutes) which can be reduced as required. It can be switched off at any time by short-time control commands during the lighting is dimmed down. Holding down the pushbutton during the dimming down process dims up and stops the snooze function.

Mixing of L loads (inductive loads, e.g. wound transformers) and C loads (capacitive loads, e.g. electronic transformers) is not permitted. R loads (ohmic loads, e.g. 230 V incandescent lamps and halogen lamps) may be added anytime.

EUD61NPN-230V	Universal dimmer switch, Power MOSFET up to 400 W	Art. No. 61100802	68,70 €/pc.
----------------------	---	--------------------------	--------------------

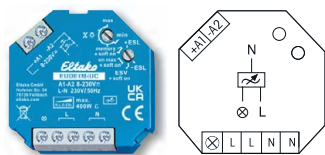

EUD61M-UC



Universal dimmer switch. Power MOSFET up to 400 W. Automatic lamp detection. Standby loss 0.1 watt only. With adjustable minimum brightness. With switching operation for children's rooms and snooze function.

Function rotary switches

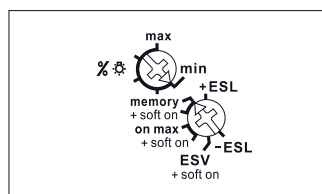

Standard setting ex works.

Typical connection

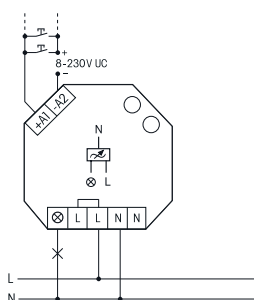

Manuels and documents in further languages:
<http://eltako.com/redirect/EUD61M-UC>

Built-in device for installation. 45 mm long, 45 mm wide, 18 mm deep.

Universal dimmer switch for lamps up to 400 W, depending on ventilation conditions, dimmable 230 V LED lamps and dimmable energy saving lamps (ESL) are also dependent on the lamp electronics.

Zero passage switching with soft start and soft OFF to protect lamps.

Universal control voltage input 8 to 230 V UC, electrically isolated from the 230 V supply voltage and switching voltage.

Short-time control commands switch on/off, permanent control varies the brightness to the maximum level.

A interruption of control changes the direction of dimming. The brightness level is stored after switching off in case the **function memory** is set. If the **function on max** is set, it always switches on at the maximum brightness level.

In case of a power failure the switching position and the brightness level are stored.

If applicable the dimmer will be switched on at the stored brightness level after the supply voltage is recovered.

Automatic electronic overload protection and over-temperature switch-off.

The minimum brightness level (completely dimmed down) can be adjusted with **the upper rotary switch** %⚙️, e.g. for dimmable energy saving lamps.

You can dim all lamp types in automatic mode.

Use the lower function rotary switch to select between five automatic mode functions: memory, memory+soft on, on max, on max+soft on and ESV+soft on.

+ESL is a convenience setting for energy saving lamps which must be switched on at high voltage for design reasons so that they can also be switched back on cold in dimmed state.

-ESL is a convenience setting for energy saving lamps which cannot be switched back on in dimmed state for design reasons. This is why memory is switched off in this position.

No inductive (wound) transformers may be used in +ESL and -ESL settings. In addition the maximum number of dimmable energy saving lamps may be lower than in automatic mode for design reasons.

Setting of function ESV same as 'memory+soft on' with setting of a release delay up to 90 minutes with the rotary switch %⚙️ if the manual off command is not given. Before time-out switch-off early warning function by dimming down within 1 minute.

Switching operation for children's rooms: If the light is switched on by holding down the pushbutton, it starts at the lowest brightness level after approx. 1 second and dims up slowly as long as the pushbutton is held down without modifying the last stored brightness level.

Snooze function: With a double impulse the lighting is dimmed down from the current dimming position to the minimum brightness level and switched off. The current dimming position as well as the adjustable minimum brightness level determine the dimming time (max. = 60 minutes) which can be reduced as required. It can be switched off at any time by short-time control commands during the lighting is dimmed down. Holding down the pushbutton during the dimming down process dims up and stops the snooze function.

Mixing of L loads (inductive loads, e.g. wound transformers) and C loads (capacitive loads, e.g. electronic transformers) is not permitted. R loads (ohmic loads, e.g. 230 V incandescent lamps and halogen lamps) may be added anytime.

Technical data page 9-20.

EUD61M-UC	Multifunction universal dimmer switch, Power MOSFET up to 400 W	Art. No. 61100903	61,10 €/pc.
------------------	---	--------------------------	--------------------

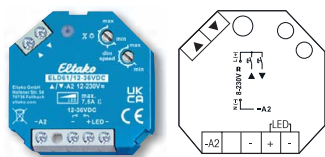

Function rotary switches

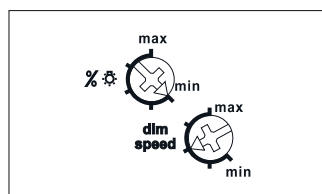

Standard setting ex works.

Typical connection

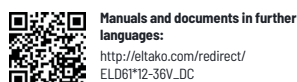
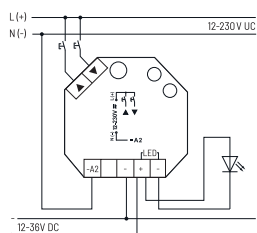

Manuals and documents in further languages:
http://eltako.com/redirect/ELD61*12-36V_DC

Technical data page 9-20.

ELD61/12-36V DC



Power MOSFET for LED lamps 12-36 V DC up to 4 A, pulse width modulation PWM. Stand-by loss 0.1 Watt only. With adjustable minimum brightness and dimming speed. With switching operation for children's rooms and snooze function.

For installation. 45 mm long, 45 mm wide, 18 mm deep.

Dimmer switch for R- and LED loads up to 4 A depending on ventilation conditions.

Zero passage switching with soft start and soft OFF to protect lamps.

Supply voltage input 12 to 36 V DC, depending on the connected LED illumination.

A pulse resistant switching power supply unit is necessary.

Universal control voltage 8..230 V UC, electrically isolated from the supply voltage.

Either direction pushbuttons can be connected to ▲ ▼ or these terminals will be bridged and a pushbutton will be connected as an universal pushbutton.

With universal pushbutton: short commands switch on/off, permanent control changes the brightness to the maximum. An interruption of the control changes the dimming direction.

With direction pushbutton: switching and dimming on with ▲, turning and dimming off with ▼. A dual pulse with ▲ effects dimming on up to the maximum brightness with the set dimming speed (dimspeed). The set brightness level will be stored when turning off (Memory).

In case of power failure the switching position and the brightness level will be stored and will be switched on when supply voltage recurs.

Automatic electronic overload protection and overtemperature switch off.

The LED indicates an activation by a short flickering.

With the top rotary switch % the minimum brightness level (completely dimmed down) can be adjusted.

With the lower dim speed rotary switch, the dimming speed can be set. At the same time, soft-on and soft-off is changed.

With switching operation for children's rooms (universal or direction pushbutton ▲):

if the light is switched on by holding down the pushbutton it starts at the lowest brightness level after approx. 1 second and dims up slowly as long as the pushbutton is pressed without modifying the latest stored brightness level.

Snooze function (universal or direction pushbutton ▼): with a double impulse the lighting is dimmed down from the current dimming position to the minimum brightness level and switched off. The current dimming position as well as the adjustable minimum brightness level determine the dimming time (max. = 60 minutes) which can be reduced as required. It can be switched off at any time by short-time control commands during the lighting is dimmed down. Holding down the pushbutton during the dimming down process dims up and stops the snooze function.

ELD61/12-36V DC	LED dimmer switch, Power MOSFET up to 4 A	Art. No. 61100865	62,50 €/pc.
------------------------	---	--------------------------	--------------------

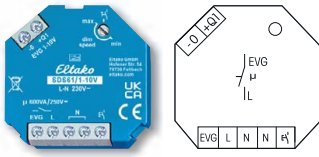

SDS61/1-10V



1 NO contact not potential free 600 VA and 1-10 V control output 40 mA. Only 0.5 watt standby loss. With adjustable dimming speed. With switching operation for children's rooms and snooze function. With pushbutton or switch activation.

Function rotary switch

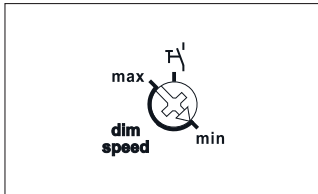

Standard setting ex works.

Typical connection

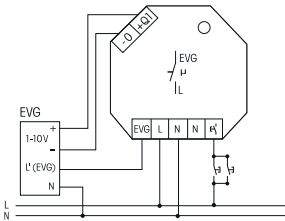

Manuals and documents in further languages:
http://eltako.com/redirect/SDS61*1-10V

Technical data page 9-20.

Built-in device for installation. 45 mm long, 45 mm wide, 33 mm deep.

Zero passage switching with soft ON and soft OFF to protect lamps.

Also adapted for LED driver with 1-10 V passive interface, without voltage source up to 0.6 mA, above this value an additional voltage source is necessary.

Switching voltage and control voltage 230 V.

State-of-the-art hybrid technology combines advantages of nonwearing electronic control with high capacity of special relays.

The load is switched on and off by a bistable relay at output EVG (electronic ballast units). Switching capacity for fluorescent lamps or LV halogen lamps with electronic ballast units 600 VA.

By using a bistable relay coil power loss and heating is avoided even in the on mode.

After installation, wait for short automatic synchronisation before the switched consumer is connected to the mains.

Short-time control commands switch on/off, permanent control varies the brightness up to the maximum level. An interruption of control changes the direction of dimming.

The brightness level is stored after switching off.

In case of a power failure the switching position and the brightness level are stored.

If applicable the dimmer will be switched on at the stored brightness level after the supply voltage is recovered.

The dimming speed is adjustable **using the dimming speed rotary switch (only for pushbutton activation).**

If light switches cannot be replaced by light pushbuttons, the rotary switch can be set to the switch symbol at the right stop:

When the closed switch is briefly opened, the light is dimmed until the switch is briefly opened again. The dimming direction is changed automatically at each of the two vertices. In addition the direction can be changed by opening the switch briefly twice.

Switching operation for children's rooms (only for pushbutton activation): If the light is switched on by

holding down the pushbutton, it starts at the lowest brightness level after approx. 1 second and dims up slowly as long as the pushbutton is held down without modifying the last stored brightness level.

Snooze function (only for pushbutton activation): With a double impulse the lighting is dimmed down from the current dimming position to the minimum brightness level and switched off. The current dimming position as well as the adjustable minimum brightness level determine the dimming time (max. = 60 minutes) which can be reduced as required. It can be switched off at any time by short-time control commands during the lighting is dimmed down. Holding down the pushbutton during the dimming down process dims up and stops the snooze function.

SDS61/1-10V	1-10 V control dimmer switch for electronic ballast units, 1 NO contact 600 VA	Art. No. 61100800	65,50 €/pc.
--------------------	--	--------------------------	--------------------

TECHNICAL DATA UNIVERSAL DIMMER SWITCHES, CAPACITY ENHANCERS AND 1-10 V CONTROLLERS

Type	ELD61 ^{a)}	EUD12NPN ¹⁾ EUD12D ¹⁾ EUD12DK ¹⁾ LUD12 ¹⁾ MFZ12PMD ¹⁾	EUD61NPN ¹⁾ EUD61M ¹⁾ EUD61NP ¹⁾ EUD61NPL ¹⁾	EUD12F ¹⁾	SDS12 SUD12	SDS61	MOD12D
Spacing of control connections/load	6 mm	6 mm	6 mm EUD61NP: 3 mm	6 mm	6 mm	3 mm	6 mm
Incandescent and halogen lamps 230 V (R)	-	up to 400 W EUD12DK: up to 800 W	up to 400 W EUD61NPL: 200 W	up to 300 W	-	-	-
Inductive transformers (L) ²⁾³⁾	-	up to 400 W EUD12DK: up to 800 W	up to 400 W (not EUD61NPL)	up to 300 W	-	-	-
Motor (L)	-	-	-	-	-	-	up to 300 W ⁷⁾
Capacitive transformers (C) ³⁾⁸⁾	-	up to 400 W EUD12DK: up to 800 W	up to 400 W EUD61NPL: 200 W	up to 300 W	-	-	-
Dimmable 230 V LED lamps ⁵⁾⁶⁾⁹⁾	-	Trailing edge up to 400 W Leading edge up to 100 W EUD12DK: Trailing edge up to 800 W Leading edge up to 200 W	Trailing edge up to 400 W, NPL: 200 W Leading edge up to 100 W, NPL: 40 W (not EUD61NP)	up to 300 W	-	-	-
Dimmable LED lamps 12-36 V DC	4 A	-	-	-	-	-	-
Dimmable energy saving lamps ESL ⁵⁾⁶⁾⁹⁾	-	up to 400 W EUD12DK: up to 800 W	up to 400 W EUD61NPL: 200 W (not EUD61NP)	up to 300 W	-	-	-
1-10 V EVG*	-	-	-	-	40 mA 600 VA	40 mA 600 VA	-
Maximum conductor cross-section (3-fold terminal)	4 mm ²	6 mm ² (4 mm ²)	4 mm ²	6 mm ² (4 mm ²)	6 mm ² (4 mm ²)	4 mm ²	6 mm ² (4 mm ²)
Two conductors of same crosssection (3-fold terminal)	1.5 mm ²	2.5 mm ² (1.5 mm ²)	1.5 mm ²	2.5 mm ² (1.5 mm ²)	2.5 mm ² (1.5 mm ²)	1.5 mm ²	2.5 mm ² (1.5 mm ²)
Screw head	slotted/cross-head	slotted/crosshead, pozidriv	slotted/crosshead	slotted/cross-head, pozidriv	slotted/cross-head, pozidriv	slotted/cross-head	slotted/cross-head, pozidriv
Type of enclosure/terminals	IP30/IP20	IP50/IP20	IP30/IP20	IP50/IP20	IP50/IP20	IP30/IP20	IP50/IP20
Time on	100%	100%	100%	100%	100%	100%	100%
Max./min. temperature at mounting location ⁴⁾	+50°C/-20°C	+50°C/-20°C	+50°C/-20°C	+50°C/-20°C	+50°C/-20°C	+50°C/-20°C	+50°C/-20°C
Standby loss (active power)	0.1 W	0, 2 W LUD12: 0.1 W 0.2 W EUD12D and MFZ12PMD: 0.3 W	0.2 W EUD61M: 0.1 W EUD61NPL, EUD61NP: 0.5 W	0.5 W	0.5 W	0.5 W	0.3 W
Control voltage	12..230 V UC	12..230 V UC	8..230 V UC EUD61NPN-230V and EUD61NP: 230 V	internal DC voltage	8..230 V UC	230 V	12..230 V UC
Control current 230 V-control input (<5 s)	-	-	EUD61NP: 0.7 mA EUD61NPN-230 V: 4(100) mA	-	-	0.5 mA	-
Control current universal control voltage all control voltages (<5 s)	-	10(100) mA	-	-	-	-	2/3/8/5 (100) mA
8/12/24/230 V (<5 s)	2/3/7/4(100) mA	-	2/3/7/4(100) mA	-	3/5/10/4(100) mA	-	-
Control current central 8/12/24/230 V (<5 s)	-	3/5/10/4(100) mA	-	-	3/5/10/4(100) mA	-	2/3/8/5 (100) mA
Max. parallel capacitance (approx. length) of single control lead at 230 V AC	0.3 µF (1000 m)	0.9 µF (3000 m)	0.9 µF (3000 m) EUD61NP: 0.3 µF (1000 m)	-	0.3 µF (1000 m)	0.06 µF (200 m)	0.9 µF (3000 m)
Max. parallel capacitance (approx. length) of central control lead at 230 V AC	-	0.9 µF (3000 m)	-	-	0.3 µF (1000 m)	-	0.9 µF (3000 m)

* EVG = electronic ballast units; KVG = conventional ballast units ^{a)} Secondary cable length with a maximum of 2 m. ¹⁾ At a load of more than 200 W (EUD12DK: 400 W, EUD12F: 100 W) a ventilation clearance of 1/2 module to adjacent devices must be maintained. The switching capacity of the EUD61 and DTD depends also on the ventilation conditions. ²⁾ Per dimmer or capacity enhancer it is only allowed to use max. 2 inductive (wound) transformers of the same type, **furthermore no-load operation on the secondary part is not permitted. The dimmer might be destroyed.** Therefore do not permit load breaking on the secondary part. Operation in parallel of inductive (wound) and capacitive (electronic) transformers is not permitted! ³⁾ **When calculating the load a loss of 20% for inductive (wound) transformers and a loss of 5% for capacitive (electronic) transformers must be considered in addition to the lamp load.** ⁴⁾ Affects the max. switching capacity. ⁵⁾ In the settings LED and ESL no wound (inductive) transformer must be dimmed. ⁶⁾ Increase of capacity for dimmable 230 V LED lamps and dimmable energy saving lamps ESL see page 9-8. ⁷⁾ Only 1 fan motor may be connected. ⁸⁾ For LED and 12 V halogen lamps. ⁹⁾ Usually applies for dimmable 230 V LED lamps and dimmable energy saving lamps. Different lamp electronics may result in restricted dimming areas, on/off problems and a limited maximum number of lamps (up to 10 units), especially if the connected load is very low (e.g. with 5 W LEDs). The comfort positions of the dimmer switches optimize the dimming range, which, however, only gives a maximum power up to 100 W. No inductive (wound) transformers may be dimmed in these comfort positions.

To comply with DIN VDE 0100-443 and DIN VDE 0100-534, a Type 2 or Type 3 surge protection device (SPD) must be installed.

**WSZ15D
DSZ15DZ
WSZ110CEE**



**INTELLIGENTLY MEASURE AND
VISUALIZE POWER.**

10

Three-phase and single-phase energy meters

	Selection table three-phase meters and single-phase energy meters	10 - 2
	Three-phase meter DSZ15D-3x80A MID and three-phase meter DSZ15DE-3x80A , without MID approval	10 - 3
NEW	Bidirectional three-phase meter DSZ15DZ-3x80A MID and multifunction current relay for bidirectional three-phase meter MFSR12DX-230V	10 - 4
NEW	Bidirectional three-phase meter DSZ15DZE-3x80A , without MID approval	10 - 5
	CT operated three-phase energy meter DSZ15WD-3x5A MID	10 - 6
	M-bus three-phase energy meter DSZ15DM-3x80A MID	10 - 7
	M-bus CT operated three-phase energy meter DSZ15WDM-3x5A MID	10 - 8
NEW	Modbus bidirectional three-phase energy meter DSZ15DZMOD-3x80A MID	10 - 9
	RS485 bus wireless three-phase energy meter DSZ14DRS-3x80A MID	10 - 10
	RS485 bus bidirectional three-phase meter DSZ14DRSZ-3x80A MID	10 - 11
	RS485 bus three-phase energy meter with settable CT ratio DSZ14WDRS-3x5A MID	10 - 12
	Mobile three-phase energy meter DSZ180CEE-16A MID and mobile three-phase energy meter DSZ180CEE-32A MID	10 - 13
NEW	RS485 bus single phase energy meter WSZ14DRS-32A MID and RS485 bus wireless single-phase energy meter FWZ14-65A	10 - 14
	RS485 bus meter collector F3Z14D	10 - 15
	RS485 bus energy meter data gateway FSDG14	10 - 16
NEW	Multifunction current relay for bidirectional three-phase meters MFSR12DX-230V	10 - 17
	Single-phase energy meter WSZ15D-32A MID and WSZ15DE-32A , without MID approval	10 - 18
	Single-phase energy meter WSZ15D-65A MID	10 - 19
	Single-phase energy meter WZR12-32A with reset, without MID approval	10 - 20
	Mobile single-phase energy meter WSZ110DSS-16A MID and mobile single-phase energy meter WSZ110DSS-16A+PRCD MID	10 - 21
	Mobile single-phase energy meter WSZ110CEE-16A MID and mobile single-phase energy meter WSZ110CEE-16A+PRCD MID	10 - 22
	Wireless energy meter transmitter module FSS12-12V DC	10 - 23
	Single-phase energy meter with energy consumption indicator EVA12-32A	10 - 24
	Wireless single-phase energy meter FWZ12-65A and wireless outdoor socket energy meter FASWZ-16A	10 - 25
	Wireless actuator impulse switch with integr. relay function with current measurement FVA-230V-10A	10 - 26
	Technical data single-phase energy meter, three-phase energy meters and energy consumption indicator	10 - 27
	Measuring Instruments Directive MID	10 - 28
	Installation instructions for electricians	10 - 29

The Eltako wireless system works with the reliable and worldwide standardized EnOcean wireless technology in 868 MHz. It transmits ultra short and interference-proof signals with a range of up to 100 meters in halls. Eltako wireless pushbuttons reduce the electrosmog load since they emit high-frequency waves that are 100 times weaker than conventional light switches. There is also a significant reduction in low-frequency alternating fields since fewer power cables need to be installed in the building.

SELECTION TABLE THREE-PHASE AND SINGLE-PHASE ENERGY METERS

THE SMART COUNTING CHAMPIONS

Depending on the customer's installation, only a conventional meter panel is required for billing with the electricity supply operator. On the other hand, dwellings and businesses can be billed using small three-phase meters installed in power distribution panels. See the installation instructions for electricians on page 10-29.

It is then the task of the building management service to read the intermediate meter. This either takes place at the same time as heating consumption is read or centrally, e.g. when the meter interface is evaluated. All Eltako energy meters for rail mounting are therefore fitted as standard with an SO interface.

Page	10-3	10-3	10-4	10-5	10-6	10-7	10-8	10-9	10-10	10-11	10-12	10-13	10-13	10-14	10-18	10-18	10-19	10-20	10-21	10-22	
	DSZ15D-3x80A	DSZ15DE-3x80A	DSZ15DZ-3x80A	DSZ15DZE-3x80A	DSZ15WD-3x5A	DSZ15DM-3x80A	DSZ15WDM-3x5A	DSZ15DZMOD-3x80A	DSZ14DRS-3x80A	DSZ14DRSZ-3x80A	DSZ14WDRS-3x5A	DSZ180CEE-16A	DSZ180CEE-32A	WSZ14DRS-32A	WSZ15D-32A	WSZ15DE-32A	WSZ15D-65A	WZR12-32A	WSZ110DSS-16A	WSZ110CEE-16A	
Modular device for mounting on DIN rail EN 60715 TH35, number of modules 18 mm each	4	4	4	4	4	4	4	4	4	4	4			1	1	1	1	1			
mobil																					
Single-phase energy meter																					
Three-phase energy meter	■	■			■	■	■	■	■	■		■	■	■							
Bidirectional three-phase meter			■	■						■											
With MID approval	■		■		■	■	■	■	■	■	■	■	■	■	■			■		■	■
Reference current I_{ref} (Limiting current I_{max}) A	10(80)	10(80)	10(80)	10(80)	5(6) ¹⁾	10(80)	5(6) ¹⁾	5(6) ¹⁾	10(80)	10(80)	5(6) ¹⁾	10(80)	10(80)	5(32)	5(32)	5(32)	10(65)	5(32)	5(32)	5(32)	5(32)
	lb=16	lb=32																			
Display LC display digits	5+2 ²⁾ 6+1	5+2 ²⁾ 6+1	5+2 ²⁾ 6+1	5+2 ²⁾ 6+1	6+1	5+2 ²⁾ 6+1	6+1	5+2 ²⁾ 6+1	5+2 ²⁾ 6+1	5+2 ²⁾ 6+1	6+1	5+2 ²⁾ 6+1	5+2 ²⁾ 6+1	5+2 ²⁾ 6+1	5+2 ²⁾ 6+1	5+2 ²⁾ 6+1	5+2 ²⁾ 6+1	2/4	5+2 ²⁾ 6+1	5+2 ²⁾ 6+1	
Accuracy class MID, inaccuracy ±1%	B	B	B	B	B	B	B	B	B	B	B	B	B	B	B	B	B	B	B	B	B
With return stop	■	■			■	■	■	■	■		■	■	■	■	■	■	■	■	■	■	■
Display instantaneous values	■	■	■	■	■	■	■	■	■	■	■			■	■	■	■	■	■	■	■
Indication of disconnection	■	■	■	■	■	■	■	■	■	■	■			■	■	■	■	■	■	■	■
Low standby loss	■	■	■	■	■	■	■	■	■	■	■	■	■	■	■	■	■	■	■	■	■
SO interface potential	■	■	■	■	■										■	■	■				
M-bus interface						■	■														
Modbus interface								■													
Interface for Eltako RS485 bus									■	■	■			■							

¹⁾ CT operated energy meter

²⁾ Switches over automatically from 5+2 to 6+1.

MID meters require no subsequent calibration with calibration mark. Instead, they are the equivalent of calibrated meters as a result of MID testing and an EU Declaration of Conformity from the manufacturer.

**THREE-PHASE ENERGY METER DSZ15D-3X80A MID AND
THREE-PHASE ENERGY METER DSZ15DE-3X80A, WITHOUT MID APPROVAL**



Typical connection

4-wire-connection 3x230/400 V

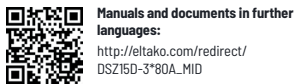
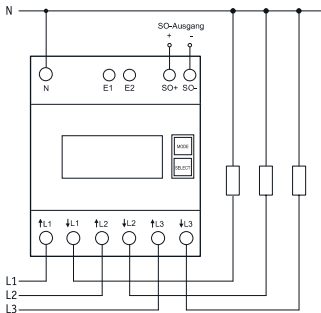

Manuals and documents in further languages:
http://eltako.com/redirect/DSZ15D-3*80A_MID

Technical data page 10-27.



Typical connection

4-wire-connection 3x230/400 V

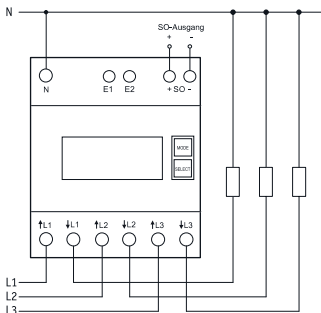

Manuals and documents in further languages:
http://eltako.com/redirect/DSZ15DE-3*80A

Technical data page 10-25.

Recommended retail prices excluding VAT.

DSZ15D-3X80A MID

MID

Maximum current 3x80 A. Standby loss 0.5 watt per path only.

Modular device for DIN-EN 60715 TH35 rail mounting.

4 modules = 70 mm wide and 58 mm deep.

Accuracy class B (1%). With SO interface.

It measures active energy by means of the current between input and output. The internal power consumption of 0.5 watt active power per path is neither metered nor indicated.

1, 2 or 3 phase conductors with max. currents up to 80 A can be connected.

The inrush current is 40 mA.

The N terminal must always be connected.

The 7 segment LC display is also legible twice within a period of 2 weeks without power supply.

Power consumption is shown by a bar flashing at a rate of 100 times per kWh.

Designed as standard for using as double-tariff meter: Switch over to a second tariff by applying 230 V to terminals E1/E2.

On the right next to the display are the keys MODE and SELECT. Press them to scroll through the menu according to the operation manual. First the **background lighting** switches on. The display then shows the total active energy per tariff, the active energy per resettable memory RS1 or RS2, and the instantaneous values of consumption, voltage and current per phase.

Error message (false)

When the phase conductor is missing or the current direction is wrong 'false' and the corresponding phase conductor are indicated on the display.

DSZ15D-3x80A MID	Three-phase energy meter, MID approval	Art. No. 28380015	157,60 €/pc.
-------------------------	--	--------------------------	---------------------

10-3

DSZ15DE-3X80A

Maximum current 3x80 A. Standby loss 0.5 watt per path only.

Modular device for DIN-EN 60715 TH35 rail mounting.

4 modules = 70 mm wide and 58 mm deep.

Accuracy class B (1%). With SO interface.

It measures active energy by means of the current between input and output. The internal power consumption of 0.5 watt active power per path is neither metered nor indicated. Like all meters without declaration of conformity (e.g. MID), this meter is not permitted for billing.

1, 2 or 3 phase conductors with max. currents up to 80 A can be connected.

The inrush current is 40 mA.

The N terminal must always be connected.

The 7 segment LC display is also legible twice within a period of 2 weeks without power supply.

Power consumption is shown by a bar flashing at a rate of 100 times per kWh.

Designed as standard for using as double-tariff meter: Switch over to a second tariff by applying 230 V to terminals E1/E2.

On the right next to the display are the keys MODE and SELECT. Press them to scroll through the menu according to the operation manual. First the **background lighting** switches on. The display then shows the total active energy per tariff, the active energy per resettable memory RS1 or RS2, and the instantaneous values of consumption, voltage and current per phase.

Error message (false)

When the phase conductor is missing or the current direction is wrong 'false' and the corresponding phase conductor are indicated on the display.

DSZ15DE-3x80A	Three-phase energy meter, without MID approval	Art. No. 28380615	116,00 €/pc.
----------------------	--	--------------------------	---------------------

BIDIRECTIONAL THREE-PHASE METER DSZ15DZ-3x80A MID AND MULTIFUNCTION CURRENT RELAY FOR BIDIRECTIONAL THREE-PHASE METERS MFSR12DX-230V



Typical connection

4-wire-connection 3x230/400 V

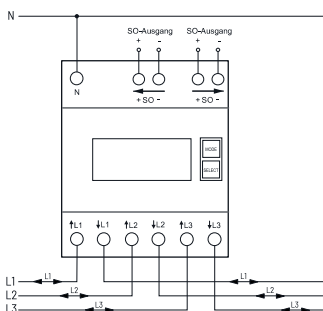

Manuals and documents in further languages:
http://eltako.com/redirect/DSZ15DZ-3x80A_MID

Technical data page 10-27.



Manuals and documents in further languages:
<http://eltako.com/redirect/MFSR12DX-230V>

Further informations
on page 10-17.

DSZ15DZ-3x80A MID



Bidirectional three-phase meter. Maximum current 3x80 A. Standby loss 0.5 watt per path only.

Modular device for DIN-EN 60715 TH35 rail mounting.

4 modules = 70 mm wide and 58 mm deep.

Accuracy class B (1%). With S0 interface as standard.

It measures active energy by means of the current between input and output. The internal power consumption of 0.5 watt active power per path is neither metered nor indicated.

The active energy is added depending on the sign. Positive power in the meter means energy consumption, negative power means energy delivery. The energy measurement is balanced.

If the energy consumption (P positive) is greater than the energy supply (P negative), the meter reading T → is increased. If the energy supply is greater than the energy consumption, the meter reading T ← is increased. Energy consumption is shown with a right arrow → and energy supply is shown with a left arrow ← above the active bar in the display.

1, 2 or 3 phase conductors with max. currents up to 80 A can be connected.

The inrush current is 40 mA.

The N terminal must always be connected.

Energy consumption and energy supply values are stored in non-volatile memory and are displayed again immediately after a power failure.

The 7 segment LC display is also legible twice within a period of 2 weeks without power supply.

Power consumption is shown by a bar flashing at a rate of 100 times per kWh.

On the right next to the display are the keys MODE and SELECT. Press them to scroll through the menu.

First the **background lighting** switches on. Then the total active energy per consumption and delivery, the active energy of the resettable memory consumption and delivery as well as the instantaneous power, voltage and current values for each phase conductor can be displayed.

Error message

If a phase connection is missing, the corresponding phase is shown on the display.

DSZ15DZ-3x80A MID	Bidirectional three-phase meter, MID approval	Art. No. 28480315	210,90 €/pc.
--------------------------	---	--------------------------	---------------------

MFSR12DX-230V



Multifunction current relay for Bidirectional three-phase meters with two S0 outputs or IR interface according to IEC 62056-21. 1 NO contact potential free 16 A/250 V AC, with DX technology. Standby loss 0.6 watt only.

Modular device for DIN-EN 60715 TH35 rail mounting.

3 modules = 54 mm wide, 58 mm deep.

This current relay either evaluates the data of a balancing bidirectional three-phase meter, e.g. DSZ15DZ-3x80A with two S0 interfaces, or that of an electronic household meter (eHZ-EDL) with IR interface according to IEC 62056-21 and SML protocol version 1.

The data for the power consumed (→) and the power supplied (←) are recorded, evaluated and a relay contact is switched on or off according to the settings.

With the patented Eltako Duplex technology (DX) the normally potential-free contact can still switch in zero passage when switching 230 V AC 50 Hz and therefore drastically reduce wear. Simply connect the neutral conductor to the terminal (N) for this. This results in an standby consumption of only 0.1 watt. Supply voltage 230 V.

MFSR12DX-230V	Multifunction current relay for bidirectional three-phase meters MFSR12DX-230V	Art. No. 22100530	104,10 €/pc.
----------------------	--	--------------------------	---------------------



Typical connection

4-wire-connection 3x230/400 V

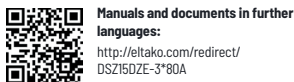
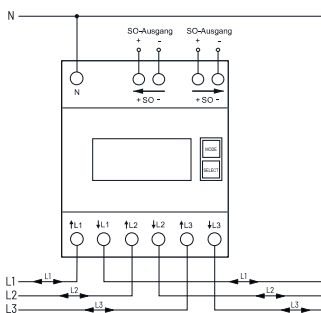

Manuals and documents in further languages:
http://eltako.com/redirect/DSZ15DZE-3*80A

Technical data page 10-27.

DSZ15DZE-3x80A

NEW

Bidirectional three-phase meter. Maximum current 3x80 A. Standby loss 0.5 watt per path only.

Modular device for DIN-EN 60715 TH35 rail mounting.

4 modules = 70 mm wide and 58 mm deep.

Accuracy class B (1%). With SO interface as standard.

It measures active energy by means of the current between input and output. The internal power consumption of 0.5 watt active power per path is neither metered nor indicated.

The active energy is added depending on the sign. Positive power in the meter means energy consumption, negative power means energy delivery. The energy measurement is balanced.

If the energy consumption (P positive) is greater than the energy supply (P negative), the meter reading T → is increased. If the energy supply is greater than the energy consumption, the meter reading T ← is increased. Energy consumption is shown with a right arrow → and energy supply is shown with a left arrow ← above the active bar in the display.

1, 2 or 3 phase conductors with max. currents up to 80 A can be connected.

The inrush current is 40 mA.

The N terminal must always be connected.

Energy consumption and energy supply values are stored in non-volatile memory and are displayed again immediately after a power failure.

The 7 segment LC display is also legible twice within a period of 2 weeks without power supply.

Power consumption is shown by a bar flashing at a rate of 100 times per kWh.

On the right next to the display are the keys MODE and SELECT. Press them to scroll through the menu.

First the **background lighting** switches on. Then the total active energy per consumption and delivery, the active energy of the resettable memory consumption and delivery as well as the instantaneous power, voltage and current values for each phase conductor can be displayed.

Error message

If a phase connection is missing, the corresponding phase is shown on the display.

DSZ15DZE-3x80A	Bidirectional three-phase meter, without MID	Art. No. 28380215	180,00 €/pc.
-----------------------	--	--------------------------	---------------------

10-5



Typical connection

4-wire-connection 3x230/400 V

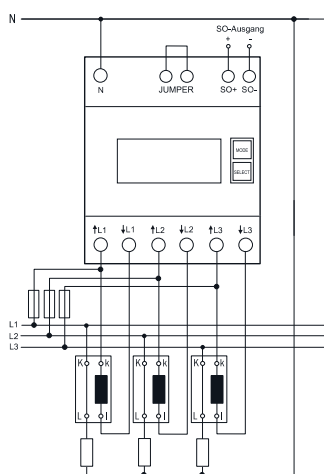

Manuals and documents in further languages:
http://eltako.com/redirect/DSZ15WD-3*5A_MID

Technical data page 10-27.

DSZ15WD-3X5A MID

MID

CT operated three-phase energy meter with settable CT ratio and MID. Maximum current 3x5 A. Standby loss 0.5 watt per path only.

Modular device for DIN-EN 60715 TH35 rail mounting.
 4 modules = 70 mm wide and 58 mm deep.
 Accuracy class B (1%). With SO interface.
 This three-phase energy meter measures active energy by means of the current between input and output. The internal power consumption of 0.5 watt active power per path is neither metered nor indicated.
1, 2 or 3 phase conductors with max. currents up to 5 A can be connected.

The inrush current is 10 mA.
 The N terminal must always be connected.

The 7 segment LC display is also legible twice within a period of 2 weeks without power supply.

Power consumption is shown by a bar flashing at a rate of 10 times per kWh.
 On the right next to the display are the keys MODE and SELECT. Press them to scroll through the menu according to the operation manual. First the **background lighting** switches on. The display then shows the total active energy, the active energy per resettable memory, and the instantaneous values of consumption, voltage and current per phase.

The CT ratio can also be set. It is set to 5:5 at the factory and blocked with a bridge over the terminals which are marked with 'JUMPER'. To adjust the CT ratio to the installed transformer remove the bridge and reset the energy meter according to the operation manual. Then block it again with the bridge. Adjustable current transformer ratios: 5:5, 50:5, 100:5, 150:5, 200:5, 250:5, 300:5, 400:5, 500:5, 600:5, 750:5, 1000:5, 1250:5 and 1500:5.

Error message (false)

When the phase conductor is missing or the current direction is wrong 'false' and the corresponding phase conductor are indicated on the display.

Important! Before working on the current transformers disconnect the voltage paths of the energy meters.

DSZ15WD-3x5A MID	CT operated three-phase energy meter, MID approval	Art. No. 28305015	204,10 €/pc.
-------------------------	--	--------------------------	---------------------

10-6



Typical connection

4-wire-connection 3x230/400 V

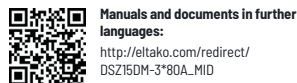
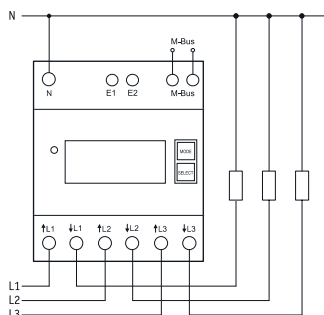

Manuals and documents in further languages:
http://eltako.com/redirect/DSZ15DM-3*80A_MID

DSZ15DM-3X80A MID

MID

M-bus three-phase energy meter.

Maximum current 3x80 A. Standby loss 0.5 watt per path only.

Modular device for DIN-EN 60715 TH35 rail mounting.

4 modules = 70 mm wide and 58 mm deep.

Accuracy class B (1%). With M-bus interface.

It measures active energy by means of the current between input and output.

The internal power consumption of 0.5 watt active power per path is neither metered nor indicated.

1, 2 or 3 phase conductors with max. currents up to 80 A can be connected.

The inrush current is 40 mA.

The N terminal must always be connected.

The 7 segment LC display is also legible twice within a period of 2 weeks without power supply.

Power consumption is indicated by an LED flashing at a rate of 1000 times per kWh.

Designed as standard for using as double-tariff meter: Switch over to a second tariff by applying 230 V to terminals E1/E2.

On the right next to the display are the keys MODE and SELECT. Press them to scroll through the menu.

First the **background lighting** switches on. The display then shows the total active energy per tariff, the active energy of the resettable memory RS1 or RS2 as well as the instantaneous values of consumption, voltage and current per phase

Error message (false)

When the phase conductor is missing or the current direction is wrong 'false' and the corresponding phase conductor are indicated on the display.

M-bus data transfer

- On read-out all values are transferred in a telegram.

- The following telegrams are supported:

- Initialisation: SND_NKE Reply: ACK
- Read out meter: REQ_UD2 Reply: RSP_UD
- Change primary address: SND_UD Reply: ACK
- Reset RS1: SND_UD Reply: ACK
- Slave selection for the secondary address Reply: ACK

- The device does not reply to unknown requests

- The transfer rate is detected automatically

- The device has a voltage monitor. In case of voltage loss, all registers are saved in the EEPROM.

Changing the M-bus primary address:

To change the M-bus primary address, hold down SELECT for 3 s. In the menu that appears, press MODE to increment the address by 10. Press SELECT to increment by 1. When the required primary address is set, wait until the main menu reappears.

Secondary address

- It is possible to communicate with the energy meters according to the standard EN13757 using the secondary address.

- The use of wild cards is possible.

For details refer to the operating instructions at www.eltako.com.

Technical data page 10-25.

DSZ15DM-3x80A MID	M-bus three-phase energy meter, MID approval	Art. No. 28380512	243,70 €/pc.
--------------------------	---	--------------------------	---------------------



Typical connection

4-wire-connection 3x230/400 V

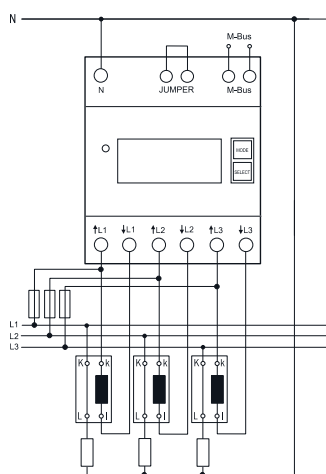

Manuals and documents in further languages:
http://eltako.com/redirect/DSZ15WDM-3*5A_MID

DSZ15WDM-3X5A MID

MID

M-bus CT operated three-phase energy meter with settable CT ratio and MID. Maximum current 3x5 A. Standby loss 0.5 watt per path only.

Modular device for DIN-EN 60715 TH35 rail mounting.
 4 modules = 70 mm wide and 58 mm deep.
 Accuracy class B (1%). With M-bus interface.
 This three-phase meter measures active energy by means of the currents flowing between inputs and outputs. The internal power consumption of 0.5 watt active power per path is neither metered nor indicated.
1, 2 or 3 converters with secondary currents of up to 5 A can be connected.

The inrush current is 10 mA.
 The N terminal must always be connected.
The 7 segment LC display is also legible twice within a period of 2 weeks without power supply.
 Power consumption is indicated by an LED flashing at a rate of 10 times per kWh.

On the right next to the display are the MODE and SELECT buttons to browse through the menu. First the **background lighting** switches on. Then the total active energy, the active energy of the resettable memory and the instantaneous values of power, voltage and current are displayed for each outer conductor.
The CT ratio can also be set. It is set to 5:5 at the factory and blocked with a bridge over the terminals which are marked with 'JUMPER'. To adjust the CT ratio to the installed transformer remove the bridge and reset the energy meter according to the operation manual. Then block it again with the bridge. Adjustable current transformer ratios: 5:5, 50:5, 100:5, 150:5, 200:5, 250:5, 300:5, 400:5, 500:5, 600:5, 750:5, 1000:5, 1250:5 and 1500:5.

Error message (false)

If there is no outer conductor of the current direction is incorrect, 'false' and the related outer conductor are indicated in the display.

M-bus data transfer

- On read-out all values are transferred in a telegram.
- The following telegrams are supported:
 - Initialisation: SND_NKE Reply: ACK
 - Read out meter: REQ_UD2 Reply: RSP_UD
 - Change primary address: SND_UD Reply: ACK
 - Reset RS1: SND_UD Reply: ACK
 - Slave selection for the secondary address Reply: ACK
- The device does not reply to unknown requests
- The transfer rate is detected automatically
- The device has a voltage monitor. In case of voltage loss, all registers are saved in the EEPROM.

Changing the M-bus primary address:

To change the M-bus primary address, hold down SELECT for 3 s. In the menu that appears, press MODE to increment the address by 10. Press SELECT to increment by 1. When the required primary address is set, wait until the main menu reappears.

Secondary address

- It is possible to communicate with the energy meters according to the standard EN13757 using the secondary address.
- The use of wild cards is possible.

For details refer to the operating instructions at www.eltako.com.

Important!

Before working on the current transformers disconnect the voltage paths of the energy meters.

Technical data page 10-25.

DSZ15WDM-3x5A MID	CT operated three-phase energy meter, MID approval	Art. No. 28305515	243,70 €/pc.
--------------------------	--	--------------------------	---------------------

10-8



DSZ15DZMOD-3x80A MID

NEW MID

Modbus bidirectional three-phase meter. Maximum current 3x80 A, standby loss only 0.8 watts at L1 and 0.5 W each at L2 and L3.

Typical connection

4-wire-connection 3x230/400 V

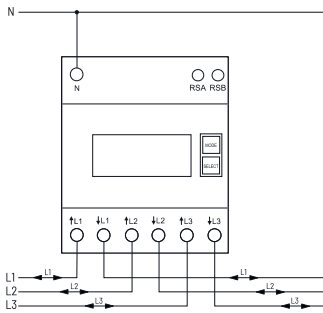

Manuals and documents in further languages:
http://eltako.com/redirect/DSZ15DZMOD-3*80A_MID

Modular installation device for mounting on mounting rail DIN-EN 60715 TH35 in installation cabinets with protection class IP51.

4 modules = 70 mm wide and 58 mm deep.

Accuracy class B (1%). With Modbus/ RTU (RS485) interface.

It measures active energy by means of the current between input and output. The internal power consumption of 0.8 resp. 0.5 watt active power per path is neither metered nor indicated.

The active energy is added depending on the sign. Positive power in the meter means energy consumption, negative power means energy delivery. The energy measurement is balanced. If the energy consumption (P positive) is greater than the energy supply (P negative), the meter reading T → is increased. If the energy supply is greater than the energy consumption, the meter reading T ← is increased. Energy consumption is shown with a right arrow → and energy supply is shown with a left arrow ← above the active bar in the display.

1, 2 or 3 phase conductors with max. currents up to 80 A can be connected.

The inrush current is 40 mA.

L1 and N connections must be available.

Connection via RS485 Modbus data logger: Data transfer Modbus/RTU (RS485) and address assignment according to the operating instructions.

Energy consumption and energy supply values are stored in non-volatile memory and are displayed again immediately after a power failure.

The 7 segment LC display is also legible twice within a period of 2 weeks without power supply.

The power consumption and the power supply are indicated by an LED next to the display that flashes 1000 times per kWh.

On the right next to the display are the keys MODE and SELECT. Press them to scroll through the menu.

First the **background lighting** switches on. Then the total active energy per consumption and delivery, the active energy of the resettable memory consumption and delivery as well as the instantaneous power, voltage and current values for each phase conductor can be displayed.

Error message

If a phase connection is missing, the corresponding phase is shown on the display.

Technical data page 10-27.

DSZ15DZMOD-3x80A MID	Modbus bidirectional three-phase meter, MID	Art. No. 28380516	243,70 €/pc.
-----------------------------	---	--------------------------	---------------------



Typical connection

4-wire-connection 3x230/400 V

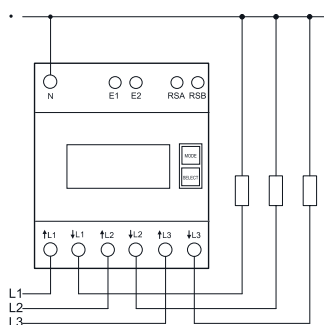

Further settings can be made using the PC Tool PCT14 (see page 1-5).



Manuals and documents in further languages:
http://eltako.com/redirect/DSZ14DRS-3*80A_MID

Housing for operating instructions GBA14 page 1-49.
 Technical data page 10-27.

DSZ14DRS-3X80A MID

MID

RS485 bus three-phase energy meter. Maximum current 3 x 80 A. Standby loss 0.8 W at L1 and only 0.5 W at L2 and L3 each.

Modular device for DIN-EN 60715 TH35 rail mounting in distribution cabinets with IP51 protection class. 4 modules = 70 mm wide and 58 mm deep. Accuracy class B (1%). With RS485 interface.

It measures active energy by means of the current between input and output. The internal power consumption of 0.8 W or 0.5 W active power per path is neither metered nor indicated.

1, 2 or 3 phase conductors with max. currents up to 80 A can be connected.

The inrush current is 40 mA.

The terminals 1L1 and N must always be connected.

Connection to the Eltako RS485 bus via a FBA14 by means of a 2-wire screened bus line (e.g. telephone line). The meter reading and the momentary capacity are transferred to the bus – e.g. for transfer to an external computer or a controller – and is also transferred to the wireless network via the FAM14. For this it is necessary that a device address is assigned from the wireless antenna module FAM14, according to the operating instructions.

The 7 segment LC display is also legible twice within a period of 2 weeks without power supply.

The power consumption is displayed with a LED flashing 1000 times per kWh next to the display.

Designed as standard for using as double-tariff meter: Switch over to a second tariff by applying 230 V to terminals E1/E2.

On the right next to the display are the keys MODE and SELECT. Press them to scroll through the menu according to the operation manual. First the **background lighting** switches on. The display then shows the total active energy per tariff, the active energy per resettable memory RS1 or RS2, and the instantaneous values of power, voltage, current as well as the Pch value can be displayed.

Error message (false)

When the phase conductor is missing or the current direction is wrong 'false' and the corresponding phase conductor are indicated on the display.

Meter special operating modes:

In the meter operating modes, the focus is on the adjustable transmission speed of electricity meter data for external building energy managers. Data can be accessed and forwarded via gateways connected to the FAM14 (FGW14, FGW14-USB, FGW14W(L)-IP). **Additional setting options are available on the FAM14 for meters from production week 33/23..**

DSZ14DRS-3x80A	RS485 bus three-phase energy meter with display, MID	Art. No. 28365715	200,50 €/pc.
-----------------------	--	--------------------------	---------------------



Typical connection

4-wire-connection 3x230/400 V

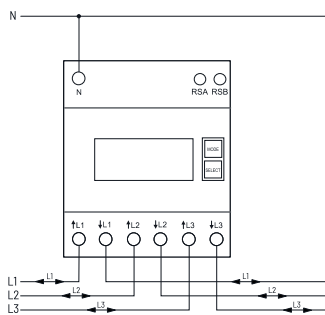

Further settings can be made using the PC Tool PCT14 (see page 1-5).



Manuals and documents in further languages:
http://eltako.com/redirect/DSZ14DRSZ-3*80A_MID

Housing for operating instructions GBA14 page 1-49.
 Technical data page 10-27.

DSZ14DRSZ-3x80A MID



RS485 bus bidirectional three-phase meter. Maximum current 3x80 A. Standby loss 0,8 W at L1 and only 0,5 W at L2 and L3 each.

Modular device for DIN-EN 60715 TH35 rail mounting in distribution cabinets with IP51 protection class. 4 modules = 70 mm wide and 58 mm deep. Accuracy class B (1%). With RS485 interface.

It measures active energy by means of the current between input and output. The internal power consumption of 0,8 W or 0,5 W active power per path is neither metered nor indicated.

The active energy is added depending on the sign. Positive power in the meter means energy consumption, negative power means energy delivery. The energy measurement is balanced.

If the energy consumption (P positive) is greater than the energy supply (P negative), the meter reading T → is increased. If the energy supply is greater than the energy consumption, the meter reading T ← is increased. Energy consumption is shown with a right arrow → and energy supply is shown with a left arrow ← above the active bar in the display.

1, 2 or 3 phase conductors with max. currents up to 80 A can be connected.

The inrush current is 40 mA.

The terminals L1 and N must always be connected.

Connection via a FBA14 to the Eltako RS485 bus with a 2-wire shielded bus cable (telephone cable).

The meter reading and the momentary power are transferred to the bus – e.g. for transfer to an external computer or a controller – and is also transferred to the wireless network via the FAM14. For this it is necessary that a device address is assigned from the wireless antenna module FAM14, according to the operating instructions.

Energy consumption and energy supply values are stored in non-volatile memory and are displayed again immediately after a power failure.

The 7 segment LC display is also legible twice within a period of 2 weeks without power supply.

Power consumption is indicated using a LED next to the display flashing 1000 times per kWh.

On the right next to the display are the keys MODE and SELECT. Press them to scroll through the menu.

First the **background lighting** switches on. Then the total active energy per consumption and delivery, the active energy of the resettable memory consumption and delivery and the instantaneous values of power, voltage, current as well as the Pch value can be displayed.

Error message

If a phase connection is missing, the corresponding phase is shown on the display.

Meter special operating modes:

In the meter operating modes, the focus is on the adjustable transmission speed of electricity meter data for external building energy managers. Data can be accessed and forwarded via gateways connected to the FAM14 (FGW14, FGW14-USB, FGW14W(L)-IP). **Additional setting options are available on the FAM14 for meters from production week 33/23..**

DSZ14DRSZ-3x80A	RS485 bus two-way three-phase meter with display, MID approval	Art. No. 28465715	232,20 €/pc.
------------------------	--	--------------------------	---------------------

RS485 BUS THREE-PHASE ENERGY METER WITH SETTABLE CT RATIO, DSZ14WDRS-3X5A MID



Typical connection

4-wire-connection 3x230/400 V

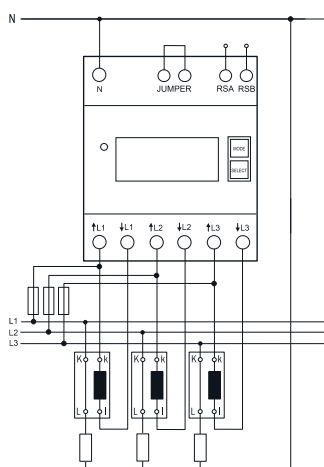

Further settings can be made using the PC Tool PCT14 (see page 1-5).



Manuals and documents in further languages:
http://eltako.com/redirect/DSZ14WDRS-3*5A_MID

Housing for operating instructions GBA14 page 1-49.

DSZ14WDRS-3X5A MID

MID

RS485 bus three-phase energy meter with settable CT ratio and MID. Maximum current 3x5 A. Standby loss 0.8 W at L1 and only 0.5 W at L2 and L3 each.

Modular device for DIN-EN 60715 TH35 rail mounting in distribution cabinets with IP51 protection class. 4 modules = 70 mm wide and 58 mm deep.

Accuracy class B (1%). With RS485 interface.

This three-phase energy meter measures active energy by means of the current between input and output. The internal power consumption of 0.8 W or 0.5 W active power per path is neither metered nor indicated.

1, 2 or 3 phase conductors with max. currents up to 5 A can be connected.

The inrush current is 10 mA.

The terminals 1L1 and N must always be connected.

Connection to the Eltako RS485 bus via a FBA14 by means of a 2-wire screened bus line (e.g. telephone line). The meter reading and the momentary capacity are transferred to the bus – e.g. for transfer to an external computer or a controller – and is also transferred to the wireless network via the FAM14. For this it is necessary that a device address is assigned from the wireless antenna module FAM14, according to the operating instructions.

The 7 segment LC display is also legible twice within a period of 2 weeks without power supply.

The power consumption is displayed with a LED flashing 10 times per kWh next to the display.

On the right next to the display are the keys MODE and SELECT. Press them to scroll through the menu.

First the **background lighting** switches on. The display then shows the total active energy, the active energy of the resettable memory and the instantaneous values of power, voltage, current as well as the Pch value can be displayed.

The CT ratio can also be set. It is set to 5:5 at the factory and blocked with a bridge over the terminals which are marked with 'JUMPER'. To adjust the CT ratio to the installed transformer remove the bridge and reset the energy meter according to the operation manual. Then block it again with the bridge. Adjustable current transformer ratios: 5:5, 50:5, 100:5, 150:5, 200:5, 250:5, 300:5, 400:5, 500:5, 600:5, 750:5, 1000:5, 1250:5 and 1500:5.

Error message (false)

When the phase conductor is missing or the current direction is wrong 'false' and the corresponding phase conductor are indicated on the display.

Important! Before working on the current transformers disconnect the voltage paths of the energy meters.

Meter special operating modes:

In the meter operating modes, the focus is on the adjustable transmission speed of electricity meter data for external building energy managers. Data can be accessed and forwarded via gateways connected to the FAM14 (FGW14, FGW14-USB, FGW14W(L)-IP). **Additional setting options are available on the FAM14 for meters from production week 33/23.**

DSZ14WDRS-3x5A	RS485 bus three-phase energy meter with settable CT ratio with display, MID approval	Art. No. 28305712	209,10 €/pc.
-----------------------	--	--------------------------	---------------------

MOBILE THREE-PHASE ENERGY METER DSZ180CEE-16A MID
MOBILE THREE-PHASE ENERGY METER DSZ180CEE-32A MID



Manuals and documents in further languages:
http://eltako.com/redirect/DSZ180CEE-16A_MID

Technical data page 10-27.

DSZ180CEE-16A MID

NEW **MID**

Mobile three-phase energy meter with CEE plug 16 A and CEE coupling 16 A. Suitable for indoor and outdoor use. Maximum current 16 A, standby loss 0.5 watt per path only.

Housing dimensions 180x86x82 mm, connection cable 1.5 m (including plug and coupling).

Accuracy class B (1%).

This mobile three-phase energy meter measures active energy by means of the current between input and output.

The internal power consumption of max. 0.5 watt active power per path is neither metered nor indicated. The inrush current is 40 mA.

The display can only be read when the power supply is on. However, the consumption is saved to a non-volatile memory and is displayed immediately after a power failure.

The digital display has 7 digits. Two decimal places are indicated up to 99999.99 kWh.

Above 100000.0 kWh there is only one decimal place.

Power consumption is shown by a LED flashing at a rate of 100 times per kWh.

DSZ180CEE-16A MID	Mobile three-phase energy meter, with MID	Art. No. 28016128	213,70 €/pc.
--------------------------	---	--------------------------	---------------------



Manuals and documents in further languages:
http://eltako.com/redirect/DSZ180CEE-32A_MID

Technical data page 10-27.

DSZ180CEE-32A MID

NEW **MID**

Mobile three-phase energy meter with CEE plug 32 A and CEE coupling 32 A. Suitable for indoor and outdoor use. Maximum current 32 A, standby loss 0.5 watt per path only.

Housing dimensions 180x86x82 mm, connection cable 1.5 m (including plug and coupling).

Accuracy class B (1%).

This mobile three-phase energy meter measures active energy by means of the current between input and output.

The internal power consumption of max. 0.5 watt active power per path is neither metered nor indicated. The inrush current is 40 mA.

The display can only be read when the power supply is on. However, the consumption is saved to a non-volatile memory and is displayed immediately after a power failure.

The digital display has 7 digits. Two decimal places are indicated up to 99999.99 kWh.

Above 100000.0 kWh there is only one decimal place.

Power consumption is shown by a LED flashing at a rate of 100 times per kWh.

DSZ180CEE-32A MID	Mobile three-phase energy meter, with MID	Art. No. 28032128	225,50 €/pc.
--------------------------	---	--------------------------	---------------------

**RS485 BUS SINGLE-PHASE ENERGY METER WSZ14DRS-32A MID WITH DISPLAY AND
RS485 BUS SINGLE-PHASE ENERGY METER TRANSMITTER MODULE FWZ14-65A**



Typical connection

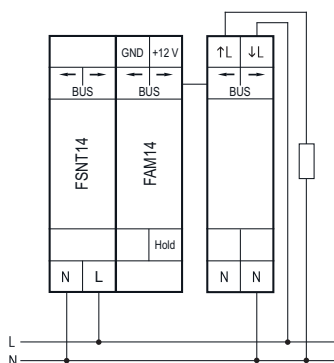

WSZ14DRS-32A MID



Maximum current 32 A. Standby loss 0.4 watt only.

Modular device for DIN-EN 60715 TH35 rail mounting. 1 module = 18 mm wide and 58 mm deep.

Connection to the Eltako RS485 bus. Bus wiring and power supply with jumpers.

The meter reading, the instantaneous power and the serial number are transferred to the bus - e.g. B. for transfer to an external computer, to a controller - and also sent to the radio network via the FAM14. For this it is necessary that a device address is assigned by the radio antenna module FAM14 as described in the user manual. This single-phase energy meter measures active energy by means of the current between input and output. The internal power consumption of 0.4 watt active power is neither metered nor indicated. 1 phase conductor with a max. current up to 32 A can be connected.

The start current is 20 mA. Accuracy class B (1%).

If the anticipated load exceeds 50%, maintain an air gap of ½ pitch unit to the devices mounted adjacently. For this purpose, the scope of delivery includes 2 spacers DS14 and, in addition to the short jumper, two more long jumpers. Two N terminals for secure cross wiring of several counters.

The consumption value is stored in non-volatile memory and is displayed again immediately after a power failure. **The 7 segment LC display is also legible twice within a period of 2 weeks without power supply. Press the button.**

Below the display there is a button with which you can scroll through the menu according to the operating instructions. First the **background lighting** switches on. The display then shows the total active energy, the active energy of the resettable memory and the instantaneous values of power, voltage, current as well as the Pch value can be displayed. Power consumption is shown by a bar flashing at a rate of 1000 times per kWh and with a red LED flashing 2000 times per kWh..

Error message

In case of a connection error, the background lighting of the display flashes.

Meter special operating modes:

In the meter operating modes, the focus is on the adjustable transmission speed of electricity meter data for external building energy managers. Data can be accessed and forwarded via gateways connected to the FAM14 (FGW14, FGW14-USB, FGW14W(L)-IP). **Additional setting options are available on the FAM14 for meters from production week 33/23.**

WSZ14DRS-32A MID	Single phase energy meter, MID	Art. No. 28032715	75,00 €/pc.
-------------------------	--------------------------------	--------------------------	--------------------

FWZ14-65A

RS485 bus single-phase energy meter transmitter module, maximum current 65 A. Only 0.5 watt standby loss.

Modular device for DIN-EN 60715 TH35 rail mounting. 1 module = 18 mm wide, 58 mm deep. Accuracy class B (1%). With RS485 interface.

Connection to the Eltako-RS485 bus. Bus cross wiring and power supply with jumper.

The meter reading, the current power and the serial number will be handed over to the bus - eg for forwarding to an external computer or Professional Smart Home controller - and also to the wireless network via FAM14. For this it is necessary that a device address is assigned from the wireless antenna module FAM14, according to the manual. It measures active energy by means of the current between input and output. The internal power consumption of 0.5 watt active power is not metered. Like all meters without declaration of conformity (e.g. MID), this meter is not permitted for billing. 1 phase conductor with a max. current up to 65 A can be connected. The inrush current is 40 mA. In operation the rotary switch must be set to AUTO. Power consumption is indicated using a LED. If the L input and the L output were interchanged when hooked up, a normal rate (HT)/off-peak (NT) switchover telegram is transmitted to indicate the hook-up error. If the anticipated load exceeds 50%, maintain an air gap of ½ pitch unit to the devices mounted adjacently. Thereto included are 2 spacers DS14, a short jumper and two long jumpers.

FWZ14-65A	RS485 bus wireless single-phase energy meter	Art. No. 30014050	82,10 €/pc.
------------------	--	--------------------------	--------------------

10-14

Further settings can be made using the PC Tool PCT14 (see page 1-5).

Manuals and documents in further languages:
<http://eltako.com/redirect/WSZ14DRS-32A>

Technical data page 10-27.



Further settings can be made using the PC Tool PCT14 (see page 1-5).

Manuals and documents in further languages:
<http://eltako.com/redirect/FWZ14-65A>



Further settings can be made using the PC Tool PCT14.



Manuals and documents in further languages:
<http://eltako.com/redirect/F3Z14D>

F3Z14D



**Wireless meter concentrator for electricity, gas and water meters.
 For 3 S0 interfaces and/or 3 AFZ scanners, only 0.1 watt standby loss.**

Modular device for DIN-EN 60715 TH35 rail mounting. 1 modul = 18 mm wide, 58 mm deep.

Connection to the Eltako-RS485 bus. Bus cross wiring and power supply with jumper.

This meter concentrator concentrates the data of up to three electricity, data and water meters and supplies this data to the RS485 bus. Either for forwarding to an external computer or for sending over the Wireless Building System.

Hook-up is either by connection to the S0 interface of the meters or by use of an AFZ scanner on each Ferraris meter. The scanner is bonded above the rotary disc of the meter and connected by its connecting wire to one of the S01-S03/GND terminals. The F3Z14D detects automatically whether an S0 interface or an AFZ is connected.

The meter reading is entered into the display by two pushbuttons as well as the impulse rate (number of impulses or revolutions per kilowatt hour or cubic meter). The settings can be locked.

Meter readings can be entered and read out using the **PCT14 PC Tool**. In addition, impulse rates can be entered. The default display is selectable and operation of the device is interlocked.

The display is subdivided into 3 fields.

Field 1:

The default display is the unit of the meter reading currently displayed in Field 3, either in kilowatt hours kWh or megawatt hours MWh or cubic meter M3 or cubic decametre DM3

Field 2:

Momentary value of active power in watts and kilowatts or flow in centilitres and decilitres.

The arrow on the left in display field 1 indicates automatic switchover from 0-99 W or cl/s to 0.1 to 65 kW or dal/s. The display depends on the number of impulses of the meter.

The displayed minimum load is e.g. 10 watts at 2000 impulses per KWH and 2000 watts at 10 impulses per KWH.

Field 3:

The meter reading is the default display. Every 4 seconds, the display alternates between 3 integer numbers and 1 decimal point (from 0 to 999.9) and an additional 1 or to 3 integer numbers (from 0 to 999).

Select meter in display:

Press MODE and then press MODE again to select the **ANZ function**. Press SET to select the meter number to be displayed as default. Press MODE to confirm.

Issue device address in the bus and send teach-in telegrams as described in the operating instructions.

All Eltako energy meters are fitted with an S0 interface and can therefore be connected to the energy meter concentrator F3Z14D. Only devices FWZ14-65A, DSZ14DRS-3x80A and DSZ14WDRS-3x5A are directly connected to the bus.

F3Z14D	RS485 bus meter collector	Art. No. 30014055	60,90 €/pc.
--------	---------------------------	-------------------	-------------

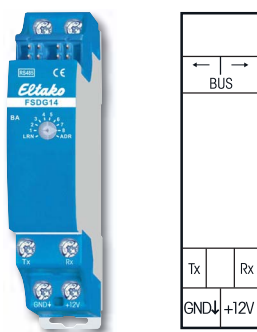

FSDG14



Wireless energy meter data gateway for meters equipped with an IEC 62056-21 IR interface. 2 channels. Only 0.4 watt standby loss.

Modular device for DIN-EN 60715 TH35 rail mounting. 1 module = 18 mm wide, 58 mm deep.

Connection to the Eltako-RS485 bus. Bus cross wiring and power supply with jumper.

This energy meter data gateway can provide the data of an electronic domestic supply meter (eHZ-EDL) with IR interface according to IEC 62056-21 and SML protocol version 1 to the RS485 bus. Either for forwarding to an external computer or controller.

Regular flashing of the **green LED** indicates that the FSDG14 is receiving data from the meter. Active power, up to 4 meter readings and the serial number are transferred. The serial number corresponds to the last 4 bytes (hex) of the server ID printed on the meter. The telegram is sent over the wireless building service by means of the wireless antenna module FAM14. Usage data are transmitted over channel 1 and delivery data over channel 2. It is therefore essential for the FAM14 to issue a device address. If there is a change in active power or a meter reading, the appropriate telegram is sent immediately and all telegrams including the serial number are sent cyclically every 10 minutes.

Also display with FEA65D.

The PCT14 PC tool can also read out the FSDG14.

Turn the rotary switch to select the following operating modes (OBIS codes according to IEC 62056-61):

- 1: Usage meter (1.8.0) and usage power on channel 1, delivery meter (2.8.0) and delivery power on Channel 2.
- 2: Usage tariff 1 (1.8.1) and tariff 2 (1.8.2) and usage power on channel 1, delivery tariff 1 (2.8.1) and tariff 2 (2.8.2) and delivery power on channel 2.
- 3: Usage tariff 1 (1.8.1) and tariff 2 (1.8.2) and usage power on channel 1, delivery meter (2.8.0) and delivery power on Channel 2.
- 4: Usage meter (1.8.0) and usage power on channel 1, delivery tariff 1 (2.8.1) and tariff 2 (2.8.2) and delivery power on channel 2.

The link is made by using an AIR IR scanner. The scanner is attached by its fixing magnets to the IR output of the meter and is connected by its connecting cable to terminals Rx, GND and +12 V.

Function rotary switch

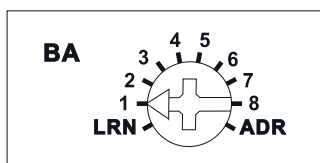

Standard setting ex works.

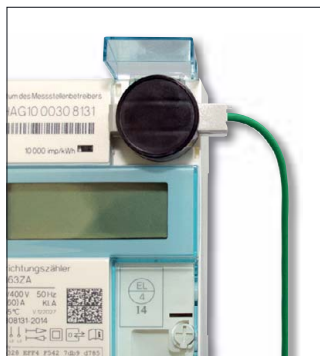

IR scanner for energy meters



Manuals and documents in further languages:
<http://eltako.com/redirect/FSDG14>



Manuals and documents in further languages:
<http://eltako.com/redirect/AIR>

FSDG14	RS485 bus energy meter data gateway	Art. No. 30014066	59,60 €/pc.
AIR	IR scanner for energy meters	Art. No. 30000970	111,10 €/pc.

MULTIFUNCTION CURRENT RELAY FOR BIDIRECTIONAL THREE-PHASE METERS MFSR12DX-230V

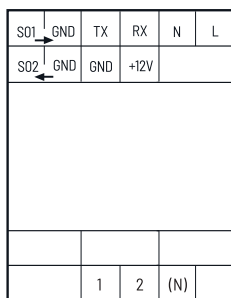

Function rotary switches

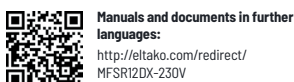
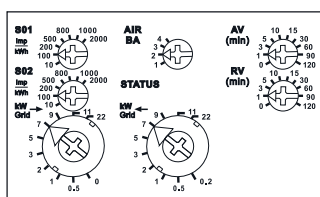

Technical data page 10-27.
 Housing for operating instructions
 GBA14 page 1-49 chapter 1.

MFSR12DX-230V



Multifunction current relay for bidirectional three-phase meters with two S0 outputs or IR interface according to IEC 62056-21. 1 NO contact potential free 16 A/250 V AC, with DX technology. Standby loss 0.6 watt only.

Modular device for DIN-EN 60715 TH35 rail mounting.
 3 modules = 54 mm wide, 58 mm deep.

This current relay either evaluates the data of a balancing bidirectional three-phase meter, e.g. DSZ15DZ-3x80A with two S0 interfaces, or that of an electronic household meter (eHZ-EDL) with IR interface according to IEC 62056-21 and SML protocol version 1.

The data for the power consumed (→) and the power supplied (←) are recorded, evaluated and a relay contact is switched on or off according to the settings.

With the patented Eltako Duplex technology (DX) the normally potential-free contact can still switch in zero passage when switching 230 V AC 50Hz and therefore drastically reduce wear. Simply connect the neutral conductor to the terminal (N) for this. This results in an standby consumption of only 0.1 watt. Supply voltage 230 V.

If the supply voltage fails, the switching status is retained. When the supply voltage returns, it is defined switched off.

S0 inputs S01 (consumed power →) and S02 (delivered power ←).

The S0 pulses/kWh of the electricity meter used are set with the respective rotary switch.
 Adjustable values are 10, 100, 200, 500, 800, 1000, 2000 Imp/kWh.

AIR input (OBIS codes according to IEC 62056-61)

With the rotary switch AIR (BA) you can choose between the following operating modes:

- 1: Purchase totalizer (1.8.0) and reference power on channel 1, supply totalizer (2.8.0) and supply power on channel 2.
- 2: Purchase of tariff 1 (1.8.1) and tariff 2 (1.8.2) and reference power on channel 1, supply of tariff 1 (2.8.1) and tariff 2 (2.8.2) and supply of power on channel 2.
- 3: Import tariff 1 (1.8.1) and tariff 2 (1.8.2) and import power on channel 1, supply totalizer (2.8.0) and supply power on channel 2.
- 4: Purchase totalizer (1.8.0) and reference power on channel 1, supply tariff 1 (2.8.1) and tariff 2 (2.8.2) and supply power on channel 2.

If no AIR is used, the rotary switch must be set to the right stop.

The connection is made using an IR scanner AIR. The IR scanner is fixed with its fastening magnet over the IR output of the meter and connected with its connection cable to the Rx, GND and +12 V terminals.

Setting the switching threshold for the reference power (kW grid →)

The switching threshold at which the relay should switch off is set with the rotary switch (kW Grid →). The adjustable values for the power are 0, 0.5, 1, 2, 3, 5, 7, 9, 11, 22 kW.

Setting the switching threshold for the delivery power (kW grid ←)

The switching threshold at which the relay should switch on is set with the rotary switch (kW Grid ←). The adjustable values for the power are 0.2, 0.5, 1, 2, 3, 5, 7, 9, 11, 22 kW.

Functionality:

Turn on relay contact 1-2

When the set power for the energy supply (←) is reached, the **response delay time (AV)** begins, which can be set between 0, 1, 3, 5, 10, 15, 30, 60, 90, 120 minutes with the rotary switch (AV). The red LED behind the rotary switch (AV) flashes as long as the AV time is running. At the end of the AV time, the relay contact switches on if the power (kW) has not fallen below the set switching threshold again. The red STATUS LED lights up as long as the relay contact is closed.

Switching off relay contact 1-2

When the set power for the energy consumption (→) is reached, the **off-delay time (RV)** begins, which can be set between 0, 1, 3, 5, 10, 15, 30, 60, 90, 120 minutes with the rotary switch (RV). The red LED behind the rotary switch (RV) flashes as long as the RV time is running. At the end of the RV time, the relay contact switches off if the power (kW) has not fallen below the set switching threshold again. The red STATUS LED goes out when the relay contact is open.

MFSR12DX-230V	Multifunction current relay for bidirectional three-phase meters MFSR12DX-230V	Art. No. 22100530	104,10 €/pc.
----------------------	--	--------------------------	---------------------

**SINGLE-PHASE ENERGY METER WSZ15D-32A MID AND
SINGLE-PHASE ENERGY METER WSZ15DE-32A, WITHOUT MID**



Typical connection

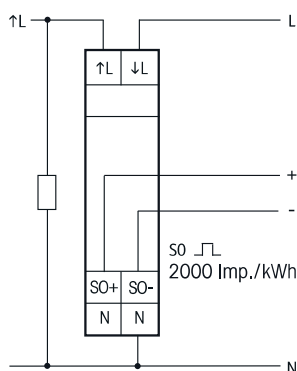

Manuals and documents in further languages:
http://eltako.com/redirect/WSZ15D-32A_MID

Technical data page 10-27.



Typical connection

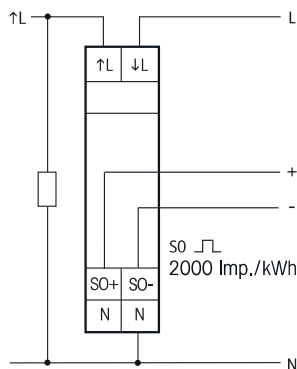

Manuals and documents in further languages:
<http://eltako.com/redirect/WSZ15DE-32A>

Technical data page 10-27.

Recommended retail prices excluding VAT.

WSZ15D-32A MID

MID

Maximum current 32 A. Standby loss 0.4 watt only.

Modular device for DIN-EN 60715 TH35 rail mounting.

1 module = 18 mm wide and 58 mm deep.

Accuracy class B (1%). With SO interface.

This single-phase energy meter measures active energy by means of the current between input and output. The internal power consumption of 0.4 watt active power is neither metered nor indicated.

1 phase conductor with a max. current of up to 32 A can be connected.

The start current is 20 mA.

If the anticipated load exceeds 50%, maintain an air gap of 1/2 pitch unit to the devices mounted adjacently.

If necessary, use spacer DS12.

Two N terminals for secure cross wiring of several counters.

The 7 segment LC display is also legible twice within a period of 2 weeks without power supply.

Press the button.

Below the displays is a button which you can use to browse through the menu as described in the User Manual. First the **background lighting** switches on. Then you can display the total active energy, active energy of the resettable memory and the instantaneous values for active power, voltage and current.

Power consumption is shown by a bar flashing at a rate of 1000 times per kWh.

Error message

In the event of a connection error the backlighting of the display flashes.

WSZ15D-32A MID	Single-phase energy meter, MID approval	Art. No. 28032015	67,00 €/pc.
-----------------------	---	--------------------------	--------------------

WSZ15DE-32A

Maximum current 32 A. Standby loss 0.4 watt only.

Modular device for DIN-EN 60715 TH35 rail mounting.

1 module = 18 mm wide and 58 mm deep.

Accuracy class B (1%). With SO interface.

It measures active energy by means of the current between input and output. The internal power consumption of 0.4 watt active power is neither metered nor indicated. Like all meters without declaration of conformity (e.g. MID), this meter is not permitted for billing.

Every 30 seconds, the display switches for 5 seconds from the accumulated active energy in kWh to the momentary consumption in watts.

1 phase conductor with a max. current up to 32 A can be connected. If the anticipated load exceeds 50%, maintain an air gap of 1/2 pitch unit to the devices mounted adjacently.

If necessary, use spacer DS12. The inrush current is 20 mA. The display can only be read when the power supply is on. However, the consumption is saved to a non-volatile memory and is displayed immediately after power restoration.

Two N terminals for secure cross wiring of several counters.

The digital display has 7 digits. Two decimal places are indicated up to 99999.99 kWh. Above 100000.0 kWh there is only one decimal place.

Power consumption is shown by a bar flashing at a rate of 1000 times per kWh.

Error message

In the event of a connection error a LED in the display flashes.

WSZ15DE-32A	Single-phase energy meter, without MID	Art. No. 28032615	59,00 €/pc.
--------------------	--	--------------------------	--------------------



Typical connection

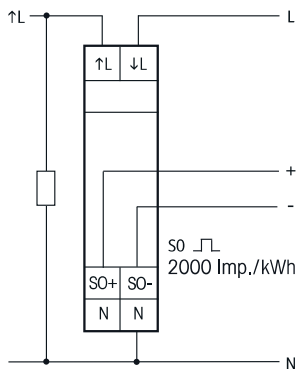

Manuals and documents in further languages:
http://eltako.com/redirect/WSZ15D-65A_MID

Technical data page 10-27.

WSZ15D-65A MID

MID

Maximum current 65 A. Standby loss 0.4 watt only.

Modular device for DIN-EN 60715 TH35 rail mounting.

1 module = 18 mm wide and 58 mm deep.

Accuracy class B (1%). With SO interface.

This single-phase energy meter measures active energy by means of the current between input and output. The internal power consumption of 0.4 watt active power is neither metered nor indicated.

1 phase conductor with a max. current up to 65 A can be connected.

The start current is 40 mA.

If the anticipated load exceeds 50%, maintain an air gap of 1/2 pitch unit to the devices mounted adjacently.

If necessary, use spacer DS12.

Two N terminals for secure cross wiring of several counters.

The 7 segment LC display is also legible twice within a period of 2 weeks without power supply.

Press the button.

Below the displays is a button which you can use to browse through the menu as described in the User Manual. First the **background lighting** switches on. Then you can display the total active energy, active energy of the resettable memory and the instantaneous values for active power, voltage and current. Power consumption is shown by a bar flashing at a rate of 1000 times per kWh.

Error message

In the event of a connection error the backlighting of the display flashes.

WSZ15D-65A MID	Single-phase energy meter, MID approval	Art. No. 28065615	71,50 €/pc.
-----------------------	---	--------------------------	--------------------

SINGLE-PHASE ENERGY METER WZR12-32A WITH RESET, WITHOUT MID

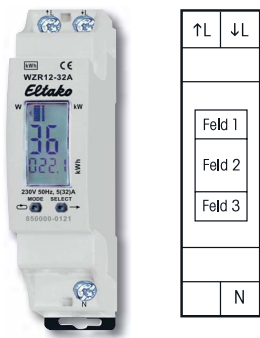

Typical connection

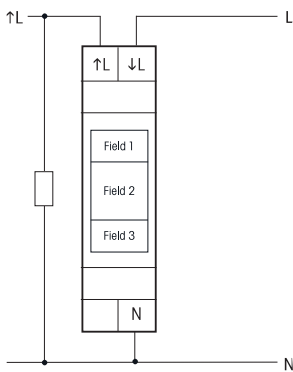

10-20

Manuals and documents in further languages:
<http://eltako.com/redirect/WZR12-32A>

WZR12-32A

Maximum current 32 A, standby loss 0.5 watt only.

Modular device for DIN-EN 60715 TH35 rail mounting.
 1 module = 18 mm wide, 58 mm deep.

This single-phase energy meter with reset function uses the current between input and output to measure active energy and saves the consumption parameter in a non-volatile memory.

Like all meters without declaration of conformity (e.g. MID), this meter is not permitted for billing. Accuracy conforms to Class B MID (1%) like all Eltako single-phase energy meters, the inrush current is 20 mA.

The display is subdivided into 3 fields.

Field 1:

This display refers to the cumulative value in field 3.

|||| moving slowly to the right = Field 3 shows the cumulative consumption since last reset. This is the display standard mode.

H01 = Field 3 shows the consumption for the last hour up to H24 = 24 hours ago.

D01 = Field 3 shows the consumption for the last day up to D95 = 95 days ago.

Field 2:

Instantaneous values of energy consumption (active power) in watt (W) or kilowatt (kW).

The display arrows on the left and right show the automatic change W and kW.

Field 3:

Cumulative value up to 9999 kWh. Display up to 9.999 kWh with 3 decimal digits, from 10 kWh with 1 decimal digit and from 1000 kWh without decimal digit.

Press the left button MODE to scroll down the display options which are shown in field 1:

H01 and D01 as described above. Finally, press MODE to show the abbreviation of the set language, e.g. GB for English, D for German, F for French and ES for Spanish.

Press the right button SELECT once within the display options to increment the indicated figure by 1.

The corresponding value is indicated in field 3. The last clock hour then becomes the hour before last, etc. If the active language was selected with MODE, press SELECT to switch to a different language. Exit the new language setting by pressing MODE to activate the setting.

The program returns to the standard display mode automatically if MODE or SELECT are not operated for 20 seconds or if you press both buttons briefly simultaneously.

Reset

Hold down the buttons MODE and SELECT simultaneously for 3 seconds until RES appears in segment 1. Then press SELECT briefly to reset all memories. Afterwards the program returns automatically to standard display mode.

Error message

If the current direction is wrong, F01 is shown on the display.

Technical data page 10-27.

WZR12-32A	Single-phase energy meter with reset, without MID	Art. No. 28032410	74,50 €/pc.
------------------	---	--------------------------	--------------------

MOBILE SINGLE-PHASE ENERGY METER WSZ110DSS-16A MID
MOBILE SINGLE-PHASE ENERGY METER WSZ110DSS-16A+PRCD MID

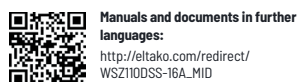

Manuals and documents in further languages:
http://eltako.com/redirect/WSZ110DSS-16A_MID

Technical data page 10-27.

WSZ110DSS-16A MID

MID

Mobile single-phase energy meter with German type plug and coupling (Type F). Suitable for indoor and outdoor use. Maximum current 16 A, Standby loss 0,4 watt only.

Housing dimensions 110x70x35 mm, connection cable 1.5 m (including plug and coupling). Accuracy class B (1%).

This mobile single-phase energy meter measures active energy by means of the current between input and output. The internal power consumption of 0.4 watt active power is neither metered nor indicated. **Every 30 seconds, the display switches for 5 seconds from the accumulated active energy in kWh to the momentary consumption in watts.**

The start current is 20 mA.

The display can only be read when the power supply is on. However, the consumption is saved to a non-volatile memory and is displayed immediately after a power failure.

The digital display has 7 digits.

Two decimal places are indicated up to 99999.99 kWh.

Above 100000.0 kWh there is only one decimal place.

Power consumption is shown by a LED flashing at a rate of 2000 times per kWh.

WSZ110DSS-16A MID	Mobile single-phase energy meter with MID	Art. No. 28016110	106,30 €/pc.
--------------------------	---	--------------------------	---------------------



Manuals and documents in further languages:
http://eltako.com/redirect/WSZ110DSS-16A*PRCD_MID

WSZ110DSS-16A+PRCD MID

MID

Mobile single-phase energy meter with German type plug and coupling (Type F). With additional residual current circuit breaker PRCD 30 mA. Suitable for indoor and outdoor use. Maximum current 16 A. Standby loss 0.4 watt only.

Housing dimensions 110x70x35 mm, connection cable 1.5 m (including plug and coupling). Accuracy class B (1%).

This mobile single-phase energy meter measures active energy by means of the current between input and output. The internal power consumption of 0.4 watt active power is neither metered nor indicated. **Every 30 seconds, the display switches for 5 seconds from the accumulated active energy in kWh to the momentary consumption in watts.**

The start current is 20 mA.

The display can only be read when the power supply is on. However, the consumption is saved to a non-volatile memory and is displayed immediately after a power failure.

The digital display has 7 digits.

Two decimal places are indicated up to 99999.99 kWh.

Above 100000.0 kWh there is only one decimal place.

Power consumption is shown by a LED flashing at a rate of 2000 times per kWh.

The personal protection intermediate switch PRCD detects fault currents that occur, for example, when a faulty electrical device is touched, and interrupts the current so quickly that life-threatening accidents can be prevented. It also has an undervoltage release that switches off in the event of a mains voltage failure. With function indication and test button.

WSZ110DSS-16A+PRCD MID	Mobile single-phase energy meter personal protection intermediate switch PRCD, with MID	Art. No. 28016112	206,20 €/pc.
-------------------------------	---	--------------------------	---------------------

MOBILE SINGLE-PHASE ENERGY METER WSZ110CEE-16A MID
MOBILE SINGLE-PHASE ENERGY METER WSZ110CEE-16A+PRCD MID



Manuals and documents in further languages:
http://eltako.com/redirect/WSZ110CEE-16A_MID

Technical data page 10-27.

WSZ110CEE-16A MID

MID

Mobile single-phase energy meter with CEE plug and CEE coupling. Suitable for indoor and outdoor use. Maximum current 16 A. Standby loss 0,4 watt only.

Housing dimensions 110x70x35 mm, connection cable 1.5 m (including plug and coupling).

Accuracy class B (1%).

This mobile single-phase energy meter measures active energy by means of the current between input and output. The internal power consumption of 0.4 watt active power is neither metered nor indicated.

Every 30 seconds, the display switches for 5 seconds from the accumulated active energy in kWh to the momentary consumption in watts.

The start current is 20 mA.

The display can only be read when the power supply is on. However, the consumption is saved to a non-volatile memory and is displayed immediately after a power failure.

The digital display has 7 digits.

Two decimal places are indicated up to 99999.99 kWh.

Above 100000.0 kWh there is only one decimal place.

Power consumption is shown by a LED flashing at a rate of 2000 times per kWh.

WSZ110CEE-16A MID	Mobile single-phase energy meter with MID	Art. No. 28016111	107,40 €/pc.
--------------------------	---	--------------------------	---------------------

10-22



Manuals and documents in further languages:
http://eltako.com/redirect/WSZ110CEE-16A*PRCD_MID

WSZ110CEE-16A+PRCD MID

MID

Mobile single-phase energy meter with CEE plug and CEE coupling. With additional residual current circuit breaker PRCD 30 mA. Suitable for indoor and outdoor use. Maximum current 16 A. Standby loss 0,4 watt only.

Housing dimensions 110x70x35 mm, connection cable 1.5 m (including plug and coupling).

Accuracy class B (1%).

This mobile single-phase energy meter measures active energy by means of the current between input and output. The internal power consumption of 0.4 watt active power is neither metered nor indicated.

Every 30 seconds, the display switches for 5 seconds from the accumulated active energy in kWh to the momentary consumption in watts.

The start current is 20 mA.

The display can only be read when the power supply is on. However, the consumption is saved to a non-volatile memory and is displayed immediately after a power failure.

The digital display has 7 digits.

Two decimal places are indicated up to 99999.99 kWh.

Above 100000.0 kWh there is only one decimal place.

Power consumption is shown by a LED flashing at a rate of 2000 times per kWh.

The personal protection intermediate switch PRCD detects fault currents that occur, for example, when a faulty electrical device is touched, and interrupts the current so quickly that life-threatening accidents can be prevented. It also has an undervoltage release that switches off in the event of a mains voltage failure. With function indication and test button.

WSZ110CEE-16A+PRCD MID	Mobile single-phase energy meter personal protection intermediate switch PRCD, with MID	Art. No. 28016113	202,40 €/pc.
-------------------------------	---	--------------------------	---------------------

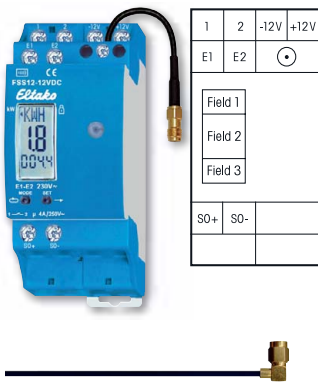

The enclosed small antenna can be replaced with a wireless antenna FA250 or if need be FA200 and FAG55E- (see page 1-4).

Typical connection

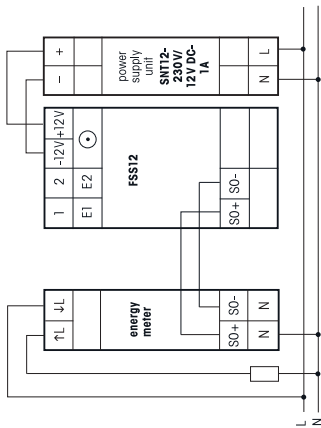

Manuals and documents in further languages:
http://eltako.com/redirect/FSS12-12V_DC

FSS12-12V DC

Wireless energy meter transmitter module for connection to S0 interface of many single-phase energy meters and three-phase energy meters. Only 0.5 watt standby loss. With load shedding relay 1 NO contact potential free 4 A/250 V and with exchangeable antenna. If required, a wireless antenna FA250 or FAG55E- can be connected.

Modular device for DIN-EN 60715 TH35 rail mounting.
 2 modules = 36 mm wide, 58 mm deep.

The energy meter transmitter module FSS12 evaluates the signals of the S0 interface of an electricity meter and sends wireless telegrams with the consumption and the meter reading to the Eltako wireless building for evaluation with the controller. On three-phase energy meters, the data sent includes normal rate (HT) or off-peak (NT) energy tariff data, provided the E1/E2 terminals on the three-phase energy meter are connected to E1/E2 on the FSS12.

With adjustable pulse rate.

The 12 V DC supply voltage is powered at 12 W by a wide-range power supply unit WNT15-12VDC/24W that is only 1 pitch unit wide.

If the relay of the FSS12 is switched on, a power of 0.6 watts is required.

The setting and display screen is subdivided into 3 fields:

- **Field 1:** The normal display is the unit of the meter reading currently displayed in Field 3. This alternates every 4 seconds with either kilowatt hours kWh (KWH in display) or megawatt hours MWh (MWH in display). The display in Field 1 is supplemented by a + sign after the reading to indicate that the off-peak tariff rate is applied to E1/E2.
- **Field 2:** Instantaneous values of energy consumption (active power) in watt (W) or kilowatt (kW). The left-pointing arrow in Field 1 indicates an automatic switchover from 0 to 99 W to 0.1 to 65 kW.
- **Field 3:** The meter reading is the normal display. Every 4 seconds the display alternates between 3 whole numbers and 1 decimal point (from 0.1 to 999.9 kWh) and 1 or max 3 whole numbers (from 0 to 999 MWh). At freely chosen pulse rates whose last digit is not 0, the meter reading is displayed without decimal place in increments of 1 kWh.

Wireless telegrams: Maximum every 130 seconds a performance telegram will be sent and the display will be updated. Otherwise a telegram will be sent within 20 seconds if the power changed by at least 10%.

A switchover from HT to NT is transmitted immediately in the same way as a meter reading change. A full telegram comprising meter reading HT, meter reading NT and power is transmitted 20 seconds after the power supply is switched on and then every 10 minutes. Settings with the MODE and SET buttons according to the operating instructions.

FSS12-12V DC	Wireless energy meter transmitter module	Art. No. 30100600	112,10 €/pc.
---------------------	--	--------------------------	---------------------

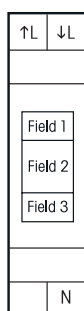

Typical connection

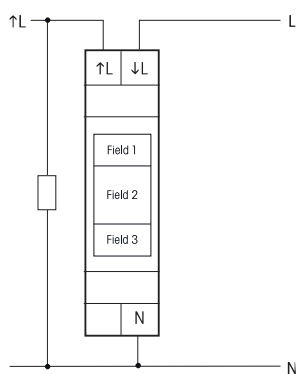

10-24



Manuals and documents in further languages:
<http://eltako.com/redirect/EVA12-32A>

EVA12-32A

Maximum current 32 A, standby loss 0.5 watt only.

Modular device for DIN-EN 60715 TH35 rail mounting.
 1 module = 18 mm wide, 58 mm deep.

The energy consumption indicator EVA12 uses the current between input and output to measure active energy in the same way as a single-phase energy meter. It saves the consumption parameter in a non-volatile memory.

Like all meters without declaration of conformity (e.g. MID), this meter is not permitted for billing. Accuracy conforms to Class B MID (1%) like all Eltako single-phase energy meters. The inrush current is 20 mA.

In this way the energy consumption indicator reproduces exactly the reading on the billing energy meter installed at a different location in the building.

The display is subdivided into 3 fields.

Field 1:

This display refers to the cumulative value in field 3.

||| moving slowly to the right = Field 3 shows the cumulative consumption since last reset. This is the display standard mode.

H01 = Field 3 shows the consumption for the last hour up to H24 = 24 hours ago.

D01 = Field 3 shows the consumption for the last day up to D31 = 31 days ago.

M01 = Field 3 shows the consumption for the last month up to M12 = 12 months ago.

Y01 = Field 3 shows the consumption for the last year up to Y24 = 24 years ago.

Field 2:

Instantaneous values of energy consumption (active power) in watt (W) or kilowatt (kW). The display arrows on the left and right show the automatic change W and kW.

Field 3:

Cumulative value in kWh. Display up to 9.999 kWh with 3 decimal digits, from 10 kWh with 1 decimal digit and from 1000 kWh without decimal digit.

Press the left button MODE to scroll down the display options which are shown in field 1:

H01, D01, M01 and Y01 as described above. Finally, press MODE to show the abbreviation of the set language, e.g. GB for English, D for German and F for French.

Press the right button SELECT once within the display options to increment the indicated figure by 1. The corresponding value is indicated in field 3. The last clock hour then becomes the hour before last, etc. If the active language was selected with MODE, press SELECT to switch to a different language. Exit the new language setting by pressing MODE to activate the setting.

The program returns to the standard display mode automatically if MODE or SELECT are not operated for 20 seconds or if you press both buttons briefly simultaneously.

Reset

To start saving the values to the nearest hour, we recommend performing a reset at an opportune moment after installation. Hold down the buttons MODE and SELECT simultaneously for a further 3 seconds until RES appears in field 1. Then press SELECT briefly to reset all memories. Afterwards the program returns automatically to standard display mode.

Technical data page 10-27.

EVA12-32A	Single-phase energy meter with energy consumption indicator	Art. No. 28032411	75,10 €/pc.
------------------	---	--------------------------	--------------------

WIRELESS SINGLE-PHASE ENERGY METER FWZ12-65A
WIRELESS OUTDOOR SOCKET ENERGY METER FASWZ-16A



Manuals and documents in further languages:
<http://eltako.com/redirect/FWZ12-65A>

FWZ12-65A

Wireless single-phase energy meter, maximum current 65 A. Only 0.5 watt standby loss.

Modular device for DIN-EN 60715 TH35 rail mounting. 1 module = 18 mm wide, 58 mm deep. This single-phase energy meter measures active energy by means of the current between input and output and transmits the current power and meter reading over the Eltako wireless network. Accuracy class B (1%).

Evaluation and smart link via controller.

The internal power consumption of max. 0.5 watt active power is not metered. Like all meters without declaration of conformity (e.g. MID), this meter is not permitted for billing. 1 phase conductor with a max. current up to 65 A can be connected. If the anticipated load exceeds 50%, maintain an air gap of 1/2 pitch unit to the devices mounted adjacently. If necessary, use spacer DS12. The inrush current is 40 mA. The consumption is saved to a non-volatile memory and is immediately available again after a power failure.

Wireless telegrams: A telegram is transmitted within 60 seconds if the power status changes by min. 10 percent. A change in meter reading is transmitted immediately. A full telegram comprising meter reading and power status is transmitted every 10 minutes. When the power supply is switched on, a **teach-in telegram** is sent to teach in the associated energy consumption indicator.

If the L input and the L output were interchanged when hooked up, a normal rate (HT)/off-peak (NT) switch-over telegram is transmitted to indicate the hook-up error.

FWZ12-65A	Wireless single-phase energy meter	Art. No. 30000308	95,50 €/pc.
------------------	------------------------------------	--------------------------	--------------------



WEEE registration number DE 30298319



Manuals and documents in further languages:
<http://eltako.com/redirect/FASWZ-16A>

FASWZ-16A

Wireless outdoor socket energy meter, maximum current 16 A. 116x56x46 mm (measurements without plug), black. Suitable for both indoors and outdoors, IP44 (splash-proof). Only 0.4 watt standby loss. Smart Home actuator.

Adapter for German Socket (Type F). With increased shock protection. This single-phase energy meter measures active energy by means of the current between input and output and transmits the consumption and meter reading over the Eltako wireless network. Accuracy class B (1%).

Evaluation and smart connection via a controller.

The internal power consumption of max. 0.4 watt active power is not metered. The inrush current is 20 mA. The consumption is saved to a non-volatile memory and is immediately available again after a power failure.

Wireless telegrams: A telegram is transmitted within 30 seconds if the power status changes by min. 10 percent. A change in meter reading is transmitted immediately. A full telegram comprising meter reading and power status is transmitted every 10 minutes. After plugging in the counter and also when pressing the *LRN* button, a **learn telegram**, a counter reading telegram and a power telegram are sent.

FASWZ-16A	Wireless outdoor socket energy meter	Art. No. 30100015	114,90 €/pc.
------------------	--------------------------------------	--------------------------	---------------------

WIRELESS ACTUATOR SOCKET SWITCHING ACTUATOR WITH CURRENT MEASUREMENT FSVA-230V-10A



Manuals and documents in further languages:
<http://eltako.com/redirect/FSVA-230V-10A>

FSVA-230V-10A

1 NO contact not potential free 10 A/250 V AC, incandescent lamps up to 2000 watts, LED and ESL up to 400 W. With integrated current measurement up to 10 A. Encrypted wireless, bidirectional wireless and repeater function are switchable. Only 0.8 watt standby loss.

Adapter for German fused safety socket. With increased shock protection. Supply and switching voltage 230 V. In case of failure of the supply voltage, the switching state is maintained. The recurrent supply voltage is disconnected in a definite sequence. After plugging wait for short automatic synchronization before the switched consumer is plugged.

This wireless actuator features state-of-the-art hybrid technology that we developed: we combined the wear-free receiver and evaluation electronics and a bistable relay.

Apparent power is measured by the integrated current measurement from approx. 10 VA to 2300 VA when the contact is closed. A wireless telegram is transmitted into the Eltako wireless network within 30 seconds after switching on the load or after a change in power by min 5% and cyclically every 10 minutes.

Evaluation and linking of scenes and automations via controller.

You can teach in encrypted sensors. You can switch on **bidirectional wireless** and/or a **repeater** function.

Every change in state and incoming central command telegrams are then confirmed by a wireless telegram. This wireless telegram can be taught into other actuators, Controllers and universal displays.

Up to 35 wireless pushbuttons are assigned **with the left button LRN**, either as a universal pushbutton,

direction pushbutton or central pushbutton. For the control of extractor hoods or similar items up to 35 wireless window door contacts FTK or wireless window handle sensors FFG7B-rw can be taught-in.















Several FTK or wireless window handle sensors FFG7B-rw are linked together. If a FTK or wireless window

handle sensor FFG7B-rw is taught-in, control commands of eventually taught-in pushbuttons are no longer running. It can be switched on and off manually **with the right button**. **The LED** performs during

the teach-in process according to the operation manual. It shows wireless control commands by short flickering during operation.

FSVA-230V-10A	Wireless actuator Socket switching actuator with current measurement	Art. No. 30100003	121,50 €/pc.
----------------------	--	--------------------------	---------------------

TECHNICAL DATA SINGLE-PHASE AND THREE-PHASE ENERGY METERS AND ENERGY CONSUMPTION INDICATOR

	EVA12-32A WSZ14DSR-32A  WSZ15D-32A  WSZ15DE-32A WZR12-32A WSZ110 	WSZ15D-65A 	DSZ15D-3x80A  DSZ15DE-3x80A DSZ15DM-3x80A  DSZ15DZ-3x80A  DSZ15DZE-3x80A DSZ15DZMOD-3x80A  DSZ14DRS-3x80A  DSZ14DRSZ-3x80A  DSZ180CEE 	DSZ15WD-3x5A  DSZ15WDM-3x5A  DSZ14WDRS-3x5A 
Rated voltage Extended range	230 V, 50 Hz -20%/+15%	230 V, 50 Hz -20%/+15%	3x230/400 V, 50 Hz -20%/+15%	3x230/400 V, 50 Hz -20%/+15%
Reference current I_{ref} (Limiting current I_{max})	5(32)A WSZ110: Rated current 16 A	10(65)A	3x10(80)A DSZ180CEE-32A: Rated current 32A DSZ180CEE-16A: Rated current 16A	3x5(6)A
Internal consumption active power	0.4 W EVA12, WZR12: 0.5 W	0.4 W	0.5 W per path DSZ14DRS: 0.8 W at L1	0.5 W per path DSZ14WDRS: 0.8 W at L1
Display	LC display 7 digits, therefrom 1 or 2 digits after the decimal point	LC display 7 digits, therefrom 1 or 2 digits after the decimal point	LC display 7 digits, therefrom 1 or 2 digits after the decimal point	LC display 7 digits, therefrom 1 digit after the decimal point
Display instantaneous values	WSZ15D: With a key you can select active power, voltage and current WSZ15DE, WSZ110: Active power displayed for 5 seconds every 30 seconds EVA12, WZR12: active power	With a key you can select active power, voltage and current	With a key you can select to- tal active energy and active energy resettable, power, voltage and current per phase tariff 1 and tariff 2 (not DSZ180)	With a key you can select total active energy and active energy resettable, power, voltage and current per phase
Accuracy class $\pm 1\%$	B	B	B	B
Inrush current according to accuracy class B	20 mA	40 mA	40 mA	10 mA
Operating temperature	-25/+55°C EVA12, WZR12: -10/+55°C	-25/+55°C	-25/+55°C	-25/+55°C
Interface (not DSZ180, EVA12, WZR12, WSZ110)	DSZ15DM and DSZ15WDM with M-Bus interface. DSZ15DZMOD with Modbus interface. DSZ14DRS, DSZ14DRSZ, DSZ14WDRS and WSZ14 DRS with interface for the Eltako RS485 bus. Otherwise pulse output S0 according to DIN EN 62053-31, potential-free through an optocoupler, max. 30 V DC/20 mA and min. 5 V DC. Impedance 100 ohms.			
	Pulse length 30 ms	Pulse length 30 ms	Pulse length 30 ms	Pulse length 30 ms
	2000 Imp./kWh	2000 Imp./kWh	1000 Imp./kWh	10 Imp./kWh
Terminal cover sealable	With sealing cap PK18. For the current path 1 sealing cap is required (not WSZ110)	With sealing cap PK18. For the current path 1 sealing cap is required	Terminal cover claps (not DSZ180)	Terminal cover claps
Protection degree	IP50 for mounting in distribution cabins with protection class IP51 WSZ110: IP54		IP50 for mounting in distribution cabins with protection class IP51 DSZ180: IP54	
Maximum conductor cross section	6 mm ² WSZ15D, WSZ15DE: L terminals 16 mm ² (not WSZ110)	L terminals 16 mm ² , N and S0 terminals 6 mm ²	N and L terminals 16 mm ² , S0, M-Bus and RS485 bus terminals 6 mm ² DSZ15D/DE/DM/DZ/DZE/DZMOD-3x80A, DSZ14DRS/DRSZ-3x80A: L terminals 25 mm ² (not DSZ180)	

The N terminal of three-phase energy meters must be connected, if not the electronics might be destroyed.

To comply with DIN VDE 0100-443 and DIN VDE 0100-534, a Type 1 or Type 2 surge protection device (SPD) must be installed.

MEASURING INSTRUMENTS DIRECTIVE MID

On 31.04.2004, the European Parliament and the Council adopted the European Measuring Instruments Directive (MID) 2004/22/EC. The MID came into force in all member states of the EU and in Switzerland on 30.10.2006. The 10 types of measuring instruments also include active electrical energy meters.

In the meantime, this has been replaced by directive 2014/32/EU of the European Parliament and of the Council of February 26, 2014 (new version).

The MID replaces previous regulations on national approval and subsequent calibration in the domestic, trade and light industry sectors.

A manufacturer's Declaration of Conformity was produced based on this new directive.

There is a type examination certificate or pattern examination certificate for each type.

The MID regulates the following:

- the technical requirements (standard series DIN EN 50470-1/-3)
- the conformity assessment procedure
- the putting into use of measuring instruments
- marking the measuring instruments
- market surveillance

National law continues to regulate the following:

- recalibration
- calibration validity
- charges

When an MID instrument is put into use, we declare conformity with the MID in the operating instructions. The number of the type examination certificate is also quoted there.

10-28

THE DEVICE BEARS THE MID CONFORMITY MARK THAT CONSISTS OF:

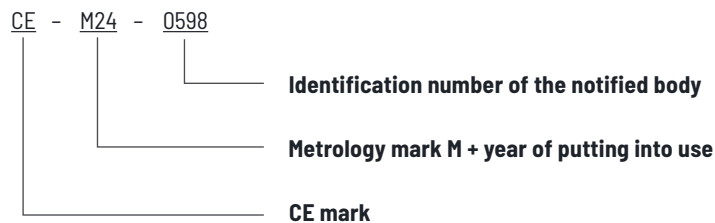

The year after the year of putting into use defines the recalibration time.

The period of calibration validity depends on the prevailing national law. In Germany, this is 8 years and can then be extended by a further 8 years by a state certified inspection body, i.e. not the manufacturer.

MID meters require no subsequent calibration with calibration mark. Instead, they are the equivalent of calibrated meters as a result of MID testing and an EU Declaration of Conformity from the manufacturer.

Conventional installation

Main meter 1 Main meter 2 Main meter 3

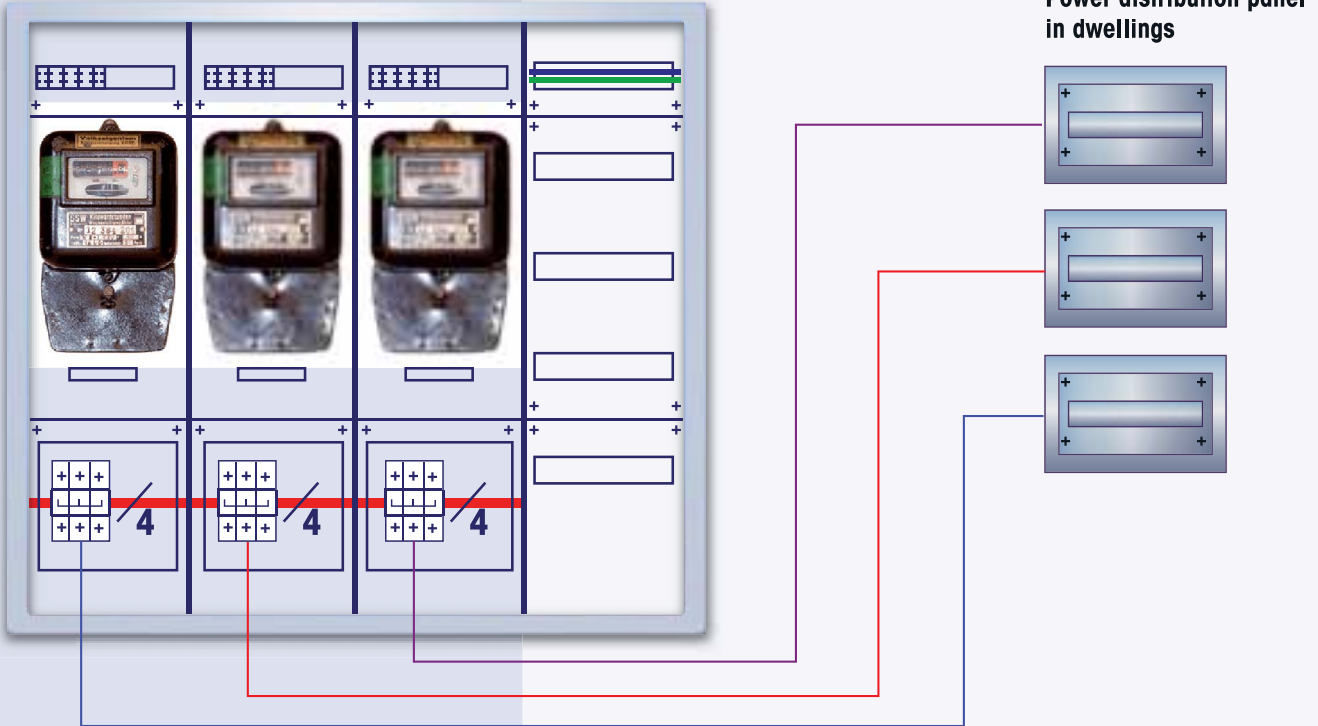

Modern installation acc. to TAB 2007

Main meter in meter cupboard

Dwelling meter with MID approval in power distribution

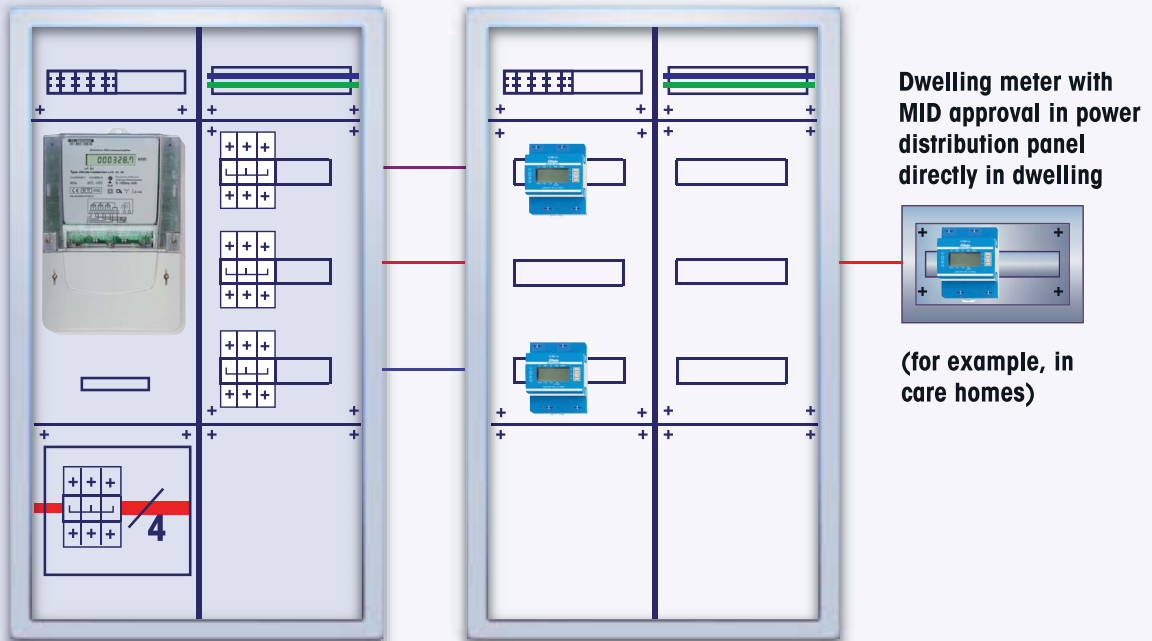

TAB

VDE

ESR12Z-4DX-UC
ESR12DDX-UC
ESR61NP-230V+UC



**ELECTRONIC IMPULSE SWITCHES -
THE SILENT REVOLUTION.**

Electronic impulse switches









Selection table electronic impulse switches	11-2
Impulse switch ES12DX-UC	11-3
Impulse switch with tungsten pre-contact ESW12DX-UC	11-4
Impulse switch ES12-200-UC	11-5
Impulse switch ES12-110-UC	11-6
Impulse switch with integrated relay function ESR12NP-230V+UC	11-7
Digital settable multifunction impulse switch with integrated relay function ESR12DDX-UC	11-8
Impulse switch with potential free contacts ES12Z-, also for central control	11-9
4-fold impulse switch with integrated relay function ESR12Z-4DX-UC, also for central control and group control	11-10
Impulse switch ES61-UC	11-11
Impulse switch for installation in lighting fittings ES75-12..24V UC	11-11
Impulse switch with integrated relay function ESR61NP-230V+UC	11-12
Multifunction impulse switch with integrated relay function ESR61M-UC	11-13
Noiseless impulse switch with integrated relay function ESR61SSR-230V with solid state relay	11-14
Technical data electronic impulse switches, also for central control	11-15

SELECTION TABLE ELECTRONIC IMPULSE SWITCHES

THE SILENT REVOLUTION

Without attracting particular attention by switching noise, the importance of electronic impulse switches with all their variants compared to conventional mechanical versions is growing steadily. They offer a highly reduced switching noise and further attractive

advantages, such as multifunction, central control, zero passage switching for AC voltage, minimized control power demand and universal control voltage.

Page	11-3	11-4	11-5	11-6	11-7	11-8	11-9	11-9	11-10	11-11	11-11	11-12	11-13	11-14	
	pictograms	ES12DX-UC	ESW12DX-UC	ES12-200-UC	ES12-110-UC	ESR12NP-230V+UC	ESR12DDX-UC	ES12Z-200-UC	ES12Z-110-UC	ESR12Z-4DX-UC	ES61-UC	ES75-12..24V UC	ESR61NP-230V+UC	ESR61M-UC	ESR61SSR-230V
Modular device for mounting on DIN rail EN 60715 TH35, number of modules 18 mm each	1	1	1	1	1	1	1	1	2						
Built-in device for installation (e.g. flush-mounting box)										■	■	■	■	■	
Number NO contacts (not potential free)	1	1	2	1	(1)	1+1 ³⁾ 2 ³⁾	2	1	4x1	1	(1)	(1)	1+1 ³⁾ 2 ³⁾	(1)	
Number NC contacts potential free				1		1-2 ³⁾		1					1-2 ³⁾		
Zero passage switching		■ ¹⁰⁾	■ ¹⁰⁾			■	■ ¹⁰⁾			■ ¹⁰⁾		■		■	
Switching capacity 16 A/250 V AC	■	■	■	■	■	■	■	■	■	■					
Switching capacity 10 A/250 V AC											■	■	■	■	
230 V LED lamps (W)	up to 600	up to 600	up to 200	up to 200	up to 600	up to 600	up to 200	up to 200	up to 600	up to 200	up to 200	up to 600	up to 200	up to 400	
Incandescent lamp load (W)	2000	3300	2000	2000	2300	2000	2000	2000	2000	2000	500	2000	2000	400	
Bistable relay(s) as relay contact(s)		■ ⁸⁾	■ ⁸⁾	■ ⁸⁾	■ ⁸⁾		■ ⁹⁾	■ ⁹⁾	■ ⁹⁾	■ ⁹⁾	■ ⁸⁾	■ ⁹⁾	■ ⁸⁾		
Universal control voltage		■	■	■	■	■	■	■	■	■	■	■	■		
Additional control voltage 230 V	■ ⁵⁾		■ ⁵⁾	■ ⁵⁾	■ ⁶⁾					■ ⁵⁾		■ ⁶⁾		■	
Control voltage 12 to 24 V UC											■				
Supply voltage same as control voltage							■	■	■	■				■	
Supply voltage 230 V						■ ⁶⁾						■	■ ⁶⁾	■	
No standby loss		■ ¹⁰⁾	■ ¹⁰⁾	■	■						■			■	
Low standby loss						■	■ ¹⁰⁾	■	■	■ ¹⁰⁾		■	■	■	
Glow lamp current (mA) at the control input 230 V		5 ¹⁾⁷⁾		5 ¹⁾⁷⁾	5 ¹⁾⁷⁾	150 ²⁾					5 ¹⁾⁷⁾		50 ²⁾⁷⁾		
Glow lamp current (mA) at the control input for universal voltage							5 ¹⁾	50 ¹⁾⁴⁾	50 ¹⁾⁴⁾						
Off delay, switch-off early warning function and permanent light by pushbutton can be switched on						■							■	■	
Multi circuit switch								■ ³⁾						■ ³⁾	
Group switch								■ ³⁾						■ ³⁾	
Central control electrically isolated from the local control									■	■	■				

¹⁾ Applies to glow lamps with 170 V ignition voltage, for glow lamps with 90 V ignition voltage approx. 1/2 glow lamp current. ²⁾ Glow lamp current independent from the ignition voltage. ³⁾ Depends on the set function. ⁴⁾ Will automatically be switched on starting at 110 V control voltage. ⁵⁾ Control with 230 V or low-voltage possible. ⁶⁾ If the control voltage is 230 V, but the phase conductor is different than the 230 V supply voltage, the universal voltage control input must be used due to the potential disconnection. ⁷⁾ At the control input . ⁸⁾ The relay contact can be open or closed when putting into operation. It will be synchronised at first operation. ⁹⁾ The switched consumer may not be connected to the mains before the short automatic synchronisation after installation has terminated. ¹⁰⁾ Patented Duplex technology: When switched with 230 V/50 Hz zero passage switching is activated if L is connected to (L) and N to (N). Then additional standby loss of only 0.1 watt.

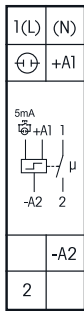

ES12DX-UC



1 NO contact potential free 16 A/250 V AC. 230 V LED lamps up to 600 W, incandescent lamp load up to 2000 W. No standby loss.

Modular device for DIN-EN 60715 TH35 rail mounting.
1 module = 18 mm wide, 58 mm deep.

With the patented Eltako Duplex technology (DX) the normally potential-free contacts can still switch in zero passage when switching 230 V AC 50 Hz and therefore drastically reduce wear.

Simply connect the neutral conductor to the terminal (N) and L to 1(L) for this. This results in an standby consumption of only 0.1 watt.

If the contact is used for controlling switching devices which do not perform zero passage switching themselves, (N) should not be connected because the additional closing delay otherwise causes the opposite effect.

Either universal control voltage 12 to 230 V UC at the control input +A1/A2
or 230 V with glow lamp current up to 5 mA at the control input (L)-A2 (N).
The simultaneous use of two potentials at the control inputs is not permitted.

Very low switching noise.

No permanent power supply necessary, therefore no standby loss.

State-of-the-art hybrid technology combines advantages of nonwearing electronic control with high capacity of special relays.

By using a bistable relay coil power loss and heating is avoided even in the on mode.

The relay contact can be open or closed when putting into operation. It will be synchronised at first operation.

Same terminal connection as the electromechanical impulse switch S12-100-.

If this impulse switch is in a circuit, which is monitored by a FR12-230V mains disconnection relay, no additional base load is required. However, the monitoring voltage of the FR12-230V must be set to 'max'. Control only through A1-A2.

Typical connections

Either universal control voltage 12 to 230 V UC

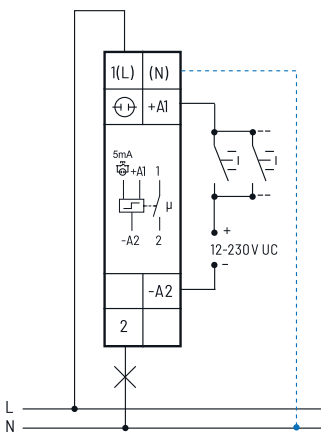

or control voltage 230 V with glow lamp current up to 5 mA

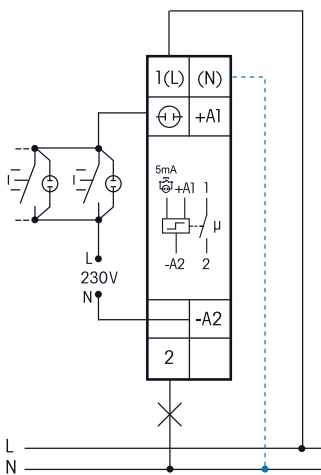

If N is connected, the zero passage switching is active.

The electronics does not have an internal power supply and therefore no power is consumed in any contact position. A control current flows only during a short control impulse of 0.2 seconds. This activates the microcontroller, reads the last switching state from the non-voltage memory, switches the bistable relay to its opposite state accordingly and rewrites the new switching state to memory.

ES12DX-UC	Impulse switch, 1 NO contact 16 A	Art. No. 21100002	56,90 €/pc.
-----------	-----------------------------------	-------------------	-------------

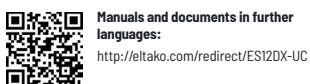

Manuals and documents in further languages:
<http://eltako.com/redirect/ES12DX-UC>

Technical data page 11-15.
Housing for operating instructions
GBA14 page 1-49 chapter 1.

IMPULSE SWITCH WITH TUNGSTEN PRE-CONTACT ESW12DX-UC



Typical connections

with zero passage switching

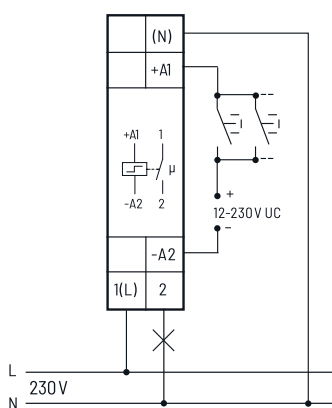

without zero passage switching

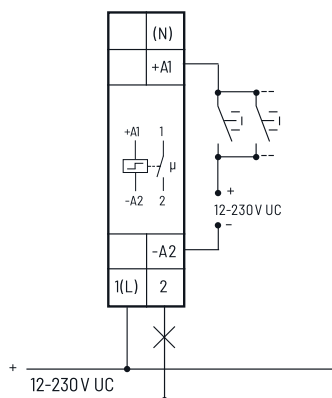

Manuals and documents in further languages:
<http://eltako.com/redirect/ESW12DX-UC>

Technical data page 11-15.
 Housing for operating instructions
 GBA14 page 1-49 chapter 1.

ESW12DX-UC



1 NO contact potential free 16 A/250 V AC with tungsten pre-contact. The pre-run contact closes before the main contact and thus handles inrush current from LED lamps that occurs over a few ms. Max. inrush current 500 A/2 ms. No standby loss.

Modular device for DIN-EN 60715 TH35 rail mounting.

1 module = 18 mm wide, 58 mm deep.

State-of-the-art hybrid technology combines advantages of nonwearing electronic control with high capacity of special relays.

With the patented Eltako Duplex technology (DX) the normally potential-free contacts can still switch in zero passage when switching 230 V AC 50 Hz and therefore drastically reduce wear. Simply connect the neutral conductor to the terminal (N) and L to 1(L) for this. This gives a standby consumption of only 0.1 Watt.

Universal control voltage 12 to 230 V UC.

Low switching noise.

No permanent power supply necessary, therefore no standby loss.

By using a bistable relay coil power loss and heating are avoided even in the on mode.

The relay contact can be open or closed during start-up. It is synchronised at first operation.

The electronics does not have an internal power supply and therefore no power is consumed in any contact position. A control current flows only during a short control impulse of 0.2 seconds. This activates the microcontroller, reads the last switching state from the non-voltage memory, switches the bistable relay to its opposite state accordingly and rewrites the new switching state to memory.

ESW12DX-UC	Impulse switch with tungsten pre-contact, 1 NO contact 16 A	Art. No. 21100801	57,20 €/pc.
-------------------	--	--------------------------	--------------------

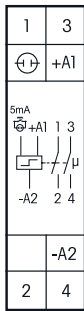

ES12-200-UC



2 NO contacts potential free 16 A/250 V AC. 230 V LED lamps up to 200 W, incandescent lamp load up to 2000 W. No standby loss.

Modular device for DIN-EN 60715 TH35 rail mounting.
1 module = 18 mm wide, 58 mm deep.

Either universal control voltage 12 to 230 V UC at the control input +A1/A2
or 230V with glow lamp current up to 5 mA at the control input \ominus (L)/-A2(N).
The simultaneous use of two potentials at the control inputs is not permitted.
Very low switching noise.

No permanent power supply necessary, therefore no standby loss.

State-of-the-art hybrid technology combines advantages of nonwearing electronic control with high capacity of special relays.

By using a bistable relay coil power loss and heating is avoided even in the on mode.

The relay contact can be open or closed when putting into operation. It will be synchronised at first operation.

Same terminal connection as the electromechanical impulse switch S12-200-.

Maximum current across both contacts 16 A for 230 V.

If this impulse switch is in a circuit, which is monitored by a FR12-230V mains disconnection relay, no additional base load is required. However, the monitoring voltage of the FR12-230V must be set to 'max'.

The electronics does not have an internal power supply and therefore no power is consumed in any contact position. A control current flows only during a short control impulse of 0.2 seconds. This activates the microcontroller, reads the last switching state from the non-voltage memory, switches the bistable relay to its opposite state accordingly and rewrites the new switching state to memory

Typical connections

Either universal control voltage 12 to 230 V UC

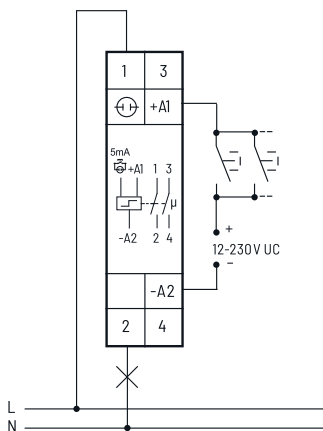

or control voltage 230 V with glow lamp current up to 5 mA

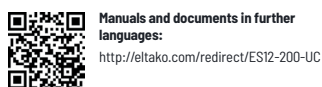
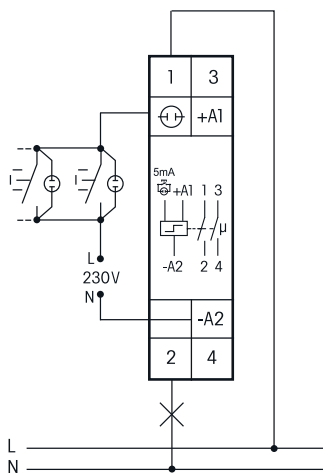

Technical data page 11-15.
Housing for operating instructions
GBA14 page 1-49 chapter 1.

ES12-200-UC	Impulse switch, 2 NO contacts 16 A	Art. No. 21200002	59,10 €/pc.
--------------------	------------------------------------	--------------------------	--------------------

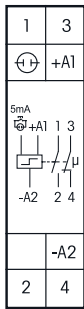

ES12-110-UC



1 NO contact + 1 NC contact potential free 16 A/250 V AC. 230 V LED lamps up to 200 W, incandescent lamp load up to 2000 W. No standby loss.

Modular device for DIN-EN 60715 TH35 rail mounting.
1 module = 18 mm wide, 58 mm deep.

Either universal control voltage 12 to 230 V UC at the control input +A1/A2
or 230V with glow lamp current up to 5 mA at the control input \oplus (L)/-A2(N).
The simultaneous use of two potentials at the control inputs is not permitted.
Very low switching noise.

No permanent power supply necessary, therefore no standby loss.

State-of-the-art hybrid technology combines advantages of nonwearing electronic control with high capacity of special relays.

By using a bistable relay coil power loss and heating is avoided even in the on mode.

The relay contact can be open or closed when putting into operation. It will be synchronised at first operation.

Same terminal connection as the electromechanical impulse switch S12-110-.

If this impulse switch is in a circuit, which is monitored by a FR12-230V mains disconnection relay, no additional base load is required. However, the monitoring voltage of the FR12-230V must be set to 'max'.

The electronics does not have an internal power supply and therefore no power is consumed in any contact position. A control current flows only during a short control impulse of 0.2 seconds. This activates the microcontroller, reads the last switching state from the non-voltage memory, switches the bistable relay to its opposite state accordingly and rewrites the new switching state to memory.

Typical connections

Either universal control voltage 12 to 230 V UC

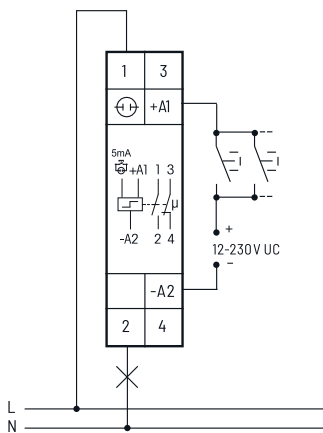

or control voltage 230 V with glow lamp current up to 5 mA

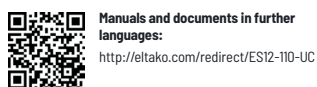
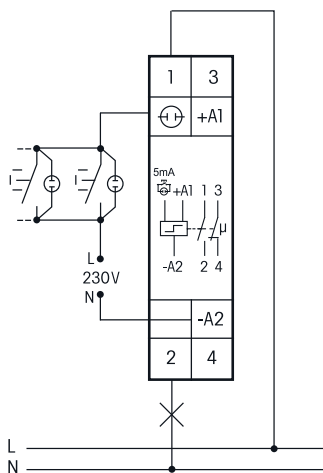

Manuals and documents in further languages:
<http://eltako.com/redirect/ES12-110-UC>

Technical data page 11-15.
Housing for operating instructions
GBA14 page 1-49 chapter 1.

ES12-110-UC	Impulse switch, 1 NO contact + 1 NC contact 16 A	Art. No. 21110002	58,20 €/pc.
-------------	--	-------------------	-------------

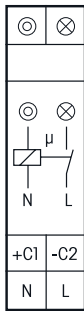

ESR12NP-230V+UC



1 NO contact not potential free 16 A/250 V AC. 230 V LED lamps up to 600 W, incandescent lamp load up to 2300 W. Off delay impulse switch with switch-off early warning and pushbutton permanent light switchable. Standby loss 0.5 watt only.

Modular device for DIN-EN 60715 TH35 rail mounting.
1 module = 18 mm wide, 58 mm deep.

Zero passage switching to protect contacts and lamps.

State-of-the-art hybrid technology combines advantages of nonwearing electronic control with high capacity of special relays.

Control voltage 230 V. In addition electrically isolated universal voltage from 8 to 230 V UC. Supply voltage and switching voltage 230 V.

Very low switching noise. If the function ESV is set, definitely variable off-delay time RV from 2 to 120 minutes, settable by minute scale.

Contact position indication with two LEDs. This starts blinking after 15 seconds in case of an inhibited pushbutton (not if the function ER is set).

Glow lamp current up to 150 mA only at the control input 230 V independent from ignition voltage (not if the function ER is set).

Relays with suitable functions to feed back the switching voltage signal of a dimmer switch.

In case of a power failure the system is disconnected in a preset sequence.

The functions ES, ESV or ER are selectable **by means of a rotary switch.**

ES = Impulse switch

ER = Switching relay

ESV = Impulse switch with off delay. The impulse switch automatically disconnects after the set delay is timed out if a manual OFF command has not been given. Infinitely variable time range up to 120 minutes.

ESV = If switch-off early warning \square is set the stairwell lighting starts flickering approximately + \square 30 seconds before timeout at repeated shorter time intervals. During this process reset is possible.

ESV = If pushbutton permanent light \odot is set permanent light can be switched on by pressing longer + \odot than 1 sec. This switches off automatically after 2 hours or by an operation longer than 2 seconds.

ESV = If both switch-off early warning function and permanent light by pushbutton set, the switch-off + $\square \odot$ early warning function is activated before switching off the permanent light.

If this impulse switch with integrated relay function is in a circuit, which is monitored by a FR12-230V mains disconnection relay, no additional base load is required. However, the monitoring voltage of the FR12-230V must be set to 'max'.

Function rotary switches

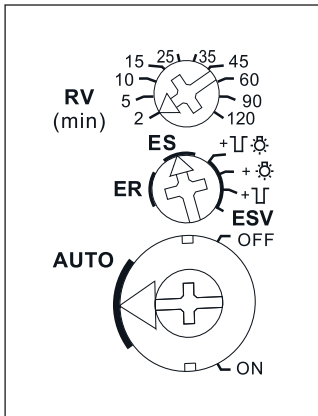

Standard setting ex works.

- \square = switch-off early warning
- \odot = pushbutton permanent light
- $\square \odot$ = switch-off early warning and pushbutton permanent light

Typical connection

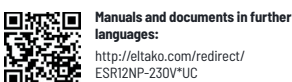
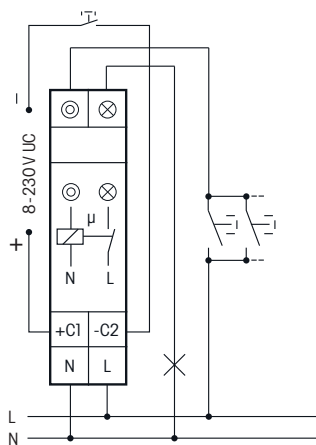

Manuals and documents in further languages:
http://eltako.com/redirect/ESR12NP-230V*UC

Technical data page 11-15.
Housing for operating instructions
GBA14 page 1-49 chapter 1.

ESR12NP-230V+UC	Impulse switch with integrated relay function, 1 NO contact 16 A	Art. No. 21100102	61,10 €/pc.
------------------------	--	--------------------------	--------------------

DIGITAL SETTABLE MULTIFUNCTION IMPULSE SWITCH WITH INTEGRATED RELAY FUNCTION ESR12DDX-UC

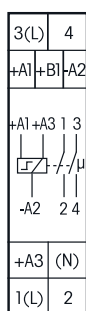

Typical connection

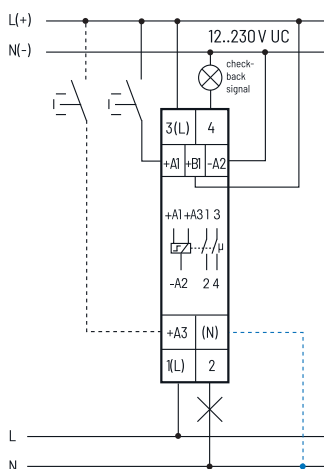

If N is connected, the zero passage switching is active.



Manuals and documents in further languages:
<http://eltako.com/redirect/ESR12DDX-UC>

Technical data page 11-15.
Housing for operating instructions
GBA14 page 1-49 chapter 1.

ESR12DDX-UC



1+1 NO contacts potential free 16 A/250 V AC. 230 V LED lamps up to 600 W, incandescent lamp load up to 2000 W. Standby loss 0.03-0.4 watt only.

Modular device for DIN-EN 60715 TH35 rail mounting. 1 module = 18 mm wide, 58 mm deep.

With the patented Eltako Duplex technology (DX) the normally potential-free contacts can still switch in zero passage when switching 230 V AC 50 Hz and therefore drastically reduce wear. Simply connect the neutral conductor to the terminal (N) and L to 1(L) and/or 3(L) for this. This results in an additional standby consumption of only 0.1 Watt.

Universal control voltage 12 to 230 V UC. Supply voltage is same as the control voltage.

The functions are set with the keys MODE and SET as described in the operating instructions. They are indicated on the display and can be blocked if required.

The accrued switch-on time is continuously displayed. First in hours (h), then in months (m) with 1 digit after the decimal point.

By using bistable relays coil power loss and heating is avoided even in the on mode.

The switched consumer may not be connected to the mains before the short automatic synchronisation after installation has terminated.

Only impulse switch functions: After a power failure the system is disconnected in a definite sequence or the switch position is kept depending on the setting (then + on the display next to function abbreviations). Settings under RSM in the menu guidance. Furthermore, when using these functions, with the keys MODE and SET, the control inputs A1 and A3 can be defined as central control inputs.

ZA1 = 'central off' with A1, local with A3; **ZE1** = 'central on' with A1, local with A3;

Z00 = no central control. 'Central on' with A1, 'central off' with A3. No local control refer to function RS.

Relays with suitable functions to feed back the switching voltage signal of a dimmer switch.

From 110V control voltage and in the settings 2S, WS, SS and GS glow lamp current up to 5mA, dependent on the ignition voltage.

With the keys MODE and SET you can select amongst 18 functions:

- OFF** = Permanent OFF
- 2xS** = 2-fold impulse switch with 1 NO contact each, control inputs A1 and A3
- 2S** = Impulse switch with 2 NO contacts
- WS** = Impulse switch with 1 NO contact and 1 NC contact
- SS1** = Impulse multi circuit switch 1+1 NO contacts for switching sequence
0 - contact 1(1-2) - contact 2(3-4) - contacts 1+2
- SS2** = Impulse multi circuit switch 1+1 NO contacts for switching sequence
0 - contact 1 - contacts 1+2 - contact 2
- SS3** = Impulse multi circuit switch 1+1 NO contacts for switching sequence 0 - contact 1 - contacts 1+2
- GS** = Impulse group switch 1+1 NO contacts for switching sequence 0 - contact 1 - 0 - contact 2
- RS** = Switch with 2 NO contacts, with A1 = set control input and A3 = reset control input
- 2xR** = 2-fold switching relay with 1 NO contact each, control inputs A1 and A3
- 2R** = Switching relay with 2 NO contacts
- WR** = Switching relay with 1 NO contact and 1 NC contact
- RR** = Switching relay (closed-circuit current relay) with 2 NC contacts
- EAW** = Impulse relay for fleeting NO contact and fleeting NC contact with 1+1 NO contacts, wiping time 1 sec each
- EW** = Impulse relay for fleeting NO contact with 1 NO contact and 1 NC contact, wiping time 1 sec
- AW** = Impulse relay fleeting NC contact with 1 NO contact and 1 NC contact, wiping time 1 sec
- GR** = Group relay 1+1 NO contacts (relay with alternating closing contacts)
- ON** = Permanent ON

The control inputs A1 and A3 have the same functions except for 2xS, 2xR and RS, if not used as central control inputs.

After setting the required function, the function can be blocked.

An arrow on the right of the abbreviation indicates the blocking status.

ESR12DDX-UC	Multifunction impulse switch with integrated relay function, 1+1 NO contacts 16 A	Art. No. 21200302	76,10 €/pc.
--------------------	---	--------------------------	--------------------

IMPULSE SWITCH WITH POTENTIAL FREE CONTACTS ES12Z, ALSO FOR CENTRAL CONTROL

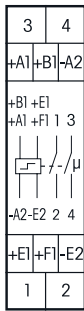

Function rotary switches

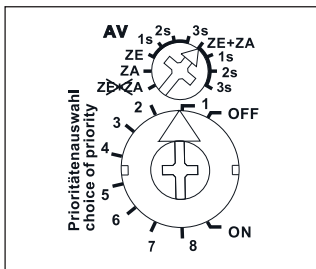

Standard setting ex works.

Typical connection

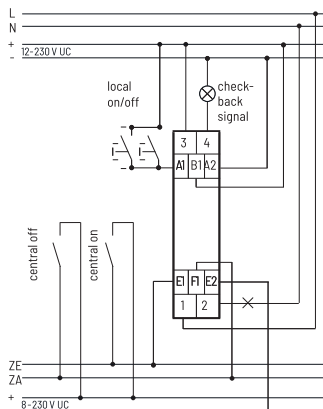

Manuals and documents in further languages:
<http://eltako.com/redirect/ES12Z-200-UC>



Manuals and documents in further languages:
<http://eltako.com/redirect/ES12Z-110-UC>

Technical data page 11-15.
Housing for operating instructions
GBA14 page 1-49 chapter 1.

Recommended retail prices excluding VAT.

ES12Z-200-UC



2 NO contacts potential free 16 A/250 V AC. 230 V LED lamps up to 200 W, incandescent lamp load up to 2000 W. Standby loss 0.03-0.4 watt only. Central control priorities selectable.

Modular device for DIN-EN 60715 TH35 rail mounting. 1 module = 18 mm wide, 58 mm deep.

State-of-the-art hybrid technology combines advantages of nonwearing electronic control with high capacity of special relays.

Local universal control voltage 12 to 230 V UC.

In addition control inputs 8 to 230 V UC central ON and central OFF, electrically isolated from the local input.

Supply voltage same as the local control voltage. Very low switching noise. Glow lamp current starting at 110 V control voltage up to 50 mA in positions 1 to 3 and 5 to 7 of the rotary switch.

By using a bistable relay coil power loss and heating is avoided even in the on mode.

The switched consumer may not be connected to the mains before the short automatic synchronisation after installation has terminated.

Maximum current across both contacts 16 A for 230 V. Contact position indication with LED. This starts blinking after 15 seconds in case of an inhibited pushbutton, not in position 4+8 of the rotary switch.

With the upper rotary switch this impulse switch can be partly or completely excluded from central control:

ZE+ZA = 'Central ON' and 'Central OFF' are active. You can select a response delay of 0, 1, 2 or 3 seconds for 'Central ON'. **ZE** = Only 'Central ON' is active. You can select a response delay of 0, 1, 2 or 3 seconds. **ZA** = Only 'Central OFF' is active. **ZE+ZA** = No central control is active.

The lower rotary switch sets several priorities. These determine which other control inputs are inhibited as long as another control input is excited permanently.

Furthermore, here it is decided if the switch position should be kept or not after a power failure:

In positions 1 to 4 of the rotary switch the switch position remains unchanged, in positions 5 to 8 it is switched off. Incoming central commands are executed immediately after the powersupply returns.

OFF = Permanent OFF, **ON** = Permanent ON

1 and 5 = No priority. Also if central control inputs are excited permanently, it is possible to operate the device by pushing a local push-button. The last central command is executed. This is the setting ex factory.

2 and 6 = Priority for central ON and OFF. Local push-buttons are temporarily inhibited. However, continuous excitation central OFF has priority over continuous excitation central ON.

3 and 7 = Priority for central ON and OFF. Local push-buttons are temporarily inhibited. However, continuous excitation central ON has priority over continuous excitation central OFF.

4 and 8 = Priority for permanently excited local push-button. In the meantime central commands are not executed. In these positions a glow lamp current is not permitted.

ES12Z-200-UC	Impulse switch, 2 NO contacts 16 A	Art. No. 21200601	68,20 €/pc.
--------------	------------------------------------	-------------------	-------------

ES12Z-110-UC



1 NO contact + 1 NC contact potential free 16 A/250 V AC. 230 V LED lamps up to 200 W, incandescent lamp load up to 2000 W. Standby loss 0.03-0.4 watt only. Central control priorities selectable.

All functions same as ES12Z-200, but with 1 NO contact and 1 NC contact.

ES12Z-110-UC	Impulse switch, 1 NO contact + 1 NC contact 16 A	Art. No. 21110601	68,20 €/pc.
--------------	--	-------------------	-------------

4-FOLD IMPULSE SWITCH WITH INTEGRATED RELAY FUNCTION ESR12Z-4DX-UC, ALSO FOR CENTRAL CONTROL AND GROUP CONTROL

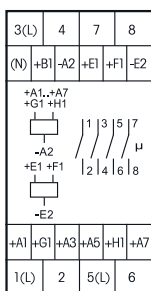

ESR12Z-4DX-UC



With 4 independent contacts, 1NO contact each potential free 16 A/250 V AC. 230 V LED lamps up to 600 W, incandescent lamp load up to 2000 W. Standby loss 0.03-0.4 watt only.

Modular devices for DIN-EN 60715 TH35 rail mounting. 2 modules = 36 mm wide, 58 mm deep.

Patented Eltako Duplex technology (DX) allows you to switch 3 of the 4 normally potential free contacts in zero passage switching when 230 V A/C voltage 50 Hz is switched. This drastically reduces wear. To achieve this, simply connect the N conductor to the terminal (N) and the phase conductors to 1(L), 3(L) or 5(L). This results in an additional standby consumption of only 0.1 watt. If the channels are used to control switchgear that has no zero passage switching, (N) should not be connected, otherwise the additional off-delay would have the opposite effect.

Local universal control voltage 12 to 230 V UC. In addition universal control inputs central ON and central OFF for 8 to 230V UC, electrically isolated from the local inputs.

With additional group control inputs ON and OFF for 12..230V UC. Same potential like the local control inputs. Groups of these impulse switches can be controlled separately using the group control inputs. Supply voltage like the local control voltage. **By using a bistable relay coil power loss and heating is avoided even in the on mode.** The switched consumers may not be connected to the mains before the short automatic synchronisation after installation has terminated. Central commands always have priority, local control inputs are blocked as long as central commands are activated. In case of a power failure the system is disconnected in a defined mode.

With the upper rotary switch this impulse switch with integrated relay function can be partly or completely excluded from central control: ZE+ZA = central ON and central OFF, ZE = central ON only, ZA = central OFF only ~~ZE+ZA~~, = no central control.

Use the middle rotary switch to preselect the functions of the lower rotary switch for ES and ER. Use ER to select the clamp functions. If BM is selected, control can be exerted by a motion detector. **Not suitable to feed back the switching voltage signal of a dimmer switch. Use only relays ESR12DDX-UC, ESR12NP-230V+UC or ESR61NP-230V+UC for this purpose. With the lower rotary switch 18 different functions may be selected:**

Function rotary switches

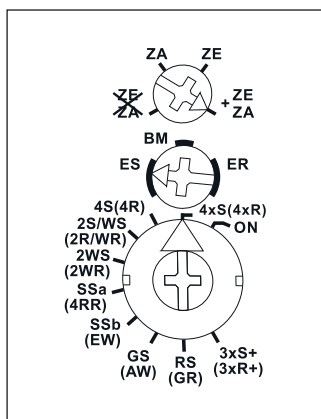

Standard setting ex works.

Typical circuit with central control and group control

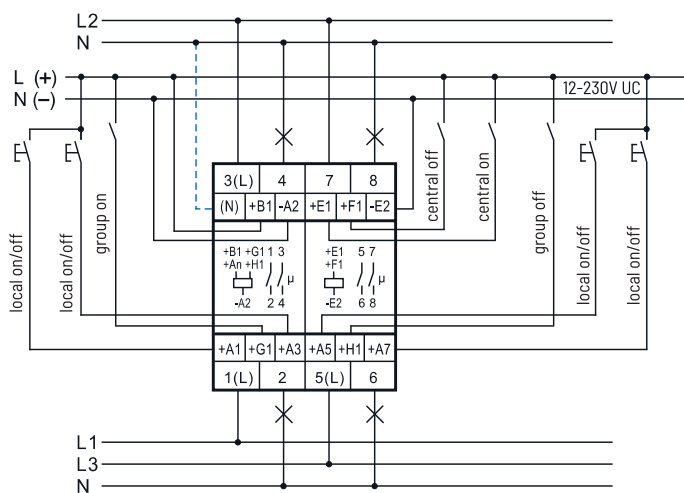

If N is connected, the zero passage switching is active at the contacts 1-2, 3-4 and 5-6.

- ON** = Permanent ON
- 4xS** = 4-fold impulse switch with 1 NO contact each, control inputs A1, A3, A5 and A7
- (4xR)** = 4-fold switching relay with 1 NO contact each, control inputs A1, A3, A5 and A7
- 4S** = Impulse switch with 4 NO contacts
- (4R)** = Switching relay with 4 NO contacts
- 2S/WS** = Impulse switch with 3 NO contacts and 1 NC contact
- (2R/WR)** = Switching relay with 3 NO contacts and 1 NC contact
- 2WS** = Impulse switch with 2 NO contacts and 2 NC contacts
- (2WR)** = Switching relay with 2 NO contacts and 2 NC contacts
- SSa** = Impulse multi circuit switch 2+2 NO contacts for switching sequence 0-2-2+4-2+4+6; check back signal 8
- (4RR)** = closed-circuit current relay with 4 NC contacts
- SSb** = Impulse multi circuit switch 2+2 NO contacts for switching sequence 0-2-2+4-2+4+6-2+4+6+8
- (EW)** = Impulse relay for fleeting NO contact with 3 NO contacts and 1 NC contact, wiping time 1 sec
- GS** = Impulse group switch. Switching sequence 0-2-0-4-0-6-0; check back signal 8
- (AW)** = Impulse relay fleeting NC contact with 3 NO contacts and 1 NC contact, wiping time 1 sec
- RS** = Switch with 4 NO contacts, A1 = set control input and A3 = reset control input
- (GR)** = Group relay 1+1+1 NO contacts
- 3xS+** = 3-fold impulse switch with 1 NO contact each + check back signal 8, control inputs A1, A3 and A5
- (3xR+)** = 3-fold switching relay with 1 NO contact each + check back signal 8, control inputs A1, A3 and A5

Manuals and documents in further languages:
<http://eltako.com/redirect/ESR12Z-4DX-UC>

Technical data page 11-15.
Housing for operating instructions
GBA14 page 1-49 chapter 1.

ESR12Z-4DX-UC	Impulse Switch with integrated relay function, 4 x 1 NO contact 16 A	Art. No. 21400301	106,70 €/pc.
----------------------	--	--------------------------	---------------------

IMPULSE SWITCH ES61-UC AND IMPULSE SWITCH ES75-12..24V UC FOR INSTALLATION IN LIGHTING FITTINGS

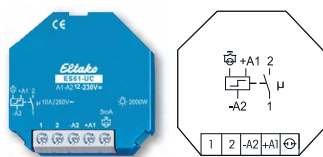

Typical connection

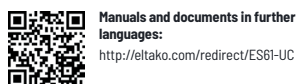
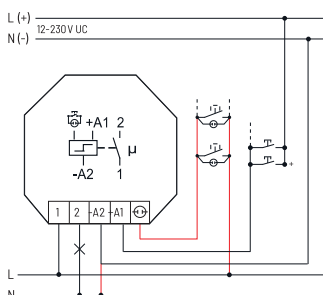

Technical data page 11-15.

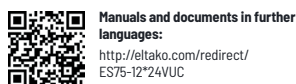
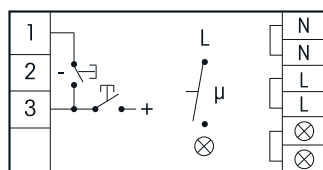
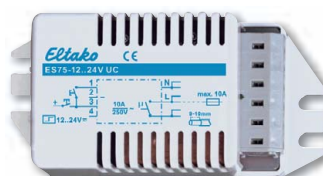

ES61-UC



1 NO contact potential free 10 A/250 V AC. 230 V LED lamps up to 200 W, incandescent lamp load up to 2000 W. No standby loss.

For installation. 45 mm long, 45 mm wide, 18 mm deep.

State-of-the-art hybrid technology combines advantages of nonwearing electronic control with high capacity of special relays.

Either universal control voltage 12 to 230 V UC at the control input +A1/-A2

or 230 V with a glow lamp current up to 5 mA at the control input $\ominus(L)/-A2(N)$.

Using two potentials simultaneously at the control inputs is not permitted.

Very low switching noise.

No permanent power supply necessary, therefore no standby loss.

By using a bistable relay coil power loss and heating is avoided even in the on mode.

The relay contact can be open or closed when putting into operation. It will be synchronised at first operation.

If this impulse switch is in a circuit, which is monitored by a FR12-230V mains disconnection relay, no additional base load is required. However, the monitoring voltage of the FR12-230V must be set to 'max'.

The electronics does not have an internal power supply and therefore no power is consumed in any contact position. A control current flows only during a short control impulse of 0.2 seconds. This activates the microcontroller, reads the last switching state from the non-voltage memory, switches the bistable relay to its opposite state accordingly and rewrites the new switching state to memory.

ES61-UC	Impulse switch, 1 NO contact 10 A	Art. No. 61100501	57,90 €/pc.
---------	-----------------------------------	-------------------	-------------

ES75-12..24V UC



For installation in lighting fittings. 1 NO contact not potential free 10 A/250 V AC. 230 V LED lamps up to 200 W, incandescent lamp load up to 500 W. Standby loss 1 watt only.

Built-in device for installation. 85 mm long, 40 mm wide, 28 mm deep.

With integrated transformer to galvanically separate the control circuit from the switching circuit to comply with the requirements for safety extra low voltage (SELV) to EN 60669-2-2. As of production week 18/18, compliance is fulfilled with the safety requirements of 2x MOPP to EN 60601-1. Activation by internal voltage or external control voltage of 12 to 24 V UC, control current 10 mA at 24 V. Continuous power supply 230 V. A circuit breaker of max. 10 A is required.

Incandescent lamps and halogen lamps load up to 500 W¹⁾ and fluorescent lamps with conventional ballast units in lead-lag circuit up to 1000 VA. Fluorescent lamps with conventional ballast units parallel compensated 300 VA.

Temperatures at the mounting location between -20°C and +50°C.

Min. command pulse duration/command pause 20/300 ms.

Connections on the low voltage side: 4-pole pin receptacle for STOCK0 MKF 13264-6-0-404 plug, 230 V connections: 6-pole terminal strip with plug-in terminals. max. conductor cross section 2.5 mm². One STOCK0 plug comes with each device.

¹⁾ For lamps with 150 W max.

ES75-12..24VUC	Impulse switch for installation in lighting fittings, 1 NO contact 10 A	Art. No. 60100055	61,00 €/pc.
----------------	---	-------------------	-------------

IMPULSE SWITCH WITH INTEGRATED RELAY FUNCTION ESR61NP-230V+UC

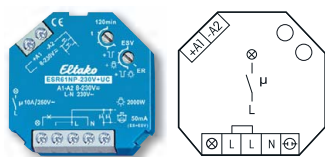

Function rotary switches

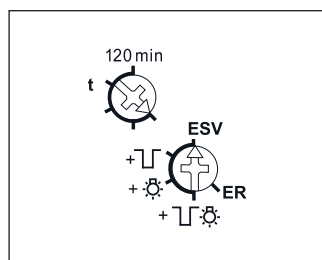

Standard setting ex works.

Typical connection

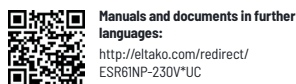
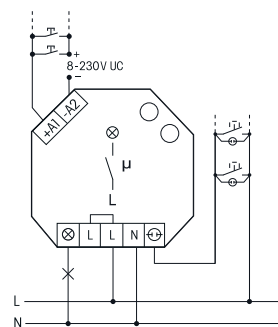

Technical data page 11-15.

ESR61NP-230V+UC



1 NO contact not potential free 10 A/250 V AC. 230 V LED lamps up to 600 W, incandescent lamp load up to 2000 W. Off delay impulse switch with switch-off early warning and pushbutton permanent light switchable. Standby loss 0.7 watt only.

For installation. 45 mm long, 45 mm wide, 18 mm deep.

Zero passage switching to protect contacts and lamps.

State-of-the-art hybrid technology combines advantages of nonwearing electronic control with high capacity of special relays.

By using a bistable relay coil power loss and heating is avoided even in the on mode.

The switched consumer may not be connected to the mains before the short automatic synchronisation after installation has terminated.

Control voltage 230V. In addition electrically isolated universal control voltage from 8 to 230 V UC. Supply voltage and switching voltage 230 V. Very low switching noise. Variable time range up to 120 minutes in the function ESV. At the control input pushbuttons with a glow lamp current up to 50 mA can be connected.

In case of a power failure the system is disconnected in a preset sequence.

If the timing period is set to minimum in the function ESV, the release delay is switched off. The standard impulse switch function ES is then set. The function ER is selectable. If the function ER is selected a glow lamp current is not permitted. Only the control input A1-A2 should be used.

When set to the function ER this device is suitable to feed back the switching voltage signal of a dimmer switch.

If switch-off early warning function is switched on, the light starts flickering approx. 30 seconds before time-out. This is repeated three times at decreasing time intervals.

If the permanent light function is switched on, the function can be activated by pressing the pushbutton for longer than 1 second. This function switches off automatically after 2 hours or by pressing the pushbutton for longer than 2 seconds.

If both switch-off early warning function and permanent light by pushbutton are set, the switch-off early warning function is activated before switching off the permanent light.

ESR61NP-230V+UC	Impulse switch with integrated relay function, 1 NO contact 10 A	Art. No. 61100001	58,10 €/pc.
------------------------	--	--------------------------	--------------------

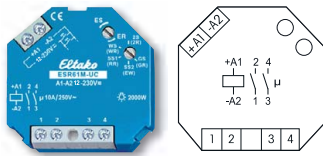

ESR61M-UC



1+1 NO contacts potential free 10 A/250 V AC. 230 V LED lamps up to 200 W, incandescent lamp load up to 2000 W. No standby loss.

Function rotary switches

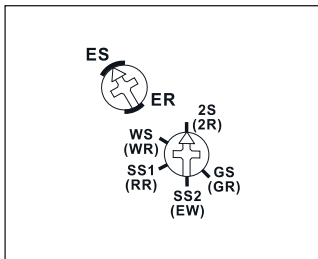

Standard setting ex works.

Typical connection

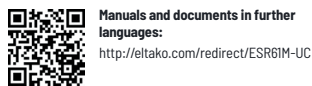
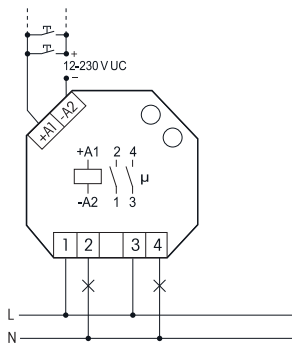

Technical data page 11-15.

For installation. 45 mm long, 45 mm wide, **32 mm deep.**

State-of-the-art hybrid technology combines advantages of nonwearing electronic control with high capacity of special relays.

Universal control voltage 12 to 230 V UC.

No permanent power supply necessary, therefore no standby loss.

By using bistable relays coil power loss and heating is avoided even in the on mode.

The switched consumer may not be connected to the mains before the short automatic synchronisation after installation has terminated.

The functions of the second rotary switch are preselected using the rotary switch ES/ER.

The setting ER selects the function in brackets. 10 different functions are selectable.

2S = Impulse switch with 2 NO contacts

(2R) = Switching relay with 2 NO contacts

WS = Impulse switch with 1 NO contact and 1 NC contact

(WR) = Switching relay with 1 NO contact and 1 NC contact

SS1 = Impulse multi circuit switch 1+1 NO contacts for switching sequence
 0 - contact 1(1-2) - contact 2(3-4) - contacts 1+2

(RR) = Switching relay (closed-circuit current relay) with 2 NC contacts

SS2 = Impulse multi circuit switch 1+1 NO contacts for switching sequence
 0 - contact 1 - contacts 1+2 - contact 2

(EW) = Impulse relay for fleeting NO contact with 1 NO contact and 1 NC contact, wiping time 1 sec

GS = Impulse group switch 1+1 NO contacts for switching sequence 0 - contact 1 - 0 - contact 2

(GR) = Group relay 1+1 NO contacts (relay with alternating closing contacts)

This relay is not suitable to feed back the switching voltage signal of a dimmer switch. Use only relays ESR12DDX-UC, ESR12NP-230V+UC or ESR61NP-230V+UC for this purpose.

The electronics does not have an internal power supply and therefore no power is consumed in any contact position. A control current flows only during a short control impulse of 0.2 seconds. This activates the microcontroller, reads the last switching state from the non-voltage memory, switches the bistable relay to its opposite state accordingly and rewrites the new switching state to memory.

ESR61M-UC	Multifunction impulse switch with integrated relay function, 1 + 1 NO contacts 10 A	Art. No. 61200301	71,90 €/pc.
------------------	---	--------------------------	--------------------

NOISELESS IMPULSE SWITCH WITH INTEGRATED RELAY FUNCTION WITH SOLID STATE RELAY ESR61SSR-230V

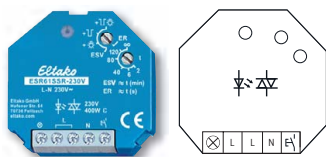

ESR61SSR-230V



Noiseless solid state relay not potential free. 230 V LED lamps up to 400 W, incandescent lamp load 400 W, off delay impulse switch with switch-off early warning and pushbutton permanent light switchable. Standby loss 0,3 watt only.

Function rotary switches

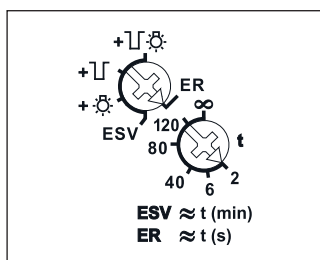

Standard setting ex works.

Typical connection

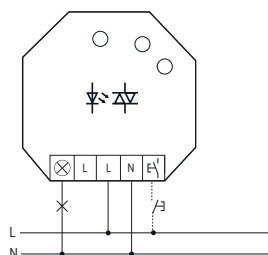

11-14

Manuals and documents in further languages:
<http://eltako.com/redirect/ESR61SSR-230V>

Technical data page 11-15.

For installation. 45 mm long, 45 mm wide, 18 mm deep.

Supply, switching and control voltage 230 V.

Zero passage switching.

In case of a power failure the system is disconnected in a preset sequence.

In the ER function the relay switches back on when the power is restored and the control input is active.

It is not permitted to apply a glow lamp current to the control input.

With automatic electronic overtemperature switch-off.

At a load of < 1W a GLE must be switched in parallel to the load.

Use the top rotary switch to select the required function of this impulse switch:

ER = switching relay

ESV = impulse switch. Possibly with off delay, then

+ = ESV with pushbutton permanent light

+ = ESV with switch-off early warning

+ = ESV with pushbutton permanent light and switch-off early warning

The LED flashes when the rotary switch reaches a new setting range to assist you to find the require position with certainty.

The LED lights up permanently when the relay is switched on.

When the pushbutton permanent light is switched on , set the LED to permanent light by pressing the pushbutton for longer than 1 second. This is indicated by the LED flickering briefly. After 2 hours, the permanent light switches off automatically or it can be switched off previously by briefly pressing the pushbutton.

If the switch-off early warning is switched on, the light starts to flicker approx. 30 seconds before time-out. This is repeated three times at decreasing time intervals.

During the switch-off early warning, the light can be switched back on by briefly pressing the pushbutton.

If both switch-off early warning and pushbutton permanent light are switched on, switch-off early warning is activated before automatic switch-off of the permanent light.

The function **ESV on the bottom rotary switch** sets the off delay from 2 to 120 minutes.

In setting ∞ normal impulse switch function ES without off delay, without pushbutton permanent light and without switch-off early warning.

In the ER function a switch-on wipe time can be set between 2 and 120 seconds. On expiry of the wipe time the relay switches off automatically.

In setting ∞ default relay function ER without wipe time.

ESR61SSR-230V	Noiseless impulse switch with integrated relay function with solid state relay	Art. No. 61100003	55,90 €/pc.
----------------------	--	--------------------------	--------------------

TECHNICAL DATA ELECTRONIC IMPULSE SWITCHES, ALSO FOR CENTRAL CONTROL



Type	ES12DX ^{a)} ESW12DX ^{a)} ES12-200 ^{a)} ES12-110 ^{a)}	ESR12NP	ESR12DDX ^{b)}	ES12Z ^{b)} ESR12Z-4DX ^{b)}	ES61 ^{a)} ESR61M ^{a)}	ESR61NP ^{b)}	ESR61SSR
Contacts							
Contact material/contact gap	AgSnO ₂ /0.5 mm	AgSnO ₂ /0.5 mm	AgSnO ₂ /0.5 mm	AgSnO ₂ /0.5 mm	AgSnO ₂ /0.5 mm	AgSnO ₂ /0.5 mm	Opto Triac
Spacing of control connections/contact control connections C1-C2 or A1-A2/contact	6 mm -	3 mm 6 mm	6 mm -	6 mm ESR12Z: 4 mm	3 mm ESR61M: 6 mm	3 mm 6 mm	- -
Test voltage contact/contact	ES12-200/110: 2000 V	-	2000 V	ES12Z: 4000 V ESR12Z: 2000 V	ESR61M: 2000 V	-	-
Test voltage control connection/contact	4000 V	2000 V	4000 V	4000 V	2000 V	2000 V	-
Test voltage C1-C2 or A1-A2/contact	-	4000 V	-	ESR12Z: 3000 V	ESR61M: 4000 V	4000 V	-
Rated switching capacity	16 A/250 V AC ⁵⁾	16 A/250 V AC	16 A/250 V AC	16 A/250 V AC ⁵⁾	10 A/250 V AC	10 A/250 V AC	-
230 V LED lamps	up to 200 W ⁷⁾ with DX up to 600 W ⁷⁾ I on ≤ 120 A/5 ms	up to 600 W ⁷⁾ I on ≤ 30 A/20 ms	up to 200 W ⁷⁾ with DX up to 600 W ⁷⁾ I on ≤ 120 A/5 ms	up to 200 W ⁷⁾ with DX up to 600 W ⁷⁾ I on ≤ 120 A/5 ms	up to 200 W ⁷⁾ I on ≤ 120 A/5 ms	up to 600 W ⁷⁾ I on ≤ 120 A/5 ms	up to 400 W ⁷⁾ I on ≤ 120 A/5 ms
Incandescent lamp and halogen lamp load ¹⁾ 230 V, I on ≤ 70 A/10 ms	2000 W ESW12DX: 3300 W ⁸⁾	2300 W	2000 W	2000 W	2000 W	2000 W	up to 400 W
Fluorescent lamp load with KVG* in lead-lag or non compensated	1000 VA	1000 VA	1000 VA	1000 VA	1000 VA	1000 VA	-
Fluorescent lamp load with KVG* shunt-compensated or with EVG*	500 VA	500 VA	500 VA	500 VA	500 VA	500 VA	up to 400 VA
Compact fluorescent lamps with EVG* and energy saving lamps ESL	I on ≤ 70 A/ 10 ms ²⁾ ES12DX: 15x7 W 10x20 W ³⁷⁾	15x7 W 10x20 W ⁷⁾	15x7 W 10x20 W ³⁷⁾	I on ≤ 70 A/ 10 ms ²⁾ ESR12Z-4DX: 15x7 W 10x20 W ³⁷⁾	I on ≤ 70 A/ 10 ms ²⁾	15x7 W 10x20 W ⁷⁾	up to 400 W ⁷⁾
Max. switching current DC1: 12 V/24 V DC	8 A	-	8 A	8 A	8 A	-	-
Life at rated load, cos φ = 1 resp. for incandescent lamps 1000 W at 100/h	>10 ⁵	>10 ⁵	>10 ⁵	>10 ⁵	>10 ⁵	>10 ⁵	-
Life at rated load, cos φ = 0.6 at 100/h	> 4x10 ⁴	> 4x10 ⁴	> 4x10 ⁴	> 4x10 ⁴	> 4x10 ⁴	> 4x10 ⁴	∞
Max. operating cycles	10 ⁵ /h	10 ³ /h	10 ³ /h	10 ³ /h	10 ³ /h	10 ³ /h	10 ³ /h
Maximum conductor cross-section (3-fold terminal)	6 mm ² (4 mm ²)	6 mm ² (4 mm ²)	6 mm ² (4 mm ²)	6 mm ² (4 mm ²)	4 mm ²	4 mm ²	4 mm ²
Two conductors of same cross-section (3-fold terminal)	2.5 mm ² (1.5 mm ²)	2.5 mm ² (1.5 mm ²)	2.5 mm ² (1.5 mm ²)	2.5 mm ² (1.5 mm ²)	1.5 mm ²	1.5 mm ²	1.5 mm ²
Screw head	slotted/crosshead, pozidriv					slotted/crosshead	
Type of enclosure/terminals	IP50/IP20	IP50/IP20	IP50/IP20	IP50/IP20	IP30/IP20	IP30/IP20	IP30/IP20
Electronics							
Time on (also for central on/off)	100%	100%	100%	100% ⁶⁾	100%	100%	100%
Max./min. temperature at mounting location	+50°C/-20°C	+50°C/-20°C	+50°C/-20°C	+50°C/-20°C	+50°C/-20°C	+50°C/-20°C	+50°C/-20°C
Standby loss (active power) 230 V	-	0.5 W	0.4 W	0.4 W	-	0.7 W	0.3 W
Standby loss (active power) 12 V ⁴⁾	-	-	0.03 W	0.03 W	-	-	-
Control current 230 V-control input local (<10 s)	-	10 mA	-	-	-	10 mA	1 mA
Control current universal control voltage all control voltages (<5 s) ± 20% 8/12/24/230 V (<10 s) ± 20%	1.5 mA (15 mA) ⊖ 30 (23) mA	- 2/4/9/5 (100) mA	- 2/3/7/3 (50) mA	- 0.1/0.1/0.2/1 (30) mA	1.5 mA (15 mA) ⊖ 30 (23) mA ESR61M: 4 mA	- 2/4/9/5 (100) mA	-
Control current central 8/12/24/230 V (<10 s) ± 20%	-	-	-	2/4/9/5 (100) mA	-	-	-
Max. parallel capacitance (approx. length) of single control lead at 230 V AC	⊖ 0.3 μF (1000 m) A1-A2: 0.06 μF (200 m)	ES: 0.3 μF (1000 m) ER: 3 nF (10 m) C1-C2: 15 nF (50 m)	0.3 μF (1000 m)	0.3 μF (1000 m)	⊖ : 0.3 μF (1000 m) A1-A2: 0.06 μF (200 m) ESR61M: 0.5 nF (2 m)	⊖ 0.06 μF (200 m) A1-A2: 0.3 μF (1000 m)	30 nF (100 m)
Max. parallel capacitance (approx. length) of central control lead at 230 V AC	-	-	-	0.9 μF (3000 m)	-	-	-

* EVG = electronic ballast units; KVG = conventional ballast units

¹⁾ Bistable relay as relay contact. The relay contact can be open or closed when putting into operation. It will be synchronised at first operation. ²⁾ Bistable relay as relay contact. The switched consumer may not be connected to the mains before the short automatic synchronisation after installation has terminated. ³⁾ For lamps with 150 W max. ⁴⁾ A 40-fold inrush current must be expected for electronic ballast devices. For steady loads of 1200 W or 600 W use the current-limiting relay SBR12 or SBR61. See chapter 14, page 14-8. ⁵⁾ When using DX types close attention must be paid that zero passage switching is activated! ⁶⁾ Standby loss at 24 V approx. two times greater than at 12 V. ⁷⁾ For ES12-200 and ES12Z-200 maximum current across both contacts 16 A for 230 V. ⁸⁾ Please consider sufficient ventilation at permanent connection of several impulse switches according to power loss calculation, and if necessary leave a ventilation distance of about 1/2 module. ⁹⁾ Usually applies for dimmable 230 V LED lamps and dimmable energy saving lamps. Due to different lamp electronics and depending on the manufacturer, the maximum number of lamps may be limited, especially if the wattage of the individual lamps is very low (e.g. with 2 W LEDs). ¹⁰⁾ Up to 2x10⁴ switching cycles at 1 s on & 9 s off.

To comply with DIN VDE 0100-443 and DIN VDE 0100-534, a Type 2 or Type 3 surge protection device (SPD) must be installed.

**ER12DX-UC
ESR12DDX-UC
ER61-UC**

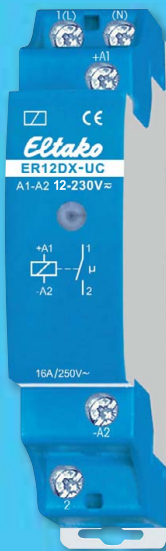

**SWITCHING AND CONTROL PROFESSIONALS –
ELECTRONIC SWITCHING RELAYS, CONTROL
RELAYS AND COUPLING RELAYS.**

Electronic switching relays, control relays and coupling relays







Selection table switching relays, control relays and coupling relays	12 - 2
Switching relay ER12DX-UC	12 - 3
Switching relay ER12-200-UC and ER12-110-UC	12 - 4
Switching and control relays ER12-001-UC and ER12-002-UC	12 - 5
Switching relay noiseless ER12SSR-UC with solid state relay	12 - 6
Impulse switch with integrated relay function ESR12NP-230V+UC	12 - 7
Digital settable multifunction impulse switch with integrated relay function ESR12DDX-UC	12 - 8
Coupling relays KR09-12V UC, KR09-24V UC and KR09-230V	12 - 9
Coupling relay KRW12DX-UC	12 - 10
Switching relay ER61-UC and impulse switch with integrated relay function ESR61NP-230V+UC	12 - 11
Multifunction impulse switch with integr. relay function ESR61M-UC	12 - 12
Noiseless impulse switch with integrated relay function ESR61SSR-230V with solid state relay	12 - 13
Isolating relays ETR61-230V and ETR61NP-230V	12 - 14
Isolating relay ETR61NP-230V with window contact FK and window contact FK	12 - 15
Technical data electronic switching relays, control relays and coupling relays	12 - 16

SELECTION TABLE SWITCHING RELAYS, CONTROL RELAYS AND COUPLING RELAYS

SWITCHING AND CONTROL PROFESSIONALS

Professional hybrid relays combine the advantages of nonwearing electronic control with high switching capacity of special relays. We also use mainly bistable relays. Thus preventing coil power loss

even in the on mode. This increases energy efficiency and reduces heating in the switch cabinet.

Page	12-3	12-4	12-4	12-5	12-5	12-6	12-7	12-8	12-9	12-10	12-11	12-11	12-12	12-13	12-14	12-14	12-15	
	pictograms	ERT2DX-UC	ERT2-200-UC	ERT2-110-UC	ERT2-001-UC	ERT2-002-UC	ERT2SSR-UC	ESR12NP-230V+UC	ESR12DDX-UC	KR09-12V UC, 24V UC, 230V	KRW12DX-UC	ER61-UC	ESR6INP-230V+UC	ESR6IM-UC	ESR6ISSR-230V	ETR61-230V	ETR6INP-230V	ETR6INP-230V+FK
Modular device for mounting on DIN rail EN 60715 TH35, number of modules 18 mm each	1	1	1	1	1	1	1	1	1/2	1								
Built-in device for installation (e.g. flush-mounting box)												■	■	■	■	■	■	■
Number NO contacts or changeover contact (W) potential free (not potential free)	1	2	1	1W	2W	1	(1)	1+1 ²⁾ 2 ²⁾	1	1	1W	(1)	1+1 ²⁾ 2 ²⁾	(1)	1	(1)	(1)	
Number NC contacts potential free			1					1-2 ²⁾				1-2 ²⁾						
Zero passage switching		■ ⁷⁾					■	■	■ ⁷⁾	■ ⁷⁾		■		■				
Switching capacity 16 A/250 V AC	■	■	■	■	■		■	■		■								
Switching capacity 10 A/250 V AC									6 A		■	■	■		■	■	■	
230 V LED lamps (W)	up to 600	up to 200	up to 200	up to 200	up to 200	up to 400	up to 600	up to 600	up to 50	up to 600	up to 200	up to 600	up to 200	up to 400	up to 50	up to 100	up to 100	
Incandescent lamp load (W)	2000	2000	2000	2000	2000	400	2300	2000	500	3300	2000	2000	2000	400	1000	2000	2000	
Bistable relay(s) as relay contact(s)		■ ⁵⁾	■ ⁵⁾	■ ⁵⁾	■ ⁵⁾	■ ⁵⁾		■ ⁶⁾		■ ⁵⁾	■ ⁵⁾	■ ⁶⁾	■ ⁵⁾					
Switchable between the functions for impulse switches and switching relays							■	■				■	■	■				
Universal control voltage		■	■	■	■	■	■	■		■	■	■	■					
(additional) control voltage 230 V							■	■				■		■				
Supply voltage same as control voltage								■						■				
Supply voltage 230 V							■ ³⁾					■		■	■	■	■	
No standby loss		■ ⁷⁾	■	■	■	■			■	■ ⁷⁾	■		■					
Low standby loss								■	■ ⁷⁾			■		■	■	■	■	
Glow lamp current (mA) at the control input 230 V							150 ¹⁾	5				50 ¹⁴⁾						

¹⁾ Glow lamp current independent from the ignition voltage.

²⁾ Depends on the set function.

³⁾ If the control voltage is 230 V, but the phase conductor is different from the 230 V supply voltage, the universal voltage control input must be used.

⁴⁾ At the control input .

⁵⁾ The relay contact can be open or closed when putting into operation. It will be synchronised at first operation.

⁶⁾ The switched consumer may not be connected to the mains before the short automatic synchronisation after installation has terminated.

⁷⁾ Patented duplex technology: When switching 230 V/50 Hz the contact switching takes place in the zero passage when L is connected to (L) and N to (N). The standby loss is then 0.1 Watt.



ER12DX-UC



1 NO contact potential free 16 A/250 V AC. 230 V LED lamps up to 600 W, incandescent lamp load 2000 W. No standby loss.

Modular device for DIN-EN 60715 TH35 rail mounting.

1 module = 18 mm wide, 58 mm deep.

State-of-the-art hybrid technology combines advantages of nonwearing electronic control with high capacity of special relays.

With the patented Eltako Duplex technology (DX) the normally potential-free contacts can still switch in zero passage when switching 230 V AC 50 Hz and therefore drastically reduce wear. Simply connect the neutral conductor to the terminal (N) and L to 1(L) for this. This gives an standby consumption of only 0.1 watt.

If the contact is used for controlling switching devices which do not perform zero passage switching themselves, (N) should not be connected because the additional closing delay otherwise causes the opposite effect.

Universal control voltage 12 to 230 V UC.

Very low switching noise.

Contact position indicator with LED.

Same terminal connection as electromechanical switching relay R12-100-.

By using a bistable relay coil power loss and heating is avoided even in the on mode.

The relay contact can be open or closed when putting into operation. It will be synchronised at first operation.

This relay is not suitable to feed back the switching voltage signal of a dimmer switch.

Use only relays ESR12DDX-UC, ESR12NP-230V+UC or ESR61NP-230V+UC for this purpose.

The electronics does not have an internal power supply and therefore no standby loss. The microcontroller is activated when the control contact closes. This switches the bistable relay to the correct direction. The bistable relay switches back either when the control contact opens or when the control voltage falls.

Typical connections

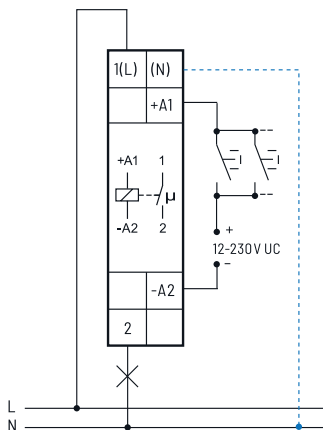

If N is connected, the zero passage switching is active.



Manuals and documents in further languages:
<http://eltako.com/redirect/ER12DX-UC>

Technical data page 12-16.
 Housing for operating instructions
 GBA14 page 1-49 chapter 1.

ER12DX-UC	Switching relay, 1 NO contact 16 A	Art. No. 22100002	56,30 €/pc.
-----------	------------------------------------	-------------------	-------------

SWITCHING RELAY ER12-200-UC AND ER12-110-UC

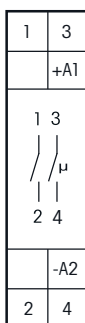

Manuals and documents in further languages:
<http://eltako.com/redirect/ER12-200-UC>

Technical data page 12-16.
 Housing for operating instructions
 GBA14 page 1-49 chapter 1.

ER12-200-UC



2 NO contacts potential free 16 A/250 V AC. 230 V LED lamps up to 200 W, incandescent lamp load 2000 W. No standby loss.

Modular device for DIN-EN 60715 TH35 rail mounting. 1 module = 18 mm wide, 58 mm deep.
 State-of-the-art hybrid technology combines advantages of nonwearing electronic control with high capacity of special relays.
 Universal control voltage 12 to 230 V UC.
 Very low switching noise.
 Contact position indicator with LED.

Maximum current across both contacts 16 A for 230 V.

Same terminal connection as electromechanical switching relay R12-200-.

By using a bistable relay coil power loss and heating is avoided even in the on mode.

The relay contact can be open or closed when putting into operation. It will be synchronised at first operation.

This relay is not suitable to feed back the switching voltage signal of a dimmer switch.

Use only relays ESR12DDX-UC, ESR12NP-230V+UC or ESR61NP-230V+UC for this purpose.

The electronics does not have an internal power supply and therefore no standby loss.
 The microcontroller is activated when the control contact closes. This switches the bistable relay to the correct direction. The bistable relay switches back either when the control contact opens or when the control voltage falls.

ER12-200-UC	Switching relay, 2 NO contacts 16 A	Art. No. 22200002	57,10 €/pc.
--------------------	-------------------------------------	--------------------------	--------------------

ER12-110-UC



1 NO + 1 NC contact potential free 16 A/250 V AC. 230 V LED lamps up to 200 W, incandescent lamp load 2000 W. No standby loss.

Modular device for DIN-EN 60715 TH35 rail mounting. 1 module = 18 mm wide, 58 mm deep.
 State-of-the-art hybrid technology combines advantages of nonwearing electronic control with high capacity of special relays.
 Universal control voltage 12 to 230 V UC.
 Very low switching noise.
 Contact position indicator with LED.

Same terminal connection as electromechanical switching relay R12-110-.

By using a bistable relay coil power loss and heating is avoided even in the on mode.

The relay contact can be open or closed when putting into operation. It will be synchronised at first operation.

This relay is not suitable to feed back the switching voltage signal of a dimmer switch.

Use only relays ESR12DDX-UC, ESR12NP-230V+UC or ESR61NP-230V+UC for this purpose.

The electronics does not have an internal power supply and therefore no standby loss.
 The microcontroller is activated when the control contact closes. This switches the bistable relay to the correct direction. The bistable relay switches back either when the control contact opens or when the control voltage falls.

ER12-110-UC	Switching relay, 1 NO contact + 1 NC contact 16 A	Art. No. 22110002	57,10 €/pc.
--------------------	---	--------------------------	--------------------

12-4

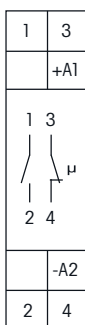

Manuals and documents in further languages:
<http://eltako.com/redirect/ER12-110-UC>

Technical data page 12-16.
 Housing for operating instructions
 GBA14 page 1-49 chapter 1.

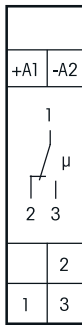

Manuals and documents in further languages:
<http://eltako.com/redirect/ER12-001-UC>

Technical data page 12-16.
 Housing for operating instructions
 GBA14 page 1-49 chapter 1.

ER12-001-UC



1 CO contact potential free 16 A/250 V AC. 230 V LED lamps up to 200 W, incandescent lamp load 2000 W. No standby loss.

Modular device for DIN-EN 60715 TH35 rail mounting. 1 module = 18 mm wide, 58 mm deep. State-of-the-art hybrid technology combines advantages of nonwearing electronic control with high capacity of special relays. Universal control voltage 12 to 230 V UC. Low control power demand, therefore substantially less heat is generated. Integrated free-wheeling anti-surge diode (A1 = +, A2 = -).

Safe disconnection to VDE 0106, Part 101; therefore, these devices can also be used as coupling relays. By using a bistable relay coil power loss and heating is avoided even in the on mode.

The relay contact can be open or closed when putting into operation. It will be synchronised at first operation.

This relay is not suitable to feed back the switching voltage signal of a dimmer switch. Use only relays ESR12DDX-UC, ESR12NP-230V+UC or ESR61NP-230V+UC for this purpose.

The electronics does not have an internal power supply and therefore no standby loss. The microcontroller is activated when the control contact closes. This switches the bistable relay to the correct direction. The bistable relay switches back either when the control contact opens or when the control voltage falls.

ER12-001-UC	Switching relay, 1 CO contact 16 A	Art. No. 22001601	55,70 €/pc.
-------------	------------------------------------	-------------------	-------------



Manuals and documents in further languages:
<http://eltako.com/redirect/ER12-002-UC>

Technical data page 12-16.
 Housing for operating instructions
 GBA14 page 1-49 chapter 1.

ER12-002-UC



2 CO contacts potential free 16 A/250 V AC. 230 V LED lamps up to 200 W, incandescent lamp load 2000 W. No standby loss.

Modular device for DIN-EN 60715 TH35 rail mounting. 1 module = 18 mm wide, 58 mm deep. State-of-the-art hybrid technology combines advantages of nonwearing electronic control with high capacity of special relays. Universal control voltage 12 to 230 V UC. Low switching noise. Contact position indicator with LED. Integrated free-wheeling anti-surge diode (A1 = +, A2 = -).

By using a bistable relay coil power loss and heating is avoided even in the on mode.

The relay contact can be open or closed when putting into operation. It will be synchronised at first operation.

This relay is not suitable to feed back the switching voltage signal of a dimmer switch. Use only relays ESR12DDX-UC, ESR12NP-230V+UC or ESR61NP-230V+UC for this purpose.

The electronics does not have an internal power supply and therefore no standby loss. The microcontroller is activated when the control contact closes. This switches the bistable relay to the correct direction. The bistable relay switches back either when the control contact opens or when the control voltage falls.

ER12-002-UC	Switching relay, 2 CO contacts 16 A	Art. No. 22002601	62,80 €/pc.
-------------	-------------------------------------	-------------------	-------------

SWITCHING RELAY NOISELESS WITH SOLIDE STATE RELAY ER12SSR-UC



ER12SSR-UC



Noiseless solid state relay not potential free, 230 V LED lamps up to 400 W, incandescent lamp load 400 W. No standby loss.

Modular device for DIN-EN 60715 TH35 rail mounting.

1 module = 18 mm wide, 58 mm deep.

Universal control voltage: 12 to 230 V UC, galvanically isolated from the switching voltage.

Contact position indication with LED.

Switching voltage 230 V AC.

Zero passage switching.

With automatic overtemperature shutdown.

With a load < 1W a GLE must be switched parallel to the load.

Typical connection

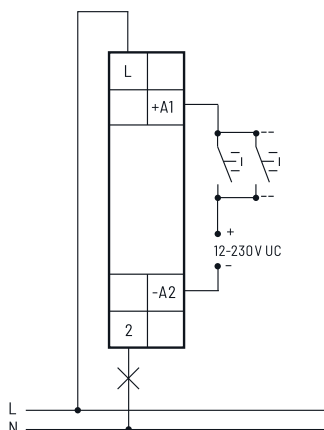

ER12SSR-UC	Switching relay noiseless with solide state relay	Art. No. 22100001	51,40 €/pc.
-------------------	---	--------------------------	--------------------



Manuals and documents in further languages:
<http://eltako.com/redirect/ER12SSR-UC>

12-6

Technical data page 12-16.
 Housing for operating instructions
 GBA14 page 1-49 chapter 1.

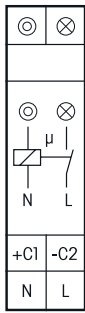

ESR12NP-230V+UC



1 NO contact not potential free 16 A/250 V AC. 230 V LED lamps up to 600 W, incandescent lamp load 2300 W. Off delay impulse switch with switch-off early warning and pushbutton permanent light switchable. Standby loss 0.5 watt only.

Modular device for DIN-EN 60715 TH35 rail mounting. 1 module = 18 mm wide, 58 mm deep.

Zero passage switching to protect contacts and lamps.

State-of-the-art hybrid technology combines advantages of nonwearing electronic control with high capacity of special relays.

Control voltage 230 V. In addition electrically isolated universal voltage from 8 to 230 V UC.

Supply voltage and switching voltage 230 V.

Very low switching noise. If the function ESV is set, definitely variable off-delay time RV from 2 to 120 minutes, settable by minute scale.

Contact position indication with two LEDs. This starts blinking in case of a blocked pushbutton (not if the function ER is set).

Glow lamp current up to 150 mA only at the control input 230 V independent from ignition voltage (not if the function ER is set).

Relays with suitable functions to feed back the switching voltage signal of a dimmer switch.

In case of a power failure the system is disconnected in a preset sequence.

The functions ES, ESV or ER are selectable **by means of a rotary switch.**

ES = Impulse switch

ER = Switching relay

ESV = Impulse switch with off delay. The impulse switch automatically disconnects after the set delay is timed out if a manual OFF command has not been given. Infinitely variable time range up to 120 minutes.

ESV = If switch-off early warning \sqcup is set the stairwell lighting starts flickering approximately 0 seconds + \sqcup before timeout at repeated shorter time intervals. During this process reset is possible.

ESV = If push-button permanent light \odot is set permanent light can be switched on by pressing longer than 1 sec. This switches off automatically after 2 hours or by an operation longer than 2 seconds.

ESV If both switch-off early warning function and permanent light by push-button $\sqcup \odot$ are set, the + $\sqcup \odot$ switch-off early warning function is activated before switching off the permanent light.

This electronic impulse switch does not need a base load for switching lights in rooms which are monitored by a FR12-230V mains disconnection relay.

Function rotary switches

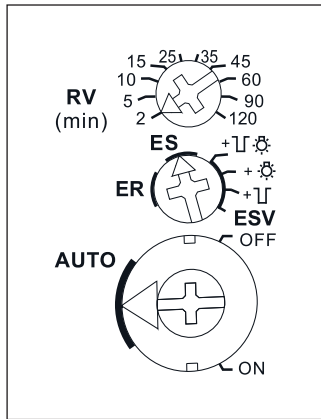

Standard setting ex works.

- \sqcup = switch-off early warning
- \odot = pushbutton permanent light
- $\sqcup \odot$ = switch-off early warning and pushbutton permanent light

Typical connection

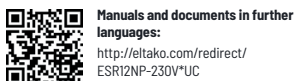
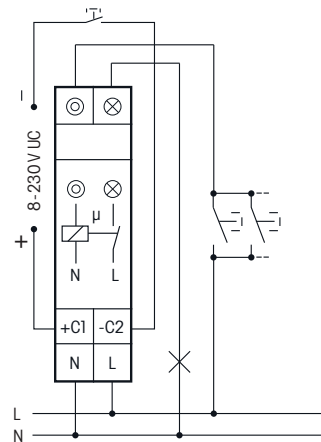

Manuals and documents in further languages:
http://eltako.com/redirect/ESR12NP-230V*UC

Technical data page 12-16.
 Housing for operating instructions
 GBA14 page 1-49 chapter 1.

Recommended retail prices excluding VAT.

ESR12NP-230V+UC	Impulse switch with integrated relay function, 1 NO contact 16 A	Art. No. 21100102	61,10 €/pc.
------------------------	--	--------------------------	--------------------

DIGITAL SETTABLE MULTIFUNCTION IMPULSE SWITCH WITH INTEGRATED RELAY FUNCTION ESR12DDX-UC



Typical connection

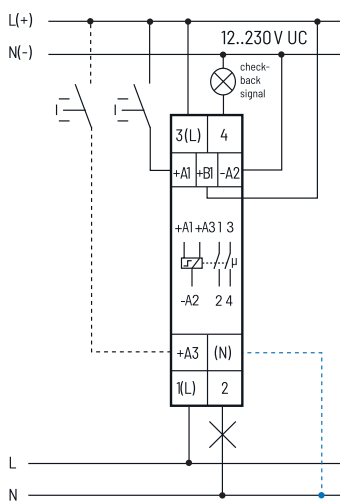

If N is connected, the zero passage switching is active.



Manuals and documents in further languages:
<http://eltako.com/redirect/ESR12DDX-UC>

Technical data page 12-16.
Housing for operating instructions
GBA14 page 1-49 chapter 1.

ESR12DDX-UC



1+1 NO contacts potential free 16 A/250 V AC. 230 V LED lamps up to 600 W, incandescent lamp load 2000 W. Standby loss 0.03-0.4 watt only.

Modular device for DIN-EN 60715 TH35 rail mounting. 1 module = 18 mm wide, 58 mm deep.

With the patented Eltako Duplex technology (DX) the normally potential-free contacts can still switch in zero passage when switching 230 V AC 50 Hz and therefore drastically reduce wear. Simply connect the neutral conductor to the terminal (N) and L to 1(L) and/or 3(L) for this. This results in an additional standby consumption of only 0.1 Watt.

Universal control voltage 12 to 230 V UC. Supply voltage is same as the control voltage.

The functions are set with the keys MODE and SET as described in the operating instructions. They are indicated on the display and can be blocked if required.

The accrued switch-on time is continuously displayed. First in hours (h), then in months (m) with 1 digit after the decimal point.

By using bistable relays coil power loss and heating is avoided even in the on mode.

The switched consumer may not be connected to the mains before the short automatic synchronisation after installation has terminated.

Only impulse switch functions: After a power failure the system is disconnected in a definite sequence or the switch position is kept depending on the setting (then + on the display next to function abbreviations). Settings under RSM in the menu guidance. Furthermore, when using these functions, with the keys MODE and SET, the control inputs A1 and A3 can be defined as central control inputs.

ZA1 = 'central off' with A1, local with A3; **ZE1** = 'central on' with A1, local with A3;

Z00 = no central control. 'Central on' with A1, 'central off' with A3. No local control refer to function RS.

Relays with suitable functions to feed back the switching voltage signal of a dimmer switch.

From 110V control voltage and in the settings 2S, WS, SS and GS glow lamp current up to 5 mA, dependent on the ignition voltage.

With the keys MODE and SET you can select amongst 18 functions:

- OFF** = Permanent OFF
- 2xS** = 2-fold impulse switch with 1 NO contact each, control inputs A1 and A3
- 2S** = Impulse switch with 2 NO contacts
- WS** = Impulse switch with 1 NO contact and 1 NC contact
- SS1** = Impulse multi circuit switch 1+1 NO contacts for switching sequence
0 - contact 1(1-2) - contact 2(3-4) - contacts 1 + 2
- SS2** = Impulse multi circuit switch 1+1 NO contacts for switching sequence
0 - contact 1 - contacts 1 + 2 - contact 2
- SS3** = Impulse multi circuit switch 1+1 NO contacts for switching sequence
0 - contact 1 - contacts 1 + 2
- GS** = Impulse group switch 1+1 NO contacts for switching sequence
0 - contact 1 - 0 - contact 2
- RS** = Switch with 2 NO contacts, with A1 = set control input and A3 = reset control input
- 2xR** = 2-fold switching relay with 1 NO contact each, control inputs A1 and A3
- 2R** = Switching relay with 2 NO contacts
- WR** = Switching relay with 1 NO contact and 1 NC contact
- RR** = Switching relay (closed-circuit current relay) with 2 NC contacts
- EAW** = Impulse relay for fleeting NO contact and fleeting NC contact with 1+1 NO contacts, wiping time 1 sec each
- EW** = Impulse relay for fleeting NO contact with 1 NO contact and 1 NC contact, wiping time 1 sec
- AW** = Impulse relay fleeting NC contact with 1 NO contact and 1 NC contact, wiping time 1 sec
- GR** = Group relay 1+1 NO contacts (relay with alternating closing contacts)
- ON** = Permanent ON

The control inputs A1 and A3 have the same functions except for 2xS, 2xR and RS, if not used as central control inputs.

After setting the required function, the function can be blocked. An arrow on the right of the abbreviation indicates the blocking status.

ESR12DDX-UC	Multifunction Impulse Switch with integrated relay function, 1+1 NO contacts 16 A	Art. No. 21200302	76,10 €/pc.
--------------------	---	--------------------------	--------------------

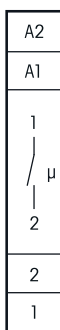

Manuals and documents in further languages:
<http://eltako.com/redirect/KR09-12V-UC>

Technical data page 12-16.
 Housing for operating instructions
 GBA14 page 1-49 chapter 1.

KR09-12V UC



1 NO contact potential free 6 A/250 V AC. 230 V LED lamps up to 50 W, incandescent lamp load 500 W. No standby loss.

Modular device for DIN-EN 60715 TH35 rail mounting. 1/2 module = 9 mm wide, 55 mm deep.
 State-of-the-art hybrid technology combines advantages of nonwearing electronic control with high capacity of special relays.
 Control voltages 12 V UC.
 Contact position indicator with LED. Control power demand 0.2 W only.
Safe disconnection to VDE 0106, Part 101; therefore, these devices can also be used as coupling relays.

KR09-12V UC	Coupling relay, 1 NO contact 6 A	Art. No. 22100705	44,60 €/pc.
-------------	----------------------------------	-------------------	-------------

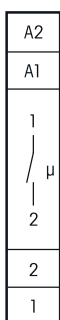

Manuals and documents in further languages:
<http://eltako.com/redirect/KR09-24V-UC>

Technical data page 12-16.
 Housing for operating instructions
 GBA14 page 1-49 chapter 1.

KR09-24V UC



1 NO contact potential free 6 A/250 V AC. 230 V LED lamps up to 50 W, incandescent lamp load 500 W. No standby loss.

Modular device for DIN-EN 60715 TH35 rail mounting. 1/2 module = 9 mm wide, 55 mm deep.
 State-of-the-art hybrid technology combines advantages of nonwearing electronic control with high capacity of special relays.
 Control voltages 24 V UC.
 Contact position indicator with LED. Control power demand 0.2 W only.
Safe disconnection to VDE 0106, Part 101; therefore, these devices can also be used as coupling relays.

KR09-24V UC	Coupling relay, 1 NO contact 6 A	Art. No. 22100706	41,10 €/pc.
-------------	----------------------------------	-------------------	-------------

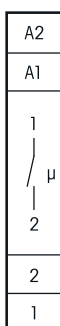

Manuals and documents in further languages:
<http://eltako.com/redirect/KR09-230V>

Technical data page 12-16.
 Housing for operating instructions
 GBA14 page 1-49 chapter 1.

KR09-230V



1 NO contact potential free 6 A/250 V AC. 230 V LED lamps up to 50 W, incandescent lamp load 500 W. No standby loss.

Modular device for DIN-EN 60715 TH35 rail mounting. 1/2 module = 9 mm wide, 55 mm deep.
 State-of-the-art hybrid technology combines advantages of nonwearing electronic control with high capacity of special relays.
 Control voltages 230 V.
 Contact position indicator with LED. Control power demand 0.2 W only.
Safe disconnection to VDE 0106, Part 101; therefore, these devices can also be used as coupling relays.

KR09-230V	Coupling relay, 1 NO contact 6 A	Art. No. 22100730	41,10 €/pc.
-----------	----------------------------------	-------------------	-------------

COUPLING RELAY KRW12DX-UC

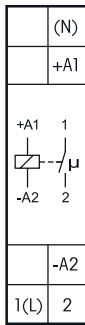

Typical connection

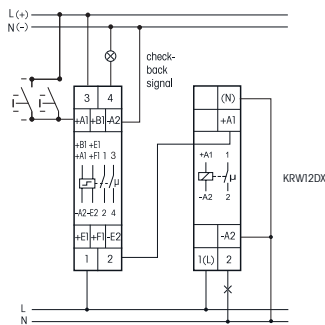

ES12Z with KRW12DX-UC

If N is connected, the zero passage switching is active.



Manuals and documents in further languages:
<http://eltako.com/redirect/KRW12DX-UC>

Housing for operating instructions
GBA14 page 1-49 chapter 1.

KRW12DX-UC



1 NO contact potential free 16 A/250 V AC with tungsten pre-contact. The pre-run contact closes before the main contact and thus handles inrush current from LED lamps that occurs over a few ms. Max. inrush current 500 A/2 ms. 230 V LED lamps up to 600 W, incandescent lamp load 3300 W. No standby loss.

Modular device for DIN-EN 60715 TH35 rail mounting. 1 module = 18 mm wide, 58 mm deep. State-of-the-art hybrid technology combines advantages of nonwearing electronic control with high capacity of special relays.

With the patented Eltako Duplex technology (DX) the normally potential-free contacts can still switch in zero passage when switching 230 V AC 50 Hz and therefore drastically reduce wear. Simply connect the neutral conductor to the terminal (N) and L to 1(L) for this. This gives an standby consumption of only 0.1 watt.

If the contact is used for controlling switching devices which do not perform zero passage switching themselves, (N) should not be connected because the additional closing delay otherwise causes the opposite effect.

Universal control voltage 12 to 230 V UC.

Low switching noise.

Contact position indicator with LED.

By using a bistable relay coil power loss and heating is avoided even in the on mode.

The relay contact can be open or closed when putting into operation. It will be synchronised at first operation.

This relay is not suitable to feed back the switching voltage signal of a dimmer switch.

Use only relays ESR12DDX-UC, ESR12NP-230V+UC or ESR61NP-230V+UC for this purpose.

The electronics does not have an internal power supply and therefore no standby loss.

The microcontroller is activated when the control contact closes. This switches the bistable relay to the correct direction. The bistable relay switches back either when the control contact opens or when the control voltage falls.

KRW12DX-UC	Coupling relay, 1 NO contact 16 A	Art. No. 22100800	55,00 €/pc.
-------------------	-----------------------------------	--------------------------	--------------------

SWITCHING RELAY ER61-UC IMPULSE SWITCH WITH INTEGRATED RELAY FUNCTION ESR61NP-230V+UC

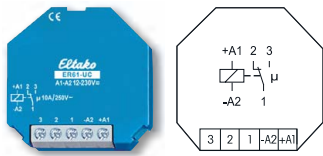

Typical connection

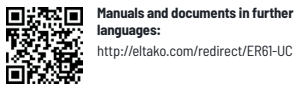
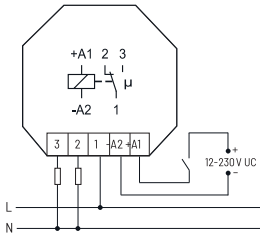

Technical data page 12-16.

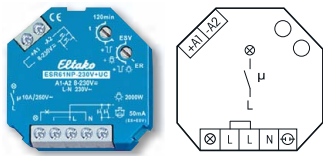

Function rotary switches

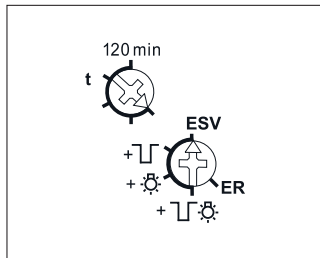

Standard setting ex works.

Typical connection

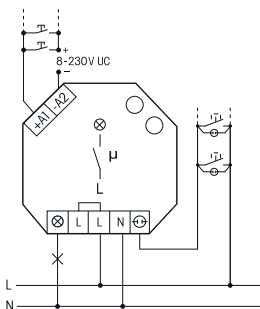

Technical data page 12-16.

ER61-UC



1 CO contact potential free 10 A/250 V AC. 230 V LED lamps up to 200 W, incandescent lamp load 2000 W. No standby loss.

For installation. 45 mm long, 45 mm wide, 18 mm deep.

State-of-the-art hybrid technology combines advantages of nonwearing electronic control with high capacity of special relays. Universal control voltage 12 to 230 V UC. Low switching noise.

By using a bistable relay coil power loss and heating is avoided even in the on mode.

The relay contact can be open or closed when putting into operation. It will be synchronised at first operation.

This relay is not suitable to feed back the switching voltage signal of a dimmer switch.

Use only relays ESR12DDX-UC, ESR12NP-230V+UC or ESR61NP-230V+UC for this purpose.

The electronics does not have an internal power supply and therefore no standby loss.

The microcontroller is activated when the control contact closes. This switches the bistable relay to the correct direction. The bistable relay switches back either when the control contact opens or when the control voltage falls.

ER61-UC	Switching relay, 1 CO contact 10 A	Art. No. 61001601	54,70 €/pc.
---------	------------------------------------	-------------------	-------------

ESR61NP-230V+UC



1 NO contact not potential free 10 A/250 V AC, 230 V LED lamps up to 600 W, incandescent lamp load 2000W. Off delay impulse switch with switch-off early warning and pushbutton permanent light switchable. Standby loss 0.7 watt only.

For installation. 45 mm long, 45 mm wide, 18 mm deep.

Zero passage switching to protect contacts and lamps.

State-of-the-art hybrid technology combines advantages of nonwearing electronic control with high capacity of special relays.

By using a bistable relay coil power loss and heating is avoided even in the on mode.

The switched consumer may not be connected to the mains before the short automatic synchronisation after installation has terminated.

Control voltage 230 V. In addition electrically isolated universal control voltage from 8 to 230 V UC. Supply voltage and switching voltage 230 V. Very low switching noise. Variable time range up to 120 minutes in the function ESV. At the control input \oplus pushbuttons with a glow lamp current up to 50 mA can be connected.

In case of a power failure the system is disconnected in a preset sequence.

If the timing period is set to minimum in the function ESV, the release delay is switched off.

The standard impulse switch function ES is then set. The function ER is selectable. If the function ER is selected a glow lamp current is not permitted. Only the control input A1- A2 should be used.

When set to the function ER this device is suitable to feed back the switching voltage signal of a dimmer switch.

If switch-off early warning function \square is switched on, the light starts flickering approx. 30 seconds before time-out. This is repeated three times at decreasing time intervals.

If the permanent light function \odot is switched on, the function can be activated by pressing the pushbutton for longer than 1 second. This function switches off automatically after 2 hours or by pressing the pushbutton for longer than 2 seconds.

If both switch-off early warning function and permanent light by pushbutton $\square \odot$ are set, the switch-off early warning function is activated before switching off the permanent light.

ESR61NP-230V+UC	Switching relay, 1 NO contact 10 A	Art. No. 61100001	58,10 €/pc.
-----------------	------------------------------------	-------------------	-------------

MULTIFUNCTION IMPULSE SWITCH WITH INTEGR. RELAY FUNCTION ESR61M-UC

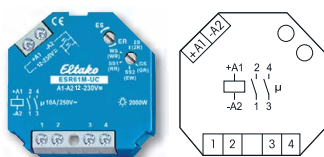

ESR61M-UC



1+1 NO contacts potential free 10 A/250 V AC. 230 V LED lamps up to 200 W, incandescent lamp load 2000 W. No standby loss.

Function rotary switches

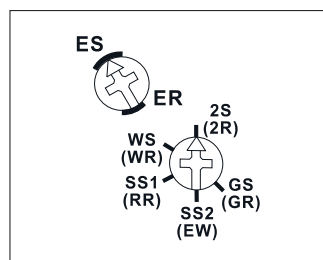

Standard setting ex works.

Typical connection

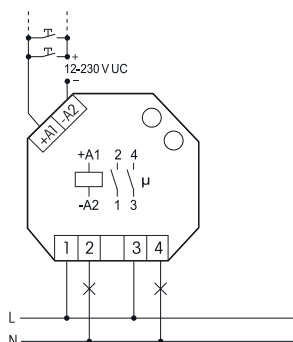

For installation. 45 mm long, 45 mm wide, **32 mm deep.**

State-of-the-art hybrid technology combines advantages of nonwearing electronic control with high capacity of special relays.

Universal control voltage 12 to 230 V UC.

No permanent power supply necessary, therefore no standby loss.

By using bistable relays coil power loss and heating is avoided even in the on mode.

The switched consumer may not be connected to the mains before the short automatic synchronisation after installation has terminated.

The functions of the second rotary switch are preselected using the rotary switch ES/ER.

The setting ER selects the function in brackets. 10 different functions are selectable.

2S = Impulse switch with 2 NO contacts

(2R) = Switching relay with 2 NO contacts

WS = Impulse switch with 1 NO contact and 1 NC contact

(WR) = Switching relay with 1 NO contact and 1 NC contact

SS1 = Impulse multi circuit switch 1+1 NO contacts for switching sequence

0 - contact 1(1-2) - contact 2(3-4) - contacts 1 + 2

(RR) = Switching relay (closed-circuit current relay) with 2 NC contacts

SS2 = Impulse multi circuit switch 1+1 NO contacts for switching sequence

0 - contact 1 - contacts 1 + 2 - contact 2

(EW) = Impulse relay for fleeting NO contact with 1 NO contact and 1 NC contact,

wiping time 1 sec

GS = Impulse group switch 1+1 NO contacts for switching sequence

0 - contact 1 - 0 - contact 2

(GR) = Group relay 1+1 NO contacts (relay with alternating closing contacts)

This relay is not suitable to feed back the switching voltage signal of a dimmer switch.

Use only relays ESR12DDX-UC, ESR12NP-230V+UC or ESR61NP-230V+UC for this purpose.

The electronics does not have an internal power supply and therefore no power is consumed in any contact position. A control current flows only during a short control impulse of 0.2 seconds. This activates the microcontroller, reads the last switching state from the non-voltage memory, switches the bistable relay to its opposite state accordingly and rewrites the new switching state to memory

Manuals and documents in further languages:
<http://eltako.com/redirect/ESR61M-UC>

Technical data page 12-16.

ESR61M-UC	Multifunction Impulse Switch with integr. relay function, 1+1 NO contacts 10 A	Art. No. 61200301	71,90 €/pc.
------------------	--	--------------------------	--------------------

NOISELESS IMPULSE SWITCH WITH INTEGRATED RELAY FUNCTION ESR61SSR-230V WITH SOLID STATE RELAY

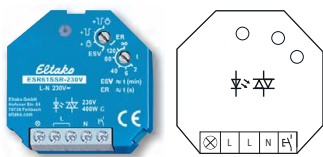

ESR61SSR-230V



Noiseless solid state relay not potential free. 230 V LED lamps up to 400 W, incandescent lamp load 400 W. Off delay impulse switch with switch-off early warning and pushbutton permanent light switchable. Standby loss 0,3 Watt only.

Function rotary switches

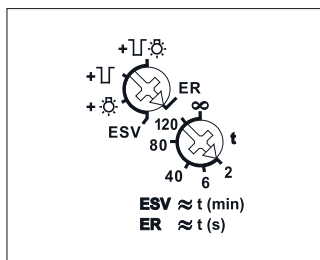

Standard setting ex works.

Typical connection

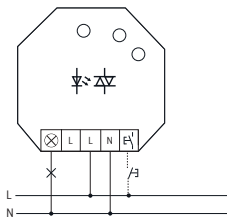

Manuals and documents in further languages:
<http://eltako.com/redirect/ESR61SSR-230V>

Technical data page 12-16.

For installation. 45 mm long, 45 mm wide, 18 mm deep.

Supply, switching and control voltage 230 V.

Zero passage switching.

In case of a power failure the system is disconnected in a preset sequence.

In the ER function the relay switches back on when the power is restored and the control input is active.

It is not permitted to apply a glow lamp current to the control input.

With automatic electronic overtemperature switch-off.

At a load of < 1W a GLE must be switched in parallel to the load.

Use the top rotary switch to select the required function of this impulse switch:

ER = switching relay

ESV = impulse switch. Possibly with off delay, then

+ [pushbutton permanent light] = ESV with pushbutton permanent light

+ [switch-off early warning] = ESV with switch-off early warning

+ [pushbutton permanent light and switch-off early warning] = ESV with pushbutton permanent light and switch-off early warning

The LED flashes when the rotary switch reaches a new setting range to assist you to find the require position with certainty.

The LED lights up permanently when the relay is switched on.

When the pushbutton permanent light is switched on [pushbutton permanent light], set the LED to permanent light by pressing the pushbutton for longer than 1 second. This is indicated by the LED flickering briefly. After 2 hours, the permanent light switches off automatically or it can be switched off previously by briefly pressing the pushbutton.

If the switch-off early warning [switch-off early warning] is switched on, the light starts to flicker approx. 30 seconds before time-out. This is repeated three times at decreasing time intervals.

During the switch-off early warning, the light can be switched back on by briefly pressing the pushbutton.

If both switch-off early warning and pushbutton permanent light [pushbutton permanent light] are switched on, switch-off early warning is activated before automatic switch-off of the permanent light.

The function **ESV on the bottom rotary switch** sets the off delay from 2 to 120 minutes.

In setting ∞ normal impulse switch function ES without off delay, without pushbutton permanent light and without switch-off early warning.

In the ER function a switch-on wipe time can be set between 2 and 120 seconds. On expiry of the wipe time the relay switches off automatically.

In setting ∞ default relay function ER without wipe time.

ESR61SSR-230V	Noiseless impulse switch with integrated relay function with solid state relay	Art. No. 61100003	55,90 €/pc.
----------------------	--	--------------------------	--------------------

ISOLATING RELAYS ETR61-230V AND ETR61NP-230V

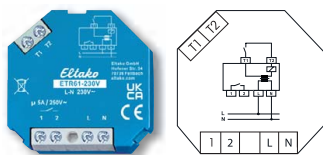

Typical connection

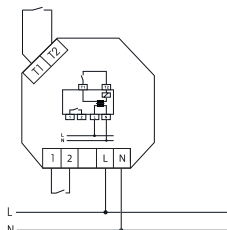

Manuals and documents in further languages:
<http://eltako.com/redirect/ETR61-230V>

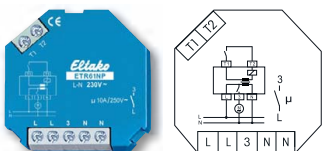

Typical connection

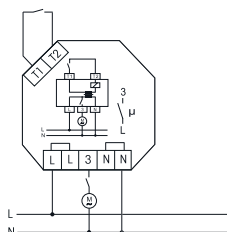

Manuals and documents in further languages:
<http://eltako.com/redirect/ETR61NP-230V>

Technical data page 12-16.

ETR61-230V



1 NO contact potential free 5 A/250 V AC. 230 V LED lamps up to 50 W, incandescent lamp load 1000 W. Standby loss 0.7 watt only.

For installation. 45 mm long, 45 mm wide, 18 mm deep.

State-of-the-art hybrid technology combines advantages of nonwearing electronic control with high capacity of special relays.

Control input with internally produced low voltage 24 V DC. With an isolating transformer electrically isolated from power supply and make contact (PELV).

Therefore no external low voltage power supply necessary.

Spacing between power supply and contact: 6 mm.

Power supply 230 V.

ETR61-230V	Isolating relay, 1 NO contact 5 A	Art. No. 61100635	45,60 €/pc.
-------------------	-----------------------------------	--------------------------	--------------------

ETR61NP-230V



1 NO contact not potential free 10 A/250 V AC. 230 V LED lamps up to 100 W, incandescent lamp load 2000 W. With window contact. Standby loss 0.5 watt only.

For installation. 45 mm long, 45 mm wide, 18 mm deep.

State-of-the-art hybrid technology combines advantages of nonwearing electronic control with high capacity of special relays.

Control input with internally produced low voltage 24 V DC. With an isolating transformer electrically isolated from power supply and make contact (PELV).

Therefore no external low voltage power supply necessary.

With 2 L terminals and 2 N terminals for an easy and quick installation.

Power supply 230 V.

ETR61NP-230V	Isolating relay, 1 NO contact 10 A	Art. No. 61100630	45,60 €/pc.
---------------------	------------------------------------	--------------------------	--------------------

ISOLATING RELAY ETR61NP-230V WITH WINDOW CONTACT FK, WINDOW CONTACT FK

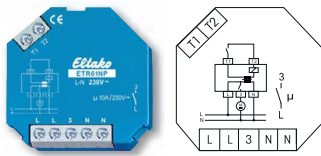

Typical connection

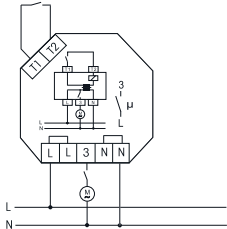

The power supply of an extractor hood is connected by a window contact (NO if window open) so it can be switched on only if the window is open.

Window contact FK



Reed relay and solenoid each
54 x 12 x 10 mm



Manuals and documents in further languages:
http://eltako.com/redirect/ETR61NP-230V*FK

Technical data page 12-16.

Window contact FK



Reed relay and solenoid each
54 x 12 x 10 mm



Manuals and documents in further languages:
<http://eltako.com/redirect/FK>

ETR61NP-230V+FK



1 NO contact not potential free 10 A/250 V AC. 230 V LED lamps up to 100 W, incandescent lamp load 2000 W. With window contact. Standby loss 0.5 watt only.

For installation. 45 mm long, 45 mm wide, 18 mm deep.

State-of-the-art hybrid technology combines advantages of nonwearing electronic control with high capacity of special relays.

Control input with internally produced low voltage 24 V DC. With an isolating transformer electrically isolated from power supply and make contact (PELV).

Therefore no external low voltage power supply necessary.

With 2 L terminals and 2 N terminals for an easy and quick installation.

Power supply 230 V.

The enclosed window contact consists of a Reed relay with terminals and a solenoid. The NC contact opens when the solenoid approaches closer than 25 mm. The disconnection relay ETR61NP is connected to terminals T1 and T2. Power supply to the extractor only cuts in when the window is open. ETR61NP can be wired in the flush mounted socket behind the socket for the extractor.

Mounting the window contact FK:

Lever out the inserts at the narrow end of the housing. Wire up the Reed relay and cut out the cable entry on the housing. Affix the two housings in parallel maximum 15 mm apart and also screw if necessary. In the longitudinal direction the solenoid may be twisted in any direction compared to the Reed relay.

ETR61NP-230V+FK	Isolating relay with window contact, 1 NO contact 10 A	Art. No. 61100631	78,40 €/pc.
------------------------	--	--------------------------	--------------------

FK

Window contact

The window contact as described above is also supplied as individual (accessory) item. Reed relay with 1 NC contact, switching capacity 5 W or VA. Switching voltage max. 175 V UC.

FK	Window contact, reed relay with 1 NC contact	Art. No. 20000086	32,80 €/pc.
-----------	--	--------------------------	--------------------

TECHNICAL DATA ELECTRONIC SWITCHING RELAYS, CONTROL RELAYS AND COUPLING RELAYS

Type	ESR12NP-230V+UC	ESR12DDX-UC ^{b)} ER12DX-UC ^{a)} ER12-200-UC ^{a)} ER12-110-UC ^{a)} ER12-001-UC ^{a)} ER12-002-UC ^{a)}	ESR61NP-230V+UC ^{b)} ESR61M-UC ^{a)} ETR61-230V ETR61NP-230V ER61-UC ^{a)}	ER12SSR-UC ESR61SSR-230V	KR09 -12V UC, -24V UC, -230V	KRW12DX-UC ^{a)}
Contacts						
Contact material/contact gap	AgSnO ₂ /0.5 mm			Opto Triac	AgSnO ₂ /0.5 mm	W+AgSnO ₂ /0.5 mm
Spacing of control connections/contact	3 mm	6 mm	6 mm, ER61: 3 mm		6 mm	6 mm
Spacing of control connections C1-C2 or A1-A2/contact	6 mm	6 mm	ESR61NP+M: 6 mm	–	–	–
Test voltage contact/contact	–	ESR12DDX, ER12-200/110: 2000 V	ESR61M: 2000 V	–	–	–
Test voltage control connections/contact	2000 V	4000 V	2000 V	–	4000 V	4000 V
Test voltage C1-C2 or A1-A2/contact	4000 V	–	ESR61NP+M+ETR61NP: 4000 V	–	–	–
Rated switching capacity	16 A/250 V AC	16 A/250 V AC ⁴⁾	10 A/250 V AC ETR61: 5 A/250 V AC	–	6 A/250 V AC	16 A/250 V AC
230 V LED lamps	up to 600 W ⁵⁾ I on ≤ 30 A/20 ms	up to 200 W ⁵⁾ with DX up to 600 W ⁵⁾ I on ≤ 120 A/5 ms	up to 200 W ⁵⁾ ESR61NP: up to 600 W ⁵⁾ I on ≤ 120 A/5 ms	up to 400 W ⁵⁾ I on ≤ 120 A/20 ms	up to 50 W ⁵⁾ I on ≤ 10 A/10 ms	up to 600 W ⁵⁾ I on ≤ 500 A/2 ms
Incandescent lamp and halogen lamp load ¹⁾ 230 V, I on ≤ 70 A/10 ms	2300 W	2000 W	2000 W ETR61: 1000 W	up to 400 W	500 W	3300 W
Fluorescent lamp load with KVG* in lead-lag circuit or non compensated	1000 VA	1000 VA	1000 VA	–	600 VA	1000 VA
Fluorescent lamp load with KVG* shunt-compensated or with EVG*	500 VA	500 VA	500 VA	up to 400 VA ⁵⁾	300 VA	500 VA
Compact fluorescent lamps with EVG* and energy saving lamps ESL	15x7 W 10x20 W ⁵⁾	I on ≤ 70 A/10 ms ²⁾ When using DX types: 15x7 W 10x20 W ^{3/5)}	I on ≤ 70 A/10 ms ²⁾ ESR61NP: 15x7 W, 10x20 W ⁵⁾	up to 400 W ⁵⁾	52 W	I on ≤ 500 A/2 ms ²⁾
Max. switching current DC: 12 V/24 V DC	–	8 A	8 A (not ESR)	–	6 A	–
Life at rated load, cos φ = 1 or for incandescent lamps 1000 W at 100/h	> 10 ⁵	> 10 ⁵	> 10 ⁵	∞	> 10 ⁵	> 10 ⁵
Life at rated load, cos φ = 0.6 at 100/h	> 4x10 ⁴	> 4x10 ⁴	> 4x10 ⁴	–	–	> 4x10 ⁴
Max. operating cycles	10 ³ /h	10 ³ /h	10 ³ /h	10 ³ /h	10 ⁴ /h	10 ³ /h
Contact position indication	LED (not series 61)					
Maximum conductor cross-section	series 12: 6 mm ² (3-fold terminal 4 mm ²), series 61: 4 mm ²					
Two conductors of same cross-section	series 12: 2.5 mm ² (3-fold terminal 1.5 mm ²), series 61: 1.5 mm ²					
Screw head	series 12: slotted/crosshead, pozidriv, series 61: slotted/crosshead					
Type of enclosure/terminals	series 12: IP50/IP20, series 61: IP30/IP20					
Electronics						
Time on	100%					
Max./min. temperature at mounting location	+50°C/-20°C					
Stand by loss (active power)	0.5 W	– ESR12DDX: 0.4 W	– ESR61NP: 0.7 W, ETR61+ ETR61NP: 0.5 W	– ESR61SSR: 0.3 W	–	–
Control current 230 V control input local ±20%	10 mA	–	10 mA, ER61 and ESR61M: –	1 mA	–	–
Control current universal control voltage all control voltages mA ±20%	–	4 (not ESR12DDX)	ER61: 2, ESR61M: 4	4	–	4
Control current at 8/12/24/230 V (<10 s) mA ±20%	2/4/9/5(100)	only ESR12DDX: 2/3/7/3(50) mA	only ESR61NP: 2/4/9/5(100) only ETR61+ ETR61NP: 10 mA/24 V DC	–	–/15/10/11	–
Max. parallel capacitance (approx. length) of control lead at 230 V AC	ES: 0.3 μF (1000 m) ER: 3 nF (10 m) C1-C2: 15 nF (50 m)	0.06 μF (200 m) ESR12DDX: 0.3 μF (1000 m)	0.06 μF (200 m)	30 nF (100 m)	0.06 μF (200 m)	0.06 μF (200 m)

* EVG = electronic ballast units; KVG = conventional ballast units^{a)} Bistable relay as relay contact. The relay contact can be open or closed when putting into operation. It will be synchronised at first operation.
^{b)} Bistable relay as relay contact. The switched consumer may not be connected to the mains before the short automatic synchronisation after installation has terminated.
¹⁾ For lamps with 150 W max.
²⁾ A 40-fold inrush current must be expected for electronic ballast devices. For steady loads of 1200 W or 600 W use the current limiting relay SBR12 or SBR61. See chapter 14, page 14-8.
³⁾ When using DX types close attention must be paid that zero passage switching is activated!
⁴⁾ For ER12-200 maximum current across both contacts 16 A for 230 V.
⁵⁾ Usually applies for dimmable 230 V LED lamps and dimmable energy saving lamps. Due to different lamp electronics and depending on the manufacturer, the maximum number of lamps may be limited, especially if the wattage of the individual lamps is very low (e.g. with 2 W LEDs).
⁶⁾ Up to 2x10⁴ switching cycles at 1 s on & 9 s off.

To comply with DIN VDE 0100-443 and DIN VDE 0100-534, a Type 2 or Type 3 surge protection device (SPD) must be installed.

MFZ12DBT S2U12DBT-UC ASSU-BT/ 230V



Etlako Connect-App

13

**TIME FUNCTIONS SOLVED:
THE PERFECT SOLUTION
FOR EVERY CHALLENGE**

Multifunction time relays, time relays and timers

Selection table multifunction time relays, time relays and timers	13 - 2
Analogue settable multifunction time relay MFZ12-230V with 10 functions	13 - 3
Analogue settable multifunction time relay MFZ12DX-UC with 18 functions	13 - 4
Digital settable multifunction time relay with display and Bluetooth MFZ12DBT-UC with Eltako Connect app and 18 functions	13 - 5
Digital settable multifunction time relay MFZ12DDX-UC with 18 functions	13 - 6
Analogue settable multifunction time relay MFZ12NP-230V+UC with 10 functions	13 - 7
Fully electronic multifunction time relay MFZ12PMD-UC with 18 functions	13 - 8
Analogue settable multifunction time relay MFZ61DX-UC with 6 functions	13 - 9
Analogue settable 2-stage ON-delay A2Z12-UC	13 - 10
Analogue settable time relay with operate delay AVZ12DX-UC	13 - 11
Analogue settable time relay with fleeting NO contact and fleeting NC contact EAW12DX-UC	13 - 12
Test pushbutton for emergency lighting with off-delay PTN12-230V	13 - 13
Analogue settable time relay with release delay RVZ12DX-UC	13 - 14
Analogue settable clock generator starting with impulse TGI12DX-UC	13 - 15
2-channel timer with display and Bluetooth SU12DBT/1+1-UC with Eltako Connect app	13 - 16
NEW 2-channel timer with display and Bluetooth SU12DBT-UC with Eltako Connect app	13 - 17
NEW Outdoor socket timer with Bluetooth ASSU-BT/230V	13 - 18
Digital settable timer with 2 channels S2U12DDX-UC	13 - 19
Description of functions of the multifunction time relays and time relays	13 - 20
Technical data multifunction time relays, time relays and timers	13 - 21

THE SUCCESSFUL

Multifunction time relays with up to 18 functions combined with universal control voltage 8 to 230 V UC - a competitive advantage, particularly the digital settable time relays MFZ12DDX.

NP multifunction time relays always switch at zero passage, the DX devices only when connected to N.

Page	13-3	13-4	13-5	13-6	13-7	13-8	13-9	13-10	13-11	13-12	13-13	13-14	13-15	13-16	13-17	13-18	13-19	
	pictograms	MFZ12-230V	MFZ12DX-UC	MFZ12DBT-UC	MFZ12DDX-UC	MFZ12NP-230V+UC	MFZ12PMD-UC	MFZ61DX-UC	A2Z12-UC	AVZ12DX-UC	EAW12DX-UC	PTN12-230V	RVZ12DX-UC	TG12DX-UC	SUI2DBT/1+1-UC	S2UI2DBT-UC	ASSU-BT/230V	S2UI2DDX-UC
Modular device for mounting on DIN rail EN 60715 TH35, number of modules 18 mm each		1	1	1	1	1	1		1	1	1	1	1	1	2		1	
Built-in device for installation (e.g. flush-mounting box)								■										
Digital settable				■	■		■								■	■	■	
Analogue settable		■	■			■		■	■	■	■	■	■	■				
Number of NO contacts (not potential free)		1				(1)	(1)	1	1+1						1+1		1+1	
Number of CO contacts potential free			1	1	1					1	1	(1)	1	1		1+1	1	
Zero passage switching		■ ³⁾	■ ³⁾	■ ³⁾	■ ³⁾	■	■	■ ³⁾		■ ³⁾	■ ³⁾		■ ³⁾	■ ³⁾	■ ³⁾	■ ³⁾	■ ³⁾	
Switching capacity 16 A/250 V AC						■						■			■		■	
Switching capacity 10 A/250 V AC		■	■	■	■			■	■	■	■		■	■		■		
Incandescent lamp load W		1000	2000	2000	2000	2300	400 ¹⁾	2000	1000	2000	2000	2300	2000	2000	2000	2000	2300	2000
Bistable relay as relay contact		■ ²⁾	■ ²⁾	■ ²⁾	■ ²⁾			■ ²⁾	■ ²⁾	■ ²⁾	■ ²⁾		■ ²⁾	■ ²⁾	■ ²⁾	■ ²⁾	■ ²⁾	■ ²⁾
Universal control voltage			■	■	■	■	■	■	■	■	■	■	■	■	■	■	■	
Low standby loss		■	■	■	■	■	■	■	■	■	■	■	■	■	■	■	■	
Multifunction time relay		■	■	■	■	■	■											
Off delay RV		■	■	■	■	■	■					■	■					
Operate delay AV		■	■	■	■	■	■		■									
Additive operate delay AV+			■	■	■		■											
2-stage ON-delay								■										
Fleeting NO contact EW		■	■	■	■	■	■				■							
Fleeting NC contact AW		■	■	■	■	■	■				■							
Fleeting NO contact and fleeting NC contact EAW			■	■	■		■				■							
Operate and release delay ARV		■	■	■	■	■	■											
Additive operate and release delay ARV+			■	■	■		■											
Relay function ER			■	■	■		■											
Release-delay impulse switch SRV			■	■	■		■											
Impulse switch functions ES and ESV			■	■	■		■											
Clock generator starting with impulse TI		■	■	■	■	■	■							■				
Clock generator starting with pause TP		■	■	■	■	■	■											
Impulse controlled operate delay IA (e.g. automatic door opener)		■	■	■	■	■	■	■										
Pulse shaper IF			■	■	■		■											

¹⁾ Up to 3400 W with capacity enhancers LUD12-230V. ²⁾ The switched consumer may not be connected to the mains before the short automatic synchronisation after installation has terminated. ³⁾ Duplex technology: When switched with 230 V/50 Hz zero passage switching is activated if L is connected to (L) and N to (N). Then additional standby loss of only 0.1 watt.

ANALOGUE SETTABLE MULTIFUNCTION TIME RELAY MFZ12-230V WITH 10 FUNCTIONS

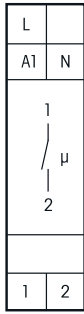

MFZ12-230V



1 NO contact potential free 10 A/250 V AC. 230 V LED lamps up to 200 W, incandescent lamps 1000 W*. Standby loss 0.4 watt only.

Modular device for DIN-EN 60715 TH35 rail mounting.
1 module = 18 mm wide, 58 mm deep.

Control voltage 230 V. Supply voltage same as control voltage.
Time setting between 0.1 second and 40 hours.

Functions F (description page 13-18)

- RV** = off delay
- AV** = operate delay
- TI** = clock generator starting with impulse
- TP** = clock generator starting with pause
- IA** = impulse controlled operate delay (e.g. automatic door opener)
- EW** = fleeting NO contact
- AW** = fleeting NC contact
- ARV** = operate and release delay
- ON** = permanent ON
- OFF** = permanent OFF

Function rotary switches

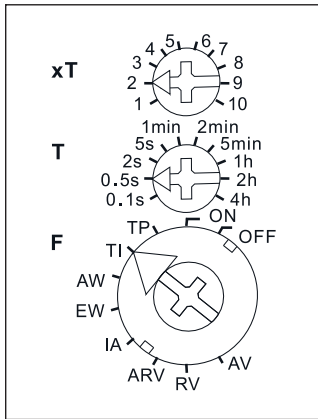

Standard setting ex works.

Typical connection

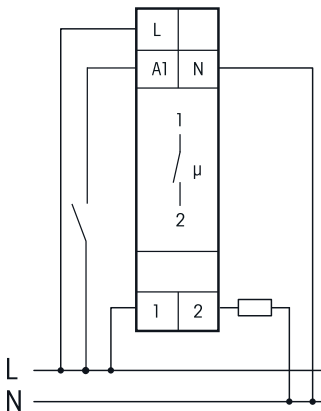

The LED below the big rotary switch indicates the contact position while time-out is in progress. It blinks while the relay contact is open, and is continuously ON as long as the relay contact is closed.

The time base T is selected by means of the middle, latching rotary switch **T**. Time-base figures available are 0.1 seconds, 0.5 seconds, 2 seconds, 5 seconds, 1 minute, 2 minutes, 5 minutes, 1 hour, 2 hours and 4 hours. The total time is obtained by multiplying the timebase by the multiplier.

The multiplier xT is set on the upper, latching rotary switch **xT** and is in the range from 1 to 10. Thus, time settings can be selected in the range from 0.1 second (time base 0.1 second and multiplier 1) and 40 hours (time base 4 hours and multiplier 10).

* The maximum load can be used starting at a delay time or clock cycle of 5 minutes.
The maximum load will be reduced for shorter times as follows: up to 2 seconds 15%, up to 2 minutes 30%, up to 5 minutes 60%.

MFZ12-230V	Analogue settable multifunction time relay, 1 NO contact 10 A	Art. No. 23100530	61,80 €/pc.
-------------------	---	--------------------------	--------------------

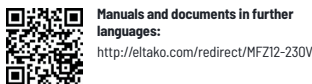

Manuals and documents in further languages:
<http://eltako.com/redirect/MFZ12-230V>

Technical data page 13-21.
Housing for operating instructions
GBA14 page 1-49 chapter 1.

ANALOGUE SETTABLE MULTIFUNCTION TIME RELAY MFZ12DX-UC WITH 18 FUNCTIONS



Function rotary switches

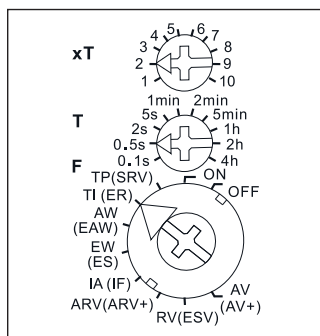

Typical connection

Level of setting 1, Functions F

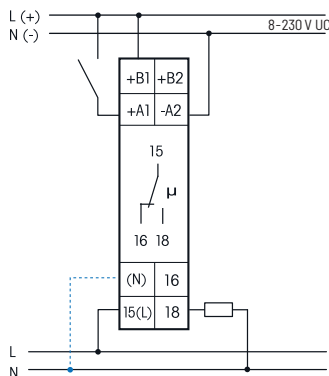

Typical connection

Level of setting 2, Functions (F)

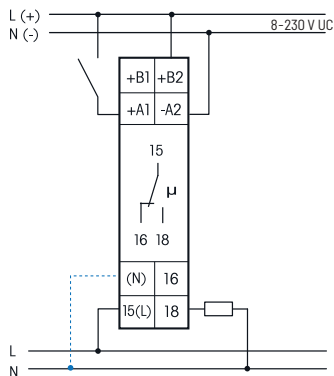

If N is connected, the zero passage switching is active.



Manuals and documents in further languages:
<http://eltako.com/redirect/MFZ12DX-UC>

Technical data page 13-21.
Housing for operating instructions
GBA14 page 1-49 chapter 1.

Recommended retail prices excluding VAT.

MFZ12DX-UC



1 CO contact potential free 10 A/250 V AC. 230 V LED lamps up to 200 W, incandescent lamps 2000 W*.
Standby loss 0.02-0.6 watt only.

Modular device for DIN-EN 60715 TH35 rail mounting. 1 module = 18 mm wide, 58 mm deep.

With the patented Eltako Duplex technology (DX) the normally potential-free contacts can still switch in zero passage when switching 230 V AC 50 Hz and therefore drastically reduce wear. Simply connect the neutral conductor to the terminal (N) and L to 15(L) for this. This gives an additional standby consumption of only 0.1 Watt.

Universal control voltage from 12 to 230 V UC. Supply voltage same as control voltage.

Time setting between 0.1 second and 40 hours.

By using a bistable relay coil power loss and heating is avoided even in the on mode.

The switched consumer may not be connected to the mains before the short automatic synchronisation after installation has terminated.

According to the connection of the power supply to the terminals B1-A2 or B2-A2 **two different levels of settings** can be selected:

Functions F with connection of the power supply to B1-A2 (description page 13-18)

(Standby loss 0.02-0.4 W)

- RV** = off delay
- AV** = operate delay
- TI** = clock generator starting with impulse
- TP** = clock generator starting with pause
- IA** = impulse controlled operate delay (e.g. automatic door opener)
- EW** = fleeting NO contact
- AW** = fleeting NC contact
- ARV** = operate and release delay
- ON** = permanent ON
- OFF** = permanent OFF

Functions (F) with connection of the power supply to B2-A2 (description page 13-18)

(Standby loss 0.02-0.6 W)

- SRV** = release-delay impulse switch
- ER** = relay
- EAW** = fleeting NO contact and fleeting NC contact
- ES** = impulse switch
- IF** = pulse shaper
- ARV+** = additive operate and release delay
- ESV** = impulse switch with release delay and switch-off early-warning function
- AV+** = additive operate delay
- ON** = permanent ON
- OFF** = permanent OFF

The LED below the big rotary switch indicates the contact position while time-out is in progress. It blinks while the relay contact 15-18 is open (15-16 closed), and is continuously ON as long as the relay contact 15-18 is closed (15-16 open).

The time base T is selected by means of the middle, latching rotary switch **T**. Time-base figures available are 0.1 seconds, 0.5 seconds, 2 seconds, 5 seconds, 1 minute, 2 minutes, 5 minutes, 1 hour, 2 hours and 4 hours. The total time is obtained by multiplying the timebase by the multiplier.

The multiplier xT is set on the upper, latching rotary switch **xT** and is in the range from 1 to 10. Thus, time settings can be selected in the range from 0.1 second (time base 0.1 second and multiplier 1) and 40 hours (time base 4 hours and multiplier 10).

- * The maximum load can be used starting at a delay time or clock cycle of 5 minutes.
- The maximum load will be reduced for shorter times as follows: up to 2 seconds 15%, up to 2 minutes 30%, up to 5 minutes 60%.

MFZ12DX-UC	Analogue settable Multifunction Time Relay 1 CO contact 10 A	Art. No. 23001005	69,80 €/pc.
-------------------	--	--------------------------	--------------------

DIGITAL SETTABLE MULTIFUNCTION TIME RELAY WITH DISPLAY AND BLUETOOTH MFZ12DBT-UC WITH ELTAKO CONNECT APP AND 18 FUNCTIONS



+B1	
+A1	-A2
(N)	16
15(L)	18

MFZ12DBT-UC



Digital settable multifunction time relay with display and Bluetooth with Eltako Connect app and 18 functions. 1 CO contact potential free 10 A/250 V AC. 230 V LED lamps up to 200 W, incandescent lamps 2000 W. With display lighting. Standby loss 0.1-0.3 watt only.

Modular device for DIN-EN 60715 TH35 rail mounting.

1 module = 18 mm wide, 58 mm deep.

With the patented Eltako Duplex technology (DX) the normally potential-free contacts can still switch in zero passage when switching 230 V AC 50 Hz and therefore drastically reduce wear. Simply connect the neutral conductor to the terminal (N) and L to 15(L) for this. This gives an additional standby consumption of only 0.1 Watt.

Universal control voltage 12 to 230 V UC. Supply voltage same as the control voltage.

Both functions and times are entered at the touch of a key and indicated digitally on an LC display.

Only two keys are required for this purpose.

When setting the time all values can be entered within preset time ranges (0.1 to 9.9 or 1 to 99 seconds, minutes or hours). The longest possible setting is 99 hours. 600 settings are possible. The time setting is continuously displayed digitally.

Functions (description page 13-18)

RV = off delay

AV = operate delay

AV+ = operate delay additive

TI = clock generator starting with impulse

TP = clock generator starting with pause

IA = impulse controlled pickup delay
(e.g. automatic door opener)

IF = pulse shaper

EW = fleeting NO contact

AW = fleeting NC contact

EAW = fleeting NO contact and
fleeting NC contact

ARV = operate and release delay

ARV+ = operate and release delay additive

ES = impulse switch

SRV = release-delay impulse switch

ESV = impulse switch with release delay
and switch-off early-warning
function

ER = relay

ON = permanent ON

OFF = permanent OFF

With TI, TP, IA, EAW, ARV and ARV+ functions, a different second time can be entered also with different time ranges.

The time relay is set either via Bluetooth with the app or with the MODE and SET buttons, a button lock is possible.

The display lighting is switched on by pressing MODE or SET for the first time.

20 seconds after you last press MODE or SET, the program returns automatically to normal display and the display illumination goes off.

Connect the timer to the app:

Press SET, the display shows **BLE** (Bluetooth) and the ID of the timer. The connection to the app can now be established (delivery state **PIN 123123**).

Scan the QR code on the operating instructions, the app guides you through the learning process. After the connection to the app has been established, **BLE+** appears in the display. The MODE and SET buttons are now locked. After 20 minutes without interacting with the timer, the connection is automatically disconnected.

Change PIN: The PIN for the Bluetooth connection can be changed in the app under the **Device PIN** entry.

Bluetooth reset (delete any changed PIN): The connection to the app must be disconnected. Press MODE and SET simultaneously for 2 seconds, **RES** flashes in the display. Now press SET for 2 seconds, **BLE** appears in the display. If you confirm with SET, the BLE reset is carried out, the PIN is deleted and the delivery status is restored.

Set the time relay with the MODE and SET buttons:

Pressing the MODE button selects the LCD element to be changed. The element currently being accessed flashes. Pressing the SET button changes the element being accessed. This can be the function, time frame, time T1 or time T2 (TI, TP, IA, EAW, ARV and ARV+ only). Each entry is terminated with the MODE key. After setting the time with MODE, no element flashes anymore - the time relay is ready for operation.

Security in the event of a power failure: The parameters set are saved in an EEPROM and are therefore immediately available again after a power failure.

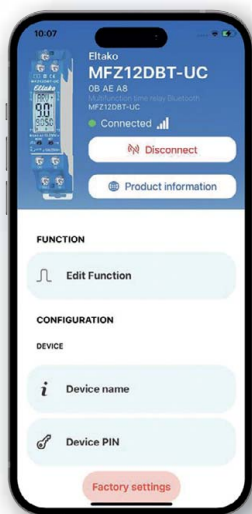

Eltako Connect-App

<http://eltako.com/redirect/eltako-connect>



Manuals and documents in further languages:
<http://eltako.com/redirect/MFZ12DBT-UC>

Technical data page 13-21.
Housing for operating instructions
GBA14 page 1-49 chapter 1.

MFZ12DBT-UC	Digital settable multifunction time relay with display and Bluetooth, 1 CO contact 10 A	Art. No. 23001003	101,10 €/pc.
--------------------	---	--------------------------	---------------------

DIGITAL SETTABLE MULTIFUNCTION TIME RELAY MFZ12DDX-UC WITH 18 FUNCTIONS



MFZ12DDX-UC



1 CO contact potential free 10 A/250 V AC. 230 V LED lamps up to 200 W, incandescent lamps 2000 W*.
Standby loss 0.05–0.5 watt only.

Modular device for DIN-EN 60715 TH35 rail mounting.

1 module = 18 mm wide, 58 mm deep.

With the patented Eltako Duplex technology (DX) the normally potential-free contacts can still switch in zero passage when switching 230 V AC 50 Hz and therefore drastically reduce wear. Simply connect the neutral conductor to the terminal (N) and L to 15(L) for this. This gives an additional standby consumption of only 0.1 Watt.

Universal control voltage 12 to 230 V UC. Supply voltage same as the control voltage.

Both functions and times are entered at the touch of a key and indicated digitally on an LC display.

Only two keys are required for this purpose.

When setting the time all values can be entered within preset time ranges (0.1 to 9.9 or 1 to 99 seconds, minutes or hours). The longest possible setting is 99 hours. 600 settings are possible. The time setting is continuously displayed digitally.

By using a bistable relay coil power loss and heating is avoided even in the on mode.

The switched consumer may not be connected to the mains before the short automatic synchronisation after installation has terminated.

Typical connection

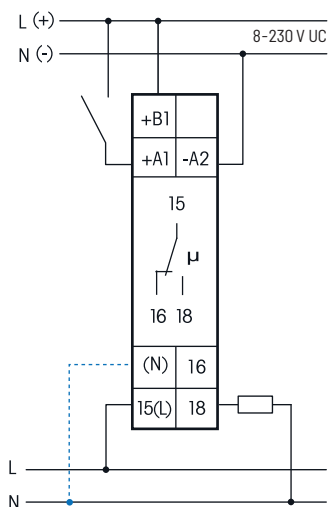

If N is connected, the zero passage switching is active.

Functions (description page 13-18)

RV = off delay

AV = operate delay

AV+ = operate delay additive

TI = clock generator starting with impulse

TP = clock generator starting with pause

IA = impulse controlled pickup delay (e.g. automatic door opener)

IF = pulse shaper

EW = fleeting NO contact

AW = fleeting NC contact

ARV = operate and release delay

ARV+ = operate and release delay additive

ES = impulse switch

SRV = release-delay impulse switch

ESV = impulse switch with release

delay and switch-off early-warning function

ER = relay

ON = permanent ON

OFF = permanent OFF

With TI, TP, IA, EAW, ARV and ARV+ functions, a different second time can be entered also with different time ranges.

Setting the times and functions: The LCD component to be changed is selected by pressing the MODE key. The component accessed flashes. Press the SET key to change the component accessed. This may be the function, the time ranges, time T1 or time T2 (on TI, TP, IA, EAW, ARV and ARV+ only). Pressing the MODE key terminates each input. Once the time has been set with MODE, no more components are flashing. The timing relay is now ready to operate. Press the MODE key again to restart the input cycle. All the entered parameters are retained if they are not changed using SET. 25 sec. after the last operation and if the component still flashes the input cycle is automatically terminated and the previously made changes lapse.

Functions of the LC display: If the ON or OFF function was selected, no time is displayed, only ON and OFF and a contact symbol in the correct position. On all other functions, the set time, the function code and the contact symbol are shown in the correct position (open or closed). The clock symbol flashes while the set time is elapsing and the remaining time is shown.

Safety in the event of a power failure: The set parameters are stored in an EEPROM and are therefore immediately available again when the power supply is restored after a power failure.

* The maximum load can be used starting at a delay time or clock cycle of 5 minutes.

The maximum load will be reduced for shorter times as follows: up to 2 seconds 15%, up to 2 minutes 30%, up to 5 minutes 60%.

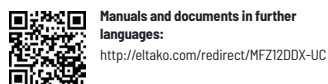

Manuals and documents in further languages:
<http://eltako.com/redirect/MFZ12DDX-UC>

Technical data page 13-21.
Housing for operating instructions
GBA14 page 1-49 chapter 1.

MFZ12DDX-UC	Digital settable multifunction time relay, 1 CO contact 10 A	Art. No. 23001004	70,10 €/pc.
--------------------	---	--------------------------	--------------------

ANALOGUE SETTABLE MULTIFUNCTION TIME RELAY MFZ12NP-230V+UC WITH 10 FUNCTIONS

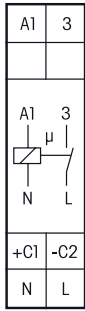

MFZ12NP-230V+UC



1 NO contact not potential free 16 A/250 V AC. 230 V LED lamps up to 200 W, incandescent lamps 2300 W*. Standby loss 0.5 watt only.

Modular device for DIN EN 60715 TH35 rail mounting.
1 module = 18 mm wide, 58 mm deep.

Zero passage switching to protect contacts and lamps.

State-of-the-art hybrid technology combines advantages of nonwearing electronic control with high capacity of special relays.

230 V control voltage and additionally 8 to 230 V UC electrically isolated universal control voltage.

230 V supply voltage and switching voltage.

Very low switching noise.

Time settings between 0.1 seconds and 40 hours.

Function rotary switches

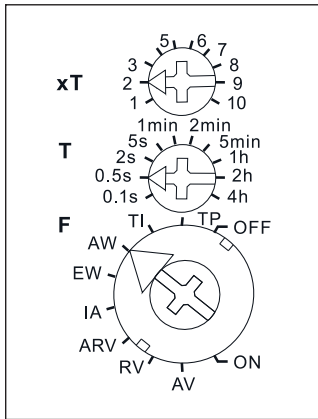

Standard setting ex works.

Typical connection

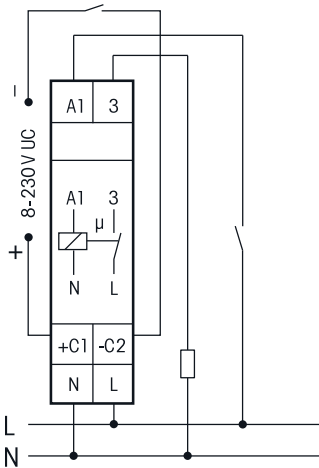

Functions F (description page 13-18)

- RV** = release delay
- AV** = operate delay
- TI** = clock generator starting with impulse
- TP** = clock generator starting with pause
- IA** = impulse-controlled operate delay
- EW** = fleeting NO contact
- AW** = fleeting NC contact
- ARV** = operate and release delay
- ON** = permanent ON
- OFF** = permanent OFF

The LED below the upper function rotary switch informs about the position of the contact during the countdown. It blinks while the contact is open and stays on as long as the contact is closed.

The time base T is selected by means of the middle, latching rotary switch **T**. Time-base figures available are 0.1 second, 0.5 seconds, 2 seconds, 5 seconds, 1 minute, 2 minutes, 5 minutes, 1 hour, 2 hours and 4 hours. The total time is obtained by multiplying the time base by the multiplier.

The multiplier xT is set on the upper, latching rotary switch **xT** and is in the range from 1 to 10. Thus, time settings can be selected in the range from 0.1 second (time base 0.1 second and multiplier 1) and 40 hours (time base 4 hours and multiplier 10).

* The maximum load can be used starting at a delay time or clock cycle of 5 minutes.
The maximum load will be reduced for shorter times as follows: up to 2 seconds 15%, up to 2 minutes 30%, up to 5 minutes 60%.

MFZ12NP-230V+UC	Analogue settable multifunction time relay, 1 NO contact 16 A	Art. No. 23100001	62,50 €/pc.
------------------------	---	--------------------------	--------------------

Manuals and documents in further languages:
http://eltako.com/redirect/MFZ12NP-230V*UC

Technical data page 13-21.
Housing for operating instructions
GBA14 page 1-49 chapter 1.

FULLY ELECTRONIC MULTIFUNCTION TIME RELAY MFZ12PMD-UC WITH 18 FUNCTIONS

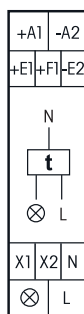

Typical connection

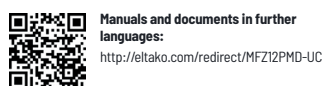
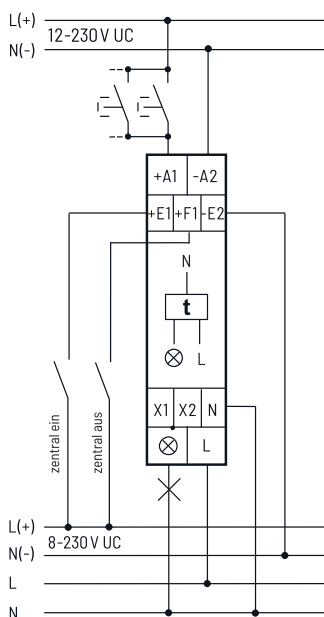

Manuals and documents in further languages:
<http://eltako.com/redirect/MFZ12PMD-UC>

MFZ12PMD-UC



Power MOSFET with almost unlimited number of circuits up to 400 W. Automatic lamp detection. Standby loss 0.3 watt only. Dim down to minimum brightness and up to maximum brightness and Soft ON / Soft OFF are also adjustable for lamp circuit.

Modular device for DIN EN 60715 TH35 rail mounting. 1 module = 18 mm wide, 58 mm deep.

Digitally adjustable and fully electronic multifunction time relay for lamps up to 400 W dependent on ventilation conditions. Dimmable 230V LED lamps and dimmable energy saving lamps (ESL) are also dependent on the lamp electronics and the dimming technology, **see technical data page 9-20.**

If **minimum brightness** is not set to 0, the circuit is not switched off but dimmed down to the set percentage.

Up to 3600 W with capacity enhancers LUD12-230V (description page 9-7) at the terminals X1 and X2.

Universal control voltage 12 to 230 V UC and additionally the universal voltage control inputs 8 to 230 V UC central ON and central OFF. The control inputs are electrically isolated from the supply voltage and switching voltage.

Zero passage switching to protect lamps.

Glow lamp current up to 5 mA starting at 110 V.

Automatic electronic overload protection and overtemperature switch-off.

Enter both the functions and the times using the two buttons MODE and SET. The functions and times are indicated digitally on an LC display. The time can be set by entering all values within the preselected time scale (0.1 to 9.9 or 1 to 99 seconds, minutes or hours). The longest time is 99 hours. This permits 600 time settings. The time(s) entered is (are) permanently displayed digitally.

Settable functions (description page 13-11): **RV** = release delay, **AV** = operate delay, **AV+** = additive operate delay, **TI** = clock generator starting with impulse, **TP** = clock generator starting with pause, **IA** = impulse-controlled operate delay, **IF** = pulse shaper, **EW** = fleeting NO contact, **AW** = fleeting NC contact, **EAW** = fleeting NO contact and fleeting NC contact, **ARV** = operate and release delay, **ARV+** = additive operate and release delay, **ES** = impulse switch, **SRV** = release-delay impulse switch, **ESV** = impulse switch with release delay and switch-off early-warning function, **ER** = relay, **ON** = permanent ON, **OFF** = permanent OFF. With TI, TP, IA, EAW, ARV and ARV+ functions, a different second time can be entered also with different time ranges.

Setting the times and functions: The LCD component to be changed is selected by pressing the MODE key. The component accessed flashes. Press the SET key to change the component accessed. This may be the function, the time ranges, time T1 or time T2 (on TI, TP, IA, EAW, ARV and ARV+ only). Pressing the MODE key terminates each input. Once the time has been set with MODE, no more components are flashing. The timing relay is now ready to operate. Press the MODE key again to restart the input cycle. All the entered parameters are retained if they are not changed using SET. 25 sec. after the last operation and if the component still flashes the input cycle is automatically terminated and the previously made changes lapse.

Setting additional parameters valid for all functions: when you press the MODE button for longer than 2 seconds, you access the submenu. Press the SET button to select the parameter you want to change. Then confirm by pressing MODE. Press SET to enter the parameter and confirm by pressing MODE. After the 'LED' submenu, you return automatically to the main menu.

MIN = Minimum brightness in OFF state settable to 0 and from 10 to 89 (%), factory setting = 0.

MAX = Maximal brightness in ON state settable from 10 to 99 (%), factory setting = 99. MAX must be at least 10 divisions above MIN.

RMP = Switch ON/OFF ramp (soft ON and soft OFF) adjustable from 0 = 10 ms to 99 = 1 s, factory setting = 0.

LED = LED+ for dimmable 230 V LED lamps which cannot be dimmed down far enough in automatic mode (trailing edge control) for design reasons and must therefore be forced by phase control. Enabled by pressing MODE; factory setting = LED without +.

Functions of the LC display: if you selected the functions ON or OFF, no time is displayed. Instead an arrow indicates either ON or OFF. In all other functions the set time(s), the function abbreviation and an arrow next to ON and OFF display the switching position. The clock symbol flashes while the set time is elapsing and the remaining time is shown.

Safety in the event of a power failure: The set parameters are stored in an EEPROM and are therefore immediately available again when the power supply is restored after a power failure.

Technical data page 13-21.
Housing for operating instructions
GBA14 page 1-49 chapter 1.

MFZ12PMD-UC	Fully electronic multifunction time relay, Power MOSFET up to 400 W	Art. No. 23001006	88,10 €/pc.
--------------------	--	--------------------------	--------------------

ANALOGUE SETTABLE MULTIFUNCTION TIME RELAY MFZ61DX-UC WITH 6 FUNCTIONS

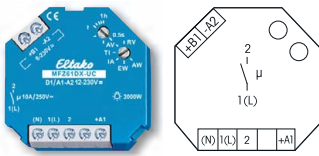

Function rotary switches

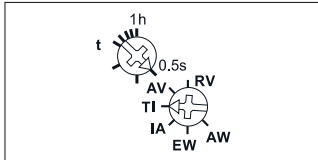

Standard setting ex factory.

Typical connection

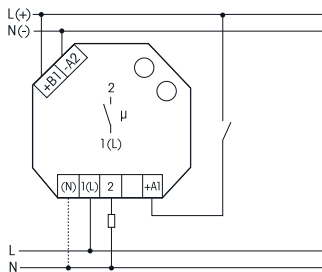

If N is connected, the zero passage switching is active.



Manuals and documents in further languages:
<http://eltako.com/redirect/MFZ61DX-UC>

Technical data page 13-21.

MFZ61DX-UC



1 NO contact potential free 10 A/250 V AC. 230 V LED lamps up to 200 W, incandescent lamps 2000 W*.
Standby loss 0.02-0.4 watt only.

Built-in device for installation.

45 mm long, 45 mm wide, 18 mm deep.

With the patented Eltako Duplex technology (DX) the normally potential-free contacts can still switch in zero passage when switching 230 V AC 50 Hz and therefore drastically reduce wear. Simply connect the neutral conductor to the terminal (N) and L to 1(L) for this. This gives an additional standby consumption of only 0.1 watt.

State-of-the-art hybrid technology combines advantages of nonwearing electronic control with high capacity of special relays.

By using a bistable relay coil power loss and heating is avoided even in the on mode.

The switched consumer may not be connected to the mains before the short automatic synchronisation after installation has terminated.

Universal control voltage input 12 to 230 V UC. Supply voltage is same as the control voltage.

Time settings between 0.5 seconds and 1 hour.

Functions F (description page 13-18)

- RV** = off delay
- AV** = operating delay
- TI** = clock generator starting with impulse
- IA** = impulse-controlled operating delay
- EW** = fleeting NO contact
- AW** = fleeting NC contact

* The maximum load can be used from a delay time or clock cycle of 5 minutes.

The maximum load is reduced for shorter times as follows: up to 2 seconds 15%, up to 2 minutes 30%, up to 5 minutes 60%.

MFZ61DX-UC	Analogue settable multifunction time relay, 1 NO contact 10 A	Art. No. 61100604	59,50 €/pc.
-------------------	--	--------------------------	--------------------

ANALOGUE SETTABLE TIME RELAY A2Z12-UC

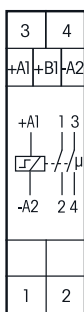

A2Z12-UC



2-stage ON-delay. 1+1 NO contact potential free 10 A/250 V AC. 230 V LED lamps up to 200 W, incandescent lamps 1000 W. Standby loss 0.4 watt only.

Modular device for DIN EN 60715 TH35 rail mounting.

1 module = 18 mm wide, 58 mm deep.

State-of-the-art hybrid technology combines advantages of nonwearing electronic control with high capacity of special relays.

Universal control voltage input 12 to 230 V UC. Supply voltage is same as the control voltage.

Contact position display with two LEDs. Very low switching noise.

By using a bistable relay coil power loss and heating is avoided even in the on mode.

The switched consumer may not be connected to the mains before the short automatic synchronisation after installation has terminated.

In case of a power failure the system is disconnected in a preset sequence.

When the control voltage is applied, the time lapse T1 starts between 0 and 60 seconds.

At the end of the time lapse, contact 1-2 closes and time lapse T2 starts between 0 and 60 seconds.

At the end of this time lapse, contact 3-4 closes. After an interval, the time lapse starts again at T1.

Function rotary switches

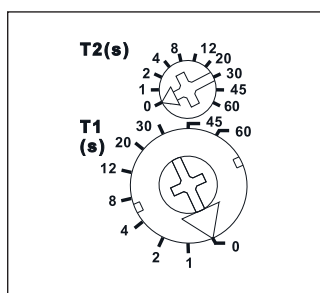

Standard setting ex factory.

Typical connection

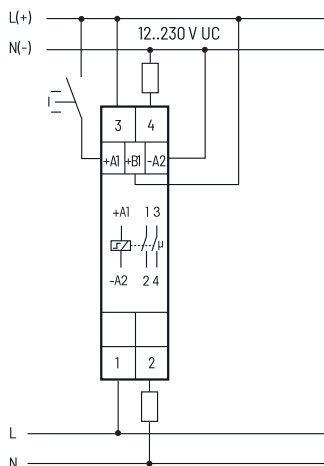

A2 = 2-stage ON-delay

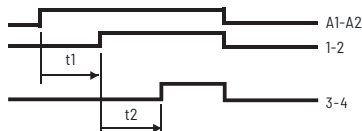

When the control voltage is applied, the time lapse T1 starts between 0 and 60 seconds. At the end of the time lapse, contact 1-2 closes and time lapse T2 starts between 0 and 60 seconds. At the end of this time lapse, contact 3-4 closes. After an interval, the time lapse starts again at T1.

A2Z12-UC	Analogue settable 2-stage ON-delay, 1+1 NO contact 10 A	Art. No. 23200302	79,80 €/pc.
-----------------	--	--------------------------	--------------------

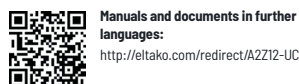

Manuals and documents in further languages:
<http://eltako.com/redirect/A2Z12-UC>

Technical data page 13-21.
Housing for operating instructions
GBA14 page 1-49 chapter 1.



Function rotary switches

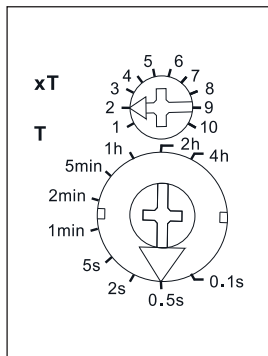

Typical connection

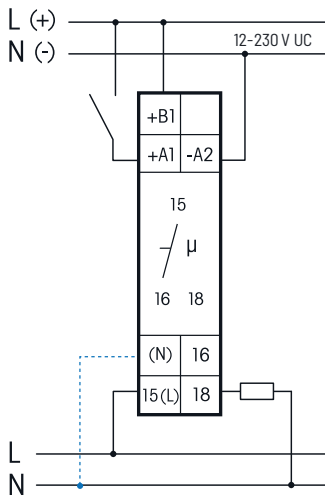

If N is connected, the zero passage switching is active.

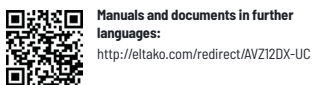

Technical data page 13-21.
Housing for operating instructions
GBA14 page 1-49 chapter 1.

AVZ12DX-UC



Operate delay, 1 CO contact potential free 10 A/250 V AC. 230 V LED lamps up to 200 W, incandescent lamps 2000 W*. Standby loss 0.02-0.4 watt only.

Modular devices for DIN-EN 60715 TH35 rail mounting.
1 module = 18 mm wide, 58 mm deep.

With the Eltako Duplex technology (DX) the normally potential-free contacts can still switch in zero passage when switching 230 V AC 50 Hz and therefore drastically reduce wear. Simply connect the neutral conductor to the terminal (N) and L to 15(L) for this. This gives an additional standby consumption of only 0.1 Watt.

Universal control voltage 12 to 230 V UC. Supply voltage same as the control voltage.
Time setting between 0.1 seconds and 40 hours.

By using a bistable relay coil power loss and heating is avoided even in the on mode.

The switched consumer may not be connected to the mains before the short automatic synchronisation after installation has terminated.

The LED below the big rotary switch indicates the contact position while time-out is in progress. It blinks while the relay contact 15-18 is open (15-16 closed), and is continuously ON as long as the relay contact 15-18 is closed (15-16 open).

The time base T is selected by means of the middle, latching rotary switch T. Time-base figures available are 0.1 seconds, 0.5 seconds, 2 seconds, 5 seconds, 1 minute, 2 minutes, 5 minutes, 1 hour, 2 hours and 4 hours. The total time is obtained by multiplying the timebase by the multiplier.

The multiplier xT is set on the upper, latching rotary switch xT and is in the range from 1 to 10. Thus, time settings can be selected in the range from 0.1 seconds (time base 0.1 seconds and multiplier 1) and 40 hours (time base 4 hours and multiplier 10).

* The maximum load can be used starting at a delay time or clock cycle of 5 minutes. The maximum load will be reduced for shorter times as follows: up to 2 seconds 15%, up to 2 minutes 30%, up to 5 minutes 60%.

AV = Operate delay (ON delay)



When the control voltage is applied the timing period is started; on time-out the relay contact changes to 15-18. After an interruption, the timing period is restarted.

AVZ12DX-UC	Analogue settable time relay with operate delay, 1 CO contact 10 A	Art. No. 23001302	68,00 €/pc.
-------------------	--	--------------------------	--------------------



EAW12DX-UC



Fleeting NO contact and fleeting NC contact, 1 CO contact potential free 10 A/250 V AC. 230 V LED lamps up to 200 W, incandescent lamps 2000 W*. Standby loss 0.02-0.4 watt only.

Modular devices for DIN-EN 60715 TH35 rail mounting. 1 module = 18 mm wide, 58 mm deep. Different functions can be selected by a rotary switch: fleeting NO contact (EW), fleeting NC contact (AW) or fleeting NO contact and fleeting NC contact (EAW).

With the Eltako Duplex technology (DX) the normally potential-free contacts can still switch in zero passage when switching 230 V AC 50 Hz and therefore drastically reduce wear. Simply connect the neutral conductor to the terminal (N) and L to 15(L) for this. This gives an additional standby consumption of only 0.1 Watt.

Universal control voltage 12 to 230 V UC. Supply voltage same as the control voltage. Time setting between 0.1 seconds and 40 hours.

By using a bistable relay coil power loss and heating is avoided even in the on mode.

The switched consumer may not be connected to the mains before the short automatic synchronisation after installation has terminated.

The LED below the big rotary switch indicates the contact position while time-out is in progress. It is OFF while the relay contact 15-18 is open (15-16 closed), and is continuously ON as long as the relay contact 15-18 is closed (15-16 open).

The time base T is selected by means of the middle, latching rotary switch T. Time-base figures available are 0.1 seconds, 0.5 seconds, 2 seconds, 5 seconds, 1 minute, 2 minutes, 5 minutes, 1 hour, 2 hours and 4 hours. The total time is obtained by multiplying the timebase by the multiplier.

The multiplier xT is set on the upper, latching rotary switch xT and is in the range from 1 to 10. Thus, time settings can be selected in the range from 0.1 seconds (time base 0.1 seconds and multiplier 1) and 40 hours (time base 4 hours and multiplier 10).

Function rotary switches

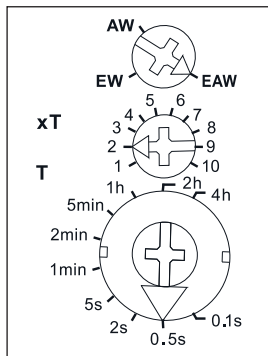

Typical connection

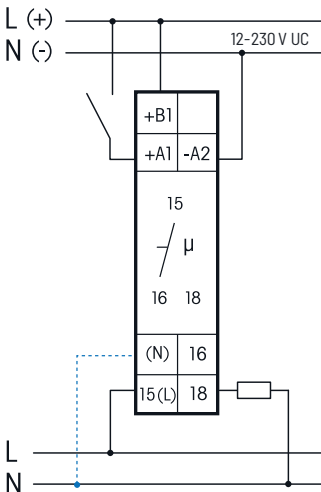

If N is connected, the zero passage switching is active.

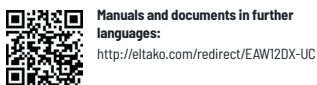

Technical data page 13-21.
Housing for operating instructions
GBA14 page 1-49 chapter 1.

* The maximum load can be used starting at a delay time or clock cycle of 5 minutes. The maximum load will be reduced for shorter times as follows: up to 2 seconds 15%, up to 2 minutes 30%, up to 5 minutes 60%.

EW = Fleeting NO contact



When the control voltage is applied the NO contact changes to 15-18 and reverts on wiping time-out. If the control voltage is removed during the wiping time the NO contact immediately reverts to 15-16 and the residual time is cancelled.

AW = Fleeting NC contact



When the control voltage is interrupted the NO contact changes to 15-18, and reverts on wiping time-out. If the control voltage is applied during the wiping time the NO contact immediately reverts to 15-16 and the residual time is cancelled.

EAW = Fleeting NO contact and fleeting NC contact



When the control voltage is applied or interrupted the relay contact changes to 15-18 and reverts after the set wiping time.

EAW12DX-UC	Analogue settable time relay with fleeting NO contact and fleeting NC contact, 1 CO contact 10 A	Art. No. 23001702	67,60 €/pc.
-------------------	--	--------------------------	--------------------

13-12

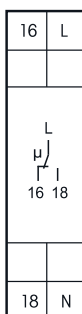

PTN12-230V



Test pushbutton for emergency lighting systems with its own battery supply. 1 CO contact 16 A/250 V AC. 230 V LED lamps up to 200 W, incandescent lamps 2300 W. Off-delay settable between 10 and 180 minutes. Only 0.5 watt standby loss.

Modular device for DIN-EN 60715 TH35 rail mounting. 1 module = 18 mm wide, 58 mm deep.
 Supply voltage 230 V, 50/60 Hz.
 Off-delay 10, 20, 30, 40, 50, 60, 90, 120, 150 and 180 minutes settable with rotary switch.
 When the supply voltage is applied, the green LED lights up.
 For further informations see the operating instructions.

Function rotary switch

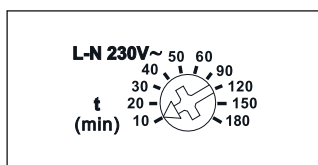

Standard setting ex works.



Manuals and documents in further languages:
<http://eltako.com/redirect/PTN12-230V>

Technical data page 13-21.
 Housing for operating instructions
 GBA14 page 1-49 chapter 1.

Typical connections

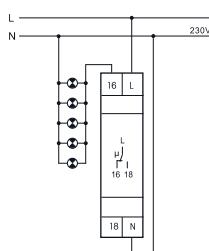

Direct control of the emergency light systems $I \leq 16$ A
 ⚡ Emergency light systems with own battery supply

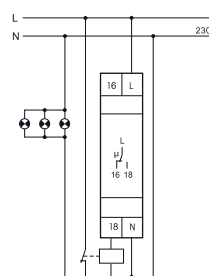

Control of emergency light systems via electric contactor $I > 16$ A
 ⚡ Emergency light systems with own battery supply

PTN12-230V	Test pushbutton for emergency lighting systems with off-delay, 1 CO contact 16 A	Art. No. 23001802	64,50 €/pc.
-------------------	--	--------------------------	--------------------

ANALOGUE SETTABLE TIME RELAY WITH RELEASE DELAY RVZ12DX-UC



RVZ12DX-UC



Release delay, 1 CO contact potential free 10 A/250 V AC. 230 V LED lamps up to 200 W, incandescent lamps 2000 W*. Standby loss 0.02-0.4 watt only.

Modular devices for DIN-EN 60715 TH35 rail mounting.
1 module = 18 mm wide, 58 mm deep.

With the Eltako Duplex technology (DX) the normally potential-free contacts can still switch in zero passage when switching 230 V AC 50 Hz and therefore drastically reduce wear. Simply connect the neutral conductor to the terminal (N) and L to 15(L) for this. This gives an additional standby consumption of only 0.1 Watt.

Universal control voltage 12 to 230 V UC. Supply voltage same as the control voltage.
Time setting between 0.1 seconds and 40 hours.

By using a bistable relay coil power loss and heating is avoided even in the on mode.

The switched consumer may not be connected to the mains before the short automatic synchronisation after installation has terminated.

The LED below the big rotary switch indicates the contact position while time-out is in progress. It is OFF while the relay contact 15-18 is open (15-16 closed), and is continuously ON as long as the relay contact 15-18 is closed (15-16 open).

The time base T is selected by means of the middle, latching rotary switch T. Time-base figures available are 0.1 seconds, 0.5 seconds, 2 seconds, 5 seconds, 1 minute, 2 minutes, 5 minutes, 1 hour, 2 hours and 4 hours. The total time is obtained by multiplying the timebase by the multiplier.

The multiplier xT is set on the upper, latching rotary switch xT and is in the range from 1 to 10. Thus, time settings can be selected in the range from 0.1 seconds (time base 0.1 seconds and multiplier 1) and 40 hours (time base 4 hours and multiplier 10).

Function rotary switches

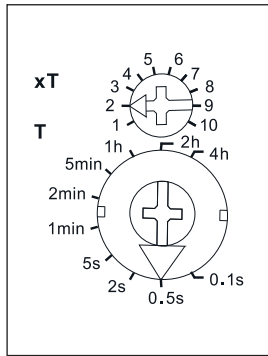

Typical connection

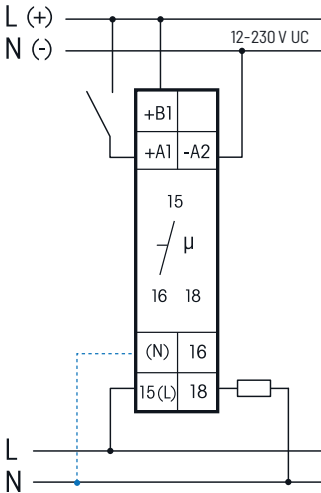

* The maximum load can be used starting at a delay time or clock cycle of 5 minutes. The maximum load will be reduced for shorter times as follows: up to 2 seconds 15%, up to 2 minutes 30%, up to 5 minutes 60%.

RV = Release delay (OFF delay)



When the control voltage is applied the relay contact switches to 15-18. When the control voltage is interrupted the timing period is started; on time-out the relay contact returns to normal position. Resettable during the timing period.

RVZ12DX-UC	Analogue settable time relay with release delay, 1 CO contact 10 A	Art. No. 23001202	67,50 €/pc.
-------------------	--	--------------------------	--------------------

If N is connected, the zero passage switching is active.

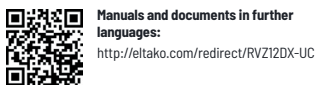

Technical data page 13-21.
Housing for operating instructions
GBA14 page 1-49 chapter 1.

13-14

ANALOGUE SETTABLE TIME RELAY WITH CLOCK GENERATOR STARTING WITH IMPULSE TGI12DX-UC



Function rotary switches

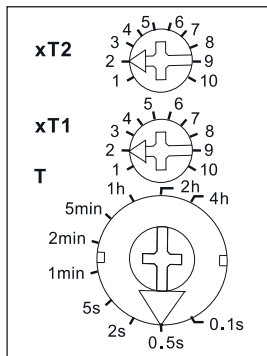

Typical connection

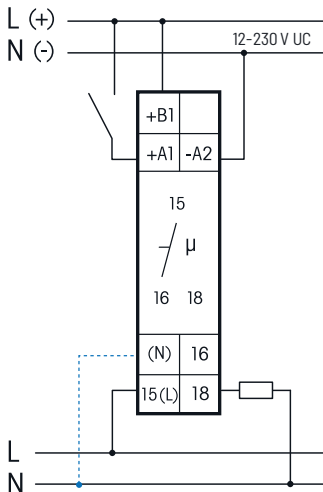

If N is connected, the zero passage switching is active.



Manuals and documents in further languages:
<http://eltako.com/redirect/TGI12DX-UC>

Technical data page 13-21.
Housing for operating instructions
GBA14 page 1-49 chapter 1.

TGI12DX-UC



Clock generator starting with impulse, 1 CO contact potential free 10 A/250 V AC. 230 V LED lamps up to 200 W, incandescent lamps 2000 W*. Standby loss 0.02-0.4 watt only.

Modular devices for DIN-EN 60715 TH35 rail mounting.

1 module = 18 mm wide, 58 mm deep.

T1 and T2 can be set separately by a second multiplier while the time base remains the same.

With the Eltako Duplex technology (DX) the normally potential-free contacts can still switch in zero passage when switching 230 V AC 50 Hz and therefore drastically reduce wear. Simply connect the neutral conductor to the terminal (N) and L to 15(L) for this. This gives an additional standby consumption of only 0.1 Watt.

Universal control voltage 12 to 230 V UC. Supply voltage same as the control voltage.

Time setting between 0.1 seconds and 40 hours.

By using a bistable relay coil power loss and heating is avoided even in the on mode.

The switched consumer may not be connected to the mains before the short automatic synchronisation after installation has terminated.

The LED below the big rotary switch indicates the contact position while time-out is in progress. It blinks while the relay contact 15-18 is open (15-16 closed), and is continuously ON as long as the relay contact 15-18 is closed (15-16 open).

The time base T is selected by means of the middle, latching rotary switch T. Time-base figures available are 0.1 seconds, 0.5 seconds, 2 seconds, 5 seconds, 1 minute, 2 minutes, 5 minutes, 1 hour, 2 hours and 4 hours. The total time is obtained by multiplying the timebase by the multiplier.

The multiplier xT is set on the upper, latching rotary switch xT and is in the range from 1 to 10. Thus, time settings can be selected in the range from 0.1 seconds (time base 0.1 seconds and multiplier 1) and 40 hours (time base 4 hours and multiplier 10).

* The maximum load can be used starting at a delay time or clock cycle of 5 minutes. The maximum load will be reduced for shorter times as follows: up to 2 seconds 15%, up to 2 minutes 30%, up to 5 minutes 60%.

T1 = Clock generator starting with impulse (flasher relay)

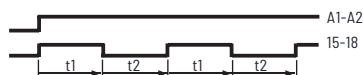

As long as the control voltage is applied the relay contact opens and closes.

Both times can be set separately (identical time base, but additional multiplier).

When the control voltage is applied the relay contact immediately changes to 15-18.

TGI12DX-UC	Analogue settable time relay with clock generator, 1 CO contact 10 A	Art. No. 23001402	67,60 €/pc.
-------------------	--	--------------------------	--------------------

2-CHANNEL TIMER WITH DISPLAY AND BLUETOOTH SU12DBT/1+1-UC WITH APP ELTAKO CONNECT

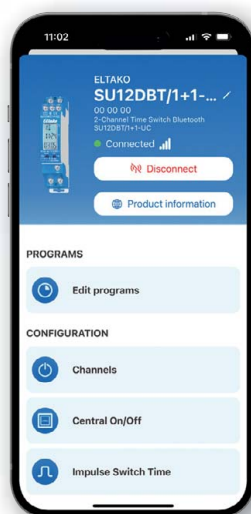

Eltako Connect app

<http://eltako.com/redirect/eltako-connect>



Manuals and documents in further languages:
http://eltako.com/redirect/SU12DBT*1+1-UC

Technical data page 13-21.
Housing for operating instructions
GBA14 page 1-49 chapter 1.

SU12DBT/1+1-UC



2-channel timer with display, Bluetooth and Eltako Connect app. Channel 1 with 1 potential-free NO contact 16 A/250 V AC and DX. Channel 2 with 1 potential-free OptoMOS semiconductor output 50 mA/12..230 V UC e.g. to control an electronic relay (ER) or a group impulse switch (EGS). With display lighting and astro function. Standby loss only 0.1-0.3 watts. Supply and control voltage for central control 12 to 230 V UC.

Modular device for DIN-EN 60715 TH35 rail mounting.

1 module = 18 mm wide, 58 mm deep.

With the patented Eltako duplex technology (DX), the normally potential-free contact 1 can still switch at zero crossing when switching 230 V/50 Hz AC voltage and thus drastically reduce wear. To achieve this, simply connect the N conductor to the terminal (N) and L to 1(L). This results in an additional standby consumption of only 0.1 watt.

Up to 60 timer memory locations are freely assigned to the channels. With date and automatic summer/winter time changeover. Ca. 7 days power reserve without battery.

Each memory location can be assigned with the astro function (automatic switching after sunrise or sun-down), the switch on/off time or a pulsed switching time (which triggers an impulse of 2 seconds). The astro switch on/off time can be changed up to ± 2 hours. A time lag of up to ± 2 hours influenced by the solstices can be entered additionally. With control input (+A1) for central control ON or OFF with priority.

The timer is set either via Bluetooth with the app or with the MODE and SET buttons, a button lock is possible.

The display lighting is switched on by pressing MODE or SET for the first time.

20 seconds after you last press MODE or SET, the program returns automatically to normal display and the display illumination goes off.

Connect the timer to the app:

Press SET, the display shows **BLE** (Bluetooth) and the ID of the timer. The connection to the app can now be established (delivery state **PIN 123123**).

Scan the QR code on the operating instructions, the app guides you through the learning process. After the connection to the app has been established, **BLE+** appears in the display. The MODE and SET buttons are now locked. After 20 minutes without interacting with the timer, the connection is automatically disconnected.

Change PIN: The PIN for the Bluetooth connection can be changed in the app under the **Device PIN** entry.

Bluetooth reset (delete any changed PIN): The connection to the app must be disconnected. Press MODE and SET simultaneously for 2 seconds, RES flashes in the display. Now press SET for 2 seconds, BLE appears in the display. If you confirm with SET, the **BLE** reset is carried out, the PIN is deleted and the delivery status is restored.

Set the timer with the MODE and SET buttons:

Set language: Every time the power supply is applied, press SET within 10 seconds to set the language and press MODE to confirm. D = German, GB = English, F = French, IT = Italian and ES = Spanish. The normal display then appears: weekday, time, day and month.

Rapid scroll: In the following settings, the numerals scroll rapidly when you press and hold down Enter. Release then press and hold down to change the scroll direction.

Set clock: Press MODE then at PRG (program) press SET to search for the **CLK function**. Press MODE to set. In H, press SET to select the hour and press MODE to confirm. In M proceed in the same way to set the minute.

Set date: Press MODE then at PRG press SET to search for the **DAT function**. Press MODE to select. At Y, press SET to select the year and press MODE to confirm. Proceed in the same way at M to set the month and at D to set the day. The last setting in the sequence is MO (weekday) blinking. Press SET to set it and press MODE to confirm.

Further settings like **geographic position for astro function, manual switching ON or OFF, summer/winter time changeover, central control ON or OFF, random mode, keylock and entering of timer programs** are described in the operating instructions.

SU12DBT/1+1-UC	2-channel timer with display and Bluetooth	Art. No. 23200902	103,70 €/pc.
----------------	--	-------------------	--------------

2-CHANNEL TIMER WITH DISPLAY AND BLUETOOTH S2U12DBT-UC WITH APP ELTAKO CONNECT



+B1	-A2	4(L)	6
		5	(N)
+E1	+F1	-E2	(N)
		1(L)	3

S2U12DBT-UC



2-channel timer with display, Bluetooth and Eltako Connect app. 1+1 CO contact potential free 10 A/250 V AC, with DX technology. With display lighting and astro function. Standby loss only 0.1-0.3 watts. Supply voltage 12..230 V UC. Central ON and central OFF control inputs for 8..230 V UC, galvanically isolated from the supply voltage and switching voltage.

Modular device for DIN-EN 60715 TH35 rail mounting. 2 modules = 36 mm wide, 58 mm deep.

With the patented Eltako Duplex technology (DX) the normally potential-free contacts can still switch in zero passage when switching 230 V AC 50 Hz and therefore drastically reduce wear. Simply connect the neutral conductor to the terminal (N) and L to 1(L) and/or 4(L) for this. This results in an additional standby consumption of only 0.1 watt.

Up to 60 timer memory locations are freely assigned to the channels. With date and automatic summer/winter time changeover. Ca. 7 days power reserve without battery. Each memory location can be assigned with the astro function (automatic switching after sunrise or sunset), the switch on/off time or a pulsed switching time (which triggers an impulse of 2 seconds). The astro switch on/off time can be changed up to ± 2 hours. A time lag of up to ± 2 hours influenced by the solstices can be entered additionally.

Central control ON (terminals +E1/-E2) or OFF (terminals +F1/-E2) with priority in ZEA operation (automatic with central control).

The timer is set either via Bluetooth with the app or with the MODE and SET buttons, a button lock is possible.

The display lighting is switched on by pressing MODE or SET for the first time.

20 seconds after you last press MODE or SET, the program returns automatically to normal display and the display illumination goes off.

Connect the timer to the app:

Press SET, the display shows **BLE** (Bluetooth) and the ID of the timer. The connection to the app can now be established (delivery state **PIN 123123**).

Scan the QR code on the operating instructions, the app guides you through the learning process. After the connection to the app has been established, **BLE+** appears in the display. The MODE and SET buttons are now locked. After 20 minutes without interacting with the timer, the connection is automatically disconnected.

Change PIN: The PIN for the Bluetooth connection can be changed in the app under the **Device PIN** entry.

Bluetooth reset (delete any changed PIN): The connection to the app must be disconnected. Press MODE and SET simultaneously for 2 seconds, RES flashes in the display. Now press SET for 2 seconds, BLE appears in the display. If you confirm with SET, the **BLE** reset is carried out, the PIN is deleted and the delivery status is restored.

Set the timer with the MODE and SET buttons:

Set language: Every time the power supply is applied, press SET within 10 seconds to set the language and press MODE to confirm. D = German, GB = English, F = French, IT = Italian and ES = Spanish. The normal display then appears: weekday, time, day and month.

Rapid scroll: In the following settings, the numerals scroll rapidly when you press and hold down Enter. Release then press and hold down to change the scroll direction.

Set clock: Press MODE then at PRG (program) press SET to search for the **CLK function**. Press MODE to set. In H, press SET to select the hour and press MODE to confirm. In M proceed in the same way to set the minute.

Set date: Press MODE then at PRG press SET to search for the **DAT function**. Press MODE to select. At Y, press SET to select the year and press MODE to confirm. Proceed in the same way at M to set the month and at D to set the day. The last setting in the sequence is MO (weekday) blinking. Press SET to set it and press MODE to confirm.

Further settings like **geographic position for astro function, manual switching ON or OFF, summer/winter time changeover, central control ON or OFF, random mode, keylock and entering of timer programs** are described in the operating instructions.

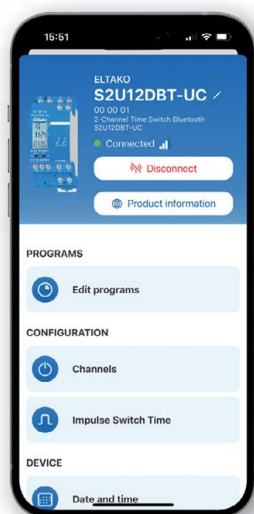

Eltako Connect app

<http://eltako.com/redirect/eltako-connect>



Manuals and documents in further languages:
<http://eltako.com/redirect/S2U12DBT-UC>

Technical data page 13-21.
Housing for operating instructions
GBA14 page 1-49 chapter 1.

S2U12DBT-UC	2-channel timer with display and Bluetooth	Art. No. 23002903	113,10 €/pc.
-------------	--	-------------------	--------------

OUTDOOR SOCKET TIMER WITH BLUETOOTH ASSU-BT/230V

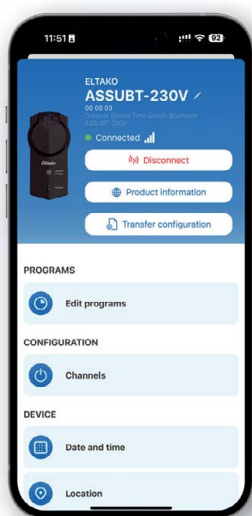

Eltako Connect app

<http://eltako.com/redirect/eltako-connect>

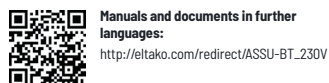

Manuals and documents in further languages:
http://eltako.com/redirect/ASSU-BT_230V

ASSU-BT/230V



1-channel timer with Bluetooth and Eltako Connect app. 1 NO contact not potential free 16 A/250 V AC, 230 V LED lamps and ESL up to 400 W, incandescent lamps 2300 W. 116x56x46 mm (measurements without plug), black. Suitable for both indoors and outdoors, IP44 (splash-proof). With 'astro' function. Only 0.3 watt standby loss.

German socket (Type F), with increased shock protection.

Supply and switching voltage 230 V.

Zero passage switching.

Bistable relay to prevent coil power loss and the associated heat generation in switched state.

Up to 60 timer memory locations are freely assigned to the channels. With date and automatic summer/winter time changeover. Ca. 7 days power reserve without battery.

Each memory location can be assigned with the astro function (automatic switching after sunrise or sundown) or the switch on/off time. The astro switch on/off time can be changed up to ± 2 hours.

A time lag of up to ± 2 hours influenced by the solstices can be entered additionally.

The timer is set via Bluetooth with the app.

Connect the timer to the app:

Press the button on the front for 5 seconds, the blue LED flashes. The connection to the app can now be established (delivery state **PIN 123123**). The flashing of the blue LED signals readiness for coupling, this ends automatically after 3 minutes, but can be ended manually by pressing a button > 5 seconds. Scan the QR code on the operating instructions, the app guides you through the teaching-in process. After the connection to the app has been established, the blue LED lights up continuously. If the connection is not disconnected via the app, it will be automatically disconnected after 20 minutes of no interaction with the app. After separating the connection via the app, the timer again signals its readiness for coupling and the blue LED flashes.

Change PIN: The PIN for the Bluetooth connection can be changed in the app under the **Device PIN** entry.

Bluetooth reset (delete any changed PIN): Briefly tap the button on the front 8 times or unplug and plug in the adapter plug 8 times within 40 seconds. The blue LED flashes.

Setting the timer via the Eltako Connect app:

Edit programs: creation, editing and activation/deactivation of time and astro programs.

Channel configuration: choose between AUTO, On or Off function. Random mode: when random mode is switched on, all switching times of all channels are randomly shifted by up to 15 minutes. Switch-on times to earlier and switch-off times to later.

Time shift solstice: setting a time shift of up to ± 2 hours at the summer solstice and at the winter solstice.

Date and time: the date, time, time zone and summer/winter time can be set manually or automatically.

Location: manual or automatic entry of the location possible.

Bluetooth: activation of permanent visibility possible. By activating permanent visibility, Bluetooth remains active on the timer and does not have to be activated manually before the connection is established.

Factory settings: choose between deleting all programs, resetting the Bluetooth settings and resetting to factory settings.

Operate the timer with the button on the front:

Manual switching: you can always switch on and off manually by briefly pressing the button.

Switching the AUTO function on and off: The AUTO function can be switched on and off by pressing the button > 2 seconds but < 5 seconds. If the button is pressed for 2 seconds, the green LED lights up briefly, then when it is released, the green LED signals whether the AUTO function is on or off.

If the green LED lights up for 0.3 seconds, the AUTO function is deactivated, set time and Astro programs are not executed.

If the green LED lights up for 2 seconds, the AUTO function is activated, the time switch switches according to the time and astro programs.

ASSU-BT/230V	Outdoor socket timer with Bluetooth, 1 NO contact 16A	Art. No. 30000660	101,80 €/pc.
---------------------	--	--------------------------	---------------------

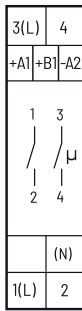

S2U12DDX-UC



2-channel timer. 1+1 NO contacts potential free 16 A/250 V AC. 230 V LED lamps up to 600 W, incandescent lamps 2000 W. With 'astro' function. Only 0.03–0.4 watt standby loss. With display backlighting.

Modular device for DIN-EN 60715 TH35 rail mounting. 1 module = 18mm wide, 58mm deep.

Patented Eltako Duplex technology (DX) allows you to switch normally potential free contacts in zero passage switching when 230 V A/C voltage 50 Hz is switched. This drastically reduces wear. To achieve this, simply connect the N conductor to the terminal (N) and L to 1(L) and/or 3(L). This results in an additional standby consumption of only 0.1 watt.

In the ON state, the use of bistable relays causes no coil power loss or heating. Up to 60 timer memory locations are freely assigned to the channels. With date and automatic summer/winter time changeover. Ca. 7 days power reserve without battery. Each memory location can be assigned with the astro function (automatic switching after sunrise or sundown), the switch on/off time or a pulsed switching time (which triggers an impulse of 2 seconds). The astro switch on/off time can be changed up to ±2 hours. A time lag of up to ±2 hours influenced by the solstices can be entered additionally.

With control input (+A1) for central control ON or OFF with priority.

Supply and control voltage for central control 12 to 230 V UC.

The timer is set using the MODE and SET buttons and a keylock function is provided.

The display illumination goes on by pressing on MODE or SET.

20 seconds after you last press MODE or SET, the program returns automatically to normal display and the display illumination goes off.

Set language: Every time the power supply is applied, press SET within 10 seconds to set the language and press MODE to confirm. D = German, GB = English, F = French, IT = Italian and ES = Spanish. The normal display then appears: weekday, time, day and month.

Rapid scroll: In the following settings, the numerals scroll rapidly when you press and hold down Enter. Release then press and hold down to change the scroll direction.

Set clock: Press MODE then at PRG (program) press SET to search for the **CLK function**. Press MODE to set. In H, press SET to select the hour and press MODE to confirm. In M proceed in the same way to set the minute.

Set date: Press MODE then at PRG press SET to search for the **DAT function**. Press MODE to select. At Y, press SET to select the year and press MODE to confirm. Proceed in the same way at M to set the month and at D to set the day. The last setting in the sequence is MO (weekday) blinking. Press SET to set it and press MODE to confirm.

Set geographic position (if astro function is required): you can find a list of German cities at the end of the operating manual. Press MODE then press SET at PRG to search for the **POS function**. Select by pressing MODE. Press SET at LAT to select the latitude. Select by pressing MODE. Repeat this procedure for LON to select the longitude and press MODE to confirm. Press SET at GMT to select the time zone and press MODE to confirm. If desired a time lag of up to ±2 hours can be entered at WS (winter solstice) and SS (summer solstice) for both channels.

Manual switching ON or OFF with priority: Press MODE and for PRG press SET to search for **function INT**. Then press MODE to select. For CH press SET to select channel 1 or 2 and press MODE to confirm. Now you can switch between AUT (automatic) and ON or OFF using SET. After confirming with MODE the shift position of the selected channel may change. If the shift position should change automatically when a time program becomes active, AUT (automatic) should be selected again. If MODE is pressed longer than 2 seconds at confirmations the change is saved and the normal display will appear.

Summer/winter time changeover: Press MODE then at PRG press SET to search for the SWT function and press MODE to select. Now press SET to switch between ON and OFF. If you select ON, changeover is automatic.

Central control ON or OFF with priority at automatic mode (AUT): Press MODE and then SET for PRG (program) to search for the **function CIA**. Press MODE to select. Then press SET to switch from CON to COF and press MODE to confirm.

Switch random mode on/off: Press MODE then at PRG press SET to search for the RND function and press MODE to select. Press SET to set to ON (RND+) or OFF (RND) and press MODE to confirm. When random mode is switched on, all switch-on time points of all channels are shifted at random by up to 15 minutes. Switch-on times are switched earlier and switch-off times are switched later.

Entering timer programs: refer to the operating instructions.

Enable keylock: Briefly press MODE and SET together and at LCK, press SET to lock. This is displayed by an arrow next to the lock symbol.

Disable keylock: Press MODE and SET together for 2 seconds and at UNL press SET to unlock.



Manuals and documents in further languages:
<http://eltako.com/redirect/S2U12DDX-UC>

S2U12DDX-UC	Digital settable timer with 2 channels, 1+1 NO contacts 16 A	Art. No. 23200901	88,70 €/pc.
--------------------	--	--------------------------	--------------------

DESCRIPTION OF FUNCTIONS OF THE MULTIFUNCTION TIME RELAYS AND TIME RELAYS

The contact 15-18 corresponds on MFZ12NP to the contact L-3. The terminals A1-A2 correspond on MFZ12NP to the terminals A1-N or C1-C2. The contact 15-18 corresponds on MFZ61DX and MFZ12-230V to the contact 1-2. The terminals A1-A2 correspond on MFZ12-230V to the terminals A1-N. The contact 15-18 corresponds on MFZ12PMD to the output \otimes .

RV = Release delay (OFF delay)



When the control voltage is applied the relay contact switches to 15-18. When the control voltage is interrupted the timing period is started; on time-out the relay contact returns to normal position. Resettable during the timing period.

AV = Operate delay (ON delay)



When the control voltage is applied the timing period is started; on time-out the relay contact changes to 15-18. After an interruption, the timing period is restarted.

TI = Clock generator starting with impulse (flasher relay)



As long as the control voltage is applied the relay contact opens and closes. On MFZ12, MFZ12DX, MFZ12NP and MFZ61DX the changeover time in both directions is identical, and is equal to the preset time. On TG112DX both times can be set separately (identical time base, but additional multiplier), on MFZ12DBT, MFZ12DDX and MFZ12PMD it is completely settable separately. When the control voltage is applied the relay contact immediately changes to 15-18.

TP = Clock generator starting with pause (flasher relay)

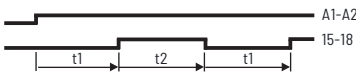

Description of function same as for TI, except that, when the control voltage is applied, the contact initially remains at 15-16 rather than changing to 15-18.

IA = Impulse-controlled operate delay

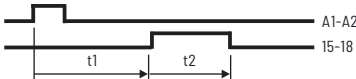

The timing period t_1 starts with a control impulse from 50ms; on time-out the relay contact changes for the timing period t_2 (for MFZ12 and MFZ12DX = 1 second, for MFZ12NP and MFZ61DX = 3 seconds) to 15-18 for 1 second (e.g. for automatic door opener). If t_1 is set to $t_1 \text{ min} = 0.1$ seconds, the IA operates as pulse shaper, when timing period t_2 elapses, independent of the duration of the control impulse (min. 150 ms).

EW = Fleeting NO contact

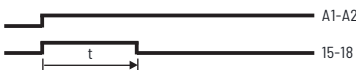

When the control voltage is applied the NO contact changes to 15-18 and reverts on wiping time-out. If the control voltage is removed during the wiping time the NO contact immediately reverts to 15-16 and the residual time is cancelled.

AW = Fleeting NC contact



When the control voltage is interrupted the NO contact changes to 15-18, and reverts on wiping time-out. If the control voltage is applied during the wiping time the NO contact immediately reverts to 15-16 and the residual time is cancelled.

ARV = Operate and release delay

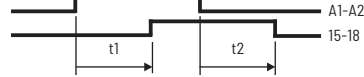

When the control voltage is applied the timing period starts; on time-out he relay contact changes to 15-18. If the control voltage is interrupted then, another timing period is started and, on time-out, the relay contact to normal position. On MFZ12, MFZ12DX and MFZ12NP this release delay is identical to the operating delay, on MFZ12DDX and MFZ12PMD it is completely settable separately. After an interruption of the operating delay, the timing period is restarted.

ER = Relais

As long as the control contact is closed the make contact reverts from 15-16 to 15-18.

EAW = Fleeting NO contact and fleeting NC contact

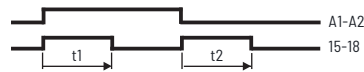

When the control voltage is applied or interrupted the relay contact changes to 15-18 and reverts after the set wiping time. On MFZ12DBT, MFZ12DDX and MFZ12PMD both times can be set separately.

ES = Impulse switch

With control impulses from 50ms the make contact switches to and fro.

IF = Pulse shaper



When the control voltage is applied the relay contact changes to 15-18 for the set time. Further control impulses are evaluated only after the set time has elapsed.

ARV+ = Additive operate and release delay

Same function as ARV, but after an interruption of the operate delay the elapsed time is stored.

ESV = Impulse switch with release delay and switch-off early-warning function

Function same as SRV. Additionally with switch-off early warning: approx. 30 sec. before time-out the lighting starts flickering 3 times at gradually shorter time intervals.

AV+ = Additive operate delay

Function same as AV. However, after an interruption the elapsed time is stored.

SRV = Release-delay impulse switch

With control impulses from 50ms the make contact switches to and fro. In the contact position 15-18, the device switches automatically to the rest position 15-16 on delay time-out.

Type	MFZ12DBT ^{b)} MFZ12DDX ^{b)} MFZ12DX ^{b)} RVZ/AVZ/TGI/ EAW12DX ^{b)}	MFZ12NP PTN12	MFZ12-230V A2Z12-UC ^{b)}	MFZ61DX ^{b)}	S2U12DDX ^{b)} SU12DBT/1+1 ^{b)} S2U12DBT ^{b)}	ASSU-BT ^{b)}
Contacts						
Contact material/contact gap	AgSnO ₂ /0.5 mm	AgSnO ₂ /0.5 mm	AgSnO ₂ /0.5 mm	AgSnO ₂ /0.5 mm	AgSnO ₂ /0.5 mm	AgSnO ₂ /0.5 mm
Spacing of control connections/contact	6 mm	3 mm	6 mm	6 mm	6 mm	—
Spacing of control connections C1-C2/contact	—	6 mm	—	—	—	—
Test voltage contact/contact	—	—	A2Z12: 4000 V	—	2000 V	—
Test voltage control connections/contact	4000 V	2000 V	4000 V	4000 V	4000 V	—
Test voltage C1-C2/contact	—	4000 V	—	—	—	—
Rated switching capacity	10 A/250 V AC	16 A/250 V AC	10 A/250 V AC	10 A/250 V AC	16 A/250 V AC S2U12DBT: 10 A/250 V AC	16 A/250 V AC
230 V LED lamps	up to 200 W ⁵⁾ I on ≤ 120 A/5 ms	up to 200 W ⁵⁾ I on ≤ 30 A/20 ms	up to 200 W ⁵⁾ I on ≤ 120 A/5 ms	up to 200 W ⁵⁾ I on ≤ 120 A/5 ms	up to 600 W ⁵⁾ I on ≤ 120 A/5 ms	up to 400 W ⁵⁾ I on ≤ 120 A/5 ms
Incandescent lamp and halogen lamp load ¹⁾ 230 V, I on ≤ 70 A/10 ms	2000 W ³⁾	2300 W ³⁾	1000 W ³⁾	2000 W ³⁾	2000 W ³⁾	2300 W ³⁾
Fluorescent lamp load with KVG* in lead-lag circuit or non compensated	1000 VA ³⁾	1000 VA ³⁾	500 VA ³⁾	1000 VA ³⁾	1000 VA ³⁾	1000 VA ³⁾
Fluorescent lamp load with KVG* shunt-compensated or with EVG*	500 VA ³⁾	500 VA ³⁾	250 VA ³⁾	500 VA ³⁾	500 VA ³⁾	500 VA ³⁾
Compact fluorescent lamps with EVG* and energy saving lamps ESL	15x7 W 10x20 W ³⁾⁴⁾⁵⁾	15x7 W 10x20 W ³⁾⁵⁾	I on ≤ 35 A/10 ms ²⁾³⁾⁵⁾	15x7 W 10x20 W ³⁾⁴⁾⁵⁾	15x7 W 10x20 W ³⁾⁴⁾⁵⁾	15x7 W 10x20 W ³⁾⁴⁾⁵⁾
Max. switching current DC: 12 V/24 V DC	8 A	—	8 A	8 A	8 A	—
Life at rated load, cos φ = 1 for incandescent lamps 1000 W at 100/h	> 10 ⁵	> 10 ⁵	> 10 ⁵	> 10 ⁵	> 10 ⁵	> 10 ⁵
Life at rated load, cos φ = 0,6 at 100/h	> 4x10 ⁴	> 4x10 ⁴	> 4x10 ⁴	> 4x10 ⁴	> 4x10 ⁴	> 4x10 ⁴
Maximum conductor cross-section (3-fold terminal)	6 mm ² (4 mm ²)	6 mm ² (4 mm ²)	6 mm ² (4 mm ²)	4 mm ²	6 mm ² (4 mm ²)	—
Two conductors of same cross-section (3-fold terminal)	2.5 mm ² (1.5 mm ²)	2.5 mm ² (1.5 mm ²)	2.5 mm ² (1.5 mm ²)	1.5 mm ²	2.5 mm ² (1.5 mm ²)	—
Screw head	slotted/crosshead, pozidriv	slotted/crosshead, pozidriv	slotted/crosshead, pozidriv	slotted/crosshead	slotted/crosshead, pozidriv	—
Type of enclosure/terminals	IP50/IP20	IP50/IP20	IP50/IP20	IP30/IP20	IP50/IP20	IP44
Electronics						
Time on	100%	100%	100%	100%	100%	100%
Max./min. temperature at mounting location	+50°C/-20°C	+50°C/-20°C	+50°C/-20°C	+50°C/-20°C	+50°C/-20°C	+50°C/-20°C
Temperature dependence	< 0.2% per °C	< 0.2% per °C	< 0.2% per °C	< 0.2% per °C	< 0.2% per °C	< 0.2% je °C
Repeat accuracy at 25°C	±0.1%	±0.1%	±0.1%	±0.1%	±0.1%	±0.1%
Control voltage dependence from 0.9 to 1.1x rated voltage	none	none	none	none	none	none
Stored energy time in the event of power failure (then total reset)	≥ 0.2 seconds	≥ 0.2 seconds	≥ 0.2 seconds	≥ 0.2 seconds	7 days	7 days
Standby loss (active power) 230 V	MFZ12DBT: 0.3 W; MFZ12DDX: 0.5 W; MFZ12DX: 0.4-0.6 W; RVZ/AVZ/TGI/ EAW12: 0.4 W	0.5 W	0.4 W	0.4 W	0.4 W S2U12DBT, SU12DBT: 0.3 W	0.3 W
Standby loss (active power) 12 V/24 V	0.02 W/0.04 W; MFZ12DDX: 0.05 W/0.1 W	—	—	0.02 W/0.04 W	0.03 W/0.06 W S2U12DBT, SU12DBT: 0.1 W	—
Control current 230 V-control input local ±20%	—	2 mA	2 mA; A2Z12: —	—	—	—
Control current universal control voltage 8/12/24/230 V (<10 s) ± 20%	0.05/0.1/ 0.2/1 mA	2/4/9/5 (100) mA	A2Z12: 0.05/ 0.1/0.2/1 mA	0.05/0.1/ 0.2/1 mA	0.04/0.05/ 0.1/1.2 mA	—
Max. parallel capacitance (approx. length) of the control leads at 230 V AC	0.2 μF (600 m)	0.01 μF (30 m) C1-C2: 0.03 μF (100 m)	0.01 μF (30 m); A2Z12: 0.2 μF (600 m)	0.2 μF (600 m)	0.2 μF (600 m)	—

* EVG = electronic ballast units; KVG = conventional ballast units³⁾ Bistable relay as relay contact. The switched consumer may not be connected to the mains before the short automatic synchronisation after installation has terminated. ¹⁾ For lamps with a load of 150 W max. ²⁾ A 40-fold inrush current must be calculated for electronic ballast devices. For steady loads of 1200 W or 600 W use the current-limiting relay SBR12 or SBR61. See chapter 14, page 14-8. ³⁾ The maximum load can be used from a delay time or clock cycle of 5 minutes. The maximum load is reduced for shorter times as follows: up to 2 seconds 15%, up to 2 minutes 30%, up to 5 minutes 60%. ⁴⁾ When using DX types close attention must be paid that zero passage switching is activated! ⁵⁾ Usually applies for dimmable 230 V LED lamps and dimmable energy saving lamps. Due to different lamp electronics and depending on the manufacturer, the maximum number of lamps may be limited, especially if the wattage of the individual lamps is very low (e.g. with 2 W LEDs).

To comply with DIN VDE 0100-443 and DIN VDE 0100-534, a Type 2 or Type 3 surge protection device (SPD) must be installed.

**FR12
NR12-001
BZR12DDX-UC
FR61**



MAINS DISCONNECTION RELAYS, OPERATING HOURS IMPULSE COUNTER, CURRENT RELAY, MAINS MONITORING RELAY AND CURRENT-LIMITING RELAYS.

Mains disconnection relays, operating hours impulse counter, current relay, mains monitoring relay and current-limiting relays

Selection table mains monitoring relays, current relays and current-limiting relays	14 - 2
Self-learning mains disconnection relay FR12-230V	14 - 3
Self-learning mains disconnection relay FR61-230V and accessory base load GLE	14 - 4
Digital adjustable operating hours impulse counter BZR12DDX-UC with alarm relay and reset	14 - 5
Current relay AR12DX-230V	14 - 6
Mains monitoring relays monitoring the rotating field NR12-001-3x230V and NR12-002-3x230V	14 - 7
Current-limiting relays capacitive SBR12-230V/240μF and SBR61-230V/120μF	14 - 8
Phase annunciator P3K12-230V and technical data	14 - 9
Typical connections mains disconnection relays	14 - 10
Questions and answers on mains disconnection relays	14 - 11

SELECTION TABLE MAINS MONITORING RELAYS, CURRENT RELAY AND CURRENT-LIMITING RELAYS



THE BODYGUARDS

Eltako mains disconnection relays switch off a monitored 230 V conductor after connected loads are switched off manually. This prevents interfering electromagnetic alternating fields.

A DC voltage with an extremely low residual ripple is used for monitoring purposes. No measurable alternating field is generated but it

is guaranteed that room lighting is detected when switched on. The monitored conductor is then switched on again.

Electronically controlled loads or supplied loads, require a high degree of monitoring effort. Here, the self-learning mains disconnection relays are ideal for such applications.

Page	14-3	14-4	14-5	14-6	14-7	14-7	14-8	14-8	14-9	
	pictograms	FR12-230V	FR61-230V	BZR12DDX-UC	AR12DX-230V	NR12-001-3x230V	NR12-002-3x230V	SBR12-230V/240µF	SBR61-230V/120µF	P3K12-230V
Modular device for mounting on DIN rail EN 60715 TH35, number of modules 18 mm each	1		1	1	1	2	1		1	
Built-in device for installation (e.g. flush-mounting box)		■						■		
Number NO contacts or CO contacts potential free (not potential free)	(1)	(1)	1W	1W	1W	2W	(1)	(1)	-	
Zero passage switching 			■ ²⁾	■ ²⁾						
Switching capacity 16 A/250 V AC	■			■			■			
Switching capacity 10 A/250 V AC		■	■		■	■		■		
Incandescent lamp load W	2300	1000	2000	2300	1600	1600	1200	600	-	
Fluorescent lamp load with EVG* and energy saving lamps W	I _{on} ≤ 70 A/ 10 ms ¹⁾	I _{on} ≤ 70 A/ 10 ms ¹⁾	150-200 ²⁾	150-200 ²⁾	I _{on} ≤ 70 A/ 10 ms ¹⁾	I _{on} ≤ 70 A/ 10 ms ¹⁾	1200	600	-	
No standby loss 							■	■	-	
Low standby loss 	■	■	■	■	■	■			■	
Adjustable operating hours counter			■							
Current relay				■						
Mains monitoring relay					■	■				
Current-limiting relay							■	■		
Mains disconnection relay	■	■								
Phase annunciator									■	

* EVG = electronic ballast units

¹⁾ A 40-fold inrush current must be expected for electronic ballast devices. Limit with SBR12 or SBR61 if applicable.

²⁾ Duplex technology: When switched with 230 V/50 Hz zero passage switching is activated if L is connected to (L) and N to (N). Then additional standby loss of only 0.1 watt.

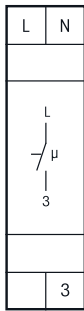

FR12-230V



1 NO contact not potential free 16 A/250 V AC. Self-learning. 230 V LED lamps up to 200 W, incandescent lamp load 2300 W. Standby loss 0.8 watt only.

Modular device for DIN EN 60715 TH35 rail mounting.
1 module = 18 mm wide and 58 mm deep.
230 V supply voltage and switching voltage.

State-of-the-art hybrid technology combines advantages of nonwearing electronic control with high capacity of special relays.

The FR12-230V mains disconnection relay disconnects the power supply once all series connected loads are turned off, thus preventing any electromagnetic interference fields from occurring.

Small loads up to 200 mA, are acceptable and, once major loads are disconnected, they do not prevent field disconnection. The limit is taught-in automatically by the FR12 using a patented method so you need not set the limit manually. Loads drawing more than 200 mA are consistently defined as loads which should cause the line power to be connected.

As long as no major load is turned on, one pole of the monitored circuit remains isolated from the mains. Neutral and earth are connected continuously to avoid acting as an aerial.

A DC voltage with an extremely low residual ripple is applied for monitoring.

Therefore, **it is prohibited to bridge the relay contact**, which would ultimately cause device failure. When a load is turned on, the mains disconnection switch connects the monitored phase after approx. 1 sec and the LED lights red.

Function of the lower rotary switch

In the function ON/P → position, the relay contact is continuously closed and field disconnection deactivated.

When turning back to position A = automatic with self-learning, the actual current value is stored as shut down value in which should be switched-off even if small consumers, such as electronic dimmers, are still available. Lighting must therefore be switched-off when 'learnin by rotary switch'.

In position A changes of connected consumers can be taught-in independently. When the outer conductor is switched-on the first time and after a power failure the FR12 automatically teaches-in again.

If a new small consumer is switched-on more than 24 hours, the total current drawn of the monitored circuit is less than 200mA, the disconnection switch is set to A mode and the light was switched-on and off occasionally, the new small consumer is taught-in and the ladder is switched-off. This can be achieved immediately after connecting of a new small consumer by briefly jumping from A to P → and back. If self-learning of the device is not desired, the rotary switch must be set to the function A 'automatic switched-off'.

Function of the upper rotary switch

The monitoring voltage can be adjusted in the range from 5 V DC to 230 V DC. Due to its low residual ripple, it generates no measurable alternating field even at 230 V DC. The higher the adjustment, the greater the number of capacitive loads detectable without switching on a base load. It can therefore be reduced until the loads are barely detectable. In many applications, even the lowest monitoring voltages are detectable.

Rotary switches

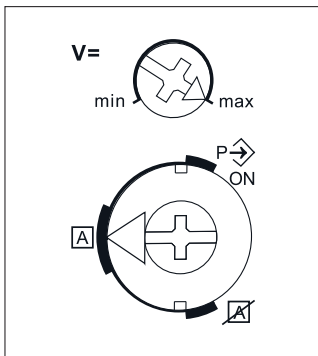

Standard setting ex factory.

Typical connection

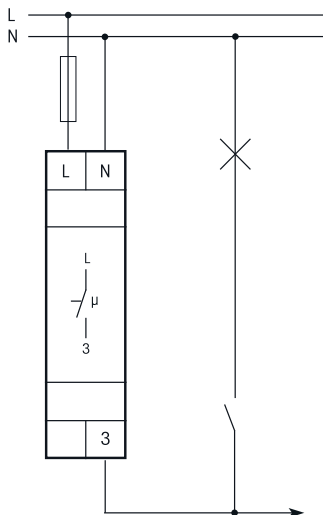

monitored circuit



Manuals and documents in further languages:
<http://eltako.com/redirect/FR12-230V>

Technical data page 14-9.
Housing for operating instructions
GBA14 page 1-49 chapter 1.

FR12-230V	Self-learning mains disconnection relay, 1 NO contact 16 A	Art. No. 22100231	82,80 €/pc.
------------------	---	--------------------------	--------------------

SELF-LEARNING MAINS DISCONNECTION RELAY FR61-230V ACCESSORY BASE LOAD GLE

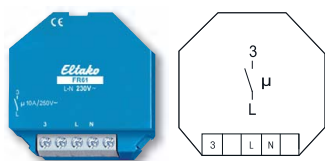

Typical connection

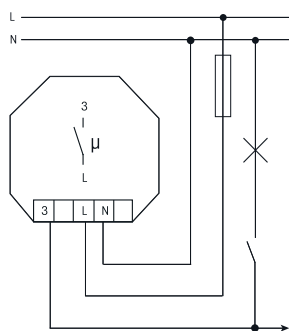

monitored circuit



Manuals and documents in further languages:
<http://eltako.com/redirect/FR61-230V>

Technical data page 14-9.



Manuals and documents in further languages:
<http://eltako.com/redirect/GLE>

FR61-230V



1 NO contact not potential free 10 A/250 V AC. 230 V LED lamps up to 200 W, incandescent lamp load 1000 W. Standby loss 0.8 watt only.

Built-in device for installation.

45 mm long, 45 mm wide, **26 mm deep.**

230 V supply voltage and switching voltage.

State-of-the-art hybrid technology combines advantages of nonwearing electronic control with high capacity of special relays.

The FR61-230V mains disconnection relay disconnects the power supply once all series connected loads are turned off, thus preventing any electromagnetic interference fields from occurring.

Small loads up to 20 mA are acceptable and, once major loads are disconnected, they do not prevent field disconnection. There is no need to manually set the limit; it is learned by the FR61. Loads drawing more than 200 mA are consistently defined as loads which should cause the line power to be connected.

As long as no major load is turned on, one pole of the monitored circuit remains isolated from the mains.

Neutral and earth are connected continuously to avoid acting as an aerial.

A DC voltage of 230 V DC with an extremely low residual ripple is applied for monitoring. Therefore, **it is prohibited to bridge the relay contact**, which would ultimately cause device failure.

When a load is turned on, the mains disconnection relay connects the phase.

If the phase is switched on for the first time and after a power failure the FR61 automatically learns in again:

At first an inrush current of 30 mA is specified. If a new small load is switched on for more than 24 hours, the total current drawn by the monitored circuit is less than 200 mA, and in the meantime the light has been switched on and off, the new load is learned in and the conductor is switched off. This learn-in mode can be realised immediately after connection of the new load by briefly switching off the MCB.

FR61-230V	Self-learning mains disconnection relay, 1 NO contact 10 A	Art. No. 61100530	76,10 €/pc.
------------------	---	--------------------------	--------------------

GLE

Accessory base load

A base load is used if loads cannot be detected due to their capacitance but are meant to switch on the line voltage. Base loads must consistently start or operate in parallel with the related load and be turned off with the latter. Higher stand by loads may affect or jam the detection of a base load. Typical applications: fluorescent lamps, dimmer circuits and electronic transformers.

GLE base load element

PTC in a small coupler with connecting leads; can be used directly in a load, a switch box or a junction box. It is not capable of keeping the mains disconnection relay in the connected state without an additional load connected.

Technical data:

Cold resistance: 3500 Ω

Starting current at 230 V: 65 mA (approx. 15 W)

Standby power after 60 seconds: 0.65 W

GLE	Base load	Art. No. 70000008	7,20 €/pc.
------------	-----------	--------------------------	-------------------

DIGITAL ADJUSTABLE OPERATING HOURS IMPULSE COUNTER BZR12DDX-UC WITH ALARM RELAY AND RESET



+B1	+AR
+A1	-A2
Field 1	
Field 2	
Field 3	
(N)	2
1(L)	3

BZR12DDX-UC



1 CO contact potential free 10 A/250 V AC. 230 V LED lamps up to 200 W, incandescent lamp load 2000 W. Standby loss 0.05-0.5 watt only.

Modular device for DIN-EN 60715 TH35 rail mounting. 1 module = 18 mm wide, 58 mm deep.

With the patented Eltako Duplex technology (DX) the normally potential-free contacts can still switch in zero passage when switching 230 V AC 50 Hz and therefore drastically reduce wear. Simply connect the neutral conductor to the terminal (N) and L to 1 (L) for this. This gives an additional standby consumption of only 0.1 watt.

The BZR12DDX is adjustable when the supply voltage 12..230V UC is applied to B1/A2:

Select the function by pressing the projecting buttons **MODE** and **SET**: Press **MODE** briefly to make the last function selected (factory setting **BST = operating hours counter**) flash in field 1. Then press **SET** to switch between **IMP = impulse counter up to 9999 impulses** and **I10 = impulse counter x 10 up to 99990 impulses**. Confirm the selected function by pressing **MODE**.

BST function = operating hours counter

Field 3 shows the accumulated **operating hours T1** up to 8760 hours = 1 year. Up to 999.9 hours with one decimal point. Field 2 can display up to 99 accumulated **operating years T2**.

Press **MODE** to activate **the alarm time AZT** when the relay contact is switched over from 1-2 to 1-3. **AZT** flashes and **SET** increments each time by 1 hour in field 3. Press and hold down to change the time rapidly. Release and then press and hold down again to change the direction. Confirm the selected time by pressing **MODE**. The + character in field 1 displays the set alarm time. **AA** flashes and **SET** activates (display **AA+**) or deactivates (display **AA**) the automatic alarm disconnection.

The operating hours are counted in field 3 as long as the control voltage (= supply voltage) is applied to A1. The display **||** moves slowly to the right in field 1.

The residual alarm time RZT in hours can be displayed by pressing **SET** briefly in field 3. Press **SET** again to switch back to the operation display.

If there is a power failure, the contact switches over from 1-2 to 1-3 and may therefore be used for an alarm signal.

When the alarm time AZT is reached, the contact switches over from 1-2 to 1-3, **SET** flashes in field 1 and the display of the elapsed alarm period starts in field 2 from 0.1 minute (m) to 99 hours (h). The contact position 1-3 is indicated by an arrow on the left in field 1.

Acknowledge the alarm: a) If the automatic alarm disconnection is activated (**AA+**), the contact 1-3 closes for only 1 second and the alarm time restarts. b) By connecting the control voltage +B1 to AR the contact switches back, if AR is disconnected from the control voltage the alarm time restarts. c) Press **SET** for 3 seconds to switch back the contact and to restart the alarm time. The operating hours counter in field 3 continues running same as for a) and b).

Reset the operating hours counter previous to the alarm signal by applying the control voltage +B1 to AR for 3 seconds or by pressing the **MODE** and **SET** buttons simultaneously for 3 seconds, confirm the **RES** display in field 1 by pressing **SET**. The counter is reset to 0. This does not change the alarm time.

Enable the keylock by pressing **MODE** and **SET** briefly and simultaneously. When you confirm the flashing display **LCK** by pressing **SET**, the buttons are locked and this is indicated by an arrow in field 1 pointing in the direction of the lock icon sticker.

Disable the keylock by pressing **MODE** and **SET** simultaneously for 2 seconds. Confirm the flashing display **UNL** by pressing **SET** to unlock.

IMP function = impulse counter and function I10 = impulse counter x 10

Field 3 shows the accumulated **impulses T1** up to 9999 (99990) impulses. Press **MODE** to **activate the alarm impulse number AIZ** when the relay contact switches over from 1-2 to 1-3. **AIZ** flashes and **SET** increments each time by 1 impulse in field 3. Press and hold down to change the impulse number rapidly. Release and then press and hold down again to change the direction. Confirm the selected impulse number by pressing **MODE** and the + character in field 1 to display the set alarm impulse number.

Every voltage impulse (identical with the supply voltage) detected at A1 increments the number of counted impulses in field 3.

The residual impulse number RIZ can be displayed after pressing **SET** briefly. **RIZ** appears in field 1 and the residual impulses until the alarm is displayed in field 3. Press **SET** again to switch back to the operation display. When the **alarm impulse number is reached**, the contact switches over from 1-2 to 1-3, **SET** flashes in field 1 and the display of other impulses up to 99 (990) starts during the alarm signal. The contact position 1-3 is indicated by an arrow on the left in field 1.

'Acknowledge alarm', 'Reset' and 'Lock/unlock setting' are identical to the **BST function = operating hours counter**.

Typical connection

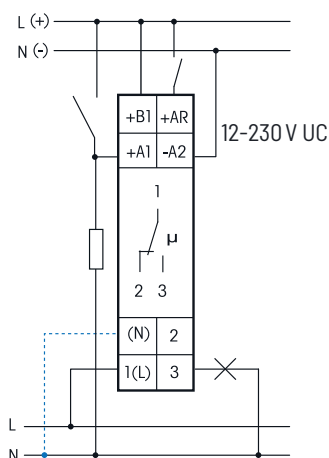

If N is connected, the zero passage switching is active.

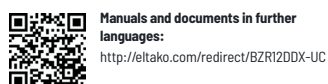

Manuals and documents in further languages:
<http://eltako.com/redirect/BZR12DDX-UC>

Technical data page 14-9.
Housing for operating instructions
GBA14 page 1-49 chapter 1.

BZR12DDX-UC	Digital adjustable operating hours impulse counter, 1 CO contact 10 A	Art. No. 22001430	69,10 €/pc.
--------------------	---	--------------------------	--------------------

CURRENT RELAY AR12DX-230V



AR12DX-230V



1 CO contact potential free 16 A/250 V AC. 230 V LED lamps up to 200 W, incandescent lamp load 2300 W. Standby loss 0.8 watt only.

Modular device for DIN 60715 TH35 rail mounting. 1 module = 18 mm wide, 58 mm deep.

With the patented Eltako Duplex technology (DX) the normally potential-free contacts can still switch in zero passage when switching 230 V AC 50 Hz and therefore drastically reduce wear. Simply connect the neutral conductor to the terminal (N) and L to 1(L) for this. This gives an additional standby consumption of only 0.1 watt.

If the contact is used for controlling switching devices which do not perform zero passage switching themselves, (N) should not be connected because the additional closing delay otherwise causes the opposite effect.

With an internal toroidal-core current transformer the single phase AC current flowing through a consumer V1 of 0.1A up to max. 32 A is compared to the setpoint. When the latter is exceeded a relay switches off a consumer V2 connected to 2 within 0.5 seconds or switches on a consumer V3 connected to 3.

Adjustment accuracy ±5%. From 25 A the relay always switches on.

State-of-the-art hybrid technology combines advantages of nonwearing electronic control with high capacity of special relays.

The basis of current A will be set with the lower rotary switch **A**.

The following basic values can be selected: 0.1 A, 0.3 A, 0.6 A, 0.9 A, 1.5 A, 1.9 A, 3.0 A and 3.2 A.

The multiplier xA will be set with the middle rotary switch **xA** and offers values between 1 and 10. So currents starting from 0.1 A (basis of current 0.1 A and multiplier 1) can be set.

OFF delay RV can be set with the upper rotary switch **RV** between 0 and 120 secs.

The hysteresis is defined as approx. 25%.

Status indication by LED.

The measuring input M1-M2 is electrically isolated from power supply L-N and make contact 1(L)-2/3.

Reference values larger than 32 A can be adapted by an external measuring transformer.

Function rotary switches

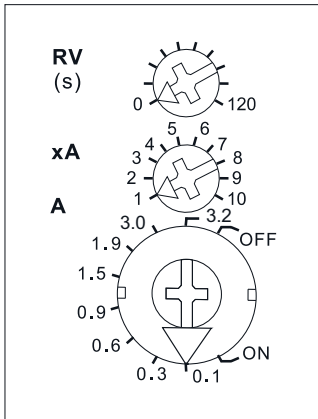

Standard setting ex factory.

Typical connection

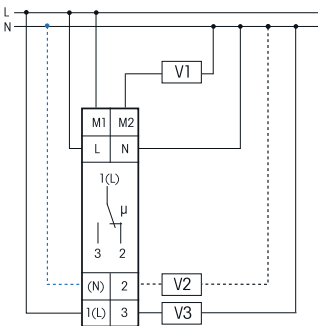

If (N) is connected, the zero passage switching is active.



Manuals and documents in further languages:
<http://eltako.com/redirect/AR12DX-230V>

Technical data page 14-9.
 Housing for operating instructions
 GBA14 page 1-49 chapter 1.

AR12DX-230V	Current relay, 1 CO contact 16 A	Art. No. 22001130	71,40 €/pc.
--------------------	----------------------------------	--------------------------	--------------------

MAINS MONITORING RELAYS MONITORING THE ROTATING FIELD NR12-001-3X230V AND NR12-002-3X230V

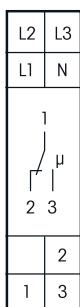

Function rotary switches

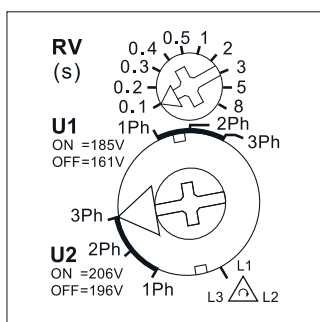

Manuals and documents in further languages:
http://eltako.com/redirect/NR12-001-3*230V

Technical data page 14-9.
 Housing for operating instructions
 GBA14 page 1-49 chapter 1.

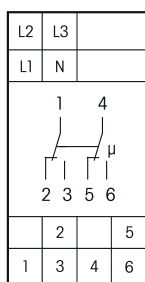

Manuals and documents in further languages:
http://eltako.com/redirect/NR12-002-3*230V

Technical data page 14-9.
 Housing for operating instructions
 GBA14 page 1-49 chapter 1.

NR12-001-3X230V



1 CO contact potential free 10 A/250 V AC. 230 V LED lamps up to 200 W, incandescent lamp load 2000 W. Standby loss 0.8 watt only.

Modular device for DIN 60715 TH35 rail mounting.
 1 module = 18 mm wide, 58 mm deep.

Designed to monitor 230 V AC voltage between 1 to 3 phase conductors and neutral and to monitor the rotating field (clockwise) in the switch positions 2 Ph and 3 Ph.

In the position \triangle only the rotating field is monitored, independent from the mains voltage.
 Supply voltage L1-N 180-250 V/50 Hz.

In case of failure of L1 the relay releases immediately without delay.

With the lower rotary switch on the front two operate voltages resp. dropout voltages can be set and the number of monitored phase conductors must be selected.

U1: 161 V dropout voltage and 185 V operate voltage.

U2: 196 V dropout voltage and 206 V operate voltage as per VDE 0100, part 718 (formerly: VDE 0108, part 1).
 Voltage applied signalled by LED. At wrong polarity or in case of a missing phase conductor the LED flashes rapidly.

Release delay **RV** settable with the upper rotary switch from 0.1 to 8 sec.

The LED flashes slowly during the release delay time period. Operate delay 0.5 sec.

Maximum fusing 16 A.

NR12-001-3x230V	Mains monitoring relay monitoring the rotating field, 1 CO contact 10 A	Art. No. 22001330	61,20 €/pc.
------------------------	---	--------------------------	--------------------

NR12-002-3X230V



2 CO contacts potential free 10 A/250 V AC. 230 V LED lamps up to 200 W, incandescent lamp load 2000 W. Standby loss 0.8 watt only.

Modular device for DIN 60715 TH35 rail mounting.
 2 modules = 36 mm wide, 58 mm deep.

All functions same as NR12-001-3x230V but with a second CO contact.

Maximum fusing 16 A.

Typical connections: 1 phase monitoring

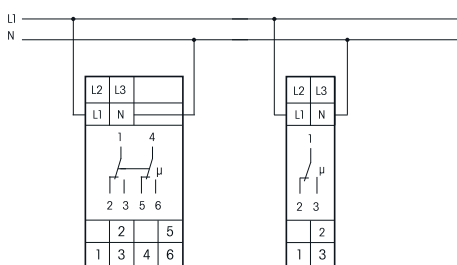

NR12-002-3x230V

NR12-001-3x230V

Typical connections: 3 phase monitoring

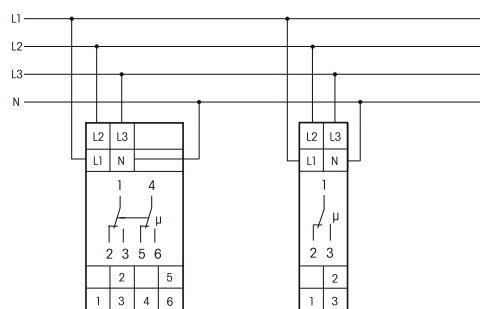

NR12-002-3x230V

NR12-001-3x230V

NR12-002-3x230V	Mains monitoring relay monitoring the rotating field, 2 CO contact 10 A	Art. No. 22002330	75,70 €/pc.
------------------------	---	--------------------------	--------------------

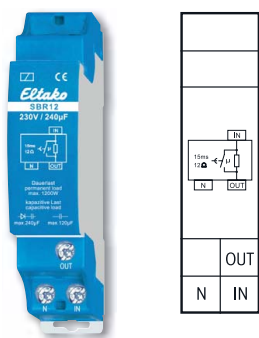

Typical connection

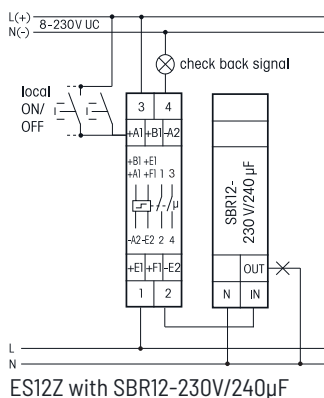

ES12Z with SBR12-230V/240µF



Manuals and documents in further languages:
http://eltako.com/redirect/SBR12-230V*240µF

SBR12-230V/240µF

1 NO contact 16 A/250 V AC. No standby loss.

Modular device for DIN 60715 TH35 rail mounting.

1 module = 18 mm wide, 58 mm deep.

Max. capacitive load 240 µF downstream of rectifier (e.g. energy saving lamps and electronic ballast) or 120 µF directly at the mains (e.g. shunt-compensated fluorescent lamps).

Limiting resistor 12 Ω, limiting period approx. 15 ms.

The starting current impulse of energy saving lamps, fluorescent lamps and compact fluorescent lamps is limited to 20 A by short-time switch-on (approx. 15 ms) of heavy-duty resistors (12 Ω).

The current-limiting relay is connected on the load side of the protected relay contact.

Permanent load max. 1200 W, max. switching frequency 600/h.

Explanation of capacitive load specification:

The specified max. capacitive load directly at the mains is the deciding factor determining shunt-compensated fluorescent lamps or conventional ballast, for example.

Here the capacitor switched in parallel to the mains is the deciding factor determining the correct dimensioning per lamp.

The specified max. capacitive load downstream of the rectifier is the deciding factor determining fluorescent lamp ballast or energy saving lamps, for example. An equivalent capacitance of 10 µF per lamp may be calculated.

SBR12-230V/240µF	Current-limiting relay capacitive, 1 NO contact 16 A	Art. No. 22100430	49,50 €/pc.
-------------------------	--	--------------------------	--------------------

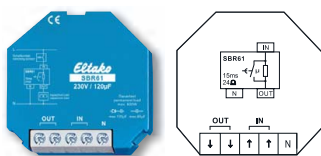

Typical connection

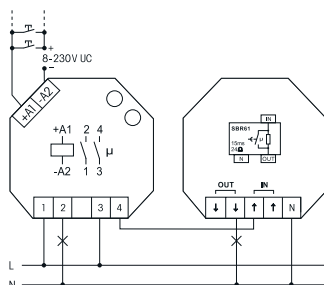

ESR61M-UC with SBR61-230V/120µF



Manuals and documents in further languages:
http://eltako.com/redirect/SBR61-230V*120µF

SBR61-230V/120µF

1 NO contact 10 A/250 V AC. No standby loss.

Built-in device for installation. 45 mm long, 45 mm wide, 18 mm deep.

Max. capacitive load 120 µF downstream of rectifier (e.g. energy saving lamps and electronic ballast) or 60 µF directly at the mains (e.g. shunt-compensated fluorescent lamps).

Limiting resistor 24 Ω, limiting period approx. 15 ms.

The starting current impulse of energy saving lamps, fluorescent lamps and compact fluorescent lamps is limited to 10 A by short-time switch on (approx. 15 ms) of heavy-duty resistors (24 Ω).

The current-limiting relay is connected on the load side of the protected relay contact.

Permanent load max. 600 W, max. switching frequency 600/h.

Explanation of capacitive load specification:

The specified max. capacitive load directly at the mains is the deciding factor determining shunt-compensated fluorescent lamps or conventional ballast, for example.

Here the capacitor switched in parallel to the mains is the deciding factor determining the correct dimensioning per lamp.

The specified max. capacitive load downstream of the rectifier is the deciding factor determining fluorescent lamp ballast or energy saving lamps, for example. An equivalent capacitance of 10 µF per lamp may be calculated.

SBR61-230V/120µF	Current-limiting relay capacitive, 1 NO contact 16 A	Art. No. 61100330	54,80 €/pc.
-------------------------	--	--------------------------	--------------------



P3K12-230V

Phase annunciator. Standby loss 0.06 watt only.

Modular device for DIN 60715 TH35 rail mounting.
 1 module = 18 mm wide, 58 mm deep.
 For visual monitoring of 1 to 3 phases 230 V.
 Indication with three red LEDs.



Manuals and documents in further languages:
<http://eltako.com/redirect/P3K12-230V>

P3K12-230V	Phase annunciator	Art. No. 24000899	38,90 €/pc.
-------------------	-------------------	--------------------------	--------------------

Type	BZR12DDX	NR12	AR12DX/FR12	FR61
Contacts				
Contact material	AgSnO ₂ /0.5 mm	AgSnO ₂ /0.5 mm	AgSnO ₂ /0.5 mm	AgSnO ₂ /0.5 mm
Spacing of control connections/contact	3 mm	>6 mm	-, AR12DX: >6 mm	-
Test voltage contact to contact	2000 V	-, NR12-002: 2000 V	-	-
Test voltage control connection to contact	-	4000 V	-, AR12DX: 4000 V	-
Rated switching capacity	10 A/250 V AC	10 A/250 V AC	16 A/250 V AC	10 A/250 V AC
230 V LED lamps	up to 200 W ⁵⁾ I on ≤ 120 A/5 ms	up to 200 W ⁵⁾ I on ≤ 30 A/20 ms	up to 200 W ⁵⁾ I on ≤ 30 A/20 ms	up to 200 W ⁵⁾ I on ≤ 30 A/20 ms
Incandescent lamp and halogen lamp load ¹⁾ 230 V, I on ≤ 70 A/10 ms	2000 W	2000 W	2300 W	1000 W
Fluorescent lamp load with KVG* in lead-lag circuit or non compensated	1000 VA	1000 VA	1000 VA	1000 VA
Fluorescent lamp load with KVG* shunt-compensated or with EVG*	500 VA	500 VA	500 VA	500 VA
Compact fluorescent lamps with EVG* and energy saving lamps ESL	15x7 W, 10x20 W ³⁾	I on ≤ 70 A/10 ms ²⁾	FR12: I on ≤ 70 A/10 ms ²⁾ AR12DX: 15x7 W, 10x20 W ³⁾	I on ≤ 70 A/10 ms ²⁾
Max. switching current DC1: 12 V/24 V DC	8 A	8 A	-	-
Life at rated load, cos φ = 1 at 100/h and incandescent lamps 1000 W at 100/h	>10 ⁵	>10 ⁵	>10 ⁵	>10 ⁵
Life at rated load, cos φ = 0.6 at 100/h	> 4x10 ⁴	> 4x10 ⁴	> 4x10 ⁴	> 4x10 ⁴
Max. operating cycles	10 ³ /h	10 ³ /h	10 ³ /h	10 ³ /h
Switching position indication/voltage indication	display	LED	LED	-
Maximum conductor cross-section	6 mm ²	6 mm ²	6 mm ²	4 mm ²
Two conductors of same cross-section	2.5 mm ²	2.5 mm ²	2.5 mm ²	1.5 mm ²
Screw head	slotted/crosshead, pozidriv	slotted/crosshead, pozidriv	slotted/crosshead, pozidriv	slotted/crosshead, pozidriv
Type of enclosure/terminals	IP50/IP20	IP50/IP20	IP50/IP20	IP30/IP20
Electronics				
Time on	100%	100%	100%	100%
Max./min. temperature at mounting location	+50°C/-20°C	+50°C/-20°C	+50°C/-20°C	+50°C/-20°C
Control voltage range	0.9 to 1.1x rated voltage	180-250 V/50-60 Hz	0.9 to 1.1x rated voltage	0.9 to 1.1x rated voltage
Stand by loss (active power) 230 V	0.5 W	0.8 W	0.8 W	0.8 W
Stand by loss (active power) 12 V ⁴⁾	0.05 W	-	-	-
Max. parallel capacitance (length) of control lead	0.06 µF (200 m)	0.06 µF (200 m)	0.06 µF (200 m)	0.06 µF (200 m)

* EVG = electronic ballast units; KVG = conventional ballast units
¹⁾ Applies to lamps with max. 150 W. ²⁾ A 40-fold inrush current must be expected for electronic ballast devices. ³⁾ When using DX types close attention must be paid that zero passage switching is activated! ⁴⁾ Standby loss at 24 V approx. two times greater than at 12 V. ⁵⁾ Usually applies for dimmable 230 V LED lamps and dimmable energy saving lamps. Due to differences in the lamps electronics, there may be a restriction on the maximum number of lamps; especially if the connected load is very low (for 5 W-LEDs).

To comply with DIN VDE 0100-443 and DIN VDE 0100-534, a Type 2 or Type 3 surge protection device (SPD) must be installed.

TYPICAL CONNECTIONS MAINS DISCONNECTION RELAYS

Standard connection mains disconnection relay

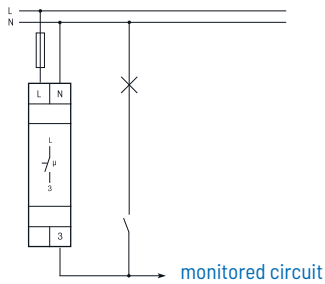

Mains disconnection relay with GLE base load element

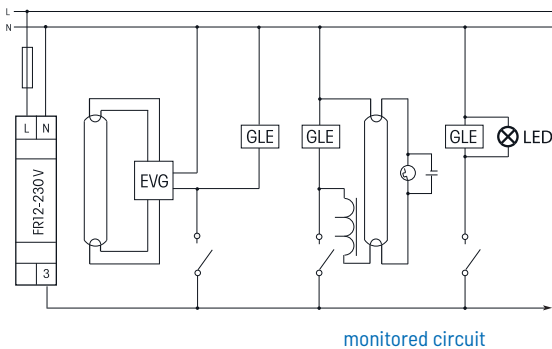

Elder rotary dimmers with phase cut-on (ON before zero crossing) for resistive and inductive loads

Can mostly be operated at $V = \max$ if no additional standby consumer is in the circuit.

Otherwise see 'Modern dimmers'.

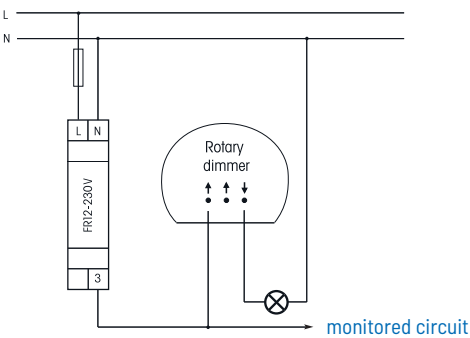

Newer rotary dimmers and rotary dimmers with phase cut control for electronic transformers cannot be used. The EUD61 universal dimmer and a button from the corresponding switch range can replace a pushbutton dimmer.

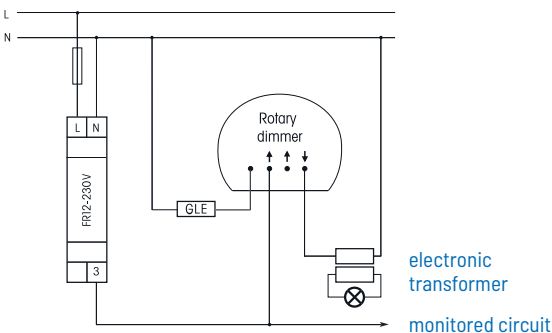

Touch dimmers and sensor dimmers

cannot be used. The universal dimmer switch EUD61 and a push-button from the associated switch product range can replace a touch dimmer.

Remote control dimmers

We recommend as remote control dimmers the impulse dimmer switch EUD12F. On these devices, terminal L is 'tapped' **ahead** of the mains disconnection relay, thus, maintaining the complete function. An integrated cut-off relay takes over the mains disconnection of the circuit. Mechanical push-buttons are connected to T1 and T2. Only a low DC voltage is impressed on the control wire. If the application of the EUD12F is not possible for reasons of installation the type EUD12NPN can be used. Here the terminal L is connected **after** the mains disconnection relay. Therefore the memory function is switched off.

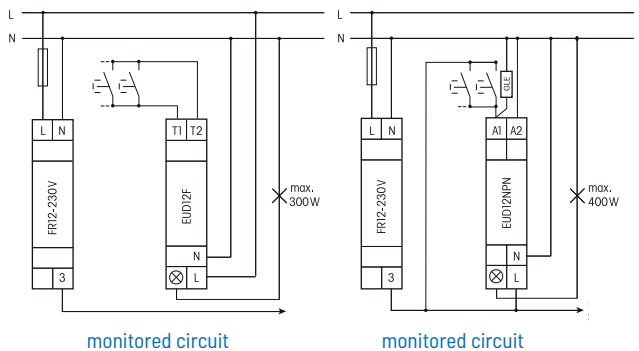

Switched-mode power supplies in consumer electronic units (e.g. TV sets) and plug-in power supply units

Only specific units or power supplies are detected and disconnected by the mains disconnection switch, even while in standby mode. Where units or power supplies in a monitored circuit are not to be disconnected these must be isolated from line power by a switched socket outlet or a plug connector so that the function of the mains disconnection switch is not affected.

Switching power supply units in the distribution box

The switching power supply units WNT15 are detected at primary switching-on from 50 V DC monitoring voltage.

At secondary switching-on of the load the full monitoring voltage is necessary.

Roller shutter control

In order to operate tube-mounted motors with electronic limit switches, it is best if the lighting is switched on to reactivate the monitored circuit before the electromechanical switch or push-button switch is operated. In case of automatic controls in monitored circuits, the mains disconnection (MD) must be inhibited for the period when the roller shutters are controlled. This can be achieved by fitting a time switch in the distributor. However, in this case, do not bridge L-3 of the mains disconnection relay under any circumstances. Instead, connect the time switch change-over contact between terminal L of the MD and the monitored circuit.

Plug-in consumers with power control

These devices (vacuum-cleaners, standard lamps with dimmer) are often not detected when switching on the mains disconnection relay. For operation of these kind of devices therefore the normal lighting must be switched on first.

Function check?

Disconnect terminal 3 with the power on. The mains disconnection relay must switch the phase on. The LED goes out.

Base load?

A base load is used if loads cannot be detected due to their capacitance but are meant to switch on the line voltage. Never connect a base load directly between the disconnecting phase and neutral.

The mains disconnection relay is clocking?

A base load device may be connected directly between the disconnecting phase and neutral. An inductive consumer (e.g. plug-in power supply) is located in the disconnecting circuit without any isolation directly downstream of the mains disconnection relay. To function correctly, the consumer must be isolated from the mains.

Dimmer operation downstream of a mains disconnection relay?

We recommend using the universal dimmer switch EUD12F or EUD12NPN, as described on page 14-10. Rotary dimmer with phase sector control for electronic transformers: only possible with additional terminal for mains disconnection devices (e.g. make Busch-Jaeger, Jung, Berker and Gira).

Touch dimmers and sensor dimmers cannot be used.

The universal dimmer switch EUD61 and a push-button from the associated switch product range can replace a touch dimmer.

Operate electronic transformers?

All electronic transformers must be switched with a base load in parallel to the primary input, as long as they are not dimmed.

Appliances with transformer power supplies

(i.e. entertainment electronic appliances, PC, etc.)?

These appliances are often switched on or off on the secondary side. The transformer power supplies are permanently connected to the mains. Devices with these features must be disconnected from the mains after operation by unplugging the mains plug or by a switchable multiple socket strip or power consumption is learnt-in and is also disconnected (up to 200 mA).

Time-controlled roller blind controls directly mounted at the windows?

These roller blind controls receive a continuous quiescent current and should not be operated downstream of a mains disconnection relay for this reason. If disconnection is not possible from the room electrical circuit, the roller blind controls must be replaced by roller blind switches.

Electronic impulse switches downstream of a mains disconnection relay?

We recommend the electronic impulse switches ESR12NP which can also connect the FR12 without an additional base load.

Electromechanical impulse switches need to be pressed a little longer until the FR12 and the lighting circuit switch on.

Fluorescent lamps or compressed fluorescent lamps (energy saving lamps) downstream of a mains disconnection relay?

Fluorescent lamps always require a base load which must be connected in parallel to the lamp.

230 V LED lamps after a mains disconnection switch?

230 V LED lamps always need a base load which must be connected in parallel to the lamp.

TLZ12
TLZ12D
TLZ61NP
NLZ12NP



15
MAKE A CONFIDENT STRIDE THROUGH THE STAIRWELL WITH ELTAKO STAIRCASE TIME SWITCHES.





Staircase time switches and off-delay timers

Selection table staircase time switches and off-delay timers	15 - 2
Staircase time switch TLZ12-8plus - The Standard	15 - 3
Staircase time switch TLZ12-8 - The Simple	15 - 4
Staircase time switch TLZ12G-230V+UC - The Noiseless	15 - 5
Digital settable staircase time switch TLZ12D-plus - The Allrounder	15 - 6
Staircase time switch TLZ12-9 for older installations	15 - 7
Staircase time switch TLZ61NP-230V	15 - 8
Staircase time switch TLZ61NP-230V+UC	15 - 9
Technical data staircase time switches	15 - 10
Off-delay timer NLZ12NP-230V+UC	15 - 11
Off-delay timer NLZ61NP-UC	15 - 12
Technical data off-delay timer	15 - 13

THE COMPLETE RANGE

From the "simple" to the "all-rounder".
Staircase light actuators for every challenge.
For 3- and 4-wire circuits.
Of course for LED, ESL and incandescent lamps.

- The simple, TLZ12-8 with noiseless electronics.
- The standard, TLZ12-8plus with switch-off warning according to DIN 18015-2 and permanent light.
- The noiseless, TLZ12G-230V + UC with solid-state relay and additional galvanically isolated universal control voltage.
- The all-rounder, TLZ12D-plus additionally with motion detector control input BM.

Page	15-3	15-4	15-5	15-6	15-7	15-8	15-9	15-11	15-12	
	pictograms	TLZ12-8plus	TLZ12-8	TLZ12G-230V+UC	TLZ12D-plus	TLZ12-9	TLZ6INP-230V	TLZ6INP-230V+UC	NLZ12NP-230V+UC	NLZ6INP-UC
Modular device for mounting on DIN rail EN 60715 TH35, number of modules 18 mm each		1	1	1	1	1			1	
Built-in device for installation (e.g. flush-mounting box)							■	■		■
230 V LED lamps (W)		up to 600	up to 100	up to 400	up to 600	up to 600	up to 600	up to 600	up to 600	
Incandescent lamp load (W)		2300	2000	400	2300	2300	2000	2000		
For energy saving lamps ESL*		■	■	■	■	■	■	■		
For 230 V LED lamps		■	■	■	■	■	■	■		
Switch-off early warning function switchable ¹⁾		■		■	■	■	■	■		
Variable time range up to		30 min	12 min	30 min	99 min	12 min	12 min	12 min	12 min	12 min
Low standby loss		■	■	■	■	■	■	■	■	■
230 V control voltage		■	■	■	■	■	■	■	■	
Universal control voltage (additionally) 8 to 230 V UC		■		■				■		■
Glow lamp current mA		50	50	50	50	50	50	50		
Double connections pushbutton and lamp		■	■	■						
Single connections below						■				
Automatic detection 3-/4-wire circuit		■	■	■	■		■	■		
3-wire circuit, without attic lighting						■				
Resettable		■	■	■	■		■	■		
Permanent light and switch-off logics with pushbutton switchable		■		■	■		■	■		
Incrementing ²⁾		■		■	■		■	■		
Separate continuous light switch		■	■	■	■	■				
Additional input for motion control					■					
With multifunction: TLZ, ESV, ES and ER		■		■	■		without ER	without ER	■	
Bistable relay		■			■	■	■	■		
Zero passage switching		■		■	■	■	■	■	■	■

* ESL = abbr. for energy saving lamps

¹⁾ As stipulated in DIN 18015-2 under 4.2 the following should be taken into account: For lighting systems in staircases, corridors, arcades or elevator areas it is recommended to use the switch off early warning function to prevent sudden darkness. If the switch-off early warning function is active, the light starts flickering approx. 30 seconds before time-out and is repeated three times at decreasing time intervals.

²⁾ Time can be extended: Within the first second after switching on or resetting the time can be extended by pressing the pushbutton repeatedly up to three times (incrementing). Each operation increments the set time once.

STAIRCASE TIME SWITCH TLZ12-8PLUS THE STANDARD

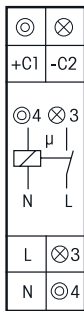

TLZ12-8plus



1 NO contact not potential free 16 A/250 V AC. 230 V LED lamps up to 600 W, energy saving lamps ESL up to 200 W, incandescent lamps up to 2300 W. Control voltage 230 V and/or 8..230 V UC. Switch-off early warning and permanent light by pushbutton switchable. Standby loss 0.7 watt only. With ESL optimisation and multifunction.

Modular device for DIN EN 60715 TH35 rail mounting.
1 module = 18 mm wide, 58 mm deep.

Zero passage switching to protect contacts and lamps.

The noiseless electronics do not even bother the sensitive ear - unlike many synchronous motors with mechanical gears.

By using a bistable relay coil power loss and heating is avoided even in the on mode.

The switched consumer may not be connected to the mains before the short automatic synchronisation after installation has terminated.

Control voltage, supply voltage and switching voltage 230 V. In addition electrically isolated universal voltage from 8 to 230 V UC. 3-wire and 4-wire circuits, resettable, with attic lighting if 4-wire circuit.

Automatic detection of the method of connection.

Glow lamp current up to 50 mA, dependent on the ignition voltage of the glow lamps.

Precise variable time range from 1 to 30 minutes, settable by minute scale.

Permanent light switch with the big rotary switch.

If the function TLZ is set, the lighting is switched on again after a power failure provided the set time has not yet elapsed.

With double connections for pushbutton and lamp in order to connect either above or below or only below.

If switch-off early warning function is switched on, the light starts flickering approx. 30 seconds before time-out and is repeated three times at decreasing time intervals.

If permanent light by pushbutton is switched on, permanent light can be switched on by pressing the pushbutton longer than 1 second. This is switched off automatically after 60 minutes or by pressing the pushbutton longer than 2 seconds.

If both switch-off early warning function and permanent light by pushbutton are switched on, the switch-off early warning function is activated before the permanent light switches off.

When energy saving lamps ESL are completely or partially switched, then set the switch-off early warning and the permanent light by pushbutton on the right hand side of the rotary switch.

If the function TLZ is selected **the time can be extended** within the first second after switching on or resetting **by pressing the pushbutton repeatedly up to three times** (incrementing). Each momentary-contact control increments the set time once.

With multifunction: The following functions can be selected optionally: **ES** (impulse switch), **ER** (relay), **ESV** (impulse switch with release delay).

If the function ESV is set the time ranges (t), which can be set with the middle rotary switch are as follows: 1 = 2 min, 2 = 5 min, 3 = 10 min, 4 = 15 min, 6 = 25 min, 8 = 35 min, 10 = 45 min, 12 = 60 min, 20 = 90 min, 30 = 120 min. In this function the impulse switch automatically disconnects after the set delay is timed out, if a manual OFF command has not been given. Switch-off early warning and permanent light by pushbutton can also be switched on in this position. Forgotten permanent light is switched off after 2 hours.

Function rotary switches

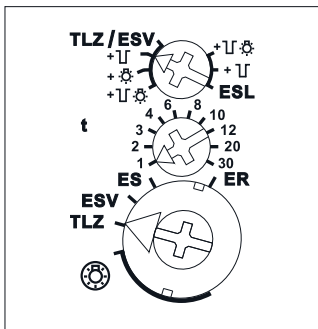

Typical connections

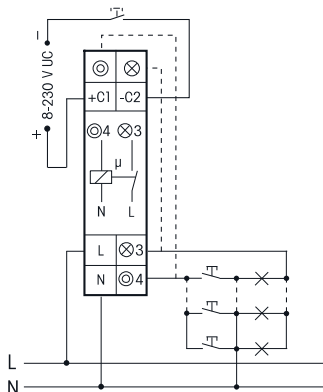

3-wire circuit, resettable.

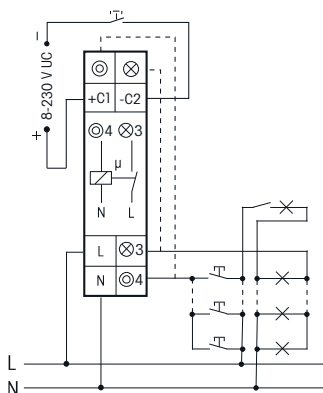

4-wire circuit with attic lighting, resettable.

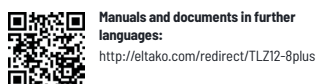

Technical data page 15-10.
Housing for operating instructions
GBA14 page 1-49 chapter 1.

Recommended retail prices excluding VAT.

TLZ12-8plus	Staircase time switch, 1 NO contact 16 A	Art. No. 23100832	57,60 €/pc.
--------------------	--	--------------------------	--------------------

STAIRCASE TIME SWITCH TLZ12-8 THE SIMPLE

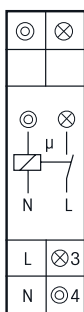

Function rotary switches

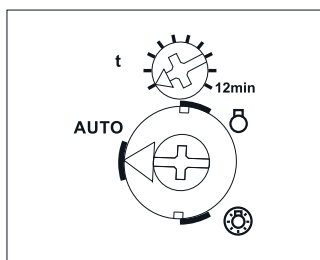

Typical connections

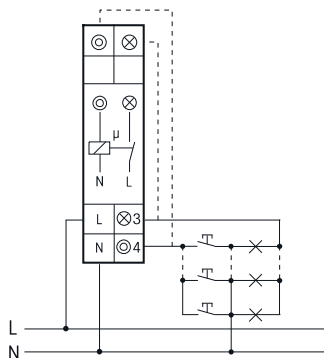

3-wire circuit, resettable.

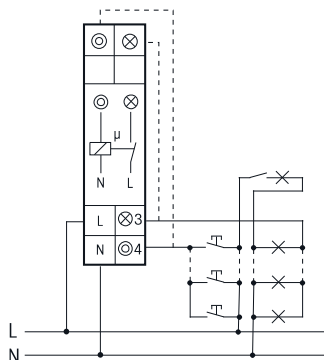

4-wire circuit with attic lighting, resettable.



Manuals and documents in further languages:
<http://eltako.com/redirect/TLZ12-8>

Technical data page 15-10.
Housing for operating instructions
GBA14 page 1-49 chapter 1.

TLZ12-8



1 NO contact not potential free 16 A/250 V AC. 230 V LED lamps and energy saving lamps ESL up to 100 W, incandescent lamps up to 2000 W. Without switch-off early warning. Standby loss 0.7 watt only.

Modular device for DIN EN 60715 TH35 rail mounting.

1 module = 18 mm wide, 58 mm deep.

The noiseless electronics do not even bother the sensitive ear - unlike many synchronous motors with mechanical gears.

230 V control voltage, supply voltage and switching voltage.

Variable time range from approx. 0.2 to 12 minutes.

Glow lamp current up to 50 mA, dependent on the ignition voltage of the glow lamps.

Own permanent light switch with the big rotary switch.

3-wire and 4-wire circuits, resettable, with attic lighting if 4-wire circuit.

Automatic detection of the method of connection.

Without switch-off early warning function and without zero passage switching.

With double connections for pushbutton and lamp in order to connect either above or below or only below.

⊖ = Function switched off

⊕ = Permanent light switched on

AUTO = The set function is active

TLZ12-8	Staircase time switch, 1 NO contact 16 A	Art. No. 23100934	44,90 €/pc.
---------	--	-------------------	-------------

**STAIRCASE TIME SWITCH TLZ12G-230V+UC
THE NOISELESS**

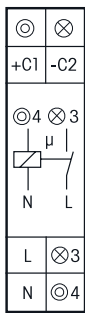

TLZ12G-230V+UC



Noiseless solid-state relay not potential-free. 230 V LED lamps and energy saving lamps ESL up to 400 W, incandescent lamps up to 400 W. Switch-off early warning and pushbutton permanent light switchable. Standby loss 0.4 watt only. With ESL optimisation and multifunction.

Modular device for DIN-EN 60715 TH35 rail mounting.
1 module = 18 mm wide, 58 mm deep.

Zero passage switching to protect lamps.

The noiseless electronics and zero passage switching do not even bother the sensitive ear – unlike many synchronous motors with mechanical gears.

Control, supply and switching voltage 230 V. Additionally 8 to 230 V UC electrically isolated universal control voltage. 3-wire and 4-wire circuits, resettable, with attic lighting if 4-wire circuit. **Automatic detection of the method of connection.**

Glow lamp current up to 50 mA, dependent on the ignition voltage of the glow lamps.

Precise variable time range from 1 to 30 minutes, settable by minute scale.

Permanent light switch with the big rotary switch.

If the function TLZ is set, the lighting is switched on again after a power failure provided the set time has not yet elapsed.

With double connections for pushbutton and lamp in order to connect either above or below or only below. **If switch-off early warning function is switched on** the light starts flickering approx. 30 seconds before time-out and is repeated three times at decreasing time intervals.

If pushbutton permanent light is switched on permanent light can be switched on by pressing pushbutton longer than 1 second. This is switched off automatically after 60 minutes or by pressing pushbutton longer than 2 seconds.

If both switch-off early warning function and permanent light pushbutton are switched on, the switch-off early warning function is activated before the permanent light switches off.

When energy saving lamps ESL are completely or partially switched, then set the switch-off early warning and the pushbutton permanent light on the right hand side of the rotary switch.

If the function TLZ is selected **the time can be extended** within the first second after switching on or resetting **by pressing the pushbutton repeatedly up to three times** (incrementing). Each momentary-contact control increments the set time once.

With multifunction: the following functions can be selected optionally: ES (impulse switch), ER (relay), ESV (impulse switch with release delay).

If the function ESV is set the time ranges (t) which can be set with the middle rotary switch are as follows: 1 = 2 min, 2 = 5 min, 3 = 10 min, 4 = 15 min, 6 = 25 min, 8 = 35 min, 10 = 45 min, 12 = 60 min, 20 = 90 min, 30 = 120 min. In this function the impulse switch automatically disconnects after the set delay is timed out, if a manual OFF command has not been given. Switch-off early warning and pushbutton permanent light can be switched on additionally in this position as well. Forgotten permanent light is switched off after 2 hours.

Function rotary switches

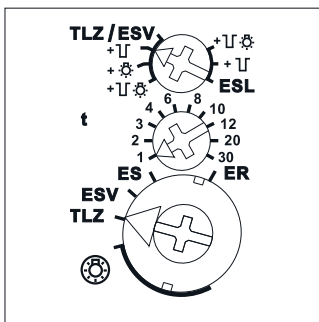

Typical connections

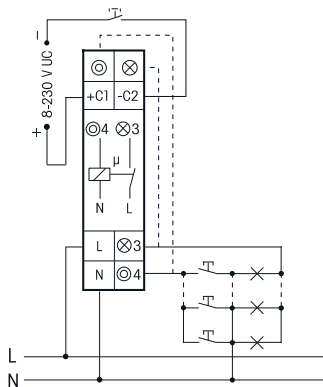

3-wire circuit, resettable.

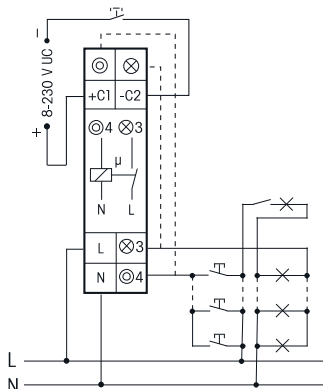

4-wire circuit with attic lighting, resettable.

- ⏏ = Switch-off early warning function
- ⏏⏏ = Permanent light by pushbutton
- ⏏⏏⏏ = Switch-off early warning function and permanent light by pushbutton
- ⏏⏏⏏⏏ = Permanent light switched on (all click-stop positions)
- TLZ/ESV/ES/ER = The set function is active

TLZ12G-230V+UC	Staircase time switch, noiseless, solid-state relay 400 W	Art. No. 23100831	63,80 €/pc.
-----------------------	---	--------------------------	--------------------

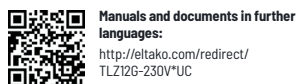

Technical data page 15-10.
Housing for operating instructions
GBA14 page 1-49 chapter 1.

Recommended retail prices excluding VAT.

DIGITAL SETTABLE STAIRCASE TIME SWITCH TLZ12D-plus THE ALLROUNDER

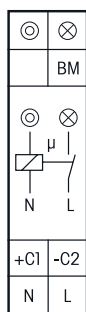

Typical connections

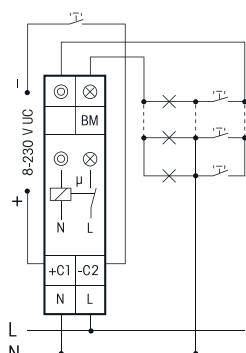

3-wire circuit, resettable.

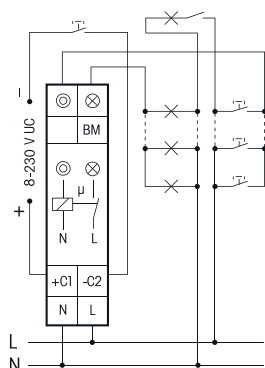

4-wire circuit with attic lighting, resettable.

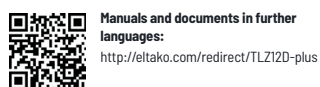

Manuals and documents in further languages:
<http://eltako.com/redirect/TLZ12D-plus>

Technical data page 15-10.
Housing for operating instructions
GBA14 page 1-49 chapter 1.

TLZ12D-plus



1 NO contact not potential free 16 A/250 V AC. 230 V LED lamps up to 600 W, energy saving lamps ESL up to 200 W, incandescent lamps up to 2300 W. Control voltage 230 V and/or 8..230 V UC. Switch-off early warning and permanent light by pushbutton switchable. Standby loss 0.5 watt only. With ESL optimisation and multifunction.

Modular device for DIN EN 60715 TH35 rail mounting. 1 module = 18 mm wide, 58 mm deep.

The functions and times are entered using the MODE and SET keys as described in the operating manual and indicated on the LC display. A keylock function is provided.

Zero passage switching to protect contacts and lamps.

The noiseless electronics do not even bother the sensitive ear – unlike many synchronous motors with mechanical gears.

By using a bistable relay coil power loss and heating is avoided even in the on mode.

The switched consumer may not be connected to the mains before the short automatic synchronisation after installation has terminated.

Control voltage, supply voltage and switching voltage 230 V. In addition electrically isolated universal voltage from 8 to 230 V UC. 3-wire and 4-wire circuits, resettable, with attic lighting if 4-wire circuit.

Automatic detection of the method of connection.

Glow lamp current up to 50 mA, dependent on the ignition voltage of the glow lamps.

Precise variable time range from 1 to 99 minutes.

Separate continuous light pushbutton with projecting SET button in the functions STS, ISO, IS and R.

With motion detector control input BM, which converts the input signal into a control impulse if the function STS is set. In this case the permanent light by pushbutton function is not active.

If the function STS is set, the lighting is switched on again after a power failure provided the set time has not yet elapsed.

The elapsed period is shown in the middle of the display. The set time flashes at the bottom edge of the display until the set period elapses. **The accrued switch-on time** is displayed there outside the elapsed time, first in hours (h), then in months (m) with 1 digit after the decimal point.

When the set time flashes but the elapsed time does not change, a control pushbutton is inhibited.

If switch-off early warning function is switched on, the light starts flickering in time variable from 10 to 50 seconds before time-out and is repeated three times at decreasing time intervals.

If permanent light by pushbutton is switched on, permanent light can be switched on by pressing the pushbutton longer than 1 second. This is switched off automatically after time variable from 0.5 to 10 hours or by pressing the pushbutton longer than 2 seconds. This function is not active at the BM input.

If both switch-off early warning function and permanent light by pushbutton are switched on, the switch-off early warning function is activated before the permanent light switches off.

If energy saving lamps are switched completely or partially, activate position 'ESL' in the menu guidance. This is indicated by a + sign next to the abbreviation for the function at the top of the display.

If the function STS is selected **the time can be extended** within the first second after switching on or resetting **by pressing the pushbutton repeatedly up to three times** (incrementing). Each momentary-contact control increments the set time once. This function is not active at the BM input.

With multifunction: Switchable to the functions **IS** (impulse switch), **R** (relay), **ISO** (impulse switch with off-delay) and **HC** (hour counter). After setting the required function, the function can be blocked. An arrow on the right of the abbreviation indicates the blocking status.

ISO: The impulse switch automatically disconnects after the set delay from 0.1 to 9.9 hours is timed out, provided there is no manual OFF command. Switch-off early warning, permanent light by pushbutton and ESL are also switchable if the function ISO is set.

HC: As long as the pushbutton input is excited, the + sign is indicated next to the abbreviation for the function HC at the top of the display. The time is added and indicated at the bottom of the display. Initially up to 9999 hours (h), then automatic change-over to months (m) each with 730 hours and display with 1 digit after the decimal point. The relay is not switched on if the function HC is set.

Menu guidance with selectable languages German, English or French as described in the attached operating instructions.

TLZ12D-plus	Digital settable staircase time switch, 1 NO contact 16 A	Art. No. 23100800	62,30 €/pc.
--------------------	---	--------------------------	--------------------

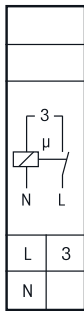

TLZ12-9



1 NO contact not potential free 16 A/250 V AC. 230 V LED lamps up to 600 W, energy saving lamps ESL up to 200 W, incandescent lamps up to 2300 W. Switch-off early warning switchable. Standby loss 0.7 watt only.

Modular device for DIN EN 50022 rail mounting. 1 module = 18 mm wide, 58 mm deep.

Zero passage switching to protect contacts and lamps.

The noiseless electronics do not even bother the sensitive ear - unlike many synchronous motors with mechanical gears.

By using a bistable relay coil power loss and heating is avoided even in the onmode.

The switched consumer may not be connected to the mains before the short automatic synchronisation after installation has terminated.

230 V control voltage, supply voltage and switching voltage.

Glow lamp current up to 50 mA, dependent on the ignition voltage of the glow lamps.

Precise variable time range from 1 to 12 minutes, settable by minute scale.

Own permanent light switch with the big rotary switch.

3-wire circuit with attic lighting, not resettable. Only for retrofitting of existing systems.

After a power failure the lighting is switched on again in case the set time has not elapsed yet.

If switch-off early warning function is switched on the light starts flickering approx. 30 seconds before time-out and is repeated three times at decreasing time intervals.

Function rotary switches

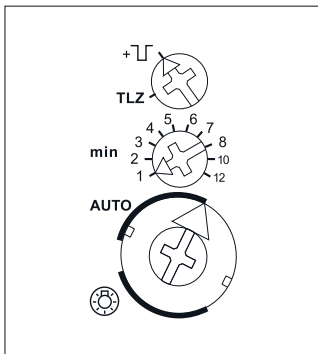

Standard setting ex works.

Typical connection

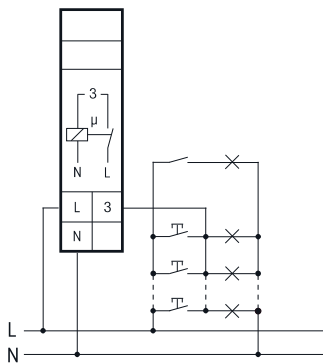

3-wire circuit with attic lighting, not resettable.

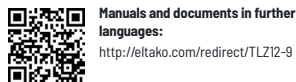

Manuals and documents in further languages:
<http://eltako.com/redirect/TLZ12-9>

Technical data page 15-10.
 Housing for operating instructions
 GBA14 page 1-49 chapter 1.

TLZ12-9	Staircase time switch, 1 NO contact 16 A	Art. No. 23100836	57,70 €/pc.
---------	--	-------------------	-------------

STAIRCASE TIME SWITCH TLZ61NP-230V

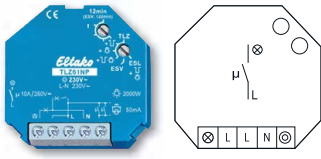

TLZ61NP-230V



1 NO contact not potential free 10 A/250 V AC. 230 V LED lamps up to 600 W, energy saving lamps ESL up to 200 W, incandescent lamps up to 2000 W. Switch-off early warning and permanent light by push-button switchable. Standby loss 0.7 watt only. With ESL optimisation.

Function rotary switches

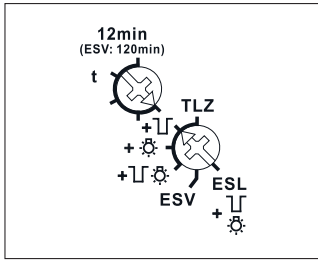

Standard setting ex works.

Typical connections

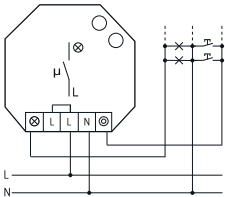

3-wire circuit, resettable.

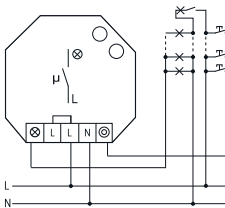

4-wire circuit with attic lighting, resettable.

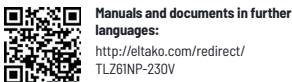

Technical data page 15-10.

Built-in device for installation. 45 mm long, 45 mm wide, 18 mm deep.

Zero passage switching to protect contacts and lamps.

By using a bistable relay coil power loss and heating is avoided even in the on mode.

The switched consumer may not be connected to the mains before the short automatic synchronisation after installation has terminated.

Control voltage, supply voltage and switching voltage 230 V. With infinitely variable time range from 1 to 12 minutes.

50 mA glow lamp current, dependent on the ignition voltage of the glow lamps.

3-wire and 4-wire circuits, resettable, with attic lighting if 4-wire circuit.

Automatic detection of the method of connection.

After a power failure the lighting is switched on again in case the set time has not elapsed yet.

If switch-off early warning function **is switched on**, the light starts flickering approx. 30 seconds before time-out and is repeated three times at decreasing time intervals.

If permanent light by pushbutton **is switched on**, permanent light can be switched on by pressing the pushbutton longer than 1 second. This is switched off automatically after 60 minutes or by pressing the pushbutton longer than 2 seconds.

If both switch-off early warning function and permanent light by pushbutton are switched on, the switch-off early warning function is activated before the permanent light switches off.

When energy saving lamps ESL are completely or partially switched, then set the switch-off early warning with the pushbutton permanent light ESL on the lower rotary switch.

If the function TLZ is selected the **time** can be **extended** within the first second after switching on or resetting by pressing the pushbutton repeatedly up to three times (incrementing).

Each momentary-contact control increments the set time once.

The function **ESV**, impulse switch with release delay up to 120 minutes, can be selected optionally. If this function is set it is automatically disconnected after the set delay is timed out if a manual OFF command has not been given.

If the timing period is set to minimum in the function **ESV**, the release delay is switched off.

The standard impulse switch function **ES** is then set.

= Switch-off early warning function

= Permanent light by pushbutton

= Switch-off early warning function and permanent light by pushbutton

TLZ61NP-230V	Staircase time switch, 1 NO contact 10 A	Art. No. 61100102	56,20 €/pc.
---------------------	--	--------------------------	--------------------

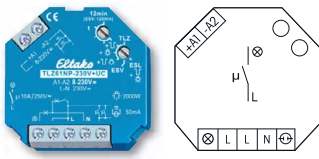

TLZ61NP-230V+UC



1 NO contact not potential free 10 A/250 V AC. 230 V LED lamps up to 600 W, energy saving lamps ESL up to 200 W, incandescent lamps up to 2000 W. Switch-off early warning and permanent light by push-button switchable. Standby loss 0.7 watt only. With ESL optimisation.

Function rotary switches

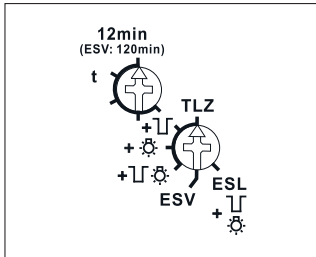

Standard setting ex works.

Typical connections

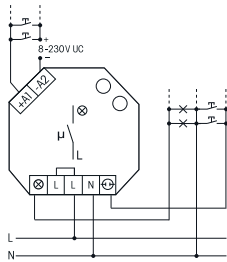

3-wire circuit, resettable

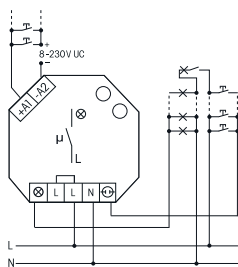

4-wire circuit with attic lighting, resettable

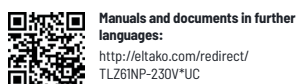

Technical data page 15-10.

Built-in device for installation. 45 mm long, 45 mm wide, 18 mm deep.

Zero passage switching to protect contacts and lamps.

By using a bistable relay coil power loss and heating is avoided even in the on mode.

The switched consumer may not be connected to the mains before the short automatic synchronisation after installation has terminated.

Control voltage, supply voltage and switching voltage 230 V. In addition electrically isolated universal voltage from 8 to 230 V UC.

With infinitely variable time range from 1 to 12 minutes. 50 mA glow lamp current, dependent on the ignition voltage of the glow lamps.

3-wire and 4-wire circuits, resettable, with attic lighting if 4-wire circuit.

Automatic detection of the method of connection.

After a power failure the lighting is switched on again in case the set time has not elapsed yet.

If switch-off early warning function **is switched on**, the light starts flickering approx. 30 seconds before time-out and is repeated three times at decreasing time intervals.

If permanent light by pushbutton **is switched on**, permanent light can be switched on by pressing the pushbutton longer than 1 second. This is switched off automatically after 60 minutes or by pressing the pushbutton longer than 2 seconds.

If both switch-off early warning function and permanent light by pushbutton are switched on, the switch-off early warning function is activated before the permanent light switches off.

When energy saving lamps ESL are completely or partially switched, then set the switch-off early warning with the pushbutton permanent light ESL on the lower rotary switch.

If the function TLZ is selected the **time** can be **extended** within the first second after switching on or resetting by pressing the pushbutton repeatedly up to three times (incrementing).

Each momentary-contact control increments the set time once.

The function **ESV**, impulse switch with release delay up to 120 minutes, can be selected optionally. If this function is set it is automatically disconnected after the set delay is timed out if a manual OFF command has not been given.

If the timing period is set to minimum in the function **ESV**, the release delay is switched off.

The standard impulse switch function **ES** is then set.

= Switch-off early warning function

= Permanent light by pushbutton

= Switch-off early warning function and permanent light by pushbutton

TLZ61NP-230V+UC	Staircase time switch, 1 NO contact 10A	Art. No. 61100301	60,40 €/pc.
------------------------	---	--------------------------	--------------------

TECHNICAL DATA STAIRCASE TIME SWITCHES

Type	TLZ12-8plus ^{b)} TLZ12D-plus ^{b)} TLZ12-9 ^{b)}	TLZ12G	TLZ12-8	TLZ61NP ^{b)} TLZ61NP+UC ^{b)}
Contacts				
Contact material/contact gap	AgSnO ₂ /0.5 mm	Opto-Triac	AgSnO ₂ /0.5 mm	AgSnO ₂ /0.5 mm
Spacing of control connections/contact Spacing of control connections C1-C2 or A1-A2/contact	3 mm 6 mm	3 mm 6 mm	3 mm -	3 mm 6 mm
Test voltage control connection/contact Test voltage C1-C2 or A1-A2/contact	2000 V 4000 V	- 4000 V	2000 V -	2000 V 4000 V
Rated switching capacity	16 A/250 V AC	up to 400 W	16 A/250 V AC	10 A/250 V AC
230 V LED lamps	up to 600 W ²⁾ I on ≤ 120 A/5 ms	up to 400 W ²⁾ I on ≤ 120 A/20 ms	up to 100 W ²⁾ I on ≤ 30 A/20 ms	up to 600 W ²⁾ I on ≤ 120 A/5 ms
Incandescent lamp and halogen lamp load ¹⁾ 230 V, I on ≤ 70 A/10 ms	2300 W	up to 400 W	2000 W TLZ12-9: 2300 W	2000 W
Fluorescent lamp load with KVG* in lead-lag circuit or non compensated	1000 VA	-	500 VA TLZ12-9: 1000 VA	1000 VA
Fluorescent lamp load with KVG* shunt-compensated or with EVG*	500 VA	up to 400 VA	500 VA	500 VA
Compact fluorescent lamps with EVG* and energy saving lamps ESL	up to 200 W ²⁾	up to 400 W ²⁾	up to 100 W ²⁾	up to 200 W ²⁾
Life at rated load, cos φ = 1 or for incandescent lamps 1000 W at 100/h	> 10 ⁵	∞	> 10 ⁵	> 10 ⁵
Life at rated load, cos φ = 0.6 at 100/h	> 4x10 ⁴	∞	> 4x10 ⁴	> 4x10 ⁴
Max. operating cycles	10 ³ /h	10 ³ /h	10 ³ /h	10 ³ /h
Maximum conductor cross-section (3-fold terminal)	6 mm ² (4 mm ²)	6 mm ² (4 mm ²)	6 mm ² (4 mm ²)	4 mm ²
Two conductors of same cross-section (3-fold terminal)	2.5 mm ² (1.5 mm ²)	2.5 mm ² (1.5 mm ²)	2.5 mm ² (1.5 mm ²)	1.5 mm ²
Screw head	slotted/crosshead, pozidriv	slotted/crosshead, pozidriv	slotted/crosshead, pozidriv	slotted/crosshead
Type of enclosure/terminals	IP50/IP20	IP50/IP20	IP50/IP20	IP30/IP20
Electronics				
Time on	100%	100%	100%	100%
Max./min. temperature at mounting location	+50°C/-20°C	+50°C/-20°C	+50°C/-20°C	+50°C/-20°C
Standby loss (activ power)	0.7 W; TLZ12D-plus: 0.5 W	0.4 W	0.7 W	0.7 W
Control current local at 230 V (<10 s) ± 20%	5(100)mA	5(100)mA	5(100)mA	5(100)mA
Control current universal control voltage 8/12/24/230 V (<10 s) ± 20%	2/4/9/5(100)mA	2/4/9/5(100)mA	-	2/4/9/5(100)mA (nur TLZ61NP+UC)
Max. parallel capacitance (approx. length) of individual control lead at 230 V AC	0.06 µF (200 m) C1/C2: 0.9 µF (3000 m)	0.9 µF (3000 m)	0.06 µF (200 m)	0.06 µF (200 m) A1-A2: 0.3 µF (1000 m)

* EVG = electronic ballast units; KVG = conventional ballast units

^{b)} Bistable relay as relay contact. The switched consumer may not be connected to the mains before the short automatic synchronisation after installation has terminated.

¹⁾ Applies for lamps with max. 150 W.

²⁾ Usually applies for dimmable 230 V LED lamps and dimmable energy saving lamps. Due to different lamp electronics and depending on the manufacturer, the maximum number of lamps may be limited, especially if the wattage of the individual lamps is very low (e.g. with 2 W LEDs).

To comply with DIN VDE 0100-443 and DIN VDE 0100-534, a Type 2 or Type 3 surge protection device (SPD) must be installed.

THE FRESH AIR PROFESSIONALS

Fresh air in the bathroom with the professional off-delay timers NLZ, also known as off-delay relay. Accurate timing is self-evident for this electronic device as well as noiseless operation. The off-delay timers with universal voltage offer additional appli-

cations as here even different potentials for switch and fan can be applied. The NP types have a settable operate delay up to 12 minutes.

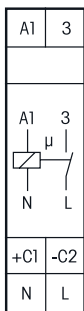

NLZ12NP-230V+UC



1 NO contact not potential free 16 A/250 V AC. Standby loss 0.5 watt only.

Modular device for DIN EN 60715 TH35 rail mounting.
1 module = 18 mm wide, 58 mm deep.

Zero passage switching to protect contacts and consumers.

State-of-the-art hybrid technology combines advantages of nonwearing electronic control with high capacity of special relays.

Control, supply and switching voltage 230 V. Additionally 8 to 230 V UC electrically isolated universal control voltage.

Very low switching noise.

Off-delay time settable from 1 to 12 min with the top rotary switch. Operating delay settable from 0 to 12 minutes with the middle rotary switch. Permanent ON and permanent OFF with the bottom rotary switch.

Function: When the control contact (light switch) is closed the operate delay AV starts (if not set '0 minutes'), on time-out the fan is switched on. The set release delay RV (delay time) starts when the control contact opens and if a set operating delay has elapsed.

The fan switches off on time-out.

This off-delay timer can be controlled by all dimmer switches EUD12 and EUD61 even in the minimum dimming position.

Function rotary switches

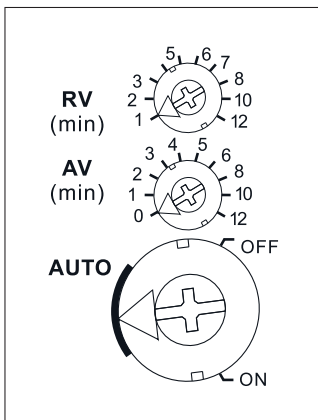

Standard setting examples.

RV = release delay (delay time)

AV = operating delay



Manuals and documents in further languages:
http://eltako.com/redirect/NLZ12NP-230V*UC

Technical data page 15-13.
Housing for operating instructions
GBA14 page 1-49 chapter 1.

Typical connections

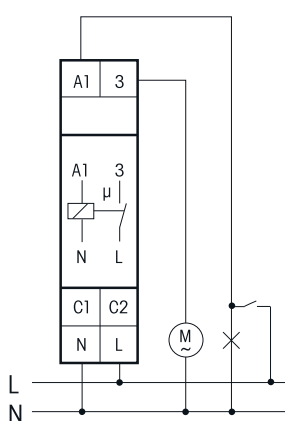

Fan control through light switch

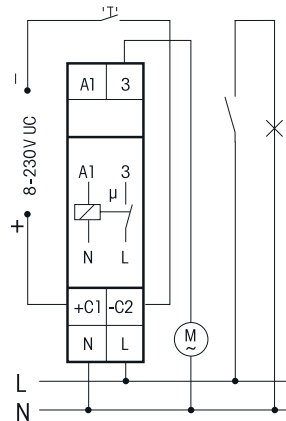

Fan control through ultra low voltage door contact, light is controlled separately

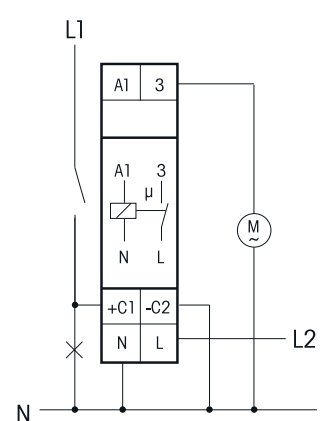

Fan control through light switch in case of different potentials on switch and fan

NLZ12NP-230V+UC	Off-delay timer, 1 NO contact 16 A	Art. No. 23100704	59,60 €/pc.
------------------------	------------------------------------	--------------------------	--------------------

OFF-DELAY TIMER NLZ61NP-UC

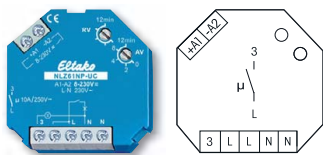

Function rotary switches

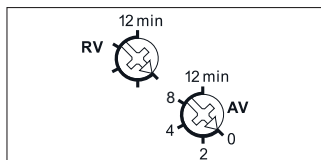

Standard setting ex works.



Manuals and documents in further languages:
<http://eltako.com/redirect/NLZ61NP-UC>

NLZ61NP-UC



1 NO contact not potential free 10 A/250 V AC. Standby loss 0.7 watt only.

Built-in device for installation. 45 mm long, 45 mm wide, 18 mm deep.

Zero passage switching to protect contacts and consumers.

State-of-the-art hybrid technology combines advantages of nonwearing electronic control with high capacity of special relays.

8 to 230 V UC universal control voltage, electrically isolated from the 230 V supply voltage and switching voltage.

By using a bistable relay coil power loss and heating is avoided even in the on mode.

The switched consumer may not be connected to the mains before the short automatic synchronisation after installation has terminated. The top rotary switch varies the off-delay time from 1 to 12 minutes.

Operating delay settable from 0 to 12 minutes with the lower rotary switch.

Function: When the control contact (light switch) is closed the operating delay AV starts (if not set '0 minutes'), on time-out the fan is switched on. The set release delay RV (delay time) starts when the control contact opens and if a set operating delay has elapsed. The fan switches off on time-out.

This off-delay timer can be controlled by all dimmer switches EUD12 and EUD61 even in the minimum dimming position.

Typical connections

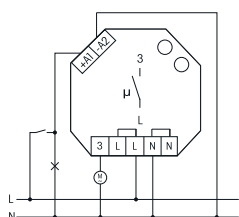

Fan control through light switch

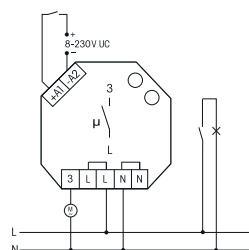

Fan control through ultra low voltage door contact, light is controlled separately

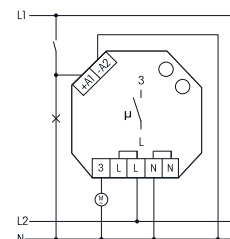

Fan control through light switch in case of different potentials on switch and fan

Technical data page 15-13.

NLZ61NP-UC	Off-delay timer, 1 NO contact 10A	Art. No. 61100704	56,80 €/pc.
-------------------	-----------------------------------	--------------------------	--------------------

Type	NLZ12NP	NLZ61NP-UC ^{b)}
Contacts		
Contact material/contact gap	AgSnO ₂ /0.5 mm	AgSnO ₂ /0.5 mm
Spacing of control connections/contact Spacing of control connections C1-C2 or A1-A2/contact	3 mm 6 mm	3 mm 6 mm
Test voltage control connection/contact Test voltage C1-C2 or A1-A2/contact	2000 V 4000 V	2000 V 4000 V
Rated switching capacity	16 A/250 V AC	10 A/250 V AC
Inductive load cos φ = 0,6/230 V AC Inrush current ≤ 35 A	650 W	650 W
Life at rated load, cos φ = 0.6	> 4x10 ⁴	> 4x10 ⁴
Max. operating cycles	10 ³ /h	10 ³ /h
Maximum conductor cross-section (3-fold terminal)	6 mm ² (4 mm ²)	4 mm ²
Two conductors of same cross-section (3-fold terminal)	2.5 mm ² (1.5 mm ²)	1.5 mm ²
Screw head	slotted/crosshead, pozidriv	slotted/crosshead
Type of enclosure/terminals	IP50/IP20	IP30/IP20
Electronics		
Time on	100%	100%
Max./min. temperature at mounting location	+50°C/-20°C	+50°C/-20°C
Standby loss (activ power)	0.5 W	0.7 W
Control current local at 230 V (<10 s) ± 20%	2 mA	1 mA
Control current universal control voltage 8/12/24/230 V (<10 s) ± 20%	2/4/9/5(100) mA	2/4/9/5(100) mA
Max. parallel capacitance (approx. length) of individual control lead at 230 V AC	0,06 μF (200 m) C1/C2: 0.9 μF (3000 m)	0.06 μF (200 m) A1-A2: 0.3 μF (1000 m)

* EVG = electronic ballast units; KVG = conventional ballast units

^{b)} Bistable relay as relay contact. The switched consumer may not be connected to the mains before the short automatic synchronisation after installation has terminated.

To comply with DIN VDE 0100-443 and DIN VDE 0100-534, a Type 2 or Type 3 surge protection device (SPD) must be installed.

EGS12Z-UC
EGS61Z
MSR12-UC
MS

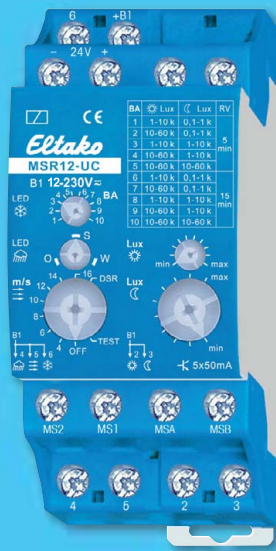

**CABLE-BOUND SHADING SYSTEMS AND
ROLLER SHUTTER CONTROL - THE MODULAR
APPROACH FOR THE ELECTRICAL TRADE.**

Cable-bound shading systems and roller shutter control

Shading systems and roller shutter control	16 - 2
Multi sensor MS, rain sensor RS, light sensor LS and wind sensor WS	16 - 3
Multifunction sensor relay MSR12-UC	16 - 4
Digital settable sensor relay LRW12D-UC	16 - 5
Impulse group switch EGS12Z-UC for central control	16 - 6
Impulse group switch EGS12Z2-UC for central control	16 - 7
Motor isolating relay MTR12-UC and DC motor relay DCM12-UC	16 - 7
Impulse group switch EGS61Z-230V for central control	16 - 8
Motor isolating relay MTR62-230V	16 - 9
Technical data shading systems and roller shutter control	16 - 10
Typical circuit example of a shading system control	16 - 11
Typical circuit example of a roller shutter control and shading system control	16 - 12
Typical circuit examples of a roller shutter control	16 - 13

THE MODULAR APPROACH FOR THE ELECTRICAL TRADE

Planning and realisation of a shading system or roller shutter control are classical tasks for the electrical installer.

Eltako has developed a well thought-out modular system of control devices and switchgear for mounting in switch cabinets and distribution boards.

The modular approach has been chosen to provide a control or switch-gear device (module) for any desired function match the overall system, typically permitting an individual awning to be controlled as perfectly as a large system which comprises dozens of shutters, awnings, Venetian blinds, etc.

Any assignment of control devices to the switchgear devices can be chosen, and provision is made for easy modifications, retrofitting and expansion, "bit by bit".

There are four groups of devices:

1. Sensors

Sensors serve to detect the actual situation. A light sensor, for example, measures brightness and generates a control voltage as a function of it.

2. Sensor relays

Sensor relays serve to convert the sensor-produced actual signals to control signals as a function of practical set points, whilst logic operations are performed and faulty sensors detected.

3. Actuators

Actuators serve to control the motors of shading systems and roller shutters. These are group impulse switches in hybrid technology with central control functions and possibly motor isolating relays or DC motor relays.

4. Accessories

Switching power supply units for the power supply of the multi sensor and the multifunction sensor relay as well as for the heating of the rain sensors are available as accessories.

Sensors, page 16-3	Sensor relays, page 16-4 and 16-5	Actuators, page 16-6 to 16-9
Multi sensor MS	Multifunction sensor relay MSR12-UC for brightness, twilight, wind, rain and frost	Group impulse switch EGS12Z-UC
Rain sensor RS	Light-twilight-rain-wind sensor relay LRW12D for light, twilight and wind	Group impulse switch EGS12Z2-UC
Light sensor LS		Group impulse switch EGS61Z
Wind sensor WS		Motor isolating relay MTR12-UC and MTR62
		DC motor relay DCM12-UC

The principle of overall control is quite simple: each shading element or its motor is controlled by an actuator that receives commands via sensors and, where fitted, sensor relays.

A complete Control System consists (as the smallest unit) of a switch or momentary contact switch controlled EGS12Z-UC group impulse switch for one motor. The largest unit comprises any number of sensors and sensor relays as well as any number of impulse group switches EGS12Z-UC and EGS12Z2-UC with or without motor isolating relay MTR12 and DC motor relay DCM12-UC to control the motors.

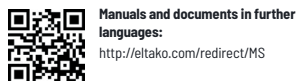

Manuals and documents in further languages:
<http://eltako.com/redirect/MS>

MS

Multi sensor

The MS multi sensor sends the current weather details, including brightness (from three points of the compass), wind, rain and frost, to the multifunction sensor relay MSR12-UC connected in series once per second. A standard telephone wire is sufficient as connecting lead: J-Y(ST)Y 2x2x0.8 or equivalent. 100 m line length is permitted. Solid plastic housing, l x w x h = 118 x 96 x 77 mm. Protection degree IP44. Temperature at mounting location -30°C to +50°C. A power supply unit WNT15-24VDC/24W (chapter 17) is required for the power supply, including heating of the rain sensor. This is only 1 module = 18 mm wide and it also it supplies the multifunction sensor relay MSR12-UC (page 16-4). Several MSR12-UC can be connected to a multisensor MS, e.g. for evaluating up to three directions with the light sensor of the MS.

MS	Multi sensor	Art. No. 20000084	309,20 €/pc.
----	--------------	-------------------	--------------

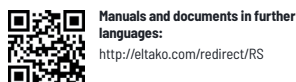

Manuals and documents in further languages:
<http://eltako.com/redirect/RS>

RS

Rain sensor

The rain sensor RS reports rain to the sensor relay LRW12D connected in series once per second. A standard telephone wire is sufficient as connecting lead: J-Y(ST)Y 2x2x0.8 or equivalent. 100 m line length is permitted. Solid plastic housing, l x w x h = 118 x 96 x 77 mm. Protection degree IP44. Temperature at mounting location -30°C to +50°C. A power supply unit WNT61-24VDC/10W or WNT15-24VDC/24W (chapter 17) is required for the power supply, including heating of the rain sensor (1.2 W). An LED lights up green when the supply voltage is applied and lights up yellow for rain.

RS	Rain sensor	Art. No. 20000087	142,70 €/pc.
----	-------------	-------------------	--------------

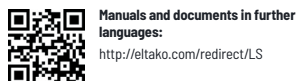

Manuals and documents in further languages:
<http://eltako.com/redirect/LS>

LS

Light sensor

The LS light sensor generates a voltage dependent on light intensity by means of a photo resistor. This voltage is evaluated in a LRW12D universal sensor relay connected in series. Solid plastic housing, l x w x h = 38 x 28 x 95 mm, Protection degree IP54. Temperature at mounting location -20°C to +60°C. Mounting with the supplied screw and nut on the accompanying aluminum mounting bracket or directly on the plastic mounting bracket KM1 of the wind sensor WS. Maximum diameter of the measuring cable (not included in the scope of supply) 5 mm.

LS	Light sensor	Art. No. 20000080	34,20 €/pc.
----	--------------	-------------------	-------------

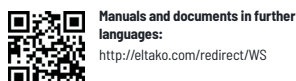

Manuals and documents in further languages:
<http://eltako.com/redirect/WS>

WS

Wind sensor

The WS wind sensor provides a sequence of pulses as a function of the wind vane speed. This pulse sequence is evaluated in a LRW12D universal sensor relay connected in series. Solid plastic housing, 125 mm dia. x 117 mm high. Protection degree IP54. Temperature at mounting location -15°C to +60°C. For mounting, use KM1 plastic mounting bracket that comes with the device. With 5-metre measuring lead connected.

WS	Wind sensor	Art. No. 20000082	79,70 €/pc.
----	-------------	-------------------	-------------

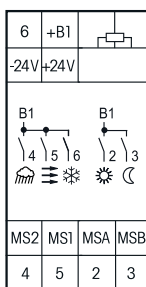

MSR12-UC



Multifunction sensor relay for brightness, twilight, wind, rain and frost, 5 OptoMOS semiconductor outputs 50 mA/12..230 V UC. Standby loss without Multi sensor MS 0.5 watt only.

Modular device for DIN 60715 TH35 rail mounting. 2 modules = 36 mm wide, 58 mm deep. The multi-sensor relay MSR12-UC evaluates the signals from the multisensor MS once per second, and sends appropriate control signals to the downstream EGS12Z-UC or EGS12Z2-UC actuators depending on the setting of the rotary switch on the front.

The OptoMOS semiconductor outputs switch the voltage applied to the universal voltage input terminal +B1. Only a single Multisensor MS can be connected to a Multifunction sensor relay MSR12-UC. Several MSR12-UC can be connected to a multisensor MS, e.g. for evaluating up to three directions with the light sensor of the MS. Only a single MSR12-UC must provide the outer terminal resistance. It must be removed if there is a further MSR12-UC. Supply voltage 24 V DC from power unit WNT15-24VDC/24W (chapter 17). This power unit simultaneously supplies the multisensor MS connected to the terminals MS1, MS2, MSA and MSB, including heating of the rain sensor surface. After installation wait for the short automatic synchronisation of approx. 1 minute. During this process three LEDs flash in a slow sequence.

Function rotary switches

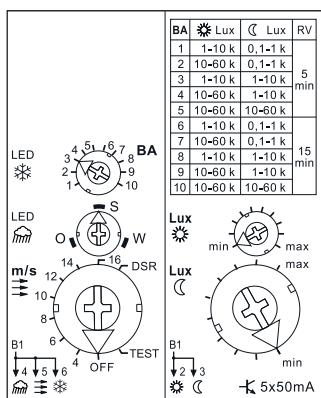

Standard setting ex works.

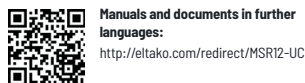

Function rotary switches

BA = Setting the operating modes 1 to 10 from the adjacent table. 2 delay times RV - for wind and twilight - each in connection with 5 brightness ranges for light and twilight. The LED behind the rotary switch indicates Frost when the outdoor temperature drops below 2°C, at which point output 6 closes. This output opens again as soon as the temperature is over 3°C for 5 minutes.

O-S-W = If the Multisensor MS is aligned towards the south, the weighting for light and twilight can be shifted towards the east or west. If the MS is mounted in a different direction, the desired point of the compass can be set using this rotary switch. An LED behind the rotary switch indicates **rain detection**, at which point output 4 closes. Once the rain sensor surface dries out - assisted by a heating unit - contact 4 opens immediately. This is automatically followed by a 2-second pulse on output 2 if the sun signal is applied at that moment.

m/s = This rotary switch is used to select the wind speed in metres per second at which the **wind signal** is triggered. This closes output 5. This is indicated by the LED behind the rotary switch. Opening takes place after the set delay time RV, during which the LED flashes. This is automatically followed by a 2-second pulse on output 2 if the sun signal is applied at that moment.

DSR = In this position of the wind rotary switch the MSR12-UC functions like a twilight sensor relay. The twilight signal as described under **Lux ☾** is then continuously applied to output 3 as long as the set twilight value is undershot. Output 3 opens with a delay of 5 minutes if the brightness value set is overshoot. The outputs 4 (rain) and 6 (frost) remain active as described there. Output 5 (wind) likewise remain active, but the wind signal is triggered at 10 m/s.

TEST = As long as TEST remains switched on, each switchover from the OFF position to the TEST position activates the outputs 2 to 6 in ascending order.

OFF = In the OFF position the MSR12-UC has no function.

Lux ☾ = This rotary switch is used to set the brightness at which the sun signal is immediately triggered as a 2-second pulse at output 2. The LED behind the rotary switch indicates when the brightness value is exceeded.

Lux ☼ = This rotary switch is used to set the brightness at which the 2-second twilight signal is triggered at output 3 after the set delay time RV when the value is undershot. This is indicated by the LED behind the rotary switch. It flashes during the delay time. If the twilight switching threshold is set to the same level or higher than the sun switching threshold, then the sun switching threshold is raised internally above the twilight switching threshold.

Changing light compensation: Constant changes between sun and rain clouds would result in sensitive closing and opening of the shade elements. This is prevented by a changing light compensation function.

Sensor function and open circuit monitoring: The Multisensor MS sends updated information to the MSR12-UC every second. If this signal is missing completely for 5 seconds, or if the individual signal from the wind sensor is missing for 24 hours, then an alarm is triggered: three LEDs flash rapidly and the wind output 5 is closed for 2 seconds in order to protect any awnings or windows which may be connected here. This pulse is repeated every hour. The alarm is turned off automatically when a signal is detected again.

Technical data page 16-10.
Typical connections page 16-11.
Housing for operating instructions
GBA14 page 1-49 chapter 1.

MSR12-UC	Multifunction sensor relay, 5 OptoMOS	Art. No. 22500501	100,20 €/pc.
-----------------	---------------------------------------	--------------------------	---------------------

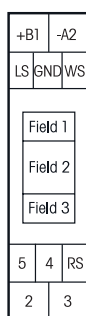

Manuals and documents in further languages:
<http://eltako.com/redirect/LRW12D-UC>

Technical data page 16-10.
 Typical connections page 16-12.
 Housing for operating instructions
 GBA14 page 1-49 chapter 1.

LRW12D-UC



**Light-twilight rain wind sensor relay, 4 OptoMOS semiconductor outputs 50 mA/12..230 V UC.
 Standby loss 0.05–0.5 watt only.**

Modular device for DIN 60715 TH35 rail mounting. 1 module = 18 mm wide, 58 mm deep.
 Supply voltage 12 to 230 V UC.

The sensor relay LRW12D evaluates the signals from the light sensor LS, the rain sensor RS and the wind sensor WS and sends appropriate control signals to the downstream EGS12Z-UC or EGS12Z-UC actuators depending on the setting via the display on the front panel.

The OptoMOS semiconductor outputs switch the voltage applied to the universal voltage input terminal +B1. A light sensor LS, rain sensor RS and wind sensor WS can be connected to a sensor relay LRW12D.

However, only one per sensor.

If one or two of the three possible sensors are not connected, OFF has to be selected in the function menu for the relevant sensor.

However, at a wind sensor WS several LRW12D can be connected for controlling different wind speeds. Then the LRW12D must be connected to the same potential +B1/-A2.

When the supply voltage is applied to B1/A2, the LRW12D can be set as described in the operating instructions.

LRW12D-UC	Digital settable sensor relay, 4 OptoMOS	Art. No. 22400501	81,40 €/pc.
------------------	--	--------------------------	--------------------

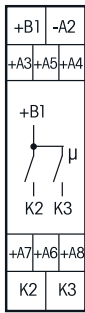

EGS12Z-UC



Impulse group switch for central control, 1+1 NO contacts not potential free 10 A/250 V AC, for 1 motor or motor relays. Standby loss 0.05-0.4 watt only.

Modular device for DIN 60715 TH35 rail mounting. 1 module = 18 mm wide, 58 mm deep. This impulse group switch serves to implement commands generated by the sensor relays or by switches and push-buttons and controls a motor, a motor isolating relay MTR12-UC or a DC motor relay DCM12-UC dependent on the setting of the rotary switch on the front. 12 to 230 V UC supply voltage and switching voltage at terminals +B1/-A2. The control voltage at terminals A3 up to A8 must have an identical potential.

The function of this electronic group impulse switch is based on the principle that, on the one hand, impulse control is used to obtain UP-Stop-DOWN-Stop (contact 1 closed - both contacts open - contact 2 closed - both contacts open) and, on the other hand, additional control inputs can be used to select UP or DOWN as desired. **Dynamic** refers to control inputs for which one impulse of not less than 20 milliseconds is sufficient to close a contact. **Static** denotes a control input for which the contact is only closed as long as the control command is applied. UP and DOWN apply to roller shutters, Venetian blinds and roller blinds. For awnings, 'UP' = retract and 'DOWN' = extend. For windows 'UP' = open and 'DOWN' = close.

Function rotary switches

AUTO 1 = When the lower rotary switch is in this position, the local advanced automatic reversing system for Venetian blinds is activated. When a push-button connected to A3+A4 (connected with a bridge) or A5/A6 connected to a dual push-button are used for local control a double impulse activates a slow rotation in the opposite direction, which can be stopped with a further impulse.

AUTO 2 = When the lower rotary switch is in this position, the local advanced automatic reversing system for Venetian blinds is completely switched off.

AUTO 3 = When the lower rotary switch is in this position, the local advanced automatic reversing system for Venetian blinds is switched off as well. The central control inputs A5 and A6 though, which are dynamic at AUTO 1 and AUTO 2, **are static at first, thus, allow reversal of Venetian blinds by operating pushbuttons.** They only switch to dynamic after 1 second continuous operation.

▲▼ = ▲ (UP) and ▼ (DOWN) of the lower rotary switch are the positions for **manual control**. Manual control has priority over all other control commands.

WA = Automatic reversal for Venetian blinds and awnings is controlled by means of the middle rotary switch. 0 = OFF, otherwise from 0.1 to 5 seconds ON with selected reversal time. In this case, it is only for DOWN that the direction is reversed on time-out of the time lag selected by means of the top rotary switch, e.g. to extend awnings or set Venetian blinds to a defined position.

RV = The time delay (delay time RV) is set by means of the top rotary switch. If, the group impulse switch is in the UP or DOWN position the selected delay time runs (elapses); at time-out the device changes automatically to STOP. Therefore, the time delay must be chosen at least as long as the shading element or roller shutter will need to move from one limit position to the other. The LED indication for the delay times WA and RV is located behind this rotary switch.

Local control with pushbutton connected to terminals A3+A4 (to be connected with a bridge). Each impulse causes the group impulse switch to change its position in the UP-Stop-DOWN-Stop sequence.

Local control with roller shutter toggle switch connected to terminals A3 and A4.

Local control with dual roller shutter pushbutton connected to A5 and A6. The 'UP' or 'DOWN' position is activated with an impulse by pushbutton. A further impulse from one of the two push-buttons stops the sequence immediately.

Central control dynamic without priority connected to terminals A5 (UP) and A6 (DOWN). Up or DOWN is activated by a control signal. A further control signal (<700ms) at this control input interrupts this process immediately, a further control signal (>700ms) continues the process. **This is without priority** because the local input A3+A4 (with bridge) and the central control inputs A7 and A8 can immediately override even whilst the control contact on A5 or A6 is still closed.

Central control dynamic with priority connected to terminals A7 (UP) and A8 (DOWN). **With priority** because these control inputs cannot be overridden by other control inputs **as long as** the central control contact is closed. Otherwise it has the same function as the central control dynamic without priority. These central control inputs A7 and A8 are used for the sensor relays MSR12 and LRW12D for the wind sensor, the frost sensor and the rain sensor functions as these are required to have absolute priority over other sensor commands.

Function rotary switches

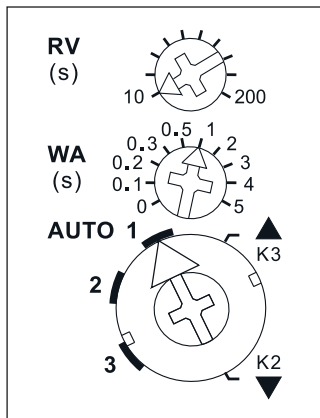

Standard setting ex works.



Manuals and documents in further languages:
<http://eltako.com/redirect/EGS12Z-UC>

Technical data page 16-10.
Housing for operating instructions
GBA14 page 1-49 chapter 1.

EGS12Z-UC	Impulse group switch, 1 + 1 NO contacts 10 A	Art. No. 21200401	78,40 €/pc.
-----------	--	-------------------	-------------

**IMPULSE GROUP SWITCH EGS12Z2-UC FOR CENTRAL CONTROL,
MOTOR ISOLATING RELAY MTR12-UC AND DC MOTOR RELAY DCM12-UC**

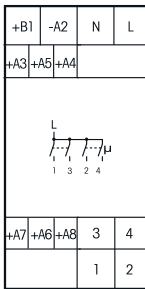

EGS12Z2-UC



Impulse group switch for central control, 2+2 NO contacts not potential free 5 A/250 V AC, for two 230 V-motors. Standby loss 0.05-0.9 watt only.

Modular device for DIN 60715 TH35 rail mounting. 2 modules = 36 mm wide, 58 mm deep.

Supply voltage 12..230 V UC at terminals +B1/-A2. The control voltage at terminals A3 up to A8 must have an identical potential. This impulse group switch serves to implement commands generated by the sensor relays or by switches and pushbuttons and controls two 230 V motors according to the setting of the rotary switches on the front. 1/2 = motor 1, 3/4 = motor 2.

The mode of operation corresponds completely to the impulse group switch EGS12Z-UC on page 16-6 in which a MTR12-UC as described below is integrated.

EGS12Z2-UC	Impulse group switch, 2 + 2 NO contacts 5 A	Art. No. 21400401	99,70 €/pc.
-------------------	---	--------------------------	--------------------



Manuals and documents in further languages:
<http://eltako.com/redirect/EGS12Z2-UC>

Technical data page 16-10.
Typical connections page 16-12.
Housing for operating instructions
GBA14 page 1-49 chapter 1.



MTR12-UC



Motor isolating relay, 2+2 NO contacts not potential free 5 A/250 V AC for one or two 230 V-motors. Standby loss 0.5 watt only.

Modular device for DIN 60715 TH35 rail mounting. 1 module = 18 mm wide, 58 mm deep.

Universal control voltage 8..230 V UC. 230 V supply voltage.

The tube-mounted motors of shading elements and roller shutters must not be connected in parallel, or reverse voltages will occur through the limit switches, ultimately causing failure of the motors.

For one motor and if the control voltage and the motor voltage are 230 V, one EGS12Z-UC is adequate.

Where more than one motor is controlled by an EGS12Z-UC or in case the control voltage is different, one MTR12-UC must be connected to two motors. It must be remembered that the MTR12-UC devices, while they can be operated in parallel, require unassigned contact outputs K2/K3 of the controlling EGS12Z-UC. These have to be connected to terminals K2/K3 of the MTR12-UC. 1/2 = motor 1, 3/4 = motor 2.

The functions UP and DOWN may be blocked or switched off entirely by a rotary switch. This block applies only to the max. 2 connected motors. Therefore single shading elements or roller shutters can be completely or partially excepted from the automatic function of an over-all control.

MTR12-UC	Motor isolating relay, 2 + 2 NO contacts 5 A	Art. No. 22400601	74,20 €/pc.
-----------------	--	--------------------------	--------------------

Function rotary switch

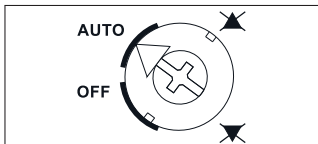

MTR12-UC und DCM12-UC



Manuals and documents in further languages:
<http://eltako.com/redirect/MTR12-UC>

Technical data page 16-10.
Housing for operating instructions
GBA14 page 1-49 chapter 1.

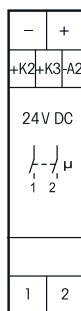

DCM12-UC



DC motor relay, 2 NO contacts not potential free 24 V DC/90 watt, for one 24 V DC motor. Standby loss 0.07 watt only.

Modular device for DIN 60715 TH35 rail mounting. 1 module = 18 mm wide, 58 mm deep.

Universal control voltage 8..230 V UC. 24 V DC supply voltage.

The DCM12-UC can be operated in parallel, but they require unassigned contact outputs K2/K3 of the controlling EGS12Z-UC. These have to be connected to terminals K2/ K3 of the DCM12-UC.

The functions UP and DOWN may be blocked or switched off entirely by a rotary switch. This block applies only to the 1 connected motor. Therefore single shading elements or roller shutters can be completely or partially excepted from the automatic function of an over-all control.

DCM12-UC	DC motor relay, 2 NO contacts 24 V DC/90 W	Art. No. 22400602	71,40 €/pc.
-----------------	--	--------------------------	--------------------



Manuals and documents in further languages:
<http://eltako.com/redirect/DCM12-UC>

Technical data page 16-10.
Housing for operating instructions
GBA14 page 1-49 chapter 1.

Recommended retail prices excluding VAT.

IMPULSE GROUP SWITCH EGS61Z-230V FOR CENTRAL CONTROL

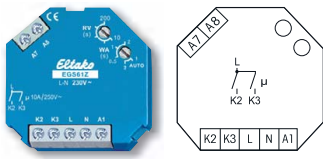

EGS61Z-230V



Impulse group switch for central control, 1+1 NO contacts not potential free 10 A/250 V AC, for one 230 V AC motor. Standby loss 0.4 watt only.

Function rotary switches

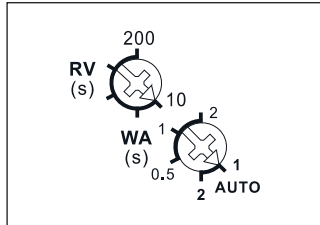

Standard setting ex factory.

Typical connection UT

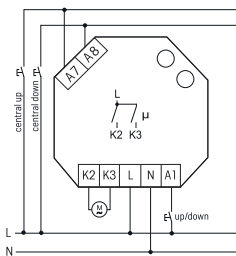

Typical connection RT

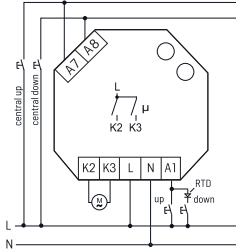

For installation. 45 mm long, 45 mm wide, **32 mm deep.**

State-of-the-art hybrid technology combines advantages of nonwearing electronic control with high capacity of special relays.

This impulse group switch serves to implement commands generated by the sensor relays or by switches and push-buttons and controls a 230 V motor for a shading element or a roller shutter.

Control, supply and switching voltage 230 V.

The same control voltage must be supplied to A1, A7 and A8 as to L.

By using bistable relays coil power loss and heating is avoided even in the on mode.

The switched consumer may not be connected to the mains before the short automatic synchronisation after installation has terminated.

A universal pushbutton connected to control input A1 controls the pulse signals for 'up, stop, down, stop'. A direction pushbutton for 'down' can be connected via the diode RTD (any polarity). Another direction pushbutton for 'up' is connected directly to A1. On the first control pulse 'down', EGS61Z switches over the control input A1 to 'direction pushbutton'. To switch the control input back to 'universal pushbutton', briefly switch off the power supply and switch back on. Additional control inputs A7 and A8 can be used for central control UP or DOWN with priority.

With priority because these control inputs cannot be overridden by other control inputs **as long as** the central control contact is closed. Up or DOWN is activated by a control signal. A further control signal (< 700 ms) at this control input interrupts this process immediately, a further control signal (> 700 ms) continues the process.

The time delay (delay time RV) is set by means of the rotary switch **RV**. If, the group impulse switch is in the UP or DOWN position the selected delay time runs (elapses); at time-out the device changes automatically to STOP. Therefore, the time delay must be chosen at least as long as the shading element or roller shutter will need to move from one limit position to the other.

With the rotary switch **WA** automatic reversal is controlled: in the setting from 0.5 to 2 sec. reversal time the automatic reversal is activated. In this case, it is only for DOWN that the direction is reversed on time-out of the time lag selected by means of the top rotary switch RV, e.g. to extend awnings or set Venetian blinds to a defined position.

AUTO 1: No automatic reversal and no local advanced automatic reversing system.

A7, A8 and direction pushbutton: Operation <1s → static process (contact closes only during operation)
Operation >1s → dynamic process (contact remains closed), stop command by new operation.

AUTO 2: Automatic reversal with 1s reversal time. Additionally the local advanced automatic reversing system for Venetian blinds with universal pushbutton at A1 is active: a double impulse activates a slow rotation in the opposite direction, which can be stopped with a further impulse.

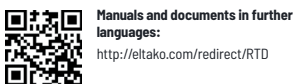
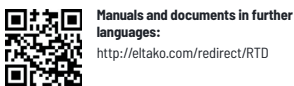

RTD	Direction pushbutton diode	Art. No. 60000015	4,20 €/pc.
EGS61Z-230V	Impulse group switch, 1+1 NO contacts 10 A	Art. No. 61200430	74,50 €/pc.



Technical data page 16-10.

Recommended retail prices excluding VAT.



Manuals and documents in further languages:
<http://eltako.com/redirect/MTR62-230V>

Technical data page 16-10.

MTR62-230V



**Motor isolating relay, 2+2 NO contacts not potential free 4 A/250 V AC, for two 230 V motors.
 No standby loss.**

For installation. 49x51mm, 22 mm deep.

The connection terminals are plug-in terminals for conductor cross-sections from 0.2 mm² to 2.5 mm².

The MTR is a control relay for controlling one or two blind and roller shutter motors with mechanical or electronic limit switches.

The tubular motors of the shading elements and roller shutters must never be connected directly in parallel, otherwise reverse voltages will occur via the limit switches and ultimately the motors will be destroyed. Several MTRs can be connected in parallel at the inputs.

For example, EGS12Z, EGS61Z, FSB14, FSB61NP and FJ62NP are suitable for activation.

Control and switching voltage 230 V.

Attention! The switching time between the up and down command must be ≥ 500 ms (observe the technical data of the motor).

MTR62-230V	Motor isolating relay, 2 + 2 NO contacts 4 A	Art. No. 61400603	58,70 €/pc.
-------------------	--	--------------------------	--------------------

TECHNICAL DATA SHADING SYSTEMS AND ROLLER SHUTTER CONTROL

Type	EGS12Z ^{b)}	EGS12Z2 ^{b)}	EGS61Z ^{b)}	LRW12D/MSR12 ¹⁾	MTR12/DCM12	MTR62
Contacts						
Contact material/contact gap	AgSnO ₂ /0.5 mm	AgSnO ₂ /0.5 mm	AgSnO ₂ /0.5 mm	OptoMOS	AgSnO ₂ /0.5 mm	AgSnO ₂ /0.5 mm
Spacing of control connections/contact	3 mm	3 mm	3 mm	3 mm/6 mm	3 mm	1 mm
Test voltage as per VDE 0110 control connection/contact	2000 V	2000 V	2000 V	LRW12D: 2000 V MSR12: 4000 V	2000 V	-
Rated switching capacity	10 A/250 V AC	5 A/250 V AC	10 A/250 V AC	50 mA/8...230 V UC	5 A/250 V AC DCM: 90 W	4 A/250 V AC
Inductive load cos φ = 0.6/230 V AC inrush current ≤ 35 A	650 W	650 W ²⁾	650 W	-	MTR12: 650 W ²⁾	650 W
Life at rated load, cos φ = 0.6	>4x10 ⁴	>4x10 ⁴	>4x10 ⁴	-	>4x10 ⁴	>4x10 ⁴
Switch position indication	WA and RV	WA and RV	-	LRW12D: Display MSR12: LED	LED	-
Maximum conductor cross-section (3-fold terminal)	6 mm ² (4 mm ²)	6 mm ² (4 mm ²)	4 mm ²	6 mm ² (4 mm ²)	6 mm ² (4 mm ²)	2.5 mm ²
Two conductors of same cross-section (3-fold terminal)	2.5 mm ² (1.5 mm ²)	2.5 mm ² (1.5 mm ²)	1.5 mm ²	2.5 mm ² (1.5 mm ²)	2.5 mm ² (1.5 mm ²)	-
Screw head	slotted /cross-head, pozidriv	slotted /cross-head, pozidriv	slotted /cross-head	slotted /cross-head, pozidriv	slotted /cross-head, pozidriv	-
Type of connection	-	-	-	-	-	plug-in terminals
Type of enclosure/terminals	IP50/IP20	IP50/IP20	IP30/IP20	IP50/IP20	IP50/IP20	IP50/IP20
Electronics						
Time on (also for central on/off)	100%	100%	100%	100%	100%	100%
Max./min. temperature at mounting location	+50°C/-20°C	+50°C/-20°C	+50°C/-20°C	+50°C/-20°C	+50°C/-20°C	+50°C/-20°C
Standby loss (active power) at 230 V	0.4 W	0.9 W	0.4 W	LRW12D: 0.5 W MSR12: -	MTR12: 0.5 W	-
Standby loss (active power) at 24 V	0.1 W	0.1 W	-	LRW12D: 0.1 W MSR12: 0.5 W	DCM12: 0.07 W	-
Standby loss (active power) at 12 V	0.05 W	0.05 W	-	LRW12D: 0.05 W MSR12: -	-	-
Control current A1 or A3-A8 at 12/24/230 V ±20%	0.05/0.11/0.7 mA	0.05/0.11/0.7 mA	-/-/0.7 mA	-	0.1/0.2/1 mA	4 mA
Max. parallel capacitance (approx. length) of control lead at 230 V AC	0.06 μF (200 m)	0.06 μF (200 m)	0.3 μF (1000 m)	-	0.3 μF (1000 m)	10 nF (30 m)
Min. command duration	50 ms	50 ms	50 ms	-	-	50 ms

^{b)} Bistable relay as relay contact. Do not connect the switched consumer to the mains before the short automatic synchronisation after installation has terminated.

¹⁾ After installation and after a power failure the multisensor needs approx. 1 minute before the wind sensor is active. During this process the outputs wind and sun of the MSR12-UC are blocked and 3 LEDs flash slowly.

²⁾ Inductive load cos φ = 0.6 as sum of both contacts 1000 W max.

16-10

If necessary, see the operating instructions of the appropriate shading elements for the maximum wind speed that can be set for the sensor relays.

m/s	4	6	8	10	12	14	16
km/h	14.4	21.6	28.8	36.0	43.2	50.4	57.6
Bft	3	4	4	5	6	7	7

Do not route measurement leads parallel to other electrical lines - measurement leads must be screened statically if longer than 10m. For example JY-ST-Y. To extend leads use screw terminals and damp-proof connectors.

When selecting an installation site for light, wind and multi sensors, ensure that the sensors are not in the shadow of the objects being monitored.

To comply with DIN VDE 0100-443 and DIN VDE 0100-534, a Type 2 or Type 3 surge protection device (SPD) must be installed.

TYPICAL CIRCUIT EXAMPLE OF A SHADING SYSTEM CONTROL

WITH MULTIFUNCTION SENSOR RELAY MSR12-UC

For clarity, the L and N connections are not shown.
 Similarly, provision made for local control through A3 and A4 are not shown.

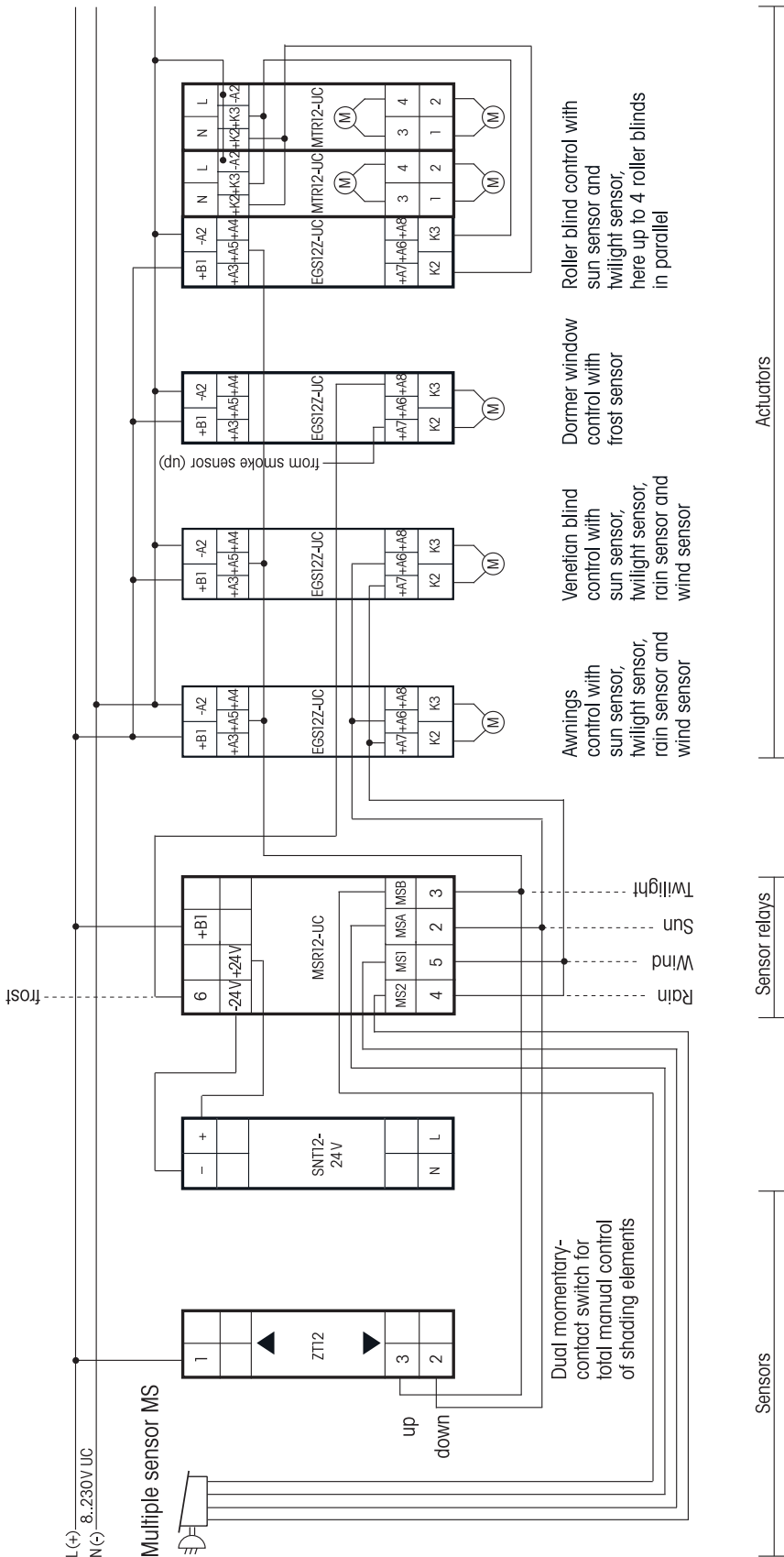

When controlling with 230 V (+B1=L, -A2=N) the 230 V motors are directly connected to K2, K3 and N. Otherwise motor isolating relays MTR12-UC must be interconnected to K2/K3. A night time window can be set with a digital time switch with 1 CO so that the multi sensor does not cause any disturbance. To do this, program the changeover as follows: in the daytime the terminal +B1 of MSR12-UC connect to L(+) and at night time L(+) direct to terminal 3 of MSR12-UC. This simulates twilight at the beginning of the time window in order to open all shading elements and at the same time all sensors are switched off.

TYPICAL CIRCUIT EXAMPLE OF A ROLLER SHUTTER CONTROL AND SHADING SYSTEM CONTROL

SHADING SYSTEM WITH THE LIGHT, TWILIGHT, RAIN AND WIND SENSOR RELAY LRW12D

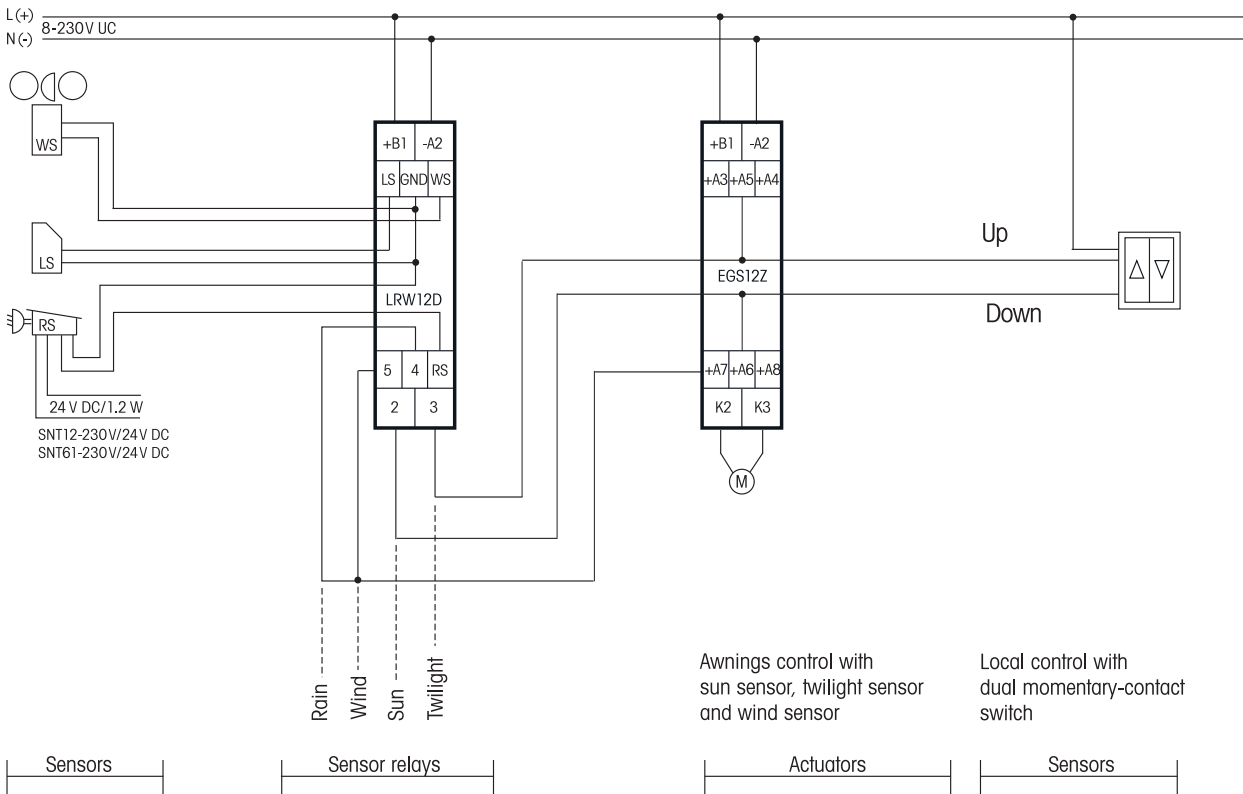

When controlling with 230 V (+B1= L, -A2=N) the 230 V awning motor is directly connected to K2, K3 and N. Otherwise a motor isolating relay MTR12-UC must be interconnected to K2/K3.

ROLLER SHUTTER CONTROL WITH EGS12Z2-UC

For clarity, the L and N connections for the 230 V motors are not shown.

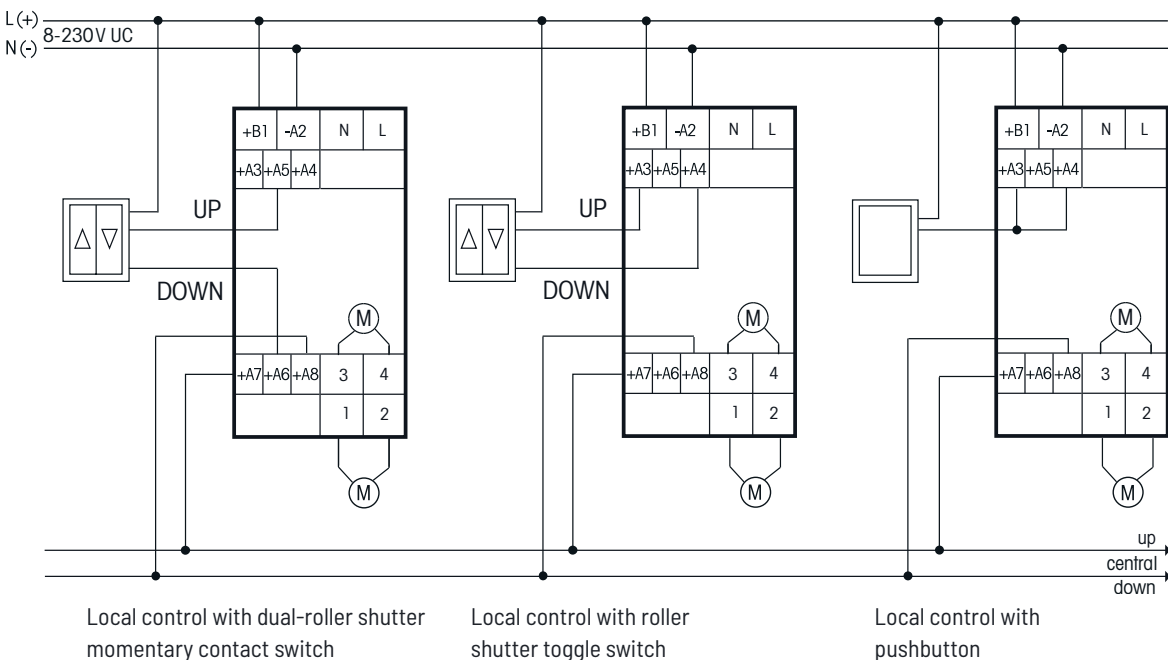

TYPICAL CIRCUIT EXAMPLES OF A ROLLER SHUTTER CONTROL

ROLLER SHUTTER CONTROL WITH EGS12Z-UC

For clarity, the L and N connections for the 230V motors are not shown.

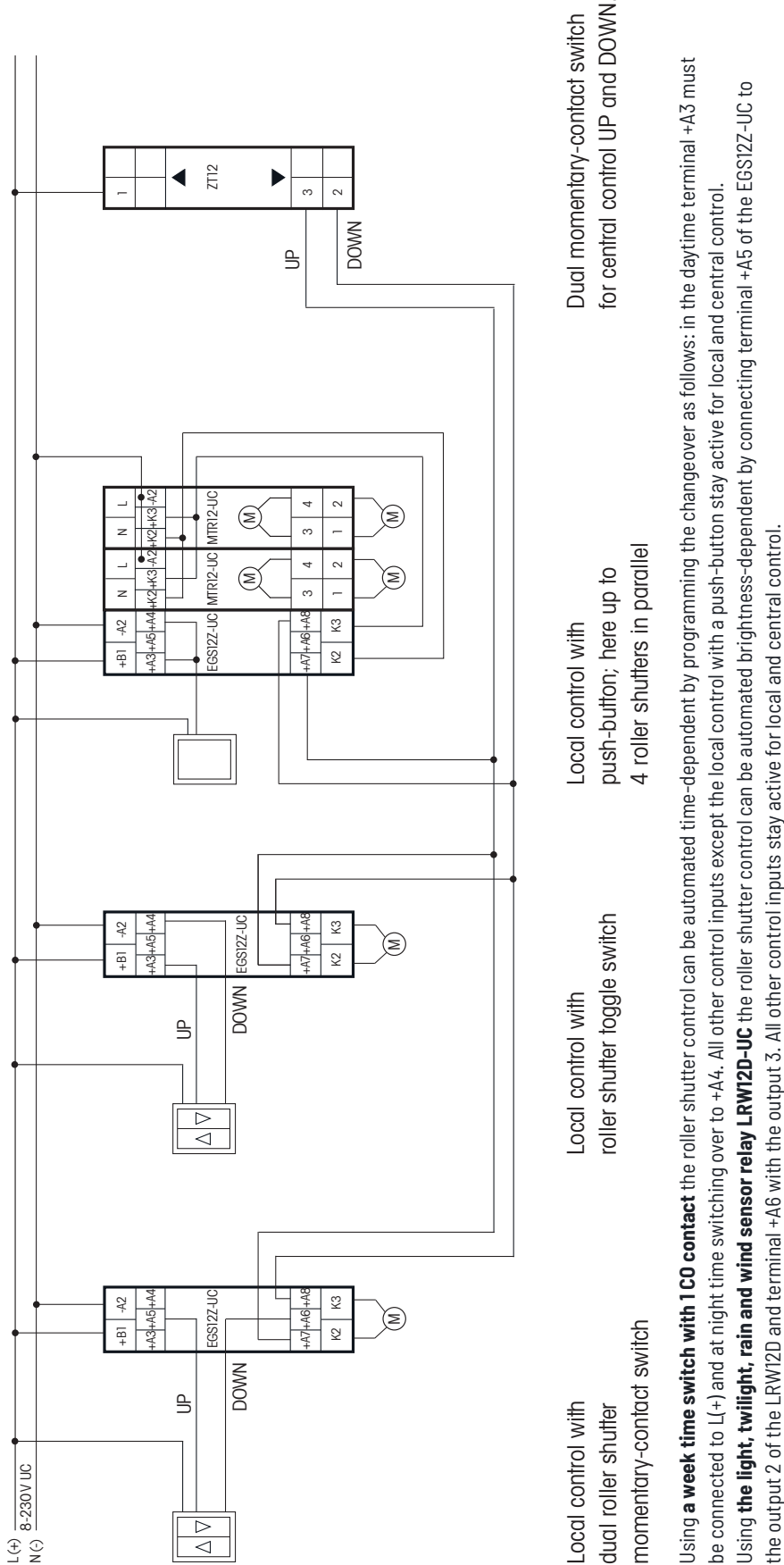

Local control with dual roller shutter momentary-contact switch
 Local control with roller shutter toggle switch
 Local control with push-button; here up to 4 roller shutters in parallel
 Dual momentary-contact switch for central control UP and DOWN.

Using a **week time switch with 1 CO contact** the roller shutter control can be automated time-dependent by programming the changeover as follows: in the daytime terminal +A3 must be connected to L (+) and at night time switching over to +A4. All other control inputs except the local control with a push-button stay active for local and central control. Using the **light, twilight, rain and wind sensor relay LRW12D-UC** the roller shutter control can be automated brightness-dependent by connecting terminal +A5 of the EGS12Z-UC to the output 2 of the LRW12D and terminal +A6 with the output 3. All other control inputs stay active for local and central control.

**WNT15
WNT15U
WNT61**



**WIDE RANGE SWITCHING POWER SUPPLY
- LOW STANDBY CONSUMPTION AND HIGH
EFFICIENCY**

Switching power supply units and wide-range switching power supply units

NEW Universal wide range power supply unit WNT15U/3,3-12V DC	17-2
NEW Wide range switching power supply WNT15	17-3
Switching power supply units SNT14	17-6
NEW Switching power supply units WNT6I	17-7
Technical data switching power supply units and wide range switching power supply units	17-8

UNIVERSAL WIDE RANGE POWER SUPPLY UNIT WNT15U/3,3-12V DC



Function rotary switch

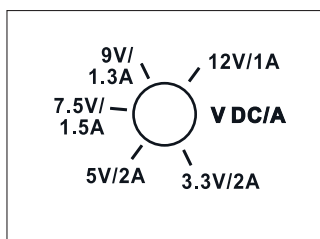

Manuals and documents in further languages:
http://eltako.com/redirect/WNT15U*3*3-12VDC

Technical data page 17-6.

WNT15U/3,3-12V DC



Universal wide range power supply unit. With 5 adjustable output voltages 3,3V/2 A, 5 V/2 A, 7,5 V/1,5 A, 9 V/1,3 A, 12 V/1 A. Standby loss 0.1 watt only.

Modular devices for DIN 60715 TH35 rail mounting.

1 module = 18 mm wide, 58 mm deep.

At a load of more than 50 % of the rated capacity and always if there are adjacent switching power supply units from 12W rated capacity and if there are dimmers a ventilation clearance of ½ module must be maintained with the spacers DS12 on both sides.

Wide range input voltage 88-264V AC (110V -20% to 240V +10%).

Stabilised output voltage ±1%, low residual ripple.

Short-circuit proof.

Overload protection and over-temperature switch-off by means of switching off with automatic switching-on after fault clearance (autorecovery function).

WNT15U/3,3-12V DC	Universal wide range power supply unit	Art. No. 20000175	60,00 €/pc.
--------------------------	--	--------------------------	--------------------

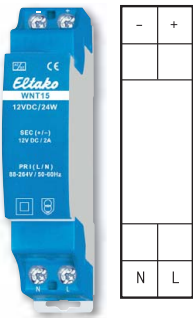

Manuals and documents in further languages:
http://eltako.com/redirect/WNT15-12VDC*24W

Technical data page 17-6.

WNT15-12VDC/24W



Wide range switching power supply unit. Rated capacity 24 W. Standby loss 0.1 watt only.

Modular devices for DIN 60715 TH35 rail mounting.

1 module = 18 mm wide, 58 mm deep.

At a load of more than 50% of the rated capacity and always if there are adjacent switching power supply units and if there are dimmers a ventilation clearance of 1/2 module must be maintained with the spacers DS12 on both sides.

Wide range input voltage 88-264 V AC (110 V -20% up to 240 V +10%).

Efficiency 91%. Stabilised output voltage $\pm 1\%$, low residual ripple. Short-circuit proof.

Overload protection and over-temperature switch-off by means of switching off with automatic switching-on after fault clearance (autorecovery function).

WNT15-12VDC/24W	Wide range switching power supply unit 12 V DC	Art. No. 20000072	52,50 €/pc.
-----------------	--	-------------------	-------------

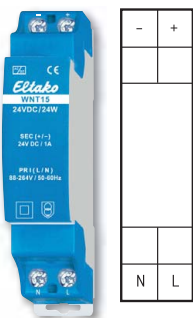

Manuals and documents in further languages:
http://eltako.com/redirect/WNT15-24VDC*24W

Technical data page 17-6.

WNT15-24VDC/24W



Wide range switching power supply unit. Rated capacity 24 W. Standby loss 0.1 watt only.

Modular devices for DIN 60715 TH35 rail mounting.

1 module = 18 mm wide, 58 mm deep.

At a load of more than 50% of the rated capacity and always if there are adjacent switching power supply units and if there are dimmers a ventilation clearance of 1/2 module must be maintained with the spacers DS12 on both sides.

Wide range input voltage 88-264 V AC (110 V -20% up to 240 V +10%).

Efficiency 91%. Stabilised output voltage $\pm 1\%$, low residual ripple. Short-circuit proof.

Overload protection and over-temperature switch-off by means of switching off with automatic switching-on after fault clearance (autorecovery function).

WNT15-24VDC/24W	Wide range switching power supply unit 24 V DC	Art. No. 20000073	52,50 €/pc.
-----------------	--	-------------------	-------------

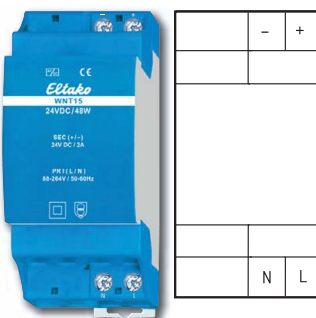

Manuals and documents in further languages:
http://eltako.com/redirect/WNT15-24VDC*48W

Technical data page 17-6.

WNT15-24VDC/48W



Wide range switching power supply unit. Rated capacity 48 W. Standby loss 0.2 watt only.

Modular devices for DIN 60715 TH35 rail mounting.

2 modules = 36 mm wide, 58 mm deep.

At a load of more than 50% of the rated capacity and always if there are adjacent switching power supply units and if there are dimmers a ventilation clearance of 1/2 module must be maintained with the spacers DS12 on both sides.

Wide range input voltage 88-264 V AC (110 V -20% up to 240 V +10%).

Efficiency 91%. Stabilised output voltage $\pm 1\%$, low residual ripple. Short-circuit proof.

Overload protection and over-temperature switch-off by means of switching off with automatic switching-on after fault clearance (autorecovery function).

WNT15-24VDC/48W	Wide range switching power supply unit 24V DC	Art. No. 20000075	61,80 €/pc.
-----------------	---	-------------------	-------------



Manuals and documents in further languages:
http://eltako.com/redirect/SNT14-24V*24W

Technical data page 17-6.

SNT14-24V/24W



Switching power supply unit. Rated capacity 24 W. Standby loss 0.1 watt only.

Modular devices for DIN 60715 TH35 rail mounting.

1 module = 18 mm wide, 58 mm deep.

At a load of more than 50% of the rated capacity and always if there are adjacent switching power supply units from 12 W rated capacity and if there are dimmers a ventilation clearance of 1/2 module must be maintained with the spacers DS12 on both sides.

Wide range input voltage 88-264V AC (110V -20% to 240V +10%).

Efficiency 91%. Stabilised output voltage $\pm 1\%$, low residual ripple. Short-circuit proof.

Overload protection and over-temperature switch-off by means of switching off with automatic switching-on after fault clearance (autorecovery function).

SNT14-24V/24W	Switching power supply unit 24 V DC	Art. No. 30014032	56,40 €/pc.
----------------------	-------------------------------------	--------------------------	--------------------

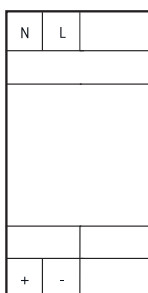

Manuals and documents in further languages:
http://eltako.com/redirect/SNT14-24V*48W

Technical data page 17-8.

SNT14-24V/48W



Switching power supply unit. Rated capacity 48 W. Standby loss 0.2 watt only.

Modular devices for DIN 60715 TH35 rail mounting.

2 modules = 36 mm wide, 58 mm deep.

At a load of more than 50% of the rated capacity and always if there are adjacent switching power supply units from 12 W rated capacity and if there are dimmers a ventilation clearance of 1/2 module must be maintained with the spacers DS12 on both sides.

Wide range input voltage 88-264V AC (110V -20% to 240V +10%).

Efficiency 92%. Stabilised output voltage $\pm 1\%$, low residual ripple. Short-circuit proof.

Overload protection and over-temperature switch-off by means of switching off with automatic switching-on after fault clearance (autorecovery function).

SNT14-24V/48W	Switching power supply unit 24 V DC	Art. No. 30014033	84,40 €/pc.
----------------------	-------------------------------------	--------------------------	--------------------

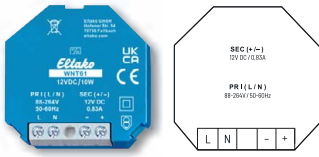

Manuals and documents in further languages:
http://eltako.com/redirect/WNT61-12VDC*10W

Technical data page 17-6.

WNT61-12VDC/10W



Wide range switching power supply unit. Rated capacity 10 W. Standby loss 0.1 watt only.

Built-in device for installation. 45 mm long, 45 mm wide, 33 mm deep.

Wide range input voltage 88-264 V AC (110 V -20% up to 240 V +10%).

Efficiency 86%.

Stabilised output voltage $\pm 1\%$, low residual ripple.

Short-circuit proof.

Overload protection and over-temperature switch-off by means of switching off with automatic switching-on after fault clearance (autorecovery function).

WNT61-12VDC/10W	Wide range switching power supply unit 12V DC	Art. No. 61000264	47,20 €/pc.
------------------------	---	--------------------------	--------------------

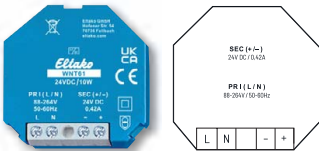

Manuals and documents in further languages:
http://eltako.com/redirect/WNT61-24VDC*10W

Technical data page 17-6.

WNT61-24VDC/10W



Wide range switching power supply unit. Rated capacity 10 W. Standby loss 0.1 watt only.

Built-in device for installation. 45 mm long, 45 mm wide, 33 mm deep.

Wide range input voltage 88-264 V AC (110 V -20% up to 240 V +10%).

Efficiency 86%.

Stabilised output voltage $\pm 1\%$, low residual ripple.

Short-circuit proof.

Overload protection and over-temperature switch-off by means of switching off with automatic switching-on after fault clearance (autorecovery function).

WNT61-24VDC/10W	Wide range switching power supply unit 24V DC	Art. No. 61000265	47,20 €/pc.
------------------------	---	--------------------------	--------------------

TECHNICAL DATA

SWITCHING POWER SUPPLY UNITS AND WIDE RANGE SWITCHING POWER SUPPLY UNITS

Type	WNT61-12VDC/10W	WNT61-24VDC/10W	WNT15U	WNT15-12V DC-24W	SNT14-24V/24W WNT15-24V DC-24W	WNT15-24V DC-48W SNT14-24V/48W
Output wattage	10 W ¹⁾	10 W ¹⁾	12 W ²⁾⁵⁾	24 W ²⁾	24 W ²⁾	48 W ²⁾
Output voltage, tolerance ±	12 V DC, ±1%	24 V DC, ±1%	3.3-12 V DC, ±1%	12 V DC, ±1%	24 V DC, ±1%	24 V DC, ±1%
Output current	0.83 A	0.42 A	1 A	2 A	1 A	2 A
Standby loss	0.1W	0.1W	0.1W	0.1W	0.1W	0.2 W
Residual ripple	< 100mV	< 100mV	< 100mV	< 100mV	< 100mV	< 100mV
Class of protection	II	II	II	II	II	II
Protection degree	IP 20	IP 20	IP 20	IP 20	IP 20	IP 20
Starting current ³⁾	18 A/230 V	18 A/230 V	18 A/230 V	18 A/230 V	18 A/230 V	18 A/230 V
Efficiency	86%	86%	86%	91%	91%	92%
Overload protection short-term	160-200%	160-200%	160-200%	160-200%	160-200%	160-200%
Overvoltage protection	140-170%	140-170%	140-170%	140-170%	140-170%	140-170%
Short-circuit proof ⁴⁾	yes	yes	yes	yes	yes	yes
Over-temperature protection ⁴⁾	yes	yes	yes	yes	yes	yes
Switchable in parallel, number	-	-	-	2	2	-
Size	45 x 45 x 33 mm	45 x 45 x 33 mm	1 PU, 18 mm	1 PU, 18 mm	1 PU, 18 mm	2 PU, 36 mm
Operating temperature °C	-10/+50	-10/+50	-10/+50	-10/+50	-10/+50	-10/+50

¹⁾ Even at full load a ventilation clearance is not necessary.

²⁾ At a load of more than 50% of the rated capacity and always if there are adjacent switching power supply units from 12 W rated capacity and if there are dimmers a ventilation clearance of 1/2 module must be maintained with the spacers DS12 on both sides.

³⁾ If connected on the primary side, 2 ms.

⁴⁾ With autorecovery function after fault clearance.

⁵⁾ WNT15U/3,3-12V DC only at 12 V DC.

To comply with DIN VDE 0100-443 and DIN VDE 0100-534, a Type 2 or Type 3 surge protection device (SPD) must be installed.

S12-220
S12-100
S91-100



**ELECTROMECHANICAL IMPULSE SWITCHES –
POLE POSITION S.**

18

Electromechanical impulse switches

1- and 2-pole electromechanical impulse switches S12	18 - 2
2-pole electromechanical impulse multicircuit switches SS12	18 - 2
Electromechanical 16 A impulse switches 1-pole S09, 4-pole S12	18 - 3
Auxiliary contact KM12	18 - 3
1- and 2-pole impulse switches S91 and S81	18 - 4
1-, 2- and 4-pole electromechanical 25 A impulse switches XS12	18 - 5
Switch positions of electromechanical impulse switches, comparable electronic types	18 - 6
Technical data electromechanical impulse switches	18 - 7

1- AND 2-POLE ELECTROMECHANICAL IMPULSE SWITCHES S12
2-POLE ELECTROMECHANICAL IMPULSE MULTICIRCUIT SWITCHES SS12

POLE POSITION S

When we introduced the first Eltako impulse switches in 1949, they were already standing in the pole position in Europe and since then we have defended this position time and again with innovative

products, highest quality, best possible service and attractive prices. Then, impulse switches were also called impulse relays, step switches or latching relays.



S12-100-230 V



Manuals and documents in further languages:
http://eltako.com/redirect/S12-100-*200-*110

Technical data page 18-7.

S12-100-/200-/110-

1- and 2-pole 16 A/250 V AC

Modular devices for DIN 60715 TH35 rail mounting with manual control and switch position indicator.

1 module = 18 mm wide, 55 mm deep.

100% time on. Control power demand 5-6 W only. Contacts 1 NO, 2 NO, 1 NO + 1 NC. Contact gap 3 mm.

Spacing of control connections/contact > 6 mm.

Devices for 25 A XS12, page 18-5. Retrofittable auxiliary contact KM12, page 18-3.

The pin-compatible ES12DX-UC, ES12-200-UC and ES12-110-UC electronic impulse switches can also be used.

Their universal control voltage UC covers the voltage ranges of 12 to 230 V AC at 50-60Hz and 12 to 230 V DC.

S12-100-12V	1 NO 16 A	Art. No. 21100011	31,00 €/pc.
S12-100-230V	1 NO 16 A	Art. No. 21100030	31,00 €/pc.
S12-100-8V, 24V, 12V DC, 24V DC	1 NO 16 A	Art. No. 21100010, 21100020, 21100054, 21100055	33,50 €/pc.
S12-200-12V	2 NO 16 A	Art. No. 21200011	39,40 €/pc.
S12-200-230V	2 NO 16 A	Art. No. 21200030	39,40 €/pc.
S12-200-8V, 24V, 12V DC, 24V DC	2 NO 16 A	Art. No. 21200010, 21200020, 21200054, 21200055	41,50 €/pc.
S12-110-12V	1 NO + 1 NC 16 A	Art. No. 21110011	39,40 €/pc.
S12-110-230V	1 NO + 1 NC 16 A	Art. No. 21110030	39,40 €/pc.
S12-110-8V, 24V, 12V DC, 24V DC	1 NO + 1 NC 16 A	Art. No. 21110010, 21110020, 21110054, 21110055	41,50 €/pc.

SS12-110-

Impulse multicircuit switch, 1+1 NO contacts 16 A/250 V AC

Modular devices for DIN 60715 TH35 rail mounting with manual control and switch position indicator.

1 module = 18 mm wide, 55 mm deep.

100% time on. Control power demand 5-6 W.

Contact gap 3 mm. Spacing of control connections/contact > 6 mm.

The ESR12DDX-UC electronic impulse switch can also be used.

The universal control voltage UC covers the voltage ranges of 12 to 230 V AC at 50-60Hz and 12 to 230 V DC.

SS12-110-12V	1 + 1 NO 16 A	Art. No. 21110211	46,00 €/pc.
SS12-110-230V	1 + 1 NO 16 A	Art. No. 21110230	46,00 €/pc.



SS12-110-230V



Manuals and documents in further languages:
<http://eltako.com/redirect/SS12-110>

Technical data page 18-7.

Recommended retail prices excluding VAT.

ELECTROMECHANICAL 16 A IMPULSE SWITCHES 1-POLE S09, 4-POLE S12 AND CONTACT MODULE KM12



S09-230V



Manuals and documents in further languages:
<http://eltako.com/redirect/S09>

Technical data page 18-7.

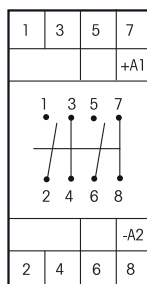

S12-220-230V



Manuals and documents in further languages:
http://eltako.com/redirect/S12-400-*310-*220

Technical data page 18-7.



Manuals and documents in further languages:
<http://eltako.com/redirect/KM12>

S09-

1 NO contact 16 A/230 V AC

Modular devices for DIN 60715 TH35 rail mounting with manual control and switch position indicator.

Only ½ module = 9 mm wide, 55 mm deep.

Control power demand 5 W. For impulse control.

Contact gap 3 mm.

S09-12V	1 NO 16 A	Art. No. 29100011	33,40 €/pc.
S09-230V	1 NO 16 A	Art. No. 29100030	36,40 €/pc.

S12-400-/310-/220-

4-pole 16 A/250 V AC

Modular devices for DIN 60715 TH35 rail mounting with manual control and switch position indicator, for impulse control.

2 modules = 36 mm wide, 55 mm deep.

Time on: **impulse control only**. Control power demand 12-15 W.

Contacts: 4 NO, 3 NO + 1 NC, 2 NO + 2 NC.

Contact gap 3 mm.

Devices for 25 A XS12, page 18-5.

Retrofittable auxiliary contact KM12.

S12-400-230V	4 NO 16 A	Art. No. 21400030	57,20 €/pc.
S12-310-230V	3 NO + 1 NC 16 A	Art. No. 21310030	57,20 €/pc.
S12-220-230V	2 NO + 2 NC 16 A	Art. No. 21220030	57,20 €/pc.

KM12

Contact module, 1 NO contact and 1 NC contact 4 A/250 V AC

Retrofittable to the left of all impulse switches S12 and XS12 as well as switching relays and installation contactors R12 and XR12.

½ module = 9 mm wide.

KM12	Auxiliary contact 1 NO + 1 NC, 4 A	Art. No. 20000030	17,10 €/pc.
------	------------------------------------	-------------------	-------------

1- AND 2-POLE IMPULSE SWITCHES S91 AND S81

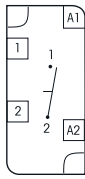

S91-100-230 V



Manuals and documents in further languages:
<http://eltako.com/redirect/S91-100->

Technical data page 18-7.
 Mounting accessories chapter Z.

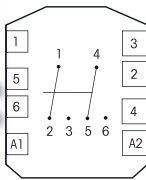

S81-002-230V



Manuals and documents in further languages:
<http://eltako.com/redirect/S81-002-230V>

Technical data page 18-7.
 Mounting accessories chapter Z.

S91-100-

1 NO contact 10 A/250 V AC

Built-in devices for installation and surface mounting. With manual control and switch position indicator.
 50 mm long, 26 mm wide, 32 mm deep.

Time on 100%. Control power demand 2,5 W. Contact gap 2 mm.

The ES61-UC electronic impulse switch can also be used.

The universal control voltage UC covers the voltage ranges of 12 to 230 V AC at 50-60 Hz and 12 to 230 V DC.

S91-100-230V	1 NO 10 A	Art. No. 91100030	31,70 €/pc.
S91-100-12V	1 NO 10 A	Art. No. 91100011	31,00 €/pc.
S91-100-8V	1 NO 10 A	Art. No. 91100010	35,00 €/pc.

S81-002-230V

2 CO contacts 10 A/250 V AC

Built-in devices for installation and surface mounting.

With manual control and switch position indicator.

50 mm long, 42 mm wide, 32 mm deep.

Time on 100%.

Control power demand 5 W.

Contact gap 2 mm.

S81-002-230V	2 CO 10 A	Art. No. 81002030	38,60 €/pc.
---------------------	-----------	--------------------------	--------------------



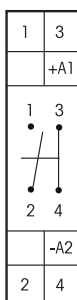

XS12-110-230V



Manuals and documents in further languages:
http://eltako.com/redirect/XS12-100-*200-*110-

Technical data page 18-7.

XS12-100-/200-/110-

1- and 2-pole, 25 A/250 V AC

Modular devices for DIN 60715 TH35 rail mounting with manual control and switch position indicator.

1 module = 18 mm wide, 55 mm deep.

100% time on. Control power demand 5-6 W.

Contacts: 1 NO, 2 NO, 1 NO + 1 NC.

Contact gap 3 mm.

Retrofittable auxiliary contact KM12, page 18-3.

XS12-100-230V	1 NO 25 A	Art. No. 21100930	36,10 €/pc.
XS12-200-230V	2 NO 25 A	Art. No. 21200930	43,90 €/pc.
XS12-110-230V	1 NO + 1 NC 25 A	Art. No. 21110930	43,90 €/pc.

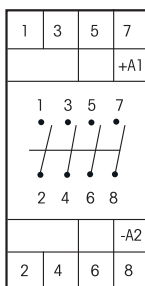

XS12-400-230V



Manuals and documents in further languages:
http://eltako.com/redirect/XS12-400-*310-*220-

Technical data page 18-7.

XS12-400-/310-/220-

4-pole 25 A/250 V AC

Modular devices for DIN 60715 TH35 rail mounting with manual control and switch position indicator, for impulse control.

2 modules = 36 mm wide, 55 mm deep.

Time on: **impulse control only**. Control power demand 12-15 W.

Contacts: 4 NO, 3 NO + 1 NC, 2 NO + 2 NC.

Contact gap 3 mm.

Retrofittable auxiliary contact KM12, page 18-3.

XS12-400-230V	4 NO 25 A	Art. No. 21400930	60,20 €/pc.
XS12-310-230V	3 NO + 1 NC 25 A	Art. No. 21310930	60,20 €/pc.
XS12-220-230V	2 NO + 2 NC 25 A	Art. No. 21220930	60,20 €/pc.



SWITCH POSITIONS OF ELECTROMECHANICAL IMPULSE SWITCHES COMPARABLE ELECTRONIC TYPES

CONTACTS	TYPE	CONTACTS	TYPE
<p>1 NO contact</p>	<p>S12-100- XS12-100- S91-100-</p>	<p>2 CO contacts</p>	<p>S81-002</p>
<p>2 NO contacts</p>	<p>S12-200- XS12-200-</p>		
<p>1 NO contact + 1 NC contact</p>	<p>S12-110- XS12-110-</p>		
<p>Multicircuit switch 1+1 NO contacts</p>	<p>SS12-110-</p>		
<p>4 NO contacts</p>	<p>XS12-400-</p>		
<p>3 NO contacts + 1 NC contact</p>	<p>XS12-310-</p>		
<p>2 NO contacts + 2 NC contact</p>	<p>XS12-220-</p>		

Comparable electronic types	
ES12DX-UC	replaces terminal compatible the S12-100- , all control voltages
ES12-200-UC	replaces terminal compatible the S12-200- , all control voltages
ES12-110-UC	replaces terminal compatible the S12-110- , all control voltages
ESR12DDX-UC	replaces the SS12-110- , all control voltages
ES61-UC	replaces the S91-100- , all control voltages
ESR61M-UC	replaces S81- , SS81- and GS81- , all control voltages

Type	S09/S12/SS12	S91/S81	XS12
Contacts			
Contact material/contact gap	AgSnO ₂ /3 mm	AgSnO ₂ /2 mm	AgSnO ₂ /3 mm ¹⁾
Spacing of control connections/contact	> 6 mm	> 6 mm	> 6 mm
Test voltage contact/contact	2000 V	2000 V	2000 V
Test voltage control connections/contact	4000 V	4000 V	4000 V
Rated switching capacity	16 A/250 V AC 10 A/400 V AC	10 A/250 V AC 6 A/400 V AC	25 A/250 V AC 16 A/400 V AC
230 V LED lamps	up to 200 W ⁵⁾	up to 200 W ⁵⁾	up to 200 W ⁵⁾
Incandescent lamp and halogen lamp load ²⁾ 230 V	2300 W	2300 W	2300 W
Fluorescent lamp load with KVG* in lead-lag circuit or non compensated	2300 VA	2300 VA	3600 VA
Fluorescent lamp load with KVG* shunt-compensated or with EVG*	500 VA	500 VA	1000 VA
Compact fluorescent lamps with EVG* and energy saving lamps ESL	I on ≤ 140 A/10 ms ³⁾	I on ≤ 70 A/10 ms ³⁾	I on ≤ 140 A/10 ms ³⁾
HQI and HQI non compensated	500 W	-	500 W
Max. switching current DC1: 12 V/24 V DC	8 A	8 A	12 A
Life at rated load cos φ = 1 or incandescent lamps 1000 W at 100/h	> 10 ⁵	> 10 ⁵	> 10 ⁵
Life at rated load, cos φ = 0.6 at 100/h	> 4x10 ⁴	> 4x10 ⁴	> 4x10 ⁴
Max. operating cycles	10 ³ /h	10 ³ /h	10 ³ /h
Switch position indication	yes	yes	yes
Manual control	yes	yes	yes
Maximum conductor cross-section	6 mm ²	4 mm ²	6 mm ²
Two conductors of same cross-section	2.5 mm ²	1.5 mm ²	2.5 mm ²
Screw head	slotted/crosshead, pozidriv	slotted/crosshead, pozidriv	slotted/crosshead, pozidriv
Type of enclosure/terminals	IP50/IP20	IP50/IP20	IP50/IP20
Solenoid			
Time on at rated voltage 1- and 2-pole, without S09	100% ⁴⁾	100%	100% ⁴⁾
Time on at rated voltage 4-pole as well as S09	impulse control	-	impulse control
Max./min. temperature at mounting location	+50°C/-5°C	+50°C/-5°C	+50°C/-5°C
Control voltage range	0.9 to 1.1 x rated voltage	0.9 to 1.1 x rated voltage	0.9 to 1.1 x rated voltage
Coil power loss AC+ DC ±20%	1- and 2-pole 5 - 6 W; 4-pole 12 - 15 W	S81: 5 W S91: 2.5 W	1- and 2-pole 5 - 6 W; 4-pole 12 - 15 W
Min. command duration	50 ms	50 ms	50 ms
Max. parallel capacitance (length) of single control lead at 230 V AC	0.06 μF (approx. 200 m)	0.06 μF (approx. 200 m)	0.06 μF (approx. 200 m)
Max. voltage induced at the control inputs	0.2 x rated voltage	0.2 x rated voltage	0.2 x rated voltage
Glow lamps in parallel with the 230 V control switches	5 mA	5 mA	5 mA
With 1 μF/250 V AC capacitor in parallel with coil	10 mA	10 mA	10 mA
With 2.2 μF/250 V AC capacitor in parallel with coil	15 mA	15 mA	15 mA

* EVG = electronic ballast units; KVG = conventional ballast units

¹⁾ Contact distance of the NC contacts 1.2 mm.

²⁾ For lamps with 150 W max.

³⁾ A 40-fold inrush current must be calculated for electronic ballast devices. For steady loads of 1200 W or 600 W use the current-limiting relay SBR12 or SBR61. See chapter 14, page 14-8.

⁴⁾ Whenever several impulse switches are continuously energised make sure there is adequate ventilation and, in addition, a ventilation clearance of approx. half a module. Use the DS12 spacer as necessary.

⁵⁾ Due to different lamp electronics and depending on the manufacturer, the maximum number of lamps may be limited, especially if the wattage of the individual lamps is very low (e.g. with 2 W LEDs).

To comply with DIN VDE 0100-443 and DIN VDE 0100-534, a Type 1 or Type 2 surge protection device (SPD) must be installed.

R12-400
R12-100
R91-100



**ELECTROMECHANICAL SWITCHING RELAYS
AND INSTALLATION CONTACTORS - POLE
POSITION R.**

Electromechanical switching relays and installation contactors

1-, 2- and 4-pole electromechanical switching relays R12	19 - 2
1- and 2-pole electromechanical switching relays R91 and R81	19 - 3
1-, 2- and 4- pole 25 A electromechanical installation contactors XR12	19 - 4
Technical data electromechanical switching relays and installation contactors	19 - 5

1-, 2- AND 4-POLE ELECTROMECHANICAL SWITCHING RELAYS R12



R12-110-230V



Manuals and documents in further languages:
http://eltako.com/redirect/R12-100-*200-*110-*020-

Technical data page 19-5.

R12-100-/200-/110-/020-

1- and 2-pole 16 A/250 V AC

Modular devices for DIN 60715 TH35 rail mounting with manual control and switch position indicator.

1 module = 18 mm wide, 55 mm deep.

100% time on. Control power demand 1.9 W.

Contacts: 1 NO, 2 NO, 1 NO + 1 NC, 2 NC (closed-circuit current relay, 230 V only).

Contact gap 3 mm.

Contact/contact test voltage 2000 V and control connections/contact test voltage 4000 V.

25 A devices XR12, page 19-4. Retrofittable auxiliary contact KM12, page 18-3.

The pin-compatible ER12DX-UC, ER12-200-UC and ER12-110-UC electronic switching relays can also be used.

The universal control voltage UC covers the voltage ranges of 12 to 230 V AC at 50-60 Hz and 12 to 230 V DC.

R12-100-12V	1 NO 16 A	Art. No. 22100011	31,00 €/pc.
R12-100-230V	1 NO 16 A	Art. No. 22100030	31,00 €/pc.
R12-100-8V, 24V, 12V DC, 24V DC	1 NO 16 A	Art. No. 22100010, 22100020, 22100054, 22100055	33,50 €/pc.
R12-200-12V	2 NO 16 A	Art. No. 22200011	39,40 €/pc.
R12-200-230V	2 NO 16 A	Art. No. 22200030	39,40 €/pc.
R12-200-8V, 24V, 12V DC, 24V DC	2 NO 16 A	Art. No. 22200010, 22200020, 22200054, 22200055	41,50 €/pc.
R12-110-12V	1 NO + 1 NC 16 A	Art. No. 22110011	39,40 €/pc.
R12-110-230V	1 NO + 1 NC 16 A	Art. No. 22110030	39,40 €/pc.
R12-110-8V, 24V, 12V DC, 24V DC	1 NO + 1 NC 16 A	Art. No. 22110010, 22110020, 22110054, 22110055	41,50 €/pc.
R12-020-230V	2 NC 16 A	Art. No. 22020030	40,60 €/pc.

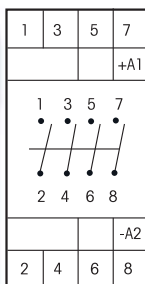

R12-400-230V



Manuals and documents in further languages:
http://eltako.com/redirect/R12-400-*310-*220-

Technical data page Seite 19-5.

R12-400-/310-/220-

4-pole 16 A/250 V AC

Modular devices for DIN 60715 TH35 rail mounting with manual control and switch position indicator.

2 modules = 36 mm wide, 55 mm deep.

100% time on. Control power demand 4 W.

Contacts: 4 NO, 3 NO + 1 NC, 2 NO + 2 NC.

Contact gap 3 mm.

Contact/contact test voltage 2000 V and control connections/contact test voltage 4000 V.

25 A devices XR12, page 19-4. Retrofittable auxiliary contact KM12, page 18-3.

R12-400-230V	4 NO 16 A	Art. No. 22400030	58,90 €/pc.
R12-310-230V	3 NO + 1 NC 16 A	Art. No. 22310030	58,90 €/pc.
R12-220-230V	2 NO + 2 NC 16 A	Art. No. 22220030	58,90 €/pc.



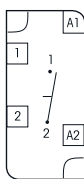

R91-100-230V



Manuals and documents in further languages:
<http://eltako.com/redirect/R91-100->

Technical data page 19-5.

R91-100-

1 NO contact 10 A/250 V AC

Built-in devices for installation and surface mounting.

50 mm long, 26 mm wide, 32 mm deep.

Time on 100%. Control power demand 2.5 W.

Contact gap 2 mm.

Contact/contact test voltage 2000 V and control connection/contact test voltage 4000 V.

The ER61-UC electronic switching relay can also be used.

The universal control voltage UC covers the voltage ranges of 12 to 230 V AC at 50-60 Hz and 12 to 230 V DC.

R91-100-230V	1 NO 10 A	Art. No. 91100430	31,70 €/pc.
R91-100-12V	1 NO 10 A	Art. No. 91100411	31,00 €/pc.
R91-100-8V	1 NO 10 A	Art. No. 91100410	35,00 €/pc.

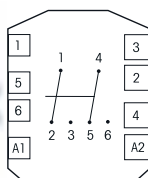

R81-002-230V



Manuals and documents in further languages:
<http://eltako.com/redirect/R81-002-230V>

Technical data page 19-5.

R81-002-

2 CO contacts 10 A/250 V AC

Built-in devices for installation and surface mounting.

50 mm long, 42 mm wide, 32 mm deep.

Time on 100%. Control power demand 5 W.

Contact gap 2 mm.

Contact/contact test voltage 2000 V and control connection/contact test voltage 4000 V.

R81-002-230V	2 CO 10 A	Art. No. 81002430	38,60 €/pc.
---------------------	-----------	--------------------------	--------------------



Comparable electronic types	
ER12DX-UC	replaces terminal compatible the R12-100- , all control voltages
ER12-200-UC	replaces terminal compatible the R12-200- , all control voltages
ER12-110-UC	replaces terminal compatible the R12-110- , all control voltages
ER61-UC	replaces the R91-100- , all control voltages
ESR61M-UC	replaces partially the R81 , all control voltages

1-, 2- AND 4- POLE 25 A ELECTROMECHANICAL INSTALLATION CONTACTORS XR12



XR12-110-230V



Manuals and documents in further languages:
http://eltako.com/redirect/XR12-100-*200-*110-

Technical data page 19-5.

XR12-100-/200-/110-

1- and 2-pole, 25 A/250 V AC

Modular devices for DIN 60715 TH35 rail mounting with manual control and switch position indicator.

1 module = 18 mm wide, 55 mm deep.

100% time on. Control power demand 1.9 W.

Contacts 1 NO, 2 NO, 1 NO + 1 NC.

Contact gap 3 mm.

Contact/contact test voltage 2000 V and control connection/contact test voltage 4000 V.

Retrofittable auxiliary contact KM12, page 18-3.

XR12-100-230V	1 NO 25 A	Art. No. 22100930	37,20 €/pc.
XR12-200-230V	2 NO 25 A	Art. No. 22200930	45,50 €/pc.
XR12-110-230V	1 NO + 1 NC 25 A	Art. No. 22110930	45,50 €/pc.

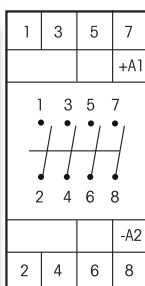

XR12-400-230V



Manuals and documents in further languages:
http://eltako.com/redirect/XR12-400-*310-*220-

Technical data page 19-5.

XR12-400-/310-/220-

4-pole, 25A/250V AC

Modular devices for DIN 60715 TH35 rail mounting with manual control and switch position indicator.

2 modules = 36 mm wide, 55 mm deep.

100% time on. Control power demand 4 W.

Contacts: 4 NO, 3 NO + 1 NC, 2 NO + 2 NC.

Contact gap 3 mm.

Contact/contact test voltage 2000 V and control connection/contact test voltage 4000 V.

Retrofittable auxiliary contact KM12, page 18-3.

XR12-400-230V	4 NO 25 A	Art. No. 22400930	62,00 €/pc.
XR12-310-230V	3 NO + 1 NC 25 A	Art. No. 22310930	62,00 €/pc.
XR12-220-230V	2 NO + 2 NC 25 A	Art. No. 22220930	62,00 €/pc.

TECHNICAL DATA

ELECTROMECHANICAL SWITCHING RELAYS AND INSTALLATION CONTACTORS

Type	R12	R81/R91	XR12
Contacts			
Contact material/contact gap	AgSnO ₂ /3 mm	AgSnO ₂ /2 mm	AgSnO ₂ /3 mm ¹⁾
Spacing of control connections/contact	> 6 mm	> 6 mm	> 6 mm
Test voltage contact/contact	2000 V	2000 V	2000 V
Test voltage control connections/contact	4000 V	4000 V	4000 V
Rated switching capacity	16 A/250 V AC 10 A/400 V AC	10 A/250 V AC 6 A/400 V AC	25 A/250 V AC 16 A/400 V AC
230 V LED lamps	up to 200 W ⁵⁾	up to 200 W ⁵⁾	up to 200 W ⁵⁾
Incandescent lamp and halogen lamp load 230 V ²⁾	2300 W	2300 W	2300 W
Fluorescent lamp load with KVG* in lead-lag circuit or non compensated	2300 VA	2300 VA	3600 VA
Fluorescent lamp load with KVG* shunt-compensated or with EVG*	500 VA	500 VA	1000 VA
Compact fluorescent lamps with EVG* and energy saving lamps ESL	I on ≤ 140 A/10 ms ³⁾	I on ≤ 70 A/10 ms ³⁾	I on ≤ 140 A/10 ms ³⁾
HQL and HQL non compensated	500 W	-	500 W
Max. switching current DC1: 12 V/24 V DC	8 A	8 A	12 A
Life at rated load, cos φ = 1 or incandescent lamps 1000 W at 100/h	> 10 ⁵	> 10 ⁵	> 10 ⁵
Life at rated load, cos φ = 0.6 at 100/h	> 4x10 ⁴	> 4x10 ⁴	> 4x10 ⁴
Max. operating cycles	10 ³ /h	10 ³ /h	10 ³ /h
Closing time	10-20 ms	10-20 ms	10-20 ms
Opening time	5-15 ms	5-15 ms	5-15 ms
Switch position indication	yes	yes	yes
Manual control	yes	yes	yes
Maximum conductor cross-section	6 mm ²	4 mm ²	6 mm ²
Two conductors of same cross-section	2.5 mm ²	1.5 mm ²	2.5 mm ²
Screw head	slotted/crosshead, pozidriv	slotted/crosshead, pozidriv	slotted/crosshead, pozidriv
Type of enclosure/terminals	IP50/IP20	IP50/IP20	IP50/IP20
Solenoid System			
Time on	100% ⁴⁾	100%	100% ⁴⁾
Max./min. temperature at mounting location	+50°C/-5°C	+50°C/-5°C	+50°C/-5°C
Control voltage range	0.9 to 1.1 x rated voltage	0.9 to 1,1 x rated voltage	0.9 to 1.1 x rated voltage
Coil power loss AC+DC ±20%	1- and 2-pole: 1.9 W 4-pole: 4 W	R81: 5 W R91: 2,5 W	1- and 2-pole: 1,9 W 4-pole: 4 W
Total power loss with continuous excitation at rated voltage and rated contact load	1-pole: 4 W, 2-pole: 6 W 4-pole: 12 W	1-pole: 7 W 2-pole: 9 W	1-pole: 4 W, 2-pole: 6 W 4-pole: 12 W
Max. parallel capacitance (length) of control lead	0.06 μF (ca. 200 m)	0.06 μF (ca. 200 m)	0.06 μF (ca. 200 m)
Max. voltage induced at the control inputs	0.2 x rated voltage	0.2 x rated voltage	0.2 x rated voltage

* EVG = electronic ballast units; KVG = conventional ballast units.

¹⁾ Contact distance of the NC contacts 1.2 mm.

²⁾ Contact spacing of NC contacts 1.2 mm.

³⁾ A 40-fold inrush current must be calculated for electronic ballast devices. For steady loads of 1200 W or 600 W use the current-limiting relay SBR12 or SBR61. See chapter 14, page 14-8.

⁴⁾ Whenever several impulse switches are continuously energised make sure there is adequate ventilation as a function of the calculated power loss.

⁵⁾ Due to different lamp electronics and depending on the manufacturer, the maximum number of lamps may be limited, especially if the wattage of the individual lamps is very low (e.g. with 2 W LEDs).

To comply with DIN VDE 0100-443 and DIN VDE 0100-534, a Type 1 or Type 2 surge protection device (SPD) must be installed.

**UIB70
FPP12**



**ACCESSORIES – USEFUL HELPERS ABOUT
THE ELTAKO INSTALLATION.**

Accessories wireless and others

Universal installation box blue UIB70 and Universal installation box pure white UIB70-rw	Z-2
Spacer DS12 , spacer DS14 , socket outlet ST12-16A and universal double DIN rail mounting plate U2RP	Z-3
Wireless Powernet phase coupler FPP12	Z-4
Screws and rawls S+D25 , triple RC module RC12-230V and WET.PROTECT WP50	Z-5
Wireless Field Test Tool P10	Z-6
NEW Infrared transmitter IRT3	Z-7

ACCESSORIES

UNIVERSAL INSTALLATION BOX BLUE UIB70 AND UNIVERSAL INSTALLATION BOX PURE WHITE UIB70-RW



Manuals and documents in further languages:
<http://eltako.com/redirect/UIB70>



Manuals and documents in further languages:
<http://eltako.com/redirect/UIB70-rw>

UIB70

Universal installation box blue.

L x W x H: 70 x 56 x 37 mm.

For installing a device from the 61, 62, 64, 81 and 91 series..

Base plate for wall mounting with 4 holes for screw mounting, hole spacing 56 x 40 mm.

Housing for snapping onto the base plate, with ventilation slots, cable entry and cable strain relief with commercially available cable ties up to 2.6 mm. Protection class IP20.

UIB70	Universal installation box blue	Art. No. 30000011	12,80 €/pc.
-------	---------------------------------	-------------------	-------------

UIB70-rw

Universal installation box pure white.

L x W x H: 70 x 56 x 37 mm.

For installing a device from the 61, 62, 64, 81 and 91 series..

Base plate for wall mounting with 4 holes for screw mounting, hole spacing 56 x 40 mm.

Housing for snapping onto the base plate, with ventilation slots, cable entry and cable strain relief with commercially available cable ties up to 2.6 mm. Protection class IP20.

UIB70-rw	Universal installation box pure white	Art. No. 30000012	11,40 €/pc.
----------	---------------------------------------	-------------------	-------------



Manuals and documents in further languages:
<http://eltako.com/redirect/DS12>

DS12

Spacer

1/2 module wide = 9 mm, to produce and maintain a ventilation clearance for modular devices dissipating much heat, e.g. dimmers from 300 W/400 W and continuously rated electromechanical impulse switches.

DS12	Spacer	Art. No. 20000010	2,10 €/pc.
------	--------	-------------------	------------

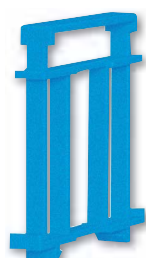

Manuals and documents in further languages:
<http://eltako.com/redirect/DS14>

DS14

Spacer

1/2 module wide = 9 mm, to produce and maintain a ventilation clearance for modular devices dissipating much heat, e.g. dimmers from 300 W/400 W and continuously rated electromechanical impulse switches.

DS14	Spacer	Art. No. 30014101	2,10 €/pc.
------	--------	-------------------	------------



Manuals and documents in further languages:
<http://eltako.com/redirect/ST12-16A>

ST12-16A

Socket outlet

Socket outlet 16 A as modular device for mounting on DIN-EN 60715 TH35 rail or as built-in device. 2.5 modules = 45 mm wide, 55 mm deep.

ST12-16A	Socket outlet	Art. No. 24100900	20,90 €/pc.
----------	---------------	-------------------	-------------



Rail mounting not included in the scope of supply.



Manuals and documents in further languages:
<http://eltako.com/redirect/U2RP>

U2RP

Universal DIN rail mounting plate for installation of 1 or 2 devices from the series 61, 62 and 62-IP in distributors and control cabinets on DIN-EN 60715 TH35 mounting rails. Attachment with pre-assembled adhesive pads. Additional fastening possible on site with cable ties.

U2RP	Universal double DIN rail mounting plate for series 61+62+62-IP, grey	Art. No. 30000018	6,00 €/pc.
------	---	-------------------	------------

ACCESSORIES

WIRELESS POWERNET PHASE COUPLER FPP12



Manuals and documents in further languages:
<http://eltako.com/redirect/FPP12>

FPP12



Wireless Powernet phase coupler to transmit wireless telegrams over the 230 V power mains. Only 0.2 watt standby loss.

Modular device for DIN-EN 60715 TH35 rail mounting.

1 module = 18 mm wide, 58 mm deep.

Voltage between the two outer conductors: 400 V/50 Hz.

Frequency range 115-132 kHz.

The phase coupler increases the capacitive coupling between 2 different outer conductors if, for example, the cables within the installation are not laid in parallel at a distance of at least several metres apart (as ribbon cables or jacketed cables).

Caution: The phase coupler may only be connected to the input side of the line circuit-breaker.

Typical connection

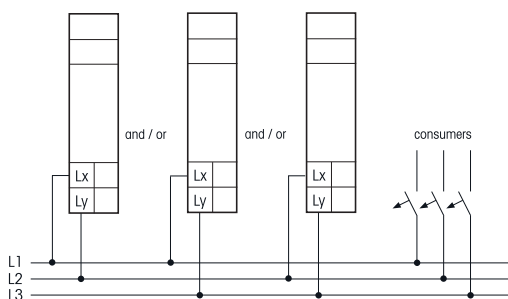

FPP12	Wireless Powernet phase coupler	Art. No. 30000051	34,00 €/pc.
-------	---------------------------------	-------------------	-------------

ACCESSORIES

SCREWS AND RAWL PLUGS S+D25, TRIPLE RC MODULE RC12-230V AND WET.PROTECT WP50



Manuals and documents in further languages:
http://eltako.com/redirect/S*D25

S+D 25

25 pcs screws and rawl plugs to fit the mounting plate for wireless pushbuttons. Screws also for fitting on UP boxes.

Contents: 25 pcs countersunk sheet metal screws with cross head 2.9x25 mm DIN 7982 C, stainless steel A2 and 25 pcs Fischer rawl plugs with lip SX5, 25 mm long.

The screw head fits exactly (in height and diameter) between the mounting plate of the wireless pushbutton and the Eltako frame.

Moreover, the screws are also suitable for fixing devices on UP switch boxes in the screw sleeves there.

S+D25	25 screws and rawl plugs 25 mm	Art. No. 30999001	7,50 €/pc.
--------------	--------------------------------	--------------------------	-------------------



Manuals and documents in further languages:
<http://eltako.com/redirect/RC12-230V>

RC12-230V

Triple RC module

Modular device for DIN-EN 60715 TH35 rail mounting.

1 module = 18 mm wide, 58 mm deep.

Used to compensate for inductive interference voltages on control leads. Up to three switchgear devices can be interference-suppressed by connection in parallel with the 230 V control inputs.

RC12-230V	Triple RC module	Art. No. 22000015	42,00 €/pc.
------------------	------------------	--------------------------	--------------------



Manuals and documents in further languages:
<http://eltako.com/redirect/WP50>

WP50

WET.PROTECT e.nautic 50ml.

High-performance protection against humidity, moisture and corrosion. This water blocker completely infiltrates any moisture and humidity. It creates a micro-thin protective film with extremely water repellent effect. The dielectric strength is extremely high with 200 kV/mm. Due to the salt water resistance, it is not only perfect for the use in winter as it protects against the effects of road salt, but also for applications close to the sea. Wireless pushbuttons treated with this spray according to the operating manual even remain fully functional outdoors on the weather side for years.

WP50	WET.PROTECT 50 ml	Art. No. 30000030	28,30 €/pc.
-------------	-------------------	--------------------------	--------------------

ACCESSORIES

WIRELESS FIELD TEST TOOL P10 PROBARE



P10

The wireless field test tool Probare P10 is a portable field tester which shows the signal quality of the received EnOcean 868MHz telegrams. Additionally it helps to determine the best place for EnOcean transmitters, receivers or repeaters, it can also help to look if any signals are sent or not.

2 AA/LR06 batteries are additionally necessary.

Switch on and off by pressing the ON/OFF button for 1.5 seconds.

The signal quality is shown by LEDs.

With the MODE button you can switch between the different functions.

All shows the signal quality of all received EnOcean telegrams.

Filter shows the signal quality of one unique transmitter.

Repeater activates the repeater function (level 1) by this way you can determine the best position for a repeater.

Radio Link Test allows the wireless coverage testing in combination with the adequate receiver by sending telegrams cyclically.

P10	Wireless level meter Probare	Art. No. 30000370	170,10 €/pc.
-----	------------------------------	-------------------	--------------

ACCESSORIES
INFRARED TRANSMITTER IRT3



Manuals and documents in further languages:
<http://eltako.com/redirect/IRT3>

Further information see page 6-4 and 6-5 chapter 6.

IRT3

NEW

Infrared transmitter with 3 m cable and 3.5 mm jack plug.

To be connected to the MiniSafe2 for use in home automation. For controlling devices with an IR interface, e.g. air conditioners, amplifiers, Xbox One, HD-DVR, stereo receivers, TV sets, SAT TV receivers, CD players, DVD players, Blu-Ray players or other components.

IRT3	Infrared transmitter with 3 m cable and 3.5 mm jack plug	Art. No. 30000100	6,00 €/pc.
-------------	--	--------------------------	-------------------



**ALL TECHNICAL SPECIFICATIONS
AT A GLANCE**

Technical data of the wireless actuators, teach-in list, operating distances and contents of Eltako Wireless telegrams

Technical data switching actuators and dimming actuators for the Eltako RS485 bus	T-2
Technical data switching actuators and dimming actuators for installation	T-3
Teach-in list - Wireless sensors that can be taught-in in wireless actuators	T-4
Teach-in settings of lower rotary switch for the most customary devices of Series 61	T-5
Tapping codes for devices of the series 62	T-5
Teach-in settings of upper rotary switch for the most customary devices of Series 14	T-6
Operating distances of the Eltako Wireless	T-7
Contents of Eltako Wireless telegrams	T-9

The Eltako wireless system works with the reliable and worldwide standardized EnOcean wireless technology in 868 MHz.

It transmits ultra short and interference-proof signals with a range of up to 100 meters in halls.

Eltako wireless pushbuttons reduce the electrosmog load since they emit high-frequency waves that are 100 times weaker than conventional light switches. There is also a significant reduction in low-frequency alternating fields since fewer power cables need to be installed in the building.

TECHNICAL DATA – SWITCHING ACTUATORS AND DIMMING ACTUATORS FOR THE ELTAKO RS485 BUS

Type	F4HK14 FHK14 FSB14 FSR14-4x	FUD14 ¹⁾ FUD14/800W ¹⁾⁷⁾ FRGBW14	FSG14/1-10V ^{b)}	F2L14 ^{b)} F4SR14-LED FFR14, FMS14 FMZ14, FSR14-2x ^{b)} FTN14 ^{b)} FSR14M-2x ^{b)}	FSR14SSR
Contacts					
Contact material/contact gap	AgSnO ₂ /0.5 mm	Power MOSFET	AgSnO ₂ /0.5 mm	AgSnO ₂ /0.5 mm	Opto-Triac
Test voltage control connections/contact	-	-	-	2000 V	4000 V
Rated switching capacity each contact	4A/250 V AC	-	600 VA ⁵⁾	16A/250V AC; FMZ14: 10A/250V AC F4SR14: 8A/250 V AC	up to 400 W ⁶⁾
230 V LED lamps ⁹⁾	up to 200 W	Trailing edge up to 400 W Leading edge up to 100 W FUD14/800W: Trailing edge up to 800 W Leading edge up to 200 W	-	up to 400 W FSR14M: up to 600 W I on ≤ 120A/5 ms	up to 400 W ⁶⁾
Dimmable LED lamps 12-24 V DC		FRGBW14: 4 x 4 A			
incandescent lamps and halogen lamp load 230 V ²⁾	1000 W I on ≤ 10A/10 ms	up to 400 W; FUD14/800W: up to 800 W ¹⁾³⁾⁴⁾	-	2000 W F4SR14: 1800 W I on ≤ 70A/10 ms	up to 400 W ⁶⁾
Fluorescent lamp load with KVG* in lead-lag circuit or non compensated	500 VA	-	-	1000 VA	-
Fluorescent lamp load with KVG* shunt-compensated or with EVG*	250 VA, I on ≤ 10A/10 ms	-	600 VA ⁵⁾	500 VA	up to 400 VA ⁶⁾
Compact fluorescent lamps with EVG* and energy saving lamps ESL	up to 200 W ⁹⁾	up to 400 W ⁹⁾¹⁾	-	up to 400 W ⁹⁾	up to 400 W ⁶⁾⁹⁾
Inductive load cos φ = 0,6/230 V AC inrush current ≤ 35 A	650 W ⁸⁾	-	-	650 W ⁸⁾	-
Max. switching current DC1: 12 V/24 V DC	4 A	-	-	8 A (not FTN14 and FZK14)	-
Life at rated load, cos φ = 1 or for incandescent lamps 500 W at 100/h	>10 ⁵	-	>10 ⁵	>10 ⁵	∞
Service life at rated load, cos φ = 0,6 at 100/h	>4x10 ⁴	-	>4x10 ⁴	>4x10 ⁴	∞
Max. operating cycles	10 ³ /h	-	10 ³ /h	10 ³ /h	10 ³ /h
Maximum conductor cross-section (3-fold terminal)	6 mm ² (4 mm ²)	6 mm ² (4 mm ²)	6 mm ² (4 mm ²)	6 mm ² (4 mm ²)	6 mm ²
Two conductors of same cross-section (3-fold terminal)	2.5 mm ² (1.5 mm ²)	2.5 mm ² (1.5 mm ²)	2.5 mm ² (1.5 mm ²)	2.5 mm ² (1.5 mm ²)	2.5 mm ² (1.5 mm ²)
Screw head	slotted/cross- head, pozidriv	slotted/crosshead, pozidriv	slotted/cross- head, pozidriv	slotted/crosshead, pozidriv	slotted/cross- head, pozidriv
Type of enclosure/terminals	IP50/IP20	IP50/IP20	IP50/IP20	IP50/IP20	IP50/IP20
Electronics					
Time on	100%	100%	100%	100%	100%
Max./min. temperature at mounting location	+50°C/-20°C	+50°C/-20°C	+50°C/-20°C	+50°C/-20°C	+50°C/-20°C
Standby loss (active power)	0.1 W	0.3 W	0.9 W	0.05-0.5 W	0.1 W
Local control current at 230V control input	-	-	-	5 mA	-
Max. parallel capacitance (approx. length) of local control lead at 230 V AC	-	-	-	FTN14: 0.3 μF (1000 m)	-

* EVG = electronic ballast units; KVG = conventional ballast units

¹⁾ Bistable relay as relay contact. After installation, wait for short automatic synchronisation before teaching-in the wireless pushbuttons.

¹⁾ If the load exceeds 200 W (FUD14/800W:400W), a ventilation clearance of 1/2 pitch unit to adjacent devices must be maintained via the spacer DS14.

²⁾ Applies to lamps of max. 150 W.

³⁾ Per dimmer or capacity enhancer it is only allowed to use max. 2 inductive (wound) transformers of the same type, **furthermore no-load operation on the secondary part is not permitted. The dimmer might be destroyed.** Therefore do not permit load breaking on the secondary part. Operation in parallel of inductive (wound) and capacitive (electronic) transformers is not permitted!

⁴⁾ When calculating the load a loss of 20% for inductive (wound) transformers and a loss of 5% for capacitive (electronic) transformers must be considered in addition to the lamp load.

⁵⁾ Fluorescent lamps or LV halogen lamps with electronic ballast.

⁶⁾ Applies to one contact and the sum of both contacts.

⁷⁾ Capacity increase for all dimmable lamp types with Capacity Enhancer FLUD14.

⁸⁾ All actuators with 2 contacts: Inductive load cos φ = 0.6 as sum of both contacts 1000 W max.

⁹⁾ Generally applies to 230 V LED lamps and energy saving lamps (ESL). Due to different lamp electronics, switch on/off problems and a restriction in the maximum number of lamps, however, the dimming ranges may be limited depending on the manufacturer; in particular when the connected load is very low (e.g. with 5 W LEDs). The dimmer switch comfort settings EC1, EC2, LC1, LC2 and LC3 optimise the dimming range, however, the maximum power is then only up to 100 W. In these comfort settings, no inductive (wound) transformers may be dimmed.

The second terminating resistor has to be plugged to the last actuator included in the FAM14 respectively FTS14KS scope of supply.

Eltako Wireless is based on the EnOcean wireless standard for 868 MHz, frequency 868.3 MHz, data rate 125 kbps, modulation mode ASK, max. transmit power 7 dBm (<10 mW).

Compliance with: EN 61000-6-3, EN 61000-6-1 and EN 60669

Type	FSUD FUD61NP FUD61NPN	FUD70S FUD71 FUD71L	FKLD61 ^{a)} FLD61 ^{a)} FRGBW71L ^{a)} FWWKW71L ^{a)}	FHK61, FLC61, FMS61, FMZ61, FSHA, FSR61, FSR61LN, FSR70S, FSR71, FSSA, FSSG, FSVA, FTN61	FSG71/1-10V	FHK61SSR FSR61G	FSB61 FSB71 FSR71NP-4x
Contacts							
Contact material/contact gap	Power MOSFET	Power MOSFET	Power MOSFET	AgSnO ₂ /0.5mm ^{b)}	AgSnO ₂ /0.5mm ^{b)}	Opto Triac	AgSnO ₂ /0.5mm ^{b)}
Spacing of control connections/contact	-	-	6 mm	3 mm	-	-	3 mm
Test voltage control connections/contact	-	-	-	2000 V	-	-	2000 V
Rated switching capacity each contact	-	-	-	10A/250 V AC FSR71: 16A/250 V AC	600 VA ⁴⁾	-	4A/250V AC
Dimmable 230 V LED lamps ³⁾	Trailing edge up to 300W Leading edge up to 100W (not FUD61NP)	Trailing edge up to 300W Leading edge up to 100W FUD71L: Trailing edge up to 1200W Leading edge up to 300W	-	up to 400W I on ≤ 120 A / 5 ms	-	up to 400W I on ≤ 120 A / 20 ms	up to 200W I on ≤ 10 A / 10 ms
Dimmable LED lamps 12-36 V DC	-	-	FLD61:4A FKLD61:30W FRGBW71L:4x2A FWWKW71L:2x4A	-	-	-	-
Incandescent lamp and halogen lamp load ¹⁾ 230 V, I on ≤ 70 A/10 ms	up to 300W ²⁾	up to 400W ²⁾ FUD71L: up to 1200W ²⁾	-	2000 W	-	up to 400 W	1000 W
Fluorescent lamp load with KVG* in lead-lag circuit or non compensated	-	-	-	1000 VA	-	-	500 VA
Fluorescent lamp load with KVG* shunt-compensated or with EVG*	-	-	-	500 VA	600 VA ⁴⁾	up to 400 VA	250 VA
Compact fluorescent lamps with EVG* and energy saving lamps	up to 300W ³⁾ (not FUD61NP)	up to 400W ³⁾ FUD71L: up to 1200W ³⁾	-	up to 400W ³⁾	-	up to 400W ³⁾	up to 200W ³⁾
Inductive load cos φ = 0.6/230 V AC inrush current ≤ 35 A	-	-	-	650 W ⁵⁾	-	-	650 W ⁵⁾
Max. switching current DC1: 12 V/24 V DC	-	-	-	8A (not NP, FSHA, FSSA, FSVA, 70, 71)	-	-	-
Service life at rated load, cos φ = 1 or incandescent lamps 500W at 100/h	-	-	-	> 10 ⁵	> 10 ⁵	∞	> 10 ⁵
Service life at rated load, cos φ = 0.6 at 100/h	-	-	-	> 4x10 ⁴	> 4x10 ⁴	-	> 4x10 ⁴
Max. operating cycles	-	-	-	10 ³ /h	10 ³ /h	10 ³ /h	10 ³ /h
Maximum conductor cross-section	4 mm ²	4 mm ²	4 mm ²	4 mm ²	4 mm ²	4 mm ²	4 mm ²
Two conductors of same cross-section	1.5 mm ²	1.5 mm ²	1.5 mm ²	1.5 mm ²	1.5 mm ²	1.5 mm ²	1.5 mm ²
Screw head	slotted/ crosshead	slotted/ crosshead	slotted/ crosshead	slotted/ crosshead	slotted/ crosshead	slotted/ crosshead	slotted/ crosshead
Type of enclosure/terminals	IP30/IP20	IP30/IP20	IP30/IP20	IP30/IP20	IP30/IP20	IP30/IP20	IP30/IP20
Electronics							
Time on	100%	100%	100%	100%	100%	100%	100%
Max./min. temperature at mounting location	+50°C/-20°C	+50°C/-20°C	+50°C/-20°C	+50°C/-20°C	+50°C/-20°C	+50°C/-20°C	+50°C/-20°C
Standby loss (active power)	0.7W	0.6W FUD71: 0.7W	0.2-0.6W	0.3W-0.9W	1W	0.8W	0.8W
Control current universal control voltage 8/12/24/230 V (<5 s)	-	-	2/3/7/4(100)mA	-	-	-	-
Local control current at 230 V control input, only on Series 61	1mA	-	-	3.5 mA; FSR61/8-24 V UC at 24 V DC: 0.2 mA	-	3.5 mA	3.5 mA
Max. parallel capacitance (approx. length) of local control lead at 230 V AC	0.06 μF (200m)	-	0.3 μF (1000m)	3nF (10m)	-	3nF (10m)	3nF (10m)

^{a)} Secondary cable length with a maximum of 2m.

^{b)} Bistable relay as relay contact. After installation, wait for short automatic synchronisation before teaching-in the wireless pushbuttons.

¹⁾ Applies to lamps of max. 150 W.

²⁾ Also max. 2 induction transformers of the same type (L load) and electronic transformers (C load).

³⁾ Generally applies to 230 V LED lamps and energy saving lamps (ESL). Due to different lamp electronics, switch on/off problems and a restriction in the maximum number of lamps, however, the dimming ranges may be limited depending on the manufacturer; in particular when the connected load is very low (e.g. with 5 W LEDs). The dimmer switch comfort settings LC1, LC2, LC3, EC1 and EC2 optimise the dimming range, however, the maximum power is then only up to 100W. In these comfort settings, no inductive (wound) transformers may be dimmed.

⁴⁾ Fluorescent lamps or LV halogen lamps with electronic ballast.

⁵⁾ All actuators with 2 contacts: Inductive load cos φ = 0.6 as sum of both contacts 1000 W max.

* EVG = electronic ballast units; KVG = conventional ballast units.

Eltako Wireless is based on the EnOcean wireless standard for 868 MHz, frequency 868.3 MHz, data rate 125 kbps, modulation mode ASK, max. transmit power 7 dBm (<10 mW).

To comply with DIN VDE 0100-443 and DIN VDE 0100-534, a Type 2 or Type 3 surge protection device (SPD) must be installed.

TECHNICAL DATA SWITCHING ACTUATORS AND DIMMING ACTUATORS FOR INSTALLATION

Type	FD62NP	FD62NPN	FR62NP ^{b)} FL62NP ^{b)} FDH62NP ^{b)}	FR62 ^{b)} FL62 ^{b)}	FJ62NP
Contacts					
Contact material/contact gap	Power MOSFET	Power MOSFET	AgSnO ₂ /0.5mm	AgSnO ₂ /0.5mm	AgSnO ₂ /0.5mm
Spacing of control connections/contact	-	-	3 mm	6 mm	3 mm
Test voltage control connections/contact	-	-	2000V	4000V	2000V
Rated switching capacity each contact	-	-	10A/250V AC	10A/250V AC	4A/250V AC
Dimmable 230V LED lamps ²⁾	Trailing edge up to 200W Leading edge up to 40W	Trailing edge up to 300W Leading edge up to 100W	up to 200W I on ≤ 120 A / 5 ms	up to 200W I on ≤ 120 A / 5 ms	-
Incandescent lamp and halogen lamp load ¹⁾ 230 V, I on ≤ 70 A/10 ms	up to 200W ³⁾	up to 300W ³⁾	2000 W	2000 W	-
Fluorescent lamp load with KVG* in lead-lag circuit or non compensated	-	-	1000 VA	1000 VA	-
Fluorescent lamp load with KVG* shunt-compensated or with EVG*	-	-	500 VA	500 VA	-
Compact fluorescent lamps with EVG* and energy saving lamps	up to 200W ²⁾	up to 300W ²⁾	up to 200W ²⁾	up to 200W ²⁾	-
Inductive load cos φ = 0.6/230 V AC inrush current ≤ 35 A	-	-	650W	650W	650 W
Max. switching current DC1: 12 V/24 V DC	-	-	-	8 A	-
Service life at rated load, cos φ = 1 or incandescent lamps 500 W at 100/h	-	-	> 10 ⁵	> 10 ⁵	> 10 ⁵
Service life at rated load, cos φ = 0.6 at 100/h	-	-	> 4x10 ⁴	> 4x10 ⁴	> 4x10 ⁴
Max. operating cycles	-	-	10 ³ /h	10 ³ /h	10 ³ /h
Type of connection	Plug-in terminals	Plug-in terminals	Plug-in terminals	Plug-in terminals	Plug-in terminals
Minimum conductor cross-section	0.2 mm ²	0.2 mm ²	0.2 mm ²	0.2 mm ²	0.2 mm ²
Maximum conductor cross-section	2.5 mm ²	2.5 mm ²	2.5 mm ²	2.5 mm ²	2.5 mm ²
Stripping of the conductor	8-9 mm	8-9 mm	8-9 mm	8-9 mm	8-9 mm
Type of enclosure/terminals	IP30/IP20	IP30/IP20	IP30/IP20	IP30/IP20	IP30/IP20
Electronics					
Time on	100%	100%	100%	100%	100%
Max./min. temperature at mounting location	+50°C/-20°C	+50°C/-20°C	+50°C/-20°C	+50°C/-20°C	+50°C/-20°C
Standby loss (active power)	0.6 W	0.5 W	0.4 W	0.4 W	0.6 W
Local control current at 230 V control input	3 mA	3 mA	3 mA	3 mA	3 mA
Max. parallel capacitance (approx. length) of local control lead at 230 V AC	30 nF (100 m)	30 nF (100 m)	30 nF (100 m) FL62NP: 10 nF (30 m)	30 nF (100 m)	10 nF (30 m)

^{b)} Bistable relay as relay contact. After installation, wait for short automatic synchronisation before teaching-in the wireless pushbuttons.

¹⁾ Applies to lamps of max. 150 W.

²⁾ Generally applies to 230 V LED lamps and energy saving lamps (ESL). Due to different lamp electronics, switch on/off problems and a restriction in the maximum number of lamps, however, the dimming ranges may be limited depending on the manufacturer; in particular when the connected load is very low (e.g. with 5 W LEDs).

³⁾ No inductive (wound) transformers.

Etako Wireless is based on the EnOcean wireless standard for 868 MHz, frequency 868.3 MHz, data rate 125 kbps, modulation mode ASK, max. transmit power 7 dBm (<10 mW).

To comply with DIN VDE 0100-443 and DIN VDE 0100-534, a Type 2 or Type 3 surge protection device (SPD) must be installed.

Compliance with: EN 61000-6-3, EN 61000-6-1 and EN 60 669

TEACH-IN LIST - WIRELESS SENSORS THAT CAN BE TAUGHT-IN IN WIRELESS ACTUATORS



Sensors	Pushbuttons, handheld transmitters and remote controls B4, F1, F2, F4, F4T65B, FF8, FFD, FFT55, FHS, FKD, FMH, FMT55, FSTAP, FT55, FTTB	Transmitter modules FASM60 FSM14 FSM60B FSM61 FSU... FTS14EM F4USM61B	Card switch, pull switch and smoke alarm FHMB FKF FRW FRWB FZS	Window/door contact FFKB FFTE FPE FTK FTKB FTKE	Window handle sensor and window/door contact FFG7B mTronic	Motion/brightness sensors FABH65S FB... FBH...	Brightness sensors FAH60 FAH60B FAH65S FHD60SB FIH65S	Temperature controller/sensors FFT... FFT60SB FTF65S FTFB FTFSB FTR... FUTH...	Air quality sensor FLGTF
Actuators									
F2L14	X	X		X	X			X	X
F4HK14	X	X		X	X	X ³⁾		X ¹⁾	X ¹⁾
F4SR14-LED	X	X	X	X	X	X	X		
FAE14...	X	X		X	X	X ³⁾		X ¹⁾	X ¹⁾
FDG14	X	X		X		X			
FHK14	X	X		X	X	X ³⁾		X ¹⁾	X ¹⁾
FMS14	X	X	X						
FMZ14	X	X	X	X	X				
FRGBW14	X	X				X	X		
FSB14	X	X		X	X		X		
FSG14/1-10V	X	X		X		X	X		
FSR14...	X	X	X	X	X	X	X		
FTN14	X	X		X	X	X			
FUD14...	X	X		X		X	X		
FAC...	X			X	X	X		X ¹⁾	X ¹⁾
FD62...	X	X				X			
FDG62	X	X				X			
FDG71	X	X		X		X			
FFR61-230V	X	X							
FGM	X	X	X	X		X ³⁾			
FHD62NP	X	X		X	X				
FHK61	X	X		X	X	X ³⁾		X ¹⁾	X ¹⁾
FJ62...	X	X		X	X				
FKLD61	X	X				X	X		
FL62...	X	X	X			X			
FLC61NP-230V	X	X	X			X	X		
FLD61	X	X				X	X		
FMS61NP-230V	X	X							
FMZ61-230V	X	X	X	X					
FR62...	X	X		X	X				
FRGBW71L	X	X				X	X		
FSB61...	X	X		X	X		X		
FSB71...	X	X		X	X		X		
FSG71/1-10V	X	X		X					
FSHA-230V	X	X		X	X	X ³⁾		X ¹⁾	X ¹⁾
FSR61...	X	X	X	X	X	X	X		
FSR71...	X	X	X	X	X	X	X		
FSR70S-230V	X	X	X			X ³⁾	X		
FSSA-230V	X	X		X					
FSUD-230V	X	X							
FSVA-230V	X	X		X					
FTN61NP-230V	X	X		X	X	X			
FUA12-230V	X	X	X	X	X	X	X		
FUD61...	X	X				X	X		
FUD71	X	X		X		X	X		
FUD70S-230V	X	X							
FUTH...				X	X				
FWWKW71L	X	X				X	X		

¹⁾ Only evaluation of temperature ²⁾ Only motion detection

TEACH-IN SETTINGS OF LOWER ROTARY SWITCH FOR THE MOST CUSTOMARY DEVICES OF SERIES 61* TAPPING CODES FOR DEVICES OF THE SERIES 62

Type	FMS61 from week 08/13	FMZ61 from week 18/11	FSB61 from week 39/12	FSR61 from week 41/12	FSR61 from week 11/14	FTN61 from week 25/11	FUD61NP from week 38/12	FUD61NPN from week 40/12
Teaching-in function	Phase-out-model							
Universal pushbutton / toggle / switch over (On/Off)	UT1 = channel 1 UT2 = channel 2	(2)	2	60	80	Approx. middle	2	LC2
Universal pushbutton NC contact				120	120			
Direction pushbutton	RT1 = channel 1 RT2 = channel 2	1h	min			40	max	EC1
On / central ON resp. UP			3	∞	∞	20	3	LC3
Off / central OFF resp. DOWN	(1)		1	2	2	1	1	LC1
FTK as NC contact	0,5s		2	2	2	20		
FTK as NO contact	(3)				∞	∞	1	
FBH as motion detector					∞ (Slave)	20	max	EC1
FBH as motion detector with brightness sensor					2..120	1..20	min...3	AUTO...EC2
FAH as twilight sensor			min..max	2..120	2..120			
FSU or pushbutton as wake-up light	EC2							
Controller LZ light scene	RT1 = controller RT2 = controller	max		6 = LZ	80 = controller 6 = LZ	min		AUTO

Additional information:

Clear all addresses:

Turn position CLR and the other rotary switches 3 times from centre to right. Centre-right-centre-right-centre-right.

Activate or deactivate feedback:

Turn position CLR and the other rotary switches 3 times from centre to left. Centre-left-centre-left-centre-left.

Activate or deactivate Repeater Level 1:

Switch off power, depress pushbutton connected to the pushbutton input and switch power back on.

Tapping codes for devices of the series 62

Function/service	Tap function	FL62	FR62	FJ62	FD62	FSLA
Universal pushbutton	3x	x	3x NO contact 4x NC contact	x	x	x
Direction pushbutton	4x	x	-	x	x	x
Central on/up	5x	x	-	x	x	x
Central off/down	6x	x	-	x	x	x
Window contacts	3x	-	NO contact	-	-	-
Window contacts	4x	-	NC contact	x	-	-
Motion detector	1x	x	-	-	x	x
GFVS	1x	x	x	x	x	x
Phase angle	5x briefly 1x long	-	-	-	x	-
Auto mode	6x briefly 1x long	-	-	-	x	-
Lock	3x briefly 1x long	x	x	x	x	x
Unlock	4x briefly 1x long	x	x	x	x	x
Switch RM on/off	7x briefly 1x long	x	x	x	x	x
Clear content	8x briefly 1x long	x	x	x	x	x
Dimming speed slow	9x	-	-	-	x	-
Dimming speed middle	10x	-	-	-	x	-
Dimming speed fast	11x	-	-	-	x	-

TEACH-IN SETTINGS OF UPPER ROTARY SWITCH FOR THE MOST CUSTOMARY DEVICES OF SERIES 14



Type	FAE14 FHK14	FMS14	FSB14	FSR14	FTN14	FUD14
Teaching-in function						
Universal pushbutton / toggle / switch over (On/Off)		3 channel 1+2 7 channel 1 8 channel 2	20 channel 1 40 channel 2	5 switch 10 relay	3	EC2
Direction pushbutton		5 channel 1+2 9 channel 1 10 channel 2	10 channel 1 30 channel 2	0		LC2
On / Central On		4	180 channel 1 200 channel 2	45	4	LC1
Off / Central Off		2		90	2	EC1
Sequential light scene pushbutton						LC3
4-way direct light scene pushbutton			180 channel 1 200 channel 2	30		LC4
Single light scene pushbutton						LC5
Staircase light switch					3	LC6
Wireless Visualisation and Control Software GFVS	4,5	9 channel 1 10 channel 2	180 channel 1 200 channel 2	0	2 off 4 on	PCT
FTK window/door contact			20 channel 1 40 channel 2	0	LC2 as NO contact LC3 as NC contact	LC2 as NO contact LC3 as NC contact
FAH brightness sensor			150 both channels	0-120		LC5 as NO contact LC6 as NC contact
FSU or pushbutton as wake-up light						AUTO
FBH as motion detector with brightness sensor	4,5			0-120	1...20	AUTO
Central control without priority			60 both channels	45 on 90 off		
Central control with priority, first signal starts priority, second signal stops it			90 both channels			
Central control with priority as long as signal is applied			120 both channels	15 on 20 off		
FTR temperature controller	4,5					

OPERATING DISTANCES BETWEEN SENSORS AND ACTUATORS.

Compared with hard-wired systems, EnOcean wireless systems are highly flexible and simple to install. The following instructions simplify installation. You will find detailed instructions on wireless network planning in the 12-page booklet "EnOcean Wireless Systems – Range planning Guide" that you can download from www.enocean.com.

1. Wireless signal range

Wireless signals are electromagnetic waves. The field strength at the receiver decreases the further the distance away from the transmitter. The wireless range is therefore limited.

Obstacles standing in the radio field also shorten range compared with line-of-sight links:

OBSTACLE	REDUCED RANGE
Wood, plaster, glass uncoated, with no metal	0 - 10 %
Brick, particle board	5 - 35 %
Concrete with iron reinforcement bars	10 - 90 %
Metal, aluminium cladding	see 2.

The geometric shape of a room determines the radio range since propagation is not in the form of a beam but requires a certain volume of space (the radio beam from the transmitter and receiver ellipsoidal at their points of focus). Narrow corridors with solid walls are bad for propagation.

External antennas typically have better radio characteristics than flush-mounted receivers installed in walls. The type of fitted for the antennas and the spacing from ceilings, floors and walls all play a role.

People and obstacles in a room may reduce range.

It is therefore essential to integrate some reserve when performing range planning to ensure the reliable functioning of the wireless system even in poor conditions.

A sturdy, reliable installation in a building is achieved by integrating sufficient range reserves.

Recommendations from everyday practice:

RANGE	CONDITIONS
> 30 m	Under excellent conditions: Large free room, optimum antenna design and good antenna position.
> 20 m (planning safety)	If there are furniture and persons in the room, through up to 5 dry plasterboard walls or 2 brick/aerated concrete walls: For transmitters and receivers with good antenna design and good antenna position.
> 10 m (planning safety)	If there are furniture and persons in the room, through up to 5 plasterboard drywalls or 2 brick/aerated concrete walls: For receivers fitted in wall or in ceiling. Or small receiver with internal antenna. Or together with switch/wire antenna on/near metal. Or a narrow corridor.

RANGE	CONDITIONS
Dependent on reinforcement and antenna design	Vertical through 1-2 ceilings

2. Partitioning

So-called radio shadows form behind metal surfaces, e.g. behind metal partition walls and metal ceilings, behind metal foils of heat insulation and solid reinforcement in concrete walls. Single thin metal strips have very little influence, for example the profile sections in a plasterboard drywall.

It has been observed that radio communications also works with metal room dividers. This occurs by reflections: metal and concrete walls reflect radio waves and they travel to neighbouring corridors or rooms through openings, e.g. in a wooden door or a glass partition. The range may be strongly reduced depending on the location. An additional repeater at a suitable location can easily offer alternative radio paths.

Important conditions that reduce radio range:

- Metal partition walls or hollow walls filled with insulation wool backed by metal foil
- Suspended ceilings with panels made of metal or carbon fibre
- Steel furniture or glass with metal coating
- Fitting the pushbutton on a metal wall (typical range loss: 30%)
- Use of metal pushbutton frames (typical range loss: 30%)

Firewalls, staircases and building services areas should be regarded as partitions.

A partition can be avoided by repositioning the transmitter/receiver antenna out of the radio shadow or by using a repeater.

OPERATING DISTANCES BETWEEN SENSORS AND ACTUATORS.

3. Penetration angle

The angle at which the transmitted signal impinges on the wall plays a special role. Signals should penetrate masonry as vertically as possible. Wall niches must be avoided.

4. Antenna installation

The receive antenna or a **receiver with an integrated antenna** should not be installed on the same side of the wall as the transmitter. It is better to install the antenna on adjacent or opposite walls. The antennas should be spaced from the room corner at a distance of >10 cm as far as possible.

The ideal installation location for the receive antenna is a central position in the room.

A **"magnet foot antenna"** (e.g. Eltako FA200 or FA250) must adhere on a metallic surface that is as large as possible in order to create a sufficient opposite pole. For example, the simplest installation can be on a ventilation pipe.

5. Spacings between receiver and other interference sources

The spacing between the receiver and other transmitters (e.g. GSM/DECT/Wireless LAN) and high-frequency interference sources (computer, audio and video systems) should be >50 cm.

Eltako transmitters, on the other hand, can be installed without any problem next to other transmitters and interference sources.

6. Use of repeaters

In case of problems with reception quality, it may be helpful to use a wireless repeater. The Eltako Repeater FRP61 (see page 3-31) requires no configuration, only a mains connection. It receives the wireless signal and passes it on. This almost doubles the range. Eltako repeaters are switchable to 2-level function and allow more than two repeaters to be cascaded.

7. Field strength measuring instrument

The wireless level meter Probare P10 (see chapter Z) helps to find the best position for transmitter and receiver.

Moreover, it can be used to test link interferences in installed devices and even identify an interfering transmitter.

8. Installation in residential buildings

Here there is no real necessity to overcome large radio links.

If necessary, a central wireless repeater can be installed to amplify the signal.

9. Installation in industrial buildings

To cover large premises, a wireless gateway is typically used as an automation bus (TCP/IP, EIB/KNX, LON, etc.). Planning with a range radius of 10-12 m offers sufficient security, even if there are the usual changes to the environmental conditions later.

CONTENTS OF ELTAKO WIRELESS TELEGRAMS

COMMUNICATION WITHIN ELTAKO WIRELESS BUILDING

All Eltako wireless sensors and Eltako wireless actuators communicate within the Eltako wireless network by means of wireless telegrams that are formatted using the world-wide standard of EnOcean Alliance. These are the EEPs as described below; some of them are partly modified to a certain extent. The feedback from the bidirectional actuators to confirm the switch position correspond to those of the PTM215 wireless modules but without the telegram sent when the button is released.

SENSOR TELEGRAMS

F1T65, F1FT65, F1T55E, F1T80, F2T55E, F4D, FMH1W, FNS55B, FNS55EB, FNS65EB, FPE-1 (EEP F6-01-01)

ORG = 0x05
Data_byte3 = push = 0x10, release = 0x00

F2T65, F2T65B, F2FT65, F2FT65B, F2ZT65, F2ZT65B, F2T55E, F2T55EB, F2ZT55E, F4CT55, F4CT55E, FZT55, FHS2, FMH2, FMH2S (EEP F6-02-01)

ORG = 0x05
Data_byte3 = push up = 0x70, push bottom = 0x50, release = 0x00

F3Z14D (EEP A5-12-01, 02, 03)

Electricity EEP A5-12-01
ORG = 0x07
Data_byte3 to Data_byte1 form a 24-bit binary coded number
Data_byte3 = Data Byte 3 (MSB) 0...16777215
Data_byte2 = Data Byte 2 0...16777215
Data_byte1 = Data Byte 1 (LSB) 0...16777215
Data_byte0 = DBO_Bit4 = -
DBO_Bit3 = LRN Button (0 = teach-in telegram, 1 = data telegram)
DBO_Bit2 = data content switchover:
1 = momentary power in watts, 0 = meter status in 0.1 KW/h
DBO_Bit1 = 0 (fix)
DBO_Bit0 = 1 (fix)
Possible values in data telegram:
DBO = 0x09 -> meter status normal rate in 0,1 KW/h
DBO = 0x0C -> momentary power in W, normal rate active
DBO = 0x1C -> momentary power in W, off-peak rate active
Teach-in telegram: 0x48080D80
ID = Base-ID of FAM14 + device addresses of F3Z14D
Gas EEP A5-12-02 Teach-in telegram: 0x48100D80
Water EEP A5-12-03 Teach-in telegram: 0x48180D80

F4T65, F4T65B, F4FT65, F4FT65B, F4PT, FT4F, F4T55E, F4T55EB, F4PT55, FHS4, FMH4, FMH4S, FF8, FMH8 (EEP F6-02-01)

ORG = 0x05
Data_byte3 = push top right = 0x70, push bottom right = 0x50,
push top left = 0x30, push bottom left = 0x10,
release = 0x00

F4T55B, FT55 (EEP F6-02-01)

Data_byte3 = 0x70/0x50 (with rocker)
= 0x70/0x50/0x30/0x10 (with double rocker)
release = 0x00

F4USM61B

EEP A5-07-01
Data_byte3 = -
Data_byte2 = -
Data_byte1 = E2, E4 = 0xC8 = semi-automatic motion detection
E1, E3 = 0xFF = fully automatic motion detection
Data_byte0 = 0x08
Teach-in telegram: 0x1C080D80

EEP A5-08-01
ORG = 0x07
Data_byte3 = -
Data_byte2 = -
Data_byte1 = -
Data_byte0 = 0x0D = motion
0x0F = no motion
Teach-in telegram: 0x20080D85

EEP A5-38-08
Data_byte3 = 0x01
Data_byte0 = E2, E4 = 0x08 = OFF
E1, E3 = 0x09 = ON
Teach-in telegram: 0xE0400D80

EEP D5-00-01
ORG = 0x06
Data_byte3 = contact closed -> 0x09
contact open -> 0x08

EEP F6-02-01
ORG = 0x05
Data_byte3 = E1 = 0x70, E2 = 0x50, E3 = 0x30, E4 = 0x10, release = 0x00

F6T65B, F6T55B, F6T55EB (EEP F6-02-01)

ORG = 0x05
Data_byte3 = 0x70/0x50/0x30/0x10
Data_byte3 = 0x70/0x50
release = 0x00

Presence telegram according to EEP A5-07-01
Data_byte3 = operating voltage 0..5V (0..250)
Data_byte2 = -
Data_byte1 = 0xFF
Data_byte0 = 0x08
Teach-in telegram: 0x1C080D80

FABH130

ORG = 0x05
Data_byte3 = 0x70 = motion
0x00 = no motion

SENSOR TELEGRAMS

FABH65S, FBH65, FBH65S, FBH65TF (EEP A5-08-01 EXCEPTIONS BY ELTAKO)

Expanded brightness range, no Occupancy Button in DB0_Bit0)
 ORG = 0x07
 Data_byte3 = operating voltage 0..5,1V (0..255)
 Data_byte2 = brightness 0..510 lux (0..255)
 Data_byte1 = -
 Data_byte0 = 0x0D = motion
 0x0F = no motion
 Teach-in telegram: 0x20080D85

only FBH65TF additionally EEP A5-04-02
 Data_byte2 = rel. air humidity 0..100% (0..250)
 Data_byte1 = temperature -20..+60°C (0..250)
 Teach-in telegram: 0x10100D87
 ORG = 0x05
 Data_byte3 = 0n = 0x70, Off = 0x50

FAH65S, FIH65S (EEP A5-06-01 EXCEPTIONS BY ELTAKO)

ORG = 0x07
 Data_byte3 = brightness 0..100 lux (0..100)
 (only valid if DB2 = 0x00)
 Data_byte2 = brightness 300..30.000 lux (0..255)
 Data_byte1 = -
 Data_byte0 = 0x0F
 Teach-in telegram: 0x18080D87

FASM60, FSM14, FSM61

ORG = 0x05
 Data_byte3 = 0x70/0x50
 only FSM14 additionally 0x30/0x10

FB65B, FB55B, FB55EB, FBH65SB, FBH55ESB, FBH55SB, FBHF65SB (EEP A5-07-01 ODER A5-08-01)

EEP A5-07-01
 Data_byte3 = -
 Data_byte2 = -
 Data_byte1 = 0xC8 = semi-automatic motion detection
 0xFF = fully automatic motion detection
 Data_byte0 = 0x08
 Teach-in telegram: 0x1C080D80

Only FBH65SB, FBH55SB, FBHF65SB
 FBH mode data telegram acc. to EEP A5-08-01
 ORG = 0x07
 Data_byte3 = operating voltage 0..5,1V (0..255)
 Data_byte2 = brightness 0..510 lux (0..255)
 Data_byte1 = -
 Data_byte0 = 0x0D = motion
 0x0F = no motion
 Teach-in telegram: 0x20080D85

FC02TF65, FC02TS (EEP A5-09-04)

ORG = 0x07
 Data_byte3 = humidity 0..100% (0..200)
 Data_byte2 = CO₂ value 0..2550ppm (0..255)
 Data_byte1 = temperature 0..51°C (0..255)
 Teach-in telegram: 0x24200D80

FDT65B, FDT55B, FDT55EB, FDTF65B (EEP A5-38-08)

ORG = 0x07
 Data_byte3 = 0x02
 Data_byte2 = dimming value in % (0..100)
 Data_byte1 = 0x01
 Data_byte0_Bit0: 1 = On, 0 = Off
 Teach-in telegram: 0xE0400D80

FFD

ORG = 0x05
 Data_byte3 = 0x70/0x50/0x30/0x10
 Dimming value acc. to EEP A5-38-08
 ORG = 0x07
 Data_byte3 = 0x02
 Data_byte2 = dimming value in % (0..100)
 Data_byte1 = 0x01
 Data_byte0_Bit0: 1 = On, 0 = Off
 Teach-in telegram: 0xE0400D80

FFG7B (EEP A5-14-09 OR EEP F6-10-00)

ORG = 0x07
 Data_byte3 = operating voltage: 0..5 V (0..250)
 Data_byte0 = 0x08 = window closed
 0x0E = window open
 0x0A = window tilted
 Teach-in telegram: 0x50480D80

EEP F6-10-00
 ORG = 0x05
 Data_byte3 = 0xF0 = window closed
 0xE0 = window open
 0xD0 = window tilted

FFGB-hg (EEP A5-14-0A, A5-14-09, A5-14-01, A5-14-03, A5-14-07, A5-14-08 or F6-10-00)

FFT65B, FFTF65B, FFT55B, FFT55EB, FTFB, FTFSB, FFT60SB (EEP A5-04-02 OR A5-04-03)

EEP A5-04-02
 Data_byte2 = rel. air humidity 0..100% (0..250)
 Data_byte1 = temperature -20..+60°C (0..250)
 Teach-in telegram: 0x10100D87

EEP A5-04-03
 Data_byte3 = rel. air humidity 0..100% (0..255)
 Data_byte2 and 1 = temperature -20..+60°C (0..1023)
 Teach-in telegram: 0x10180D80

FHD60SB (EEP A5-06-01 UND A5-38-08)

FAH-Modus: Data telegram acc. to EEP A5-06-01
 Data_byte3 = brightness 0..100 lux (0..100)
 (only valid if DB2 = 0x00)
 Data_byte2 = brightness 300..30.000 lux (0..255)
 Data_byte1 = -
 Data_byte0 = 0x09
 Teach-in telegram: 0x18080D80

TF-Modus: data telegram acc. to EEP A5-38-08
 Data_byte3 = 0x01
 Data_byte0 = 0x08 = OFF
 0x09 = ON
 0x28 = unlock
 Teach-in telegram: 0xE0400D80

SENSOR TELEGRAMS

<p>FHD65SB (EEP A5-06-02 EXCEPTIONS BY ELTAKO)</p> <p>ORG = 0x07 Data_byte3 = operating voltage 0..5,1V (0..255) Data_byte2 = brightness 0..1020 lux (0..255) Data_byte1 = - Data_byte0 = 0x0F Teach-in telegram: 0x18100D87</p>
<p>FHMB, FRWB (EEP A5-30-03)</p> <p>ORG = 0x07 Data_byte3 = 0x00 Data_byte2 = temperature 0..40°C (255..0) Data_byte1 = 0x0F = alarm, 0x1F = no alarm Data-Byte0 = 0x08 Teach-in telegram: 0xC0182D80</p>
<p>FKF65</p> <p>ORG = 0x05 Data_byte3 = 0x10/status (hex) KCG = 0x20 KCS = 0x30</p>
<p>FKS-H (EEP A5-20-04)</p> <p>Data_byte3 = Valve position 0-100% (0..100) Data_byte2 = (if data_byte0 = 08) flow temperature 20..80°C (0..255) Data_byte2 = (if data_byte0 = 0A) setpoint temperature 10..30°C (0..255) Data_byte2 = (if data_byte0 = 09) Error code 0x12 = battery empty Data_byte1 = actual temperature 10..30°C (0..255) Teach-in telegram: 0x80204580</p>
<p>FLGTF65, FLGTF55, FLGTF55E (EEP A5-09-0C AND A5-04-02) FLT58 (EEP A5-09-05 AND A5-04-02)</p> <p>TVOC data telegram acc. to EEP A5-09-0C Data_byte3 + Data_byte2 = 0..65535 ppb (0..255) Data_byte1 = 0x00 Data_byte0 = 0x0A Teach-in telegram: 0x24600D80</p> <p>VOC data telegram acc. to EEP A5-09-05 Data_byte3 + Data_byte2 = 0..500 Data_byte1 = 0x1B Data_byte0 = 0x0A Lerntelegramm: 0x24280D80</p> <p>Temperature humidity data telegram acc. to EEP A5-04-02 Data_byte3 = - Data_byte2 = rel. air humidity 0..100% (0..250) Data_byte1 = temperature -20..+60°C (0..250) Data_byte0 = 0x0F Teach-in telegram: 0x10100D87</p>
<p>FMMS44SB, FMS55SB, FMS55EB, FMS65EB (EEP D2-14-41, D2-14-40, A5-04-01, A5-04-03, A5-02-05, A5-06-02, A5-06-03, A5-14-05, ONLY FMMS44SB ADDITIONALLY D2-00-01)</p>
<p>FNS55B, FNS55EB, FNS65EB (EEP F6-01-01)</p> <p>ORG = 0x05 Data_byte3 = Hand in the detection area = 0x10, Hand away = 0x00</p>
<p>FRW</p> <p>ORG = 0x05 Data_byte3 = 0x10 = alarm 0x00 = alarm-end 0x30 = battery voltage < 7.2V</p>

<p>FSM60B</p> <p>ORG = 0x05 Data_byte3 = 0x70 / 0x50 / 0x10 / 0x00 EEP A5-30-01 ORG = 0x07 Data_byte1 = 0x00 / 0xFF EEP A5-30-03 ORG = 0x07 Data_byte1 = 0x0F / 0x1F</p>
<p>FSU65D, FSU55D, FSU55ED</p> <p>ORG = 0x05 Data_byte3 = 0x70 = switch on, 0x50 = switch off Clock telegram acc. to EEP A5-13-04 Teach-in telegram: 0x4C200D80 Tap-radio telegram acc. to EEP A5-38-08 Teach-in telegram: 0xE0400D80</p>
<p>FSDG14, FSS12-12V DC, FWZ14, FWZ12, DSZ14DRS, DSZ14WDRS (EEP A5-12-01)</p> <p>ORG = 0x07 Data_byte3 to Data_byte1 form a 24-bit binary coded number Data_byte3 = Data Byte 3 (MSB) 0...16777215 Data_byte2 = Data Byte 2 0...16777215 Data_byte1 = Data Byte 1 (LSB) 0...16777215 Data_byte0 = DB0.Bit4 = tariff changeover (0 = Normal rate, 1= Off-peak rate) DB0.Bit3 = LRN Button (0 = teach-in telegram, 1 = data telegram) DB0.Bit2 = data content switchover: 1 = momentary power in watts, 0 = meter status in 0.1 KW/h DB0.Bit1 = 0 (fix) DB0.Bit0 = 1 (fix) Possible values in data telegram: DB0 = 0x09 -> meter status normal rate in 0.1 KW/h DB0 = 0x19 -> meter status off-peak rate in 0.1 KW/h DB0 = 0x0C -> momentary power in W, normal rate active DB0 = 0x1C -> momentary power in W, off-peak rate active Teach-in telegram: 0x48080D80 (is sent once at every power-up) ID = base-ID des FAM14 + device address of DSZ14(W)DRS In addition, the meter serial number printed on the meter is transmitted every 10 minutes. The data is divided into 2 consecutive telegrams. 1. part: DB0 = 0x8F -> meter serial number = S-AABBCC (A,B,C = 0..9) DB1 = 0x00 -> the first 2 digits of the serial number in DB3 DB2 = 0x00 DB3 = AA 2. part: DB0 = 0x8F -> meter serial number = S-AABBCC (A,B,C = 0..9) DB1 = 0x01 -> the last 4 digits of the serial number in DB2 and DB3 DB2 = BB DB3 = CC</p>
<p>FSR61VA, FSVA-230V (EEP A5-12-01)</p> <p>ORG = 0x07 Data_byte3 to Data_byte1 form a 24-bit binary coded number Data_byte3 = Data Byte 3 (MSB) 0...16777215 Data_byte2 = Data Byte 2 0...16777215 Data_byte1 = Data Byte 1 (LSB) 0...16777215 Data_byte0 = DB0.Bit4 = 0 (fix) DB0.Bit3 = LRN Button (0 = teach-in telegram, 1 = data telegram) DB0.Bit2 = switchover data content: 1 = momentary power in watts, DB0.Bit1 = 0 (fixed) DB0.Bit0 = 1 (fixed) Possible values in data telegram: DB0 = 0x0C -> momentary power in W, normal rate active Teach-in telegram: 0x48080D80 (is sent once on every power-up)</p>

SENSOR TELEGRAMS

<p>FSTAP, FSMTB</p> <p>ORG = 0x05 Data_byte3 = 0x70 = key right 0x50 = key left 0x00 = key center</p>	<p>FTR78S (EEP A5-10-03)</p> <p>ORG = 0x07 Data_byte3 = - Data_byte2 = setpoint temperature 8..30°C (0..255) Data_byte1 = actual temperature 0..40°C (255..0) Data_byte0 = - Teach-in telegram: 0x40182D80</p>
<p>FS55, FS55E, FS65E (EEP F6-02-01)</p> <p>ORG = 0x05 Data_byte3 = push top = 0x76 push bottom = 0x56</p>	<p>FTR86B (EEP A5-10-06)</p> <p>ORG = 0x07 Data_byte2 = setpoint temperature 0..40°C (0..255) Settable range: 12..28°C Data_byte1 = actual temperature 0..40°C (255..0) Data_byte0 = 0x0F Teach-in telegram: 0x40300D87</p>
<p>FTF65S (EEP A5-02-05)</p> <p>ORG = 0x07 Data_byte3 = - Data_byte2 = - Data_byte1 = actual temperature 0..40°C (255..0) Data_byte0 = 0x0F Teach-in telegram: 0x08280D87</p>	<p>FTS14EM (ONLY TELEGRAMS FOR THE ELTAKO-RS485-BUS)</p> <p>Depending on the set ID range (addition of lower rotary switch + upper rotary switch + 1000) the following basic ID's arise. Example for group 1: 1 (bottom rotary switch) +0 (top rotary switch) +1000 = basis- ID = 1001 Example for group 1: 1 (bottom rotary switch) +90 (top rotary switch) +1000 = basis- ID = 1091 Example for group 5: 401 (bottom rotary switch) +30 (top rotary switch) +1000 = basis- ID = 1431</p> <p>ORG = 0x05</p> <p>Setting UT Data_byte3 = control of +E1 -> 0x70 (basis-ID +0) control of +E2 -> 0x50 (basis-ID +1) control of +E3 -> 0x30 (basis-ID +2) control of +E4 -> 0x10 (basis-ID +3) control of +E5 -> 0x70 (basis-ID +4) control of +E6 -> 0x50 (basis-ID +5) control of +E7 -> 0x30 (basis-ID +6) control of +E8 -> 0x10 (basis-ID +7) control of +E9 -> 0x70 (basis-ID +8) control of +E10 -> 0x50 (basis-ID +9)</p> <p>Automatically pairs are formed with straight ID. when set to RT: +E1/+E2, +E3/+E4, +E5/+E6, +E7/+E8, +E9/+E10 If the control of a control input will be finished, a telegram with the respective ID and Data_byte3 = 0x00 will be created. Data_byte2 = not used (0x00) Data_byte1 = not used (0x00) Data_byte0 = not used (0x00) The control inputs can either be activated for buttons (delivery status), window-door contacts or motion detectors. All control inputs can be inverted.</p>
<p>FTK, FTKB, FFKB, FTKB-gr (EEP D5-00-01)</p> <p>ORG = 0x06 Data_byte3 = contact closed -> 0x09 contact open -> 0x08 Data_byte2 = - Data_byte1 = - Data_byte0 = - Teach-in telegram: 0x00000000</p> <p>only FTKB-rw and FFKB additionally ORG = 0x07 Data_byte2 = battery voltage 0..5V (0..255) Data_byte3 = battery voltage 0..5V (0..255)</p>	<p>FTTB (EEP A5-07-01)</p> <p>ORG = 0x07 Data_byte3 = operating voltage 0..5V (0..255) Data_byte2 = - Data_byte1 = 0xF0 Data_byte0 = 0x0F Presence telegram: 0x1C080D80 Pushbutton telegram: ORG = 0x05 Data_byte3 = 0x70</p>
<p>FTKE, FFTE (EEP F6-10-00)</p> <p>ORG = 0x05 Data_byte3 = 0xF0 = window closed 0xE0 = window open</p>	
<p>FTR65DSB, FTR55DSB, FTR55EHB, FTR55ESB, FTR65HB, FTRF65HB, FTR55HB, FTR65SB, FTRF65SB, FTR55SB</p> <p>Operating mode TF61: EEP A5-38-08 Teach-in telegram: 0xE0400D80 Data telegram: 0xFF = 0x01000008 ON = 0x01000009 Hysteresis: 1°</p> <p>Operating mode FHK: EEP A5-10-06 Teach-in telegram: 0x40300D87 Data_byte2 = Setpoint temperature 0..40°C (0..255) Settable range: 12..28°C Frost symbol = 8°C Data_byte1 = actual temperature 0..40°C (255..0) Data_byte0 = 0x0F</p>	
<p>FTR65HS, FTA65D, FTA65D, FTA65D (EEP A5-10-06 PLUS DATA_BYTE3)</p> <p>ORG = 0x07 Data_byte3 = night reduction 0-5°K in 1° steps 0x00 = 0°K, 0x06 = 1°K, 0x0C = 2°K, 0x13 = 3°K, 0x19 = 4°K, 0x1F = 5°K Data_byte2 = Setpoint temperature 0..40°C (0..255) Settable range: 12..28°C Data_byte1 = actual temperature 0..40°C (255..0) Data_byte0 = 0x0F Teach-in telegram: 0x40300D87</p>	

SENSOR TELEGRAMS

FUTH65D, FUTH55D, FUTH55ED (EEP A5-10-06 AND A5-10-12)

EEP A5-10-06

Data_byte3 = night reduction 0..5°K in 1° steps
 Data_byte2 = setpoint temperature 0..40°C (0..255)
 Settable range: 8..40°C
 Data_byte1 = actual temperature 0..40°C (255..0)
 Data_byte0 = 0x0F
 Teach-in telegram: 0x40300D87

EEP A5-10-12

Data_byte3 = setpoint air humidity 0..100%
 Settable range: 10..90%
 Data_byte2 = rel. air humidity 0..100% (0..250)
 Data_byte1 = temperature 0..40°C (0..250)
 Data_byte0 = 0x08
 Teach-in telegram: 0x40900D80

FWS61 (EEP A5-13-01 AND 02)

The FWS61 has two telegrams to one data set, which are sent successively. In the telegrams last Byte (UU or YY) it can be identified, which telegram part is involved.

Telegram part 1: 0xRRSSTUUU

- RR is the twilight sensor which supplies data from 0..1000Lux (0..255)
 e.g.: 0x7A = 122; $122 * 1000 / 255 = 478 \text{ lux}$
- SS is the temperature which lies between -40°C..+80°C (0..255)
 e.g.: 0x2C = 44; $44 * 120 / 255 = 20,7$ a lower 40 after that $-40 + 20,7 = -19,3^\circ\text{C}$
 e.g.: 0x6F = 111; $111 * 120 / 255 = 52,2$ a not lower then 40 after that $52,2 - 40 = 12,2^\circ\text{C}$
- TT is the wind speed which lies between 0..70 m/s (0..255)
 e.g.: 0x55 = 85; $85 * 70 / 255 = 23 \text{ m/s}$
- UU is either 0x1A with "rain" or 0x18 with "no rain".

Telegram part 2: 0xVWWWXXYY

- VV is the solar value of the west sensor 0..150kLux (0..255)
 e.g.: 0x44 = 68; $68 * 150 / 255 = 40 \text{ klux}$
- WW is the solar value of the south sensor 0..150kLux (0..255)
- XX is the value of the east sensor 0..150kLux (0..255)
- YY is always 0x28

Teach-in telegram: 0x4C080D80

FWS81 (EEP F6-05-01)

ORG = 0x05
 Data_byte3 = 0x11 Status 0x30 = water
 0x11 Status 0x20 = no water

FZS65

ORG = 0x05
 Data_byte3 = 0x30 = pull, 0x00 = release

eTronic (EEP A5-14-01)

ORG = 0x07
 Data_byte3 = voltage 0..5V (0..250)
 Data_byte0 = 0x90000008 = window closed
 0x90000009 = window open
 Teach-in telegram: 0x50081680

mTronic (EEP A5-14-0A)

ORG = 0x07
 Data_byte3 = operating voltage 0..5V (0..250)
 Data_byte0 = 0x08 = window closed
 0x0E = window open
 0x0A = window tilted
 Data_byte0.0: 0 = no alarm, 1 = alarm
 Teach-in telegram: 0x50501680

ACTIVATION TELEGRAMS FROM CONTROLLERS

FSR61, FSR61NP, FSR61G, FSR61LN, FLC61NP

Direct switching command, FUNC=38, Command 1, (like EEP A5-38-08).

There is the possibility to block the switching state with absolut priority so that it cannot be changed by other taught-in pushbuttons.

ORG = 0x07
 Data_byte3 = 0x01
 Data_byte2 = no used
 Data_byte1 = no used
 Data_byte0 = DBO_Bit3 = LRN Button
 (0 = teach-in telegram, 1 = data telegram)
 DBO_Bit2 = 1: block switching state,
 0: do not block switching state
 DBO_Bit0 = 1: switching output ON,
 0: switching output OFF

Teach-in telegram DB3..DB0 must look like this: 0xE0, 0x40, 0x0D, 0x80

Data telegrams have to look like date:

0x01, 0x00, 0x00, 0x09 (switching output ON, not blocked)
 0x01, 0x00, 0x00, 0x08 (switching output OFF, not blocked)
 0x01, 0x00, 0x00, 0x0D (switching output ON, blocked)
 0x01, 0x00, 0x00, 0x0C (switching output OFF, blocked)

FSB14, FSB61, FSB71

Direct drive command with specification of runtime in s. FUNC=3F, Typ=7F (universal). Separately for each channel.

ORG = 0x07
 Data_byte3 = runtime in 100ms MSB
 Data_byte2 = runtime in 100ms LSB, or runtime in seconds 1-255 dec, the runtime setting on the device is ignored.
 Data_byte1 = command:
 0x00 = Stop
 0x01 = Up
 0x02 = Down
 Data_byte0 = DBO_Bit3 = LRN Button
 (0 = teach-in telegram, 1 = data telegram)
 DBO_Bit2 = Lock/unlock the actuator for pushbutton
 (0 = unlock, 1 = lock)
 DBO_Bit1 = change between runtime in seconds or in 100 ms.
 (0 = runtime only in DB2 in seconds)
 (1 = runtime in DB3 (MSB) + DB2 (LSB) in 100 ms.)

Teach-in telegram BD3..DB0 must look like this: 0xFF, 0xF8, 0x0D, 0x80
 It is possible to interrupt at any time by pressing taught-in buttons!

FSR14-2x, FSR14-4x, FSR14M-2x, FSR14SSR, FSR71

Direct switching command, FUNC=38, Command 1, (like EEP A5-38-08). Separately for each channel.

There is the possibility to block the switching state with absolut priority so that it cannot be changed by other taught-in pushbuttons.

ORG = 0x07
 Data_byte3 = 0x01
 Data_byte2 = no used
 Data_byte1 = no used
 Data_byte0 = DBO_Bit3 = LRN Button
 (0 = teach-in telegram, 1 = data telegram)
 DBO_Bit2 = 1: **block switching state**,
 0: do not block switching state
 DBO_Bit0 = 1: switching output ON,
 0: switching output OFF

Teach-in telegram DB3..DB0 must look like this: 0xE0, 0x40, 0x0D, 0x80

Data telegrams have to look like date:

0x01, 0x00, 0x00, **0x09** (switching output ON, not blocked)
 0x01, 0x00, 0x00, **0x08** (switching output OFF, not blocked)
 0x01, 0x00, 0x00, **0x0D** (switching output ON, blocked)
 0x01, 0x00, 0x00, **0x0C** (switching output OFF, blocked)

FDG14, FDG71L, FKLD61, FLD61, FRGBW14, FRGBW71L, FSG14/1-10V, FSG71/1-10V, FSUD-230V, FUD14, FUD14-800W, FUD61NP, FUD61NPN, FUD71

Direct transfer of dimming value from 0 to 100%, similar to FUNC=38, Command 2 (like EEP A5-38-08).

ORG = 0x07
 Data_byte3 = 0x02
 Data_byte2 = dimming value in % from 0 to 100 dec.
 Data_byte1 = dimming speed
 0x00 = the dimming speed set on the dimmer is used.
 0x01 = very fast dimming speed to ...
 0xFF = very slow dimming speed
 Data_byte0 = DBO_Bit3 = LRN Button
 (0 =)
 DBO_Bit0 = 1: Dimmer ON, 0: Dimmer OFF.
 DBO_Bit2 = 1: Block dimming value
 0: Dimming value not blocked

Teach-in telegram BD3..DB0 must look like this: 0xE0, 0x40, 0x0D, 0x80
 only FSUD-230V: 0x02, 0x00, 0x00, 0x00

Data telegrams BD3..DB0 must look like this, for example:

0x02, 0x32, 0x00, 0x09 (dimmer on at 50% and internal dimming speed)
 0x02, 0x64, 0x01, 0x09 (dimmer on at 100% and fastest dimming speed)
 0x02, 0x14, 0xFF, 0x09 (dimmer on at 20% and slowest dimming speed)
 0x02, 0x.., 0x.., 0x08 (dimmer off)

ONLY FRGBW14, FRGBW71L AND FWWKW71L: FREE PROFILE (EEP 07-3F-7F)

Teach-in telegram DB3..DB0: 0xFF, 0xF8, 0x0D, 0x87

Confirmation telegram: DB3..DB0: 0xFF, 0xF8, 0x0D, 0x86

Data telegrams:

Data_byte0 = 0x0F = controller (FRGBW71L master)
 0x0E = confirmation telegram
 Data_byte1 = 0x02 = request confirmation telegram
 0x10 = dimming value red
 (DB3-DB2 = dimming value in 10Bit)
 0x11 = dimming value green
 (DB3-DB2 = dimming value in 10Bit)
 0x12 = dimming value blue
 (DB3-DB2 = dimming value in 10Bit)
 0x13 = dimming value white
 (DB3-DB2 = dimming value in 10Bit)
 0x30 = dim up
 (DB3 = dimming speed, DB2 = colour)
 Bit0 = red, Bit1 = green, Bit2 = blue, Bit3 = white)
 0x31 = dim down
 (DB3 = dimming speed, DB2 = colour)
 0x32 = dimming stop
 (DB3 = dimming speed, DB2 = colour)

data telegrams FWWKW71L:

Data_byte0 = 0x0F = controller (FWWKW71L master)
 0x0E = confirmation telegram
 Data_byte1 = 0x02 = request confirmation telegram
 0x10 = dimming value warm white
 (DB3-DB2 = dimming value in 10Bit)
 0x11 = dimming value cold white
 (DB3-DB2 = dimming value in 10Bit)
 0x30 = dim up
 (DB3 = dimming speed, DB2 = colour,
 Bit0 = warm white, Bit1 = cold white)
 0x31 = dim down
 (DB3 = dimming speed, DB2 = colour)
 0x32 = dimming stop
 (DB3 = dimming speed, DB2 = colour)

ACTIVATION TELEGRAMS FROM CONTROLLERS

FHK61SSR

Direct transfer of PWM value from 0 to 100%.

ORG = 0x07
 Data_byte3 = 0x02
 Data_byte2 = PWM value in % from 0 to 100 dec.
 Data_byte1 = PWM basic time T in 10 second steps
 from 1-100 dec., e.g. 12:T = 120 seconds
 Data_byte0 = DB0_Bit3 = LRN Button
 (0 = teach-in telegram, 1 = data telegram)
 DB0_Bit1 = 1: Repeater on, 0: Repeater off.
 DB0_Bit0 = 1: PWM on, 0: PWM off.
 Teach-in telegram DB3..DB0 have to look like this: 0xE0, 0x40, 0x00, 0x80
 Data telegrams DB3..DB0 have to look like this for example:
 0x02, 0x2D, 0x0A, 0x09 (PWM on with 45% and T = 100 seconds, repeater off)
 0x02, 0x64, 0x18, 0x09 (PWM on with 100% and T = 240 seconds, repeater off)
 0x02, 0x14, 0x12, 0x0B (PWM on with 20% and T = 180 seconds, repeater on)

FD62NP-230V, FD62NPN-230V

Direct transfer of dimming value from 0 to 100%, similar to FUNC=38, Command 2 (like EEP A5-38-08).

ORG = 0x07
 Data_byte3 = 0x02
 Data_byte2 = dimming value in % from 0 to 100 dec.
 Data_byte1 = dimming speed: 0x01 = very fast
 -0xFF = very slow
 Data_byte0 = DB0_Bit3 = LRN Button
 (0 = teach-in telegram, 1 = data telegram)
 DB0_Bit0 = 1: Dimmer ON, 0: Dimmer OFF.
 DB0_Bit2 = 1: Block dimming value, 0: Dimming value not blocked
 DB0_Bit5 = 1: Teach-in mode activation, 3x within 2s = delete controller ID
 Teach-in telegram: 0xE0400D80
 Unlock teach-in mode: 0x00000028
 Request confirmation telegram: 0x00000008

FJ62/12-36V DC, FJ62NP-230V

Direct drive command with specification of runtime in s. FUNC=3F, Typ=7F (universal).

ORG = 0x07
 Data_byte3 = Runtime in 100ms MSB
 Data_byte2 = Runtime in 100 ms LSB, or runtime in seconds
 1-255 dez.
 Data_byte1 = command: 0x00 = Stop, 0x01 = Up, 0x02 = Down
 Data_byte0 = DB0_Bit3 = LRN Button
 (0 = teach-in telegram, 1 = data telegram)
 DB0_Bit2 = Lock/unlock the actuator for pushbutton
 (0 = unlock, 1 = lock)
 DB0_Bit1 = change between runtime in seconds
 or in 100ms.
 (0 = runtime only in DB2 in seconds)
 (1 = runtime in DB3 (MSB) + DB2 (LSB) in 100ms.)
 DB0_Bit5 = 1: Teach-in mode activation, 3x within 2s = delete controller ID
 Teach-in telegram: 0xFFF80D80
 Unlock teach-in mode: 0x00000028

FL62-230V, FL62NP-230V, FR62-230V, FR62NP-230V

Direct switching command, FUNC=38, Command 1, (like EEP A5-38-08).

There is the possibility to **block** the switching state with absolut priority so that it cannot be changed by other taught-in pushbuttons.

ORG = 0x07
 Data_byte3 = 0x01
 Data_byte2 = no used
 Data_byte1 = no used
 Data_byte0 = DB0_Bit3 = LRN Button
 (0 = teach-in telegram, 1 = data telegram)
 DB0_Bit2 = 1: block switching state, 0: do not block switching state
 DB0_Bit0 = 1: switching output ON, 0: switching output OFF
 DB0_Bit5 = 1: Teach-in mode activation, 3x within 2s = delete controller ID
 Teach-in telegram: 0xE0400D80
 Unlock teach-in mode: 0x00000028
 Request confirmation telegram: 0x00000008

CONFIRMATION TELEGRAMS OF BIDIRECTIONAL ACTUATORS

FHK61U-230V

Every time the internal switching relay changes state, a PTM200 telegram containing the unique ID of the integrated TCM300 is sent after approx. 300 ms.

ORG = 0x05
 Data_byte3 = 0x70 = relay ON, 0x50 = relay OFF
 Remark: ON 0x00 (would be equivalent to button released) is never sent.

FHK61-230V, FHK61SSR-230V

PTM200 telegram
 ORG=0x05
 Data_byte3 = 0x70 = normal mode,
 0x50 = night reduction (-4°K)
 0x30 = setback mode (-2°K), 0x10 = OFF
 (frost protection active)

In addition every telegram received from a taught-in temperature sensor (e.g. B. FTR55H) is repeated as a confirmation telegram.

FHK61SSR-230V

Every time a PWM data telegram is received the same telegram is sent with the unique ID of the integrated TCM 300.

At activation or deactivation of the thaw signal input a PTM200 telegram containing the unique ID of the integrated TCM 300 will be sent.

Cyclically every 15 minutes a status signal will be sent.

ORG = 0x05
 Data_byte3 = 0x70 = thaw signal input active,
 0x50 = thaw signal input inactive

FMS61NP-230V

Every time the internal switching relay 1 changes state, a PTM200 telegram containing the unique ID of the integrated TCM300 is sent after approx. 300ms. Relay 2 sends this message after approx. 1000 ms.

With central commands (ZE/ZA), the relay state is also sent if the state already corresponds to the desired state.

ORG = 0x05
 Data_byte3 = 0x70 = channel 1 ON, 0x50 = channel 1 OFF
 0x30 = channel 2 ON, 0x10 = channel 2 OFF
 Remark: ON 0x00 (would be equivalent to button released) is never sent.

FMZ61-230V

Every time the the internal switching relay changes state, a PTM200 telegram containing the unique ID of the integrated TCM300 is sent after approx. 300-400 ms.

With central commands (ZE/ZA), the relay state is also sent if the state already corresponds to the desired state.

ORG = 0x05
 Data_byte3 = 0x70 = relay ON, 0x50 = relay OFF
 Remark: ON 0x00 (would be equivalent to button released) is never sent.

FSB61NP-230V, FSB71, FJ62/12-36V DC, FJ62NP-230V

ORG= 0x05
 Data_byte3 = 0x70 = upper stop position, 0x50 = lower stop position,
 0x01 = Start up, 0x02 = Start down

If the actuator is stopped before the end of RV, only the actual elapsed time is sent indicating the direction in a ORG7 message with the same ID! This is also the info that the engine has stopped now.

ORG = 0x07
 Data_byte3 = driving time in 100 ms MSB
 Data_byte2 = driving time in 100 ms LSB
 Data_byte1 = 0x01 = driven up or 0x02 = driven down
 Data_byte0 = 0x0A (not blocked) or 0x0E (blocked)

Remark: The RV time must be set on the device so that the end position is always reached. If the roller shutter is already at an end position, the relay is switched on receipt of a drive command anyway (0x01 or 0x02 is sent) and it is switched off on expiry of the RV. (0x70 or 0x50 is sent).

FLC61NP-230V, FSR61-230V, FSR61/8-24V, FSR61LN-230V, FSR61NP-230V, FSR61VA-10A, FSR71, FSSA-230V, FSVA-230V, FTN61NP-230V, FL62-230V, FL62NP-230V, FR62-230V, FR62NP-230V

Every time the the internal switching relay state changes, a PTM200 telegram containing the unique ID of the integrated TCM300 is sent after approx. 300-400 ms. With central commands (ZE/ZA) the relay state is also sent if the state already corresponds to the required state.

ORG = 0x05
 Data_byte3 = 0x70 = relay ON, 0x50 = relay OFF
 Remark: ON 0x00 (would be equivalent to button released) is never sent.

FDG71L, FRGBW71L, FSG71/1-10V, FSUD-230V, FUD61NP-230V, FUD61NPN-230V, FUD71, FD62NP-230V, FD62NPN-230V

Every time the dimmer is switched on or off, a PTM200 telegram containing the unique ID or base ID of the integrated TCM300 is sent after approx. 300-400 ms.

ORG = 0x05
 Data_byte3 = 0x70 = dimmer ON, 0x50 = dimmer OFF

In addition, approx. 1 second after reaching the required dimming value, a 4BS telegram containing the unique ID or base ID of the integrated TCM300 is also sent.

ORG = 0x07
 Data_byte3 = 0x02
 Data_byte2 = dimming value in % of 0-100 dec .
 Data_byte1 = 0x00
 Data_byte0 = 0x08 = dimmer OFF, 0x09 = dimmer ON.

Caution: No teach-in telegram containing ORG=7 can be generated.

Caution: Two telegram kinds (ORG=5, ORG=7) containing the same ID are sent!

only FRGBW71L: channel1 red = Base ID+1
 channel2 green = Base ID+2
 channel3 blue = Base ID+3
 channel4 white = Base ID+4
 all channels = Base ID+5
 Master telegramm = Base ID+6

only FWWKW71L: channel1 warm white = Base ID+1
 channel2 cold white = Base ID+2
 all channels = Base ID+3
 Master telegramm = Base ID+4

To teach-in reply confirmation telegrams of bidirectional actuators into other actuators or into the controller the local control input has to be used to change the switching position and to simultaneously send the confirmation telegrams.

SERIES 14 CONFIRMATION TELEGRAM

As soon as Series 14 actuators receive a device address, the FAM14 can request actuators for confirmation telegrams. The confirmation telegrams are then radioed by the FAM14. The ID of the radioed telegrams is identical to the Base ID of the TCM300 in the FAM14 plus the device address. Multichannel actuators have consecutive device addresses corresponding to the number of channels.

Note: Depending on the number of actuators on the bus, there may be a time lapse of up to 10 seconds before a confirmation telegram is requested and radioed. If fast confirmation is expected by certain actuators, a device list for confirmation telegrams must be generated via the PCT14. The actuator must be entered several times in the device list. The FAM14 must then be operated in operating mode 5.

CONFIRMATION TELEGRAMS OF BIDIRECTIONAL ACTUATORS.

FDG14, FRGBW14, FSG14/1-10V, FUD14, FUD14/800W

Here you can select 2 confirmation telegrams in the PCT14 configuration independently of each other.

1. PTM200 telegram ORG=0x05
Data_byte3: 0x70 = Dimmer ON,
0x50 = Dimmer OFF
2. 4BS telegram with dimming value
ORG = 0x07
Data_byte3 = 0x02
Data_byte2 = Dimming value in %
Data_byte1 = 0x00
Data_byte0 = 0x08 = Dimmer OFF,
0x09 = Dimmer ON

FSB14

Per channel: PTM200 telegram
ORG=0x05
Data_byte3 = 0x70 = end position top,
0x50 = end position bottom
0x01 = start up,
0x02 = start down

If the actuator is stopped before the end of RV, only the actual elapsed time is sent indicating the direction in a ORG7 message with the same ID! This is also the info that the engine has stopped now.

ORG = 0x07
Data_byte3 = driving time in 100ms MSB
Data_byte2 = driving time in 100ms LSB
Data_byte1 = 0x01 = driven up or 0x02 = driven down
Data_byte0 = 0x0A (not blocked) or 0x0E (blocked)

Remark: The RV time must be set on the device so that the end position is always reached. If the roller shutter is already at an end position, the relay is switched on receipt of a drive command anyway (0x01 or 0x02 is sent) and it is switched off on expiry of the RV. (0x70 or 0x50 is sent).

FAE14LPR, FAE14SSR, F4HK14, FHK14

Per channel: PTM200 telegram
ORG=0x05
Data_byte3 = 0x70 = normal mode,
0x50 = night reduction (-4°K)
0x30 = setback mode (-2°K), 0x10 = OFF
(frost protection active)

In addition every telegram received from a taught-on temperature sensor (e.g. FTR55H) is repeated as a confirmation telegram.

FMSR14

The FMSR14 evaluates the MS multisensor data which is fed to the Eltako wireless network by the FWS61 transmitter module.

The data contains measured values for sunlight from 3 cardinal points, light values to evaluate twilight, and wind speed in m/s.

In addition there are signals for rain and frost.

The device occupies 5 device addresses, providing confirmation telegrams for each of the 3 parameters and the 2 signals containing confirmation telegrams with an individual ID.

Limits can be set using the PCT14 configuration for the measured values of sunlight, twilight and wind speed. If these parameters are exceeded or overshot, telegrams containing Data_byte3 = 0x70 or 0x50 (selectable) are generated.

As soon as the limits are no longer exceeded or overshot, a telegram containing Data_byte3 = 0x00 is generated.

The signals for frost and rain are also converted into telegrams containing Data_byte3 = 0x70 or 0x50 (selectable).

When the signals are cancelled, telegrams containing Data_byte3 = 0x00 are generated.

FSU14

The 8 timer channels correspond to the 8 device addresses of the FSU14. Switch on/off commands are generated in the form of confirmation telegrams depending on the programmed switching times for the individual channels:

PTM200 telegrams ORG=0x05
Data_byte3 = 0x70 = switch ON,
0x50 = switch OFF

Clock telegram (EEP A5-13-04) with the current time (hour and minute) and the day of the week.

Teach-in clock telegram DB3..DB0: 0x4C, 0x20, 0x0D, 0x80

F2L14, FMS14, FMZ14, FSR14-2x, FSR14-4x, FSR14M-2x, FSR14SSR, FTN14

With multichannel actuators per channel:

PTM200 telegram ORG=0x05
Data_byte3: 0x70 = relay ON, 0x50 = relay OFF



S

ALL SPECIFICATIONS AT A GLANCE.

Type comparison table, warranty regulations, terms of delivery and index

Type comparison table	S-2
Warranty regulations	S-4
Terms of delivery	S-4
Index	S-5

TYPE COMPARISON TABLE

FOR ELTAKO SERIES 11 IN COMPARISON WITH THE UP-TO-DATE SERIES 12.

Devices of Series 12, which have not existed in former series and which have still the same type name, are not listed here.

ELECTRONIC IMPULSE SWITCHES				
Series 11	Series 12	Changes	Up-to-date	Page
	ES12-8..230V, 8..24V, 230V,12V	ES12-100-	ES12DX-	11-3
ES11-100-	ES12-100-		ES12DX-	11-3
	ES12-001-		ES12-110-	11-6
ES11-110-	ES12-110-		ES12-110-	11-6
ES11-200-	ES12-200-		ES12-200-	11-5
	ES12-2x-	ES12M-	ESR12DDX-	11-8
	ESR12M-		ESR12DDX-	11-8
	ES12-400-	ES12-4x	ESR12Z-4DX-	11-10
		ES12Z-4x	ESR12Z-4DX-	11-10
	ES12NP-		ESR12NP-	11-7
ES11.2-001-	ES12.2-001-		ES12Z-110-	11-9
ES11.3-	ES12Z-		ES12Z-200-	11-9
ES11.4-	ES12Z-		ES12Z-200-	11-9
ES11.1-	ES12.9-	ESV12NP-	ESR12NP-	11-7
	ESV12-		ESR12NP-	11-7
	ESV12.1-		ESR12NP-	11-7
		ES12.1NP	ES12Z-200-	11-9
	ES12.1-8..230V		ES12Z-200-	11-9
ES11.2-100-	ES12.2-100-	ES12Z-100-	ES12Z-200-	11-9
ES11.2-110-	ES12.2-110-		ES12Z-110-	11-9
ES11.2-200-	ES12.2-200-		ES12Z-200-	11-9
	ES12.3-001-	ES12.1-110-	ES12Z-110-	11-9
	ES12.4-001-		ES12Z-110-	11-9
	ES12.5-001-		ES12Z-110-	11-9
	ES12.6-200-	ES12.1-200-	ES12Z-200-	11-9
	ES12.7-200-		ES12Z-200-	11-9
	ES12.8-200-	ES12.1-200-	ES12Z-200-	11-9
	S12.2-, XS12.2-		ES12Z-	11-9
	ES12.1-500-	ES12.1-4x-	ESR12Z-4DX-	11-10
	ES12.1-400-		ESR12Z-4DX-	11-10
	S12.3-, XS12.3-	ES12Z-4x	ESR12Z-4DX-	11-10
UNIVERSAL DIMMER SWITCHES				
Series 12	Changes	Changes	Up-to-date	Page
ESD12-	ESD12U-		EUD12NPN-	9-3
ESD12.2-	ESD12.2U-	EUD12Z-	EUD12D-	9-4
ESV12.2P-	ES12.1P-/ EUD12M-		EUD12D-	9-4
ESD12.2- +ELD12-	ESD12.2U- +EUL12-	EUD12Z- +LUD12-	EUD12D- +LUD12-	9-4 9-7
ESD12UF			EUD12F	9-5

ELECTRONIC SWITCHING RELAYS, CONTROL RELAYS AND COUPLING RELAYS				
Series 11	Series 12	Changes	Up-to-date	Page
ER11-001-	ER12-001-		ER12-001-	12-5
	ER12-100-		ER12DX-	12-3
ER11-200-	ER12-200-		ER12-200-	12-4
ER11-002-	ER12-002-		ER12-002-	12-5
EKR11-001-	EKR12-001-		ER12-001-	12-5
	ER12P-	EUD12M-	EUD12D-	9-4
	ER12NP-		ESR12NP-	12-7
	ER12M-	ESR12M-	ESR12DDX-	12-8
ELECTROMECHANICAL IMPULSE SWITCHES				
Series 11	Series 12	Changes	Up-to-date	Page
S11-100-	S12-100-		S12-100-	18-2
S11-110-	S12-110-		S12-110-	18-2
S11-200-	S12-200-		S12-200-	18-2
SS11-110-	SS12-110-		SS12-110-	18-2
GS11-110-	GS12-110-		ESR12DDX-	11-8
S11-400-	S12-400-		S12-400-	18-3
S11-310-	S12-310-		S12-310-	18-3
S11-220-	S12-220-		S12-220-	18-3
ELECTROMECHANICAL SWITCHING RELAYS				
Series 11	Series 12	Changes	Up-to-date	Page
R11-100-	R12-100-		R12-100-	19-2
R11-110-	R12-110-		R12-110-	19-2
R11-200-	R12-200-		R12-200-	19-2
R11-020-	R12-020-230 V		R12-020-230 V	19-2
R11-400-	R12-400-		R12-400-	19-2
R11-310-	R12-310-		R12-310-	19-2
R11-220-	R12-220-		R12-220-	19-2
VR11-	VR12-		ER12-	12-4 12-5
STAIRCASE TIME SWITCHES, OFF-DELAY TIMERS				
Series 12	Changes	Changes	Up-to-date	Page
TLZ12.0-	TLZ12E-	TLZ12-8E	TLZ12-8plus	15-3
TLZ12.0E-		TLZ12-8E	TLZ12-8plus	15-3
TLZ12-	TLZ12NP	TLZ12D-	TLZ12D-plus	15-6
TLZ12.1-	TLZ12M	TLZ12D-	TLZ12D-plus	15-6
TLZ12.2-		TLZ12-8E	TLZ12-8plus	15-3
TLZ12.3-		TLZ12-8E	TLZ12-8plus	15-3
TLZ12.4-	TLZ12M.1	TLZ12D-	TLZ12D-plus	15-6
		TLZ12-8E-230 V +8..230 V UC	TLZ12-8plus	15-3
TLZ12.9-		TLZ12-9E	TLZ12-9	15-7
TLZ12.4P-	TLZ12P-/ EUD12M-		EUD12D-	9-4

FOR ELTAKO SERIES 11 IN COMPARISON WITH THE UP-TO-DATE SERIES 12 AND 15.

Devices of Series 12, which have not existed in former series and which have still the same type name, are not listed here.

MAINS DISCONNECTING RELAYS				
Series 11	Series 12	Changes	Up-to-date	Page
FR11-100-	FR12-100-	FR12.1-	FR12-	14-3
	FR12.0-		FR12-	14-3
TIME RELAYS				
Series 11	Series 12	Changes	Up-to-date	Page
MFZ11-	MFZ12-	MFZ12.1-	MFZ12DX-	13-4
EZ11.2-	EZ12.2-	EZ12RV-	RVZ12DX-	13-14
EZ11.3-	EZ12.3-	EZ12AV-	AVZ12DX-	13-11
EZ11.4-	EZ12.4-	EZ12TI-	TGI12DX-	13-15
EZ11.5-	EZ12.5-	EZ12EW-	EAW12DX-	13-12
	EZ12EAW-		EAW12DX-	13-12
EZ11.6-	EZ12.6-	EZ12AW-	EAW12DX-	13-12
	EZ12.9-	EZ12SRV-	MFZ12DX-	13-4
		EZ12ARV-	MFZ12DX-	13-4
		DMZ12	MFZ12DDX-	13-6
	DMZ12-	DMZ12.1-	MFZ12DDX-	13-6
	DZ12.2-	DZ12RV-	MFZ12DDX-	13-6
	DZ12.3-	DZ12AV-	MFZ12DDX-	13-6
	DZ12.4-	DZ12TI-	MFZ12DDX-	13-6
	DZ12.5-	DZ12EW-	MFZ12DDX-	13-6
	DZ12.6-	DZ12AW-	MFZ12DDX-	13-6
	DZ12.9-	DZ12SRV-	MFZ12DDX-	13-6
	TI12P-	EUD12M-	EUD12D-	9-4
SHADING SYSTEMS AND ROLLER SHUTTER CONTROL				
Series 11	Series 12	Changes	Up-to-date	Page
EGS11.2/.3-	EGS12-200-	EGS12.1-	EGS12Z-	16-6
EGS11.2/.3-	EGS12-200-	EGS12.2-	EGS12Z2-	16-7
	USR12-*		MSR12-	16-4
	LSR12-	LDW12-	LRW12D-	16-5
	MTR12-400		MTR12-	16-7

SINGLE-PHASE ENERGY METERS				
Series 12	Changes	Changes	Up-to-date	Page
WSZ12-20A	WSZ12-32A	WSZ12DE-32A	WSZ15DE-32A	10-18
WSZ12B-20A	WSZ12B-25A	WSZ12D-32A	WSZ15D-32A MID	10-18
WSZ12-65A	WSZ12B-65A	WSZ12D-65A	WSZ15D-65A MID	10-19
	EWZ12-32A	WSZ12DE-32A	WSZ15DE-32A	10-18
THREE-PHASE ENERGY METERS				
Series 12	Changes	Changes	Up-to-date	Page
DSZ12B-3x65A	DSZ12D-3x65A	DSZ12D-3x80A	DSZ15D-3x80A MID	10-3
DSZ12B-T2-3x65A	DSZ12D-3x65A	DSZ12D-3x80A	DSZ15D-3x80A MID	10-3
EDZ12B-3x65A	DSZ12D-3x65A	DSZ12D-3x80A	DSZ15D-3x80A MID	10-3
EDZ12B-T2-3x65A	DSZ12D-3x65A	DSZ12D-3x80A	DSZ15D-3x80A MID	10-3
EDZ12WB-5A		DSZ12WD-3x5A	DSZ15WD-3x5A MID	10-6
EDZ12WS-5A		DSZ12WD-3x5A	DSZ15WD-3x5A MID	10-6
ON/OFF SWITCHES, MOMENTARY CONTACT SWITCHES, INDICATOR LIGHTS				
Series 11	Series 12	Changes	Up-to-date	Page
	PK12-3-		P3K12-	14-9

* If controlled only by a LS and/or WS the USR12- can also be replaced by a LRW12D-. The MSR12- needs a multi sensor MS.

FOR ELTAKO SERIES 8, 9 AND 60 IN COMPARISON WITH THE UP-TO-DATE SERIES 81, 91 AND 61.

CONTROL RELAYS				
Series 60	Series 61	Changes	Up-to-date	Page
ER60-	ER61-		ER61-	12-11
IMPULSE SWITCHES/STAIRCASE TIME SWITCHES/ OFF-DELAY TIMERS				
Series 60	Series 61	Changes	Up-to-date	Page
ES60-	ES61-		ES61-	11-11
ES60.1-	ES61.9-	ESV61-	ESR61NP-	11-12
	ESD61-		EUD61NPN-	9-15
EZ60/TLZ60-	TLZ61-		TLZ61NP-230V	15-8
	TLZ61.1-4-	TLZ61NP-8..230V UC	TLZ61NP-230V+UC	15-9
EZ60.2/NLZ60-	NLZ61-		NLZ61NP-UC	15-12
	NLZ61.1-	NLZ61NP-8..230V UC	NLZ61NP-UC	15-12

IMPULSE SWITCHES/SWITCHING RELAYS				
Series 9	Series 91	Changes	Up-to-date	Page
1S9-	S91-100-		S91-100-	18-4
1R9-	R91-100-		R91-100-	19-3
Series 8	Series 81	Changes	Up-to-date	Page
2S8-	S81-002-		S81-002-	18-4
WS8-	S81-002-		S81-002-	18-4
SS8-	SS81-002-		ESR61M-UC	11-13
GS8-	GS81-002-		ESR61M-UC	11-13
2R8-	R81-002-		R81-002-	19-3
WR8-	R81-002-		R81-002-	19-3
RR8-	R81-002-		R81-002-	19-3

WARRANTY REGULATIONS FOR THE ELECTRICAL TRADES IN GERMANY.

We have been offering a two-year warranty period for all Eltako products since 1956. Since 2004, due to an agreement between the ZVEI, VEG and the ZVEH, further improved warranty rules have applied to the electrical trades in Germany.

- **For deliveries from 1.1.2019, an extended warranty period of 5 years from the date of manufacture applies to products delivered by us with the Eltako label.**
- If a defective product is acknowledged, Eltako will deliver a replacement free of charge within a very short time. Should delivery of the same product not be possible in the case of a model upgrade or due to technical progress, goods of the same type and quality can also be delivered as replacement.

TERMS OF DELIVERY.

We exclusively deliver to the general conditions for products and services of the (German) electrical industry, as at May 2021, and to our current price list.

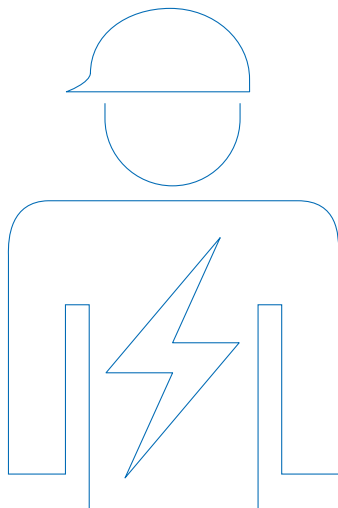

Only a trained electrician may install our switchgear, power supply units and energy meters with mains voltage connection, otherwise there is a risk of fire or electric shock. It is therefore prohibited to sell to other customers for this reason otherwise the risk passes to the seller.

TYPE	MEANING	ART. NO.	EAN	LIST PRICE	CHAPTER
A					
A2Z12-UC	Analogue settable 2-stage ON-delay	23200302	4010312603178	79,80 €	13-10
AIR	IR scanner for energy meters	30000970	4010312316153	111,10 €	1-33, 5-39, 10-16
AR12DX-230V	Current relay	22001130	4010312205426	71,40 €	14-6
ASSU-BT/230V	Outdoor socket timer, 1 NO contact 16A	30000660	4010312328187	101,80 €	13-18
AVZ12DX-UC	AV operate delay	23001302	4010312603109	68,00 €	13-11
B					
B4T55E-am	Bus 2- or 4-way pushbutton in E-Design55, anthracite mat	30055650	4010312326152	59,80 €	2-9, 5-10
B4T55E-pg	Bus 2- or 4-way pushbutton in E-Design55, polar white glossy	30055651	4010312326046	59,80 €	2-9, 5-10
B4T55E-pm	Bus 2- or 4-way pushbutton in E-Design55, polar white mat	30055652	4010312326039	59,80 €	2-9, 5-10
B4T55E-wg	Bus 2- or 4-way pushbutton in E-Design55, pure white glossy	30055653	4010312326022	59,80 €	2-9, 5-10
BBH55E/12VDC-am	Bus motion/brightness sensor, anthracite mat	30055152	4010312326541	78,20 €	2-18, 5-12
BBH55E/12VDC-pg	Bus motion/brightness sensor, polar white glossy	30055153	4010312326558	78,20 €	2-18, 5-12
BBH55E/12VDC-pm	Bus motion/brightness sensor, polar white mat	30055154	4010312326565	78,20 €	2-18, 5-12
BBH55E/12VDC-wg	Bus motion/brightness sensor, pure white glossy	30055155	4010312326572	78,20 €	2-18, 5-12
BBV14	Bus jumper connector	30014053	4010312315248	24,30 €	1-44
BBV14/100	BBV14/100 Bus jumper connector 4-core wire, 100cm	30014058	4010312324660	25,50 €	1-44
BGW14	RS485 bus gateway	30014046	4010312319062	64,90 €	2-17
BLA55-rw	Blind cover	30000642	4010312905883	4,40 €	5-21
BLA55-wg	Blind cover	30000645	4010312905913	4,40 €	5-21
BLA55E-am	Blind cover	30055640	4010312909225	4,40 €	5-15
BLA55E-pg	Blind cover	30055641	4010312909232	4,40 €	5-15
BLA55E-pm	Blind cover	30055643	4010312909249	4,40 €	5-15
BLA55E-wg	Blind cover	30055645	4010312908822	4,40 €	5-15
BPB55	Blistepack shading	30000035	4010312317822	153,30 €	3-34
BPB55-J62	Blistepack shading	30001067	4010312324295	122,00 €	3-12
BPD55	Blistepack dimming	30000036	4010312317839	169,10 €	3-33
BPD55-D62	Blistepack dimming	30001066	4010312324271	136,80 €	3-12
BPS55	Blistepack switching	30000037	4010312317846	139,70 €	3-32
BPS55-L62	Blistepack switching	30001065	4010312323991	119,70 €	3-11
BTF55E/12VDC-am	Bus temperature sensor, anthracite mat	30055156	4010312326589	66,80 €	2-18, 5-12
BTF55E/12VDC-pg	Bus temperature sensor, polar white glossy	30055157	4010312326596	66,80 €	2-18, 5-12
BTF55E/12VDC-pm	Bus temperature sensor, polar white mat	30055158	4010312326602	66,80 €	2-18, 5-12
BTF55E/12VDC-wg	Bus temperature sensor, pure white glossy	30055159	4010312326619	66,80 €	2-18, 5-12
BTR55EH/12VDC-am	Bus temperature controller with hand wheel, anthracite mat	30055160	4010312326626	72,70 €	2-18, 5-12
BTR55EH/12VDC-pg	Bus temperature controller with hand wheel, polar white glossy	30055161	4010312326633	72,70 €	2-18, 5-12
BTR55EH/12VDC-pm	Bus temperature controller with hand wheel, polar white mat	30055162	4010312326640	72,70 €	2-18, 5-12
BTR55EH/12VDC-wg	Bus temperature controller with hand wheel, pure white glossy	30055163	4010312326657	72,70 €	2-18, 5-12
BUTH55ED/12VDC-am	Bus thermo clock/hygrostat with display, anthracite mat	30055164	4010312326664	91,80 €	2-18, 5-12
BUTH55ED/12VDC-pg	Bus thermo clock/hygrostat with display, polar white glossy	30055165	4010312326671	91,80 €	2-18, 5-12
BUTH55ED/12VDC-pm	Bus thermo clock/hygrostat with display, polar white mat	30055166	4010312326688	91,80 €	2-18, 5-12
BUTH55ED/12VDC-wg	Bus thermo clock/hygrostat with display, pure white glossy	30055167	4010312326695	91,80 €	2-18, 5-12
BW3	Mounting brackets	30000412	4010312907641	3,90 €	5-36
BZR12DDX-UC	Operating hours impulse counter	22001430	4010312603161	69,10 €	14-5
D					
DALI Cockpit und DALI-Monitor	Software				7-25
DAT71	Data transformer	30000026	4010312316351	78,80 €	3-49
DCM12-UC	DC motor relay	22400602	4010312205310	71,40 €	16-7
DL-1CH-8A-DC12+	1 channel DALI LED dimmer 8 A	33000015	4010312321515	127,80 €	7-5
DL-1CH-16A-DC12+	1 channel DALI LED dimmer 16 A	33000016	4010312321522	146,50 €	7-6
DL-1CH-R16A-DC12+	1 channel DALI LED dimmer 16 A	33000022	4010312321584	147,90 €	7-7
DL-3CH-8A-DC12+	3 channels DALI LED dimmer 8 A	33000017	4010312321546	143,40 €	7-14
DL-3CH-16A-DC12+	3 channels DALI LED dimmer 16 A	33000018	4010312321539	161,40 €	7-15
DL-3CH-R16A-DC12+	3 channels DALI LED dimmer 16 A	33000024	4010312321607	161,40 €	7-16
DL-4CH-8A-DC12+	4 channels DALI LED dimmer 8 A	33000019	4010312321553	157,00 €	7-17
DL-4CH-16A-DC12+	4 channels DALI LED dimmer 16 A	33000020	4010312321560	174,90 €	7-18
DL-4CH-R16A-DC12+	4 channels DALI LED dimmer 16 A	33000021	4010312321577	190,60 €	7-19
DL-CTV	DALI control unit for controlling the circadian course of daylight	33000001	4010312321430	311,60 €	7-24
DL-Flash-USB	DALI USB interface	33000025	4010312321614	414,40 €	7-26
DL-N2-80mA	DALI bus power supply unit	33000026	4010312327685	92,60 €	3-6, 7-3
DL-PD-300W-RLC	Phase dimmer with DALI control input (DT4)	33000009	4010312324028	228,80 €	7-22
DL-PD-300W-RLC-HS	Phase dimmer with DALI control input (DT4)	33000008	4010312324073	228,80 €	7-23
DL-RGB-8A-DC12+	DALI LED dimmer 8 A RGB	33000013	4010312321492	159,00 €	7-11
DL-RGB-16A-DC12+	DALI LED dimmer-LED-Dimmer 16 A RGB	33000014	4010312321508	199,50 €	7-12
DL-RGB-R16A-DC12+	DALI LED dimmer 16 A RGB	33000023	4010312321591	199,50 €	7-13
DL-RM8A	DALI2 relay module 8 A for flush-mounted box (DT7)	33000007	4010312324035	150,20 €	7-20
DL-RM16A-HS-WE	DT7 switching actuator	33000006	4010312324042	174,90 €	7-21
DL-TW-2LT-8A-DC12+	DALI LED dimmer 8 A tunable white	33000010	4010312321461	143,50 €	7-8

INDEX

TYPE	MEANING	ART. NO.	EAN	LIST PRICE	CHAPTER
DL-TW-2LT-16A-DC12+	DALI2-LED-Dimmer 16 A tunable white	33000011	4010312321478	172,50 €	7-9
DL-TW-2LT-R16A-DC12+	DALI-LED-Dimmer 16 A tunable white	33000012	4010312321485	186,20 €	7-10
DL-USB mini	DALI USB interface	33000002	4010312321447	408,10 €	7-26
DS12	Spacer	20000010	4010312900987	2,10 €	2-3
DS14	Spacer	30014101	4010312907016	2,10 €	1-44, 2-3
DSS55E-am	German Socket (Type F) with socket outlet front in E-Design55	30055898	4010312323823	8,40 €	5-14
DSS55E-pg	German Socket (Type F) with socket outlet front in E-Design55	30055893	4010312325599	8,40 €	5-14
DSS55E-pm	German Socket (Type F) with socket outlet front in E-Design55	30055894	4010312325605	8,40 €	5-14
DSS55E-wg	German Socket (Type F) with socket outlet front in E-Design55	30055895	4010312320082	8,40 €	5-14
DSS55EOKR-am	German Socket (Type F) with socket outlet front in E-Design55 without frame	30057898	4010312327898	8,30 €	5-14
DSS55EOKR-pg	German Socket (Type F) with socket outlet front in E-Design55 without frame	30057893	4010312327821	8,30 €	5-14
DSS55EOKR-pm	German Socket (Type F) with socket outlet front in E-Design55 without frame	30057894	4010312327838	8,30 €	5-14
DSS55EOKR-wg	German Socket (Type F) with socket outlet front in E-Design55 without frame	30057895	4010312327845	8,30 €	5-14
DSS55EOR-am	German Socket (Type F) with socket outlet front in E-Design55 without frame	30056898	4010312327630	7,50 €	5-14
DSS55EOR-pg	German Socket (Type F) with socket outlet front in E-Design55 without frame	30056893	4010312327791	7,50 €	5-14
DSS55EOR-pm	German Socket (Type F) with socket outlet front in E-Design55 without frame	30056894	4010312327807	7,50 €	5-14
DSS55EOR-wg	German Socket (Type F) with socket outlet front in E-Design55 without frame	30056895	4010312327616	7,50 €	5-14
DSS55E+2xUSBA-am	German Socket (Type F) with 2xUSB-A in E-Design55	30055899	4010312324301	42,40 €	5-14
DSS55E+2xUSBA-pg	German Socket (Type F) with 2xUSB-A in E-Design55	30055891	4010312325575	42,40 €	5-14
DSS55E+2xUSBA-pm	German Socket (Type F) with 2xUSB-A in E-Design55	30055892	4010312325582	42,40 €	5-14
DSS55E+2xUSBA-wg	German Socket (Type F) with 2xUSB-A in E-Design55	30055896	4010312322512	42,40 €	5-14
DSS55E+USBA+C-am	German Socket (Type F) with USB-A and USB-C in E-Design55	30055900	4010312324318	50,30 €	5-14
DSS55E+USBA+C-pg	German Socket (Type F) with USB-A and USB-C in E-Design55	30055901	4010312325612	50,30 €	5-14
DSS55E+USBA+C-pm	German Socket (Type F) with USB-A and USB-C in E-Design55	30055902	4010312325629	50,30 €	5-14
DSS55E+USBA+C-wg	German Socket (Type F) with USB-A and USB-C in E-Design55	30055897	4010312323830	50,30 €	5-14
DSS+SD055-rw	German Socket (Type F) with socket outlet front	30000652	4010312310854	9,20 €	5-21
DSS+SD055-wg	German Socket (Type F) with socket outlet front	30000655	4010312310885	9,60 €	5-21
DSZ14DRS-3x80A MID	RS485 bus wireless three-phase energy meter with display, MID	28365715	4010312501733	200,50 €	1-30, 10-10
DSZ14DRSZ-3x80A MID	RS485 bus bidirectional three-phase meter, with MID	28465715	4010312501887	232,20 €	1-31, 10-11
DSZ14WDRS-3x5A MID	RS485 bus wireless three-phase energy meter, MID	28305712	4010312501450	209,10 €	1-32, 10-12
DSZ15D-3x80A MID	Three-phase energy meter, MID	28380015	4010312501634	157,60 €	10-3
DSZ15DE-3x80A	Three-phase energy meter, without MID	28380615	4010312501719	116,00 €	10-3
DSZ15DM-3x80A MID	M-bus three-phase energy meter, MID	28380512	4010312501726	243,70 €	10-7
DSZ15DZ-3x80A MID	Bidirectional three-phase meter, MID	28480315	4010312501870	210,90 €	10-4
DSZ15DZE-3x80A	Bidirectional three-phase meter, without MID	28380215	4010312501894	180,00 €	10-5
DSZ15DZMOD-3x80A MID	Modbus bidirectional three-phase meter, MID	28380516	4010312328170	243,70 €	10-9
DSZ15WD-3x5A MID	CT operated three-phase energy meter, MID	28305015	4010312501841	204,10 €	10-6
DSZ15WDM-3x5A MID	CT operated three-phase energy meter, MID	28305515	4010312501665	243,70 €	10-8
DSZ180CEE-16A MID	Mobile three-phase energy meter, MID	28016128	4010312501863	213,70 €	10-13
DSZ180CEE-32A MID	Mobile three-phase energy meter, MID	28032128	4010312501825	225,50 €	10-13
DW-F4T55E	Double rocker for wireless pushbuttons E-Design55	30055952	4010312908426	8,80 €	5-41
DW-F4T55E/10-am	10x Rocker for wireless pushbutton and wireless pushbutton with battery in E-Design55	30055956	4010312909508	20,60 €	5-41
DW-F4T55E/10-pg	10x Rocker for wireless pushbutton and wireless pushbutton with battery in E-Design55	30055958	4010312909553	20,60 €	5-41
DW-F4T55E/10-pm	10x Rocker for wireless pushbutton and wireless pushbutton with battery in E-Design55	30055959	4010312909560	20,60 €	5-41
DW-F4T55E/10-wg	10x Rocker for wireless pushbutton and wireless pushbutton with battery in E-Design55	30055957	4010312909492	20,60 €	5-41
DW-F4T55Eam+2P	Double rocker for wireless pushbuttons E-Design55, arrow top (up) and bottom (down)	30055955	4010312909409	8,80 €	5-41
DW-F4T55Ewg+2P	Double rocker for wireless pushbuttons E-Design55, arrow top (up) and bottom (down)	30055954	4010312909393	8,80 €	5-41
DW-FF8	Double rocker for wireless remote control	30000962	4010312906378	8,80 €	5-43
DW-FHS/FMH4	Double rocker for wireless mini handheld transmitters FMH4	30000961	4010312906361	8,80 €	5-43
DW-FMT55/4	Double rocker for wireless mini pushbuttons	30000958	4010312906330	8,80 €	5-42
DW-FT4CH	Double rocker for wireless pushbuttons Swiss Design	30000963	4010312906385	8,80 €	5-42
DW-FT4B-	Double rocker for wireless pushbutton 45x45mm, Belgian	30000964	4010312906392	8,80 €	5-42
DW-FT4F	Double rocker for wireless flat pushbuttons	30000952	4010312906279	8,80 €	5-42
DW-FT55	Double rocker for wireless pushbuttons 55 x 55 mm	30000954	4010312906293	8,80 €	5-42
DW-FT55R	Double rocker for wireless pushbuttons 55 x 55 mm for Busch Reflex Duro	30000968	4010312907061	8,80 €	5-43
DW-W2T55	Double rocker for rocker pushbutton	30000977	4010312908433	8,80 €	5-43
E					
EAW12DX-UC	Fleeting NO contact and fleeting NC contact	23001702	4010312603123	67,60 €	13-12
EGS12Z2-UC	Impulse group switch	21400401	4010312108031	99,70 €	16-7
EGS12Z-UC	Impulse group switch	21200401	4010312107737	78,40 €	16-6
EGS61Z-230V	Impulse group switch	61200430	4010312108123	74,50 €	16-8
ELD61/12-36VDC	LED dimmer switch	61100865	4010312109502	62,50 €	9-18
ER12-110-UC	Switching relay	22110002	4010312205440	57,10 €	12-4
ER12-200-UC	Switching relay	22200002	4010312205433	57,10 €	12-4
ER12-001-UC	Switching relay	22001601	4010312205365	55,70 €	12-5
ER12-002-UC	Switching relay	22002601	4010312205372	62,80 €	12-5
ER12DX-UC	Switching relay	22100002	4010312205402	56,30 €	12-3

TYPE	MEANING	ART. NO.	EAN	LIST PRICE	CHAPTER
ER12SSR-UC	Switching relays noiseless with solid state relay	22100001	4010312206720	51,40 €	12-6
ER61-UC	Switching relay	61001601	4010312205358	54,70 €	12-11
ES12-110-UC	Impulse switch with integrated relay function	21110002	4010312108055	58,20 €	11-6
ES12-200-UC	Impulse switch with integrated relay function	21200002	4010312108048	59,10 €	11-5
ES12DX-UC	Impulse switch with integrated relay function	21100002	4010312107959	56,90 €	11-3
ES12Z-110-UC	Impulse switch with integrated relay function	21110601	4010312107683	68,20 €	11-9
ES12Z-200-UC	Impulse switch with integrated relay function	21200601	4010312107690	68,20 €	11-9
ES61-UC	Impulse switch with integrated relay function	61100501	4010312107966	57,90 €	11-11
ES75-12..24V UC	Impulse switch for installation in lighting fittings	60100055	4010312101063	61,00 €	11-11
ESB62NP-IP/110-240V	Shading actuator IP	30062003	4010312324707	70,70 €	8-5
ESR12DDX-UC	Multifunction impulse switch with integrated relay function	21200302	4010312108093	76,10 €	11-8, 12-8
ESR12NP-230V+UC	Impulse switch with integrated relay function	21100102	4010312107928	61,10 €	11-7, 12-7
ESR12Z-4DX-UC	Impulse switch with integrated relay function	21400301	4010312108130	106,70 €	11-10
ESR61M-UC	Multifunction impulse switch with integrated relay function	61200301	4010312108079	71,90 €	11-13, 12-12
ESR61NP-230V+UC	Impulse switch with integrated relay function	61100001	4010312107911	58,10 €	11-12, 12-11
ESR61SSR-230V	Impulse switch with integrated relay function with solid state relay	61100003	4010312109786	55,90 €	11-14, 12-13
ESR62NP-IP/110-240V	Impulse switch with integrated relay function IP	30062001	4010312324677	61,10 €	8-2
ESR62PF-IP/110-240V	Impulse switch with integrated relay function IP	30062004	4010312324684	58,20 €	8-3
ESW12DX-UC	Impulse switch	21100801	4010312206744	57,20 €	11-4
ETR61-230V	Isolating relay	61100635	4010312206690	45,60 €	12-14
ETR61NP-230V	Isolating relay	61100630	4010312205488	45,60 €	12-14
ETR61NP-230V+FK	Isolating relay with window contact	61100631	4010312205495	78,40 €	12-15
EUD12D-UC	Multifunction universal dimmer switch	21100905	4010312109489	84,30 €	9-4
EUD12DK/800W-UC	Universal dimmer switch with rotary knob	21100810	4010312109656	79,80 €	9-6
EUD12F	Universal dimmer switch	21100830	4010312108086	86,40 €	9-5
EUD12NPN-UC	Universal dimmer switch	21100806	4010312107843	70,30 €	9-3
EUD61M-UC	Multifunction universal dimmer switch	61100903	4010312107973	61,10 €	9-17
EUD61NP-230V	Universal dimmer switch	61100830	4010312108062	71,20 €	9-13
EUD61NPL-230V	Universal dimmer switch, without N connection, especially for LED	61100832	4010312109618	68,40 €	9-14
EUD61NPN-230V	Universal dimmer switch	61100802	4010312109564	68,70 €	9-16
EUD61NPN-UC	Universal dimmer switch	61100801	4010312107874	67,40 €	9-15
EUD62NPN-IP/110-240V	Universal dimmer switch IP	30062002	4010312324691	82,10 €	8-4
EVA12-32A	Single-phase energy meter with energy consumption indicator	28032411	4010312500828	75,10 €	10-24
Exchange set lightning on USB-C	USB-C cable for exchanging lightning on USB-C for OnWall	30000007	4010312323878	115,70 €	6-10
F					
FIT55E-am	Wireless 1-way pushbutton in E-Design55	30055722	4010312323687	49,40 €	5-3
FIT55E-pg	Wireless 1-way pushbutton in E-Design55	30055703	4010312325513	49,40 €	5-3
FIT55E-pm	Wireless 1-way pushbutton in E-Design55	30055713	4010312325520	49,40 €	5-3
FIT55E-wg	Wireless 1-way pushbutton in E-Design55	30055725	4010312321096	49,40 €	5-3
FIT55E-wg/rot	Wireless 1-way pushbutton in E-Design55 for calling systems	30055810	4010312328019	64,10 €	5-5
FIT80-am	Wireless 1-way pushbutton without battery and wire	30000453	4010312324257	50,80 €	5-32
FIT80-wg	Wireless 1-way pushbutton without battery and wire	30000451	4010312324059	50,80 €	5-32
F2L14	2-speed fan relay	30014067	4010312316160	66,40 €	1-23
F2T55E-am	Wireless 2-way pushbutton in E-Design55	30055718	4010312322048	53,90 €	5-3
F2T55E-pg	Wireless 2-way pushbutton in E-Design55	30055702	4010312325506	53,90 €	5-3
F2T55E-pm	Wireless 2-way pushbutton in E-Design55	30055727	4010312325537	53,90 €	5-3
F2T55E-wg	Wireless 2-way pushbutton in E-Design55	30055715	4010312319918	53,90 €	5-3
F2T55EOR-am	Wireless 2-way pushbutton in E-Design55	30056718	4010312327746	51,20 €	5-3
F2T55EOR-pg	Wireless 2-way pushbutton in E-Design55	30056702	4010312327753	51,20 €	5-3
F2T55EOR-pm	Wireless 2-way pushbutton in E-Design55	30056727	4010312327760	51,20 €	5-3
F2T55EOR-wg	Wireless 2-way pushbutton in E-Design55	30056715	4010312327722	51,20 €	5-3
F2T55EB-am	Wireless 2-way pushbutton with batteries in E-Design55	30055676	4010312325438	70,80 €	5-4
F2T55EB-pg	Wireless 2-way pushbutton with batteries in E-Design55	30055672	4010312325414	70,80 €	5-4
F2T55EB-pm	Wireless 2-way pushbutton with batteries in E-Design55	30055673	4010312325421	70,80 €	5-4
F2T55EB-wg	Wireless 2-way pushbutton with batteries in E-Design55	30055675	4010312321171	70,80 €	5-4
F22T55E-am	Wireless 2-way central control pushbutton in E-Design55	30055442	4010312325841	59,60 €	5-3
F22T55E-pg	Wireless 2-way central control pushbutton in E-Design55	30055443	4010312325858	59,60 €	5-3
F22T55E-pm	Wireless 2-way central control pushbutton in E-Design55	30055445	4010312325865	59,60 €	5-3
F22T55E-wg	Wireless 2-way central control pushbutton in E-Design55	30055447	4010312319994	59,60 €	5-3
F3Z14D	Bus meter collector	30014055	4010312501528	60,90 €	1-34, 10-15
F4HK14	4-channel heating/cooling relay	30014010	4010312314982	62,90 €	1-25
F4PT55E-	4-channel heating/cooling relay	30055432	4010312324653	61,40 €	5-4
F4SR14-LED	4-channel impulse switch	30014076	4010312317006	76,30 €	1-9
F4T55E-am	Wireless 4-way pushbutton in E-Design55	30055708	4010312322062	55,80 €	5-3
F4T55E-pg	Wireless 4-way pushbutton in E-Design55	30055733	4010312325551	55,80 €	5-3
F4T55E-pm	Wireless 4-way pushbutton in E-Design55	30055734	4010312325568	55,80 €	5-3
F4T55E-wg	Wireless 4-way pushbutton in E-Design55	30055705	4010312319833	55,80 €	5-3
F4T55EOR-am	Wireless 4-way pushbutton in E-Design55	30056708	4010312327777	51,20 €	5-3
F4T55EOR-pg	Wireless 4-way pushbutton in E-Design55	30056733	4010312327784	51,20 €	5-3
F4T55EOR-pm	Wireless 4-way pushbutton in E-Design55	30056734	4010312327852	51,20 €	5-3
F4T55EOR-wg	Wireless 4-way pushbutton in E-Design55	30056705	4010312327739	51,20 €	5-3

INDEX

TYPE	MEANING	ART. NO.	EAN	LIST PRICE	CHAPTER
F4T55EB-am	Wireless 4-way pushbutton in E-Design55	30055688	4010312323816	72,80 €	5-4
F4T55EB-pg	Wireless 4-way pushbutton in E-Design55	30055682	4010312325445	72,80 €	5-4
F4T55EB-pm	Wireless 4-way pushbutton in E-Design55	30055683	4010312325452	72,80 €	5-4
F4T55EB-wg	Wireless 4-way pushbutton in E-Design55	30055685	4010312320570	72,80 €	5-4
F4USM61B	Wireless 4-way universal transmitter module	30000301	4010312321386	72,20 €	3-35
F6T55EB-am	Wireless 6-way pushbutton in E-Design55	30055696	4010312325490	83,60 €	5-5
F6T55EB-pg	Wireless 6-way pushbutton in E-Design55	30055692	4010312325469	83,60 €	5-5
F6T55EB-pm	Wireless 6-way pushbutton in E-Design55	30055693	4010312325476	83,60 €	5-5
F6T55EB-wg	Wireless 6-way pushbutton in E-Design55	30055695	4010312325483	83,60 €	5-5
F6T55EB-Keypad-am	Wireless 6-way pushbutton as keypad, laser engraved, in E-Design55	30055149	4010312326510	87,10 €	5-5
F6T55EB-Keypad-pg	Wireless 6-way pushbutton as keypad, laser engraved, in E-Design55	30055150	4010312326527	87,10 €	5-5
F6T55EB-Keypad-pm	Wireless 6-way pushbutton as keypad, laser engraved, in E-Design55	30055151	4010312326534	87,10 €	5-5
F6T55EB-Keypad-wg	Wireless 6-way pushbutton as keypad, laser engraved, in E-Design55	30055148	4010312326503	87,10 €	5-5
FA200	High-performance receive antenna	30000551	4010312303306	81,00 €	1-4
FA250	Wireless antenna	30000550	4010312300244	31,70 €	1-4, 3-51
FA250-gw	Wireless antenna	30000553	4010312317051	31,70 €	1-4, 3-51
FABH130/230V-rw	Wireless outdoor motion/brightness sensor	30000466	4010312317617	149,20 €	5-34
FABH65S-wg	Wireless outdoor motion/brightness sensor	30065852	4010312315798	120,90 €	5-34
FAC55D/230V-wg	Wireless alarm controller with display	30000727	4010312319710	104,00 €	3-60
FAE14LPR	Wireless actuator for single room control heating/cooling	30014030	4010312314234	59,60 €	1-42
FAE14SSR	Wireless actuator for single room control heating/cooling, noiseless	30014029	4010312314173	67,90 €	1-41
FAG55E-am	Wireless antenna, anthrazite mat	30055144	4010312326114	48,80 €	1-4, 5-9
FAG55E-pg	Wireless antenna, polarwhite glossy	30055145	4010312326121	48,80 €	1-4, 5-9
FAG55E-pm	Wireless antenna, polarwhite mat	30055146	4010312326138	48,80 €	1-4, 5-9
FAG55E-wg	Wireless antenna, pure white glossy	30055147	4010312326145	48,80 €	1-4, 5-9
FAM14	Wireless antenna module	30014000	4010312313695	123,40 €	1-3
FARP60-230V	Wireless outdoor repeater	30000353	4010312310137	84,50 €	3-51
FAS260SA	Wireless outdoor siren	30000041	4010312320075	130,50 €	3-62
FASM60-UC	Wireless outdoor transmitter module	30000456	4010312311998	74,50 €	5-35
FASSA-230V	Wireless outdoor socket switch actuator	30100011	4010312323984	112,00 €	3-54
FASWZ-16A	Wireless outdoor socket energy meter	30100015	4010312324509	114,90 €	3-54, 10-25
FAV10	Wireless antenna extension 10m	30000554	4010312302903	52,00 €	1-4
FAV5	Wireless antenna extension 5m	30000552	4010312302897	41,50 €	1-4
FB55EB-am	Wireless motion sensor in E-Design55	30055513	4010312322321	89,10 €	5-8
FB55EB-pg	Wireless motion sensor in E-Design55	30055514	4010312325902	89,10 €	5-8
FB55EB-pm	Wireless motion sensor in E-Design55	30055515	4010312325919	89,10 €	5-8
FB55EB-wg	Wireless motion sensor in E-Design55	30055512	4010312321003	89,10 €	5-8
FBA14	RS485 bus coupler	30014018	4010312313862	33,40 €	1-39
FBH55ESB-am	Wireless motion/brightness sensor in E-Design55	30055516	4010312325926	106,80 €	5-8
FBH55ESB-pg	Wireless motion/brightness sensor in E-Design55	30055517	4010312325933	106,80 €	5-8
FBH55ESB-pm	Wireless motion/brightness sensor in E-Design55	30055518	4010312325940	106,80 €	5-8
FBH55ESB-wg	Wireless motion/brightness sensor in E-Design55	30055519	4010312327708	106,80 €	5-8
FC02TS-wg	Wireless CO2 desktop sensor with temperature+humidity sensor	30065278	4010312324004	246,20 €	5-32
FD62NP-230V	Wireless universal dimming actuator without N terminal	30100537	4010312319468	77,10 €	3-5
FD62NPN-230V	Wireless universal dimming actuator	30100535	4010312319086	75,60 €	3-5
FD614	RS485 bus DALI gateway	30014047	4010312316085	95,60 €	1-17,6-8, 7-2
FDG62-230V	Wireless DALI gateway	30100868	4010312320921	79,80 €	3-6, 7-3
FDG71L-230V	Wireless DALI gateway	30100867	4010312317556	140,60 €	3-44, 7-4
FDH62NP-230V+FTKB-wg	Wireless extractor hoods control with window/door contact	30100036	4010312319826	119,70 €	3-10
FEM	Wireless receiver antenna module	30014016	4010312313848	95,40 €	1-45
FEM65-wg	Wireless receiver antenna module	30065016	4010312315934	95,70 €	1-45
FF8-al/anso	Wireless remote control	30000769	4010312303391	121,30 €	5-31
FFD-al/anso	Wireless remote control	30000773	4010312313541	132,70 €	5-31
FFG7B-al	Wireless window handle sensor	30000460	4010312322031	76,60 €	5-37
FFG7B-am	Wireless window handle sensor	30000468	4010312322291	76,60 €	5-37
FFG7B-rw	Wireless window handle sensor	30000443	4010312318638	76,60 €	5-37
FFGB-hg	Wireless window handle sensor	30000473	4010312322246	192,10 €	5-38
FFKB-am	Wireless window handle sensor	30000425	4010312323663	73,10 €	5-36
FFKB-wg	Wireless window handle sensor	30000423	4010312321102	73,10 €	5-36
FFT55EB-am	Wireless humidity temperature sensor in E-Design55	30055476	4010312325872	75,00 €	5-7
FFT55EB-pg	Wireless humidity temperature sensor in E-Design55	30055477	4010312325889	75,00 €	5-7
FFT55EB-pm	Wireless humidity temperature sensor in E-Design55	30055478	4010312325896	75,00 €	5-7
FFT55EB-wg	Wireless humidity temperature sensor in E-Design55	30055475	4010312321010	75,00 €	5-7
FFT60SB	Wireless humidity temperature sensor	30000461	4010312320945	84,70 €	5-33
FFTE-rw	Wireless window touch contact	30000450	4010312319024	64,20 €	3-36
FGM	Wireless gong module	30000040	4010312303290	82,00 €	3-60
FGTZ-230V	Wireless garage door adapter	30000379	4010312324462	88,90 €	3-58
FGW14	RS485 bus gateway	30014017	4010312313855	68,50 €	1-35
FGW14-USB	RS485 bus gateway with USB connection	30014049	4010312316054	64,90 €	1-37
FGW14W-IP	RS485 bus energy meters MQTT Gateway via WLAN; MQTT and REST-API	30014041	4010312327876	92,40 €	1-36, 6-7

TYPE	MEANING	ART. NO.	EAN	LIST PRICE	CHAPTER
FGW14WL-IP	RS485 Bus energy meters MQTT Gateway via WLAN or LAN; MQTT and REST-API	30014051	4010312327623	106,50 €	1-36, 6-7
FHS8-wg	Wireless handheld transmitter with 2 double rockers	30000205	4010312300947	99,90 €	5-30
FHS8B-wg	Wireless handheld transmitter with 2 double rockers and battery	30000206	4010312328194	99,90 €	5-30
FHD60SB-wg	Wireless brightness/twilight sensor	30000462	4010312320952	83,70 €	5-34
FHK14	Wireless heating/cooling relay	30014014	4010312313824	58,10 €	1-24
FHK61-230V	Wireless actuator heating/cooling relay	30100045	4010312302309	94,20 €	3-28
FHK61SSR-230V	Wireless actuator heating/cooling relay with solid state relay	30100034	4010312314906	95,20 €	3-30
FHK61U-230V	Wireless actuator heating relay for valves+heat circulating pumps	30100050	4010312315118	93,80 €	3-29
FHM175	HF ground for FA250	30000555	4010312313121	91,80 €	1-4
FHMB-rw	Wireless heat detector	30000056	4010312321034	166,80 €	5-36
FHS2-al/anso	Wireless heat detector	30000771	4010312320303	66,20 €	5-29
FHS4-al/anso	Wireless heat detector	30000770	4010312320297	69,00 €	5-30
FIUS55E-am	Wireless indoor UP signal generator anthracite mat in E-Design55	30055069	4010312326053	86,40 €	3-61
FIUS55E-pg	Wireless indoor UP signal generator polar white glossy in E-Design55	30055070	4010312326060	86,40 €	3-61
FIUS55E-pm	Wireless indoor UP signal generator polar white mat in E-Design55	30055071	4010312326077	86,40 €	3-61
FIUS55E-wg	Wireless indoor UP signal generator pure white glossy in E-Design55	30055068	4010312320990	86,40 €	3-61
FIW-USB	Wireless infrared converter with USB port	30000387	4010312311158	99,20 €	5-39
FJ62/12-36V DC	Wireless shading element and roller shutter actuator	30200540	4010312319406	72,40 €	3-7
FJ62NP-230V	Wireless shading element and roller shutter actuator	30200535	4010312319390	66,30 €	3-8
FK	Window contact	20000086	4010312903001	32,80 €	12-15
FKD-am	Wireless bell pushbutton	30000408	4010312324066	59,70 €	5-32
FKD-wg	Wireless bell pushbutton	30000420	4010312319475	59,70 €	5-32
FKF65-wg	Wireless key card switch	30065545	4010312316115	65,60 €	5-31
FKLD61	Wireless actuator constant current LED dimmer switch	30100836	4010312314357	106,10 €	3-22
FKS-SV	Wireless small actuator	30000413	4010312319857	185,40 €	5-40
FL62-230V	Wireless light actuator	30100532	4010312319383	65,80 €	3-4
FL62NP-230V	Wireless light actuator	30100530	4010312319109	65,80 €	3-4
FLC61NP-230V	Wireless actuator light controller	30100040	4010312312032	94,30 €	3-19
FLD61	Wireless actuator PWM LED dimmer switch	30100837	4010312315255	100,10 €	3-23
FLGTF55E/230V-am	Wireless air quality+temperature+humidity sensor in E-Design55	30055521	4010312325957	105,10 €	5-8
FLGTF55E/230V-pg	Wireless air quality+temperature+humidity sensor in E-Design55	30055522	4010312325964	105,10 €	5-8
FLGTF55E/230V-pm	Wireless air quality+temperature+humidity sensor in E-Design55	30055523	4010312325971	105,10 €	5-8
FLGTF55E/230V-wg	Wireless air quality+temperature+humidity sensor in E-Design55	30055520	4010312321058	105,10 €	5-8
FLT58-am	Wireless air quality desktop sensor + temperature and humidity	30058520	4010312323922	108,00 €	5-32
FLUD14	Capacity enhancer for universal dimmer switch FUD14/800W	30014007	4010312313763	68,00 €	1-14, 1-15
FMHIW-anso	Wireless 1-way mini handheld transmitter waterproof	30000467	4010312322178	62,70 €	5-28
FMHIW-wg/rot	Wireless 1-way mini handheld transmitter for calling systems, with carry strap	30000465	4010312323847	66,70 €	5-28
FMH2-an	Wireless mini handheld transmitter	30000757	4010312303498	63,20 €	5-28
FMH2-rw	Wireless mini handheld transmitter	30000752	4010312303467	63,20 €	5-28
FMH2-sz	Wireless mini handheld transmitter	30000754	4010312303474	63,20 €	5-28
FMH2-wg	Wireless mini handheld transmitter	30000755	4010312303461	63,20 €	5-28
FMH2-ws	Wireless mini handheld transmitter	30000750	4010312303450	63,20 €	5-28
FMH2S-an	Wireless mini handheld transmitter for key ring	30000087	4010312303405	63,20 €	5-29
FMH2S-rw	Wireless mini handheld transmitter for key ring	30000082	4010312303375	63,20 €	5-29
FMH2S-sz	Wireless mini handheld transmitter for key ring	30000084	4010312303382	63,20 €	5-29
FMH2S-wg	Wireless mini handheld transmitter for key ring	30000085	4010312303399	63,20 €	5-29
FMH2S-ws	Wireless mini handheld transmitter for key ring	30000080	4010312303368	63,20 €	5-29
FMH4-an	Wireless mini handheld transmitter with double rocker	30000237	4010312301043	66,50 €	5-29
FMH4-rw	Wireless mini handheld transmitter with double rocker	30000232	4010312301036	66,50 €	5-29
FMH4-sz	Wireless mini handheld transmitter with double rocker	30000234	4010312301012	66,50 €	5-29
FMH4-wg	Wireless mini handheld transmitter with double rocker	30000235	4010312301067	66,50 €	5-29
FMH4-ws	Wireless mini handheld transmitter with double rocker	30000230	4010312301029	66,50 €	5-29
FMH4S-an	Wireless mini handheld transmitter with double rocker for key ring	30000097	4010312301579	66,50 €	5-29
FMH4S-rw	Wireless mini handheld transmitter with double rocker for key ring	30000092	4010312301562	66,50 €	5-29
FMH4S-sz	Wireless mini handheld transmitter with double rocker for key ring	30000094	4010312301555	66,50 €	5-29
FMH4S-wg	Wireless mini handheld transmitter with double rocker for key ring	30000095	4010312301586	66,50 €	5-29
FMH4S-ws	Wireless mini handheld transmitter with double rocker for key ring	30000090	4010312301371	66,50 €	5-29
FMH8-ag	Wireless mini handheld transmitter, 8 signals	30000454	4010312321331	104,50 €	5-30
FMH8-al/anso	Wireless mini handheld transmitter, 8 signals	30000419	4010312313282	107,40 €	5-30
FMH8-wg	Wireless mini handheld transmitter, 8 signals	30000455	4010312321348	104,50 €	5-30
FMS14	Multifunction impulse switch with integrated relay function	30014003	4010312313725	57,50 €	1-11
FMS55ESB-am	Wireless mini multi sensor in E-Design55	30055763	4010312326251	115,40 €	5-8
FMS55ESB-pg	Wireless mini multi sensor in E-Design55	30055764	4010312326268	115,40 €	5-8
FMS55ESB-pm	Wireless mini multi sensor in E-Design55	30055765	4010312326275	115,40 €	5-8
FMS55ESB-wg	Wireless mini multi sensor in E-Design55	30055561	4010312321799	115,40 €	5-8
FMS61NP-230V	Wireless actuator multifunction impulse switch	30200330	4010312300268	94,60 €	3-18
FMSR14	Multifunction sensor relay	30014028	4010312314111	64,00 €	1-28
FMT55/2-rw	Wireless mini pushbuttons without battery or wire	30000192	4010312312469	54,80 €	5-25
FMT55/2-wg	Wireless mini pushbuttons without battery or wire	30000195	4010312312483	54,80 €	5-25
FMT55/4-rw	Wireless mini pushbuttons without battery or wire with double rocker	30000262	4010312312544	57,20 €	5-25

INDEX

TYPE	MEANING	ART. NO.	EAN	LIST PRICE	CHAPTER
FMT55/4-wg	Wireless mini pushbuttons without battery or wire with double rocker	30000265	4010312312568	57,20 €	5-25
FMZ14	Multifunction time relay	30014009	4010312313787	55,40 €	1-21
FMZ61-230V	Multifunction time relay	30100230	4010312302293	89,10 €	3-27
FPE-1	Wireless position switch with energy generator	30000398	4010312315552	70,00 €	5-39
FPLG14	Wireless Powerline gateway	30014070	4010312316771	100,00 €	4-2
FPLT14	Wireless Powerline tunnel gateway	30014078	4010312317723	100,00 €	4-2
FPP12	Wireless Powernet phase coupler	30000051	4010312311769	34,00 €	2-4
FR12-230V	Mains disconnection relay	22100231	4010312203255	82,80 €	14-3
FR61-230V	Mains disconnection relay	61100530	4010312203477	76,10 €	14-4
FR62-230V	Wireless relay actuator	30100540	4010312320327	65,80 €	3-3
FR62NP-230V	Wireless relay actuator	30100543	4010312320464	65,80 €	3-3
FRGBW14	RS485 bus wireless actuator PWM dimmer switch for LED	30014068	4010312324097	110,60 €	1-18
FRGBW71L	PWM dimmer switch for LED	30400837	4010312316450	114,50 €	3-45
FRM60M10	Wireless tubular motor	30000048	4010312321249	266,30 €	3-63
FRM60M20	Wireless tubular motor	30000049	4010312321256	304,30 €	3-63
FRP14	Wireless repeater	30014019	4010312313879	90,80 €	1-46
FRP61-230V	Wireless repeater	30000350	4010312300251	69,30 €	3-31
FRP62-230V	Wireless repeater	30000534	4010312320310	63,70 €	3-9
FRP65/230V-wg	Wireless repeater in E-Design65	30085350	4010312315927	83,70 €	3-52
FRP70-230V	Wireless repeater	30000352	4010312306482	99,90 €	3-51
FRWB-rw	Wireless smoke alarm	30000054	4010312321027	158,40 €	5-35
FS55E-am	Wireless switch without battery and wire in E-Design55	30000602	4010312324431	53,90 €	5-4
FS55E-pg	Wireless switch without battery and wire in E-Design55	30055811	4010312326480	53,90 €	5-4
FS55E-pm	Wireless switch without battery and wire in E-Design55	30055812	4010312326487	53,90 €	5-4
FS55E-wg	Wireless switch without battery and wire in E-Design55	30000601	4010312324424	53,90 €	5-4
FSAF-gr	Cover foil grey	30999002	4010312908136	3,90 €	5-19, 5-22
FSB14	Wireless actuator for shading elements and roller shutters	30014004	4010312313732	64,90 €	1-19
FSB14/12-24VDC	Wireless actuator for shading elements and roller shutters	30014079	4010312326701	61,00 €	1-20
FSB61-230V	Wireless actuator for shading elements and roller shutters	30200432	4010312317235	94,90 €	3-24
FSB61NP-230V	Wireless actuator for shading elements and roller shutters	30200430	4010312300213	92,10 €	3-25
FSB71-230V	Wireless actuator for shading elements and roller shutters	30200831	4010312316306	95,50 €	3-47
FSB71-2x-230V	Wireless actuator for shading elements 2 channels	30400868	4010312316290	119,60 €	3-48
FSDG14	Energy meter data gateway	30014066	4010312316146	59,60 €	1-33, 10-16
FSG14/1-10V	RS485 bus dimmer switch controller for electronic ballast 1-10V	30014008	4010312313770	69,90 €	1-16
FSG71/1-10V	Wireless actuator dimmer switch controller	30100841	4010312316283	115,40 €	3-43
FSHA-230V	Wireless actuator wireless socket heating actuator	30100008	4010312318997	119,70 €	3-57
FSLA-230V	Wireless light actuator adapter	30100020	4010312324141	84,60 €	3-53
FSM14-UC	Wireless 4-fold transmitter module	30014048	4010312316078	75,20 €	1-47
FSM60B	Wireless transmitter module w/ batteries for water sensor and pushbutton	30000459	4010312316092	76,90 €	5-35
FSM61-UC	Wireless 2-fold transmitter module	30000300	4010312300152	66,20 €	3-35
FSMTB	Power supply unit	30000604	4010312327654	71,10 €	5-39
FSNT14-12V/12W	RS485 bus actuator 2-channel impulse switch	30014062	4010312315095	55,60 €	1-48, 2-7
FSR14-2x	RS485 bus actuator 4-channel impulse switch	30014002	4010312313718	65,40 €	1-7
FSR14-4x	RRS485 bus actuator noiseless 2-channel impulse switch	30014001	4010312313701	65,40 €	1-6
FSR14M-2x	Wireless actuator impulse switch with integr. relay function	30014039	4010312327692	95,50 €	1-8
FSR14SSR	Wireless actuator impulse switch with integr. relay function	30014020	4010312313893	66,00 €	1-10
FSR61/8-24V UC	Wireless actuator noiseless impulse switch w/ integr. relay function	30100004	4010312301357	90,00 €	3-14
FSR61-230V	Wireless actuator impulse switch w/ integr. relay function	30100005	4010312301531	90,00 €	3-15
FSR61G-230V	Wireless actuator noiseless impulse switch w/ integr. relay function	30100029	4010312313886	93,80 €	3-16
FSR61LN-230V	Wireless actuator impulse switch with integr. relay function for bipolar switching of L and N	30200331	4010312313190	92,30 €	3-17
FSR61NP-230V	Wireless actuator impulse switch with integr. relay function	30100030	4010312300190	92,30 €	3-13
FSR70S-230V	Wireless impulse switch with integr. relay function as cord switch	30100862	4010312301487	92,20 €	3-50
FSR71-2x-230V	Wireless 2-channel impulse switch with integr. relay function	30200868	4010312316252	118,90 €	3-39
FSR71NP-230V	Wireless impulse switch with integr. relay function	30100865	4010312316221	95,50 €	3-37
FSR71NP-2x-230V	Wireless 2-channel impulse switch with integr. relay function	30200865	4010312316245	120,30 €	3-38
FSR71NP-4x-230V	Wireless 4-channel impulse switch with integr. relay function	30400865	4010312316269	122,50 €	3-40
FSRP-230V	Wireless socket repeater	30000359	4010312314999	84,30 €	3-58
FSS12-12V DC	Wireless energy meter transmitter module	30100600	4010312301944	112,10 €	10-23
FSSA-230V	Wireless socket switching actuator	30100001	4010312314562	113,80 €	3-53
FSSG-230V	Wireless signal generator adapter	30000358	4010312323885	101,90 €	3-61
FSU14	RS485 bus display timer	30014015	4010312313831	64,00 €	1-26
FSU55ED/230V-am	Wireless timer with display in E-Design55	30055806	4010312326442	99,40 €	5-9
FSU55ED/230V-pg	Wireless timer with display in E-Design55	30055807	4010312326459	99,40 €	5-9
FSU55ED/230V-pm	Wireless timer with display in E-Design55	30055808	4010312326466	99,40 €	5-9
FSU55ED/230V-wg	Wireless timer with display in E-Design55	30055809	4010312326473	99,40 €	5-9
FSUD-230V	Wireless actuator socket universal dimmer switch	30100002	4010312314791	140,20 €	3-56
FSVA-230V-10A	Wireless actuator socket switching actuator with current measurement	30100003	4010312314555	121,50 €	3-55, 10-26
FT4B-cr	Wireless pushbutton Niko Belgium	30000229	4010312312995	62,00 €	5-23
FT4B-na	Wireless pushbutton Niko Belgium	30000240	4010312314180	62,00 €	5-23

TYPE	MEANING	ART. NO.	EAN	LIST PRICE	CHAPTER
FT4B-nw	Wireless pushbutton Niko Belgium	30000221	4010312312902	62,00 €	5-23
FT4Bl-an	Wireless pushbutton Bticino	30000245	4010312319758	62,00 €	5-23
FT4Bl-ww	Wireless pushbutton Bticino	30000246	4010312319765	62,00 €	5-23
FT4BL-lw	Wireless pushbutton Legrand Belgium	30000241	4010312314197	62,00 €	5-23
FT4CH-hg	Wireless pushbutton Swiss Design with rocker and double rocker	30000223	4010312300985	62,00 €	5-24
FT4CH-sz	Wireless pushbutton Swiss Design with rocker and double rocker	30000224	4010312300992	62,00 €	5-24
FT4CH-w	Wireless pushbutton Swiss Design with rocker and double rocker	30000222	4010312300978	62,00 €	5-24
FT4CH+2P-w	2P- wireless pushbutton Feller Swiss, laser engraved	30001222	4010312312001	68,90 €	5-24
FT4F-am	Wireless flat pushbutton without battery or wire	30000708	4010312324455	68,30 €	5-26
FT4F-pg	Wireless flat pushbutton without battery or wire	30000706	4010312327593	59,80 €	5-26
FT4F-pm	Wireless flat pushbutton without battery or wire	30000709	4010312327609	59,80 €	5-26
FT4F-rw	Wireless flat pushbutton without battery or wire	30000702	4010312302941	55,40 €	5-26
FT4F-wg	Wireless flat pushbutton without battery or wire	30000705	4010312302972	55,40 €	5-26
FT4S-ws	Wireless pushbutton Eljo Sweden	30000220	4010312303191	62,00 €	5-24
FT55-al	Wireless pushbutton 55 x 55 mm without battery or wire	30000591	4010312305829	65,90 €	5-20
FT55-an	Wireless pushbutton 55 x 55 mm without battery or wire	30000597	4010312305805	55,40 €	5-20
FT55-rw	Wireless pushbutton 55 x 55 mm without battery or wire	30000592	4010312305775	55,40 €	5-20
FT55-wg	Wireless pushbutton 55 x 55 mm without battery or wire	30000595	4010312305799	55,40 €	5-20
FT55-ws	Wireless pushbutton 55 x 55 mm without battery or wire	30000590	4010312308936	55,40 €	5-20
FT55EH-am	Friends of Hue wireless pushbutton in E-Design55	30055732	4010312325544	62,60 €	5-27
FT55EH-pg	Friends of Hue wireless pushbutton in E-Design55	30055719	4010312324714	62,60 €	5-27
FT55EH-pm	Friends of Hue wireless pushbutton in E-Design55	30055723	4010312324721	62,60 €	5-27
FT55EH-wg	Friends of Hue wireless pushbutton in E-Design55	30055717	4010312321690	62,60 €	5-27
FT55EL-ws	Wireless pushbutton Elko Finland	30000227	4010312316658	62,00 €	5-25
FT55ES-wg	Wireless pushbutton Exxact Sweden	30000244	4010312314227	62,00 €	5-24
FT55H-wg	Friends of Hue wireless pushbutton	30000596	4010312321706	66,30 €	5-27
FT55R-alpinweiß	Wireless 2- or 4-way pushbutton, without frame	30000226	4010312313992	62,00 €	5-23
FT55R-weiß	Wireless 2- or 4-way pushbutton, without frame	30000225	4010312313985	62,00 €	5-23
FT55RS-alpinweiß	Wireless pushbutton Jussi Sweden	30000243	4010312314210	62,00 €	5-25
FTAF55ED/230V-am	Wireless temperature controller Air+Floor in E-Design55	30055794	4010312326367	103,10 €	5-7
FTAF55ED/230V-pg	Wireless temperature controller Air+Floor in E-Design55	30055795	4010312326374	103,10 €	5-7
FTAF55ED/230V-pm	Wireless temperature controller Air+Floor in E-Design55	30055796	4010312326381	103,10 €	5-7
FTAF55ED/230V-wg	Wireless temperature controller Air+Floor in E-Design55	30055797	4010312326398	103,10 €	5-7
FTD14	Wireless telegram duplicator	30014057	4010312315705	92,60 €	1-38
FTE215	Wireless pushbutton insert EnOcean, encrypted, with mounting base and attachment frame	30999003	4010312318539	52,70 €	5-26
FTE215B	Wireless pushbutton insert with 4-channel pushbutton module, with battery	30999004	4010312328118	52,70 €	5-27
FTE215BLE	Wireless pushbutton insert, Bluetooth	30999005	4010312318553	62,20 €	5-27
FTFSB-am	Wireless temperature humidity sensor	30000475	4010312322406	83,90 €	5-33
FTFSB-wg	Wireless temperature humidity sensor	30000563	4010312320853	83,90 €	5-33
FTFB-am	Wireless temperature humidity sensor	30000429	4010312323670	77,40 €	5-33
FTFB-wg	Wireless temperature humidity sensor	30000559	4010312319147	77,40 €	5-33
FTK-ag	Wireless window/door contact	30000407	4010312305164	85,90 €	5-37
FTK-am	Wireless window/door contact	30000452	4010312321645	85,90 €	5-37
FTK-wg	Wireless window/door contact	30000421	4010312321638	85,90 €	5-37
FTKB-am	Wireless window/door contact with battery	30000474	4010312322352	73,40 €	5-37
FTKB-wg	Wireless window/door contact with battery	30000424	4010312321621	73,40 €	3-10, 5-37
FTKE-rw	Wireless window contact with energy generator	30000400	4010312315231	64,20 €	5-36
FTNI4	Wireless staircase lighting time delay switch	30014011	4010312313794	58,40 €	1-22
FTN6INP-230V	Wireless staircase lighting time delay switch	30100130	4010312300206	92,70 €	3-26
FTR55ESB-am	Wireless temperature controller in E-Design55	30055790	4010312326329	97,50 €	5-7
FTR55ESB-pg	Wireless temperature controller in E-Design55	30055791	4010312326336	97,50 €	5-7
FTR55ESB-pm	Wireless temperature controller in E-Design55	30055792	4010312326343	97,50 €	5-7
FTR55ESB-wg	Wireless temperature controller in E-Design55	30055793	4010312326350	97,50 €	5-7
FTR55EHB-am	Wireless temperature controller with hand wheel and battery in E-Design55	30055766	4010312326282	88,80 €	5-7
FTR55EHB-pg	Wireless temperature controller with hand wheel and battery in E-Design55	30055767	4010312326299	88,80 €	5-7
FTR55EHB-pm	Wireless temperature controller with hand wheel and battery in E-Design55	30055768	4010312326305	88,80 €	5-7
FTR55EHB-wg	Wireless temperature controller with hand wheel and battery in E-Design55	30055769	4010312326312	88,80 €	5-7
FTS14EM	Wireless input module	30014060	4010312315071	68,90 €	2-5
FTS14FA	Wireless input module	30014063	4010312315101	95,40 €	2-6
FTS14KS	FTS14 communication interface	30014065	4010312315651	91,50 €	2-4
FTS14TG	Pushbutton gateway	30014061	4010312315088	111,10 €	2-8
FTS61BTK	Bus pushbutton coupler	30014064	4010312315668	57,10 €	2-10, 5-10
FTS61BTK/8	Bus pushbutton coupler	30014075	4010312326015	93,50 €	2-11, 5-11
FTS61BTKL	Bus pushbutton coupler for feedback LED	30014074	4010312316801	62,50 €	2-10, 5-10
FTTB	Wireless pushbutton tracker	30100018	4010312321119	75,00 €	5-28
FTVW	Wireless pushbutton encryption rocker	30000016	4010312907030	2,10 €	5-19, 5-22
FUA12-230V	Wireless universal actuator with antenna	30000052	4010312316955	121,80 €	3-59
FUD14	RS485 bus universal dimmer switch	30014005	4010312313749	74,50 €	1-12
FUD14/800W	RS485 bus universal dimmer switch up to 800 W	30014006	4010312313756	100,30 €	1-13

INDEX

TYPE	MEANING	ART. NO.	EAN	LIST PRICE	CHAPTER
FUD61NP-230V	Wireless universal dimmer switch without N	30100830	4010312300183	105,10 €	3-20
FUD61NPN-230V	Wireless universal dimmer switch	30100835	4010312300299	109,20 €	3-21
FUD71-230V	Wireless universal dimmer switch	30100845	4010312316207	124,40 €	3-41
FUD71L/1200W-230V	Wireless universal dimmer switch	30100846	4010312316412	156,80 €	3-42
FUTH55ED/12-24V UC-am	Wireless thermo clock/hygrostat with display in E-Design55	30055798	4010312326404	106,60 €	5-6
FUTH55ED/12-24V UC-pg	Wireless thermo clock/hygrostat with display in E-Design55	30055799	4010312326421	106,60 €	5-6
FUTH55ED/12-24V UC-pm	Wireless thermo clock/hygrostat with display in E-Design55	30055800	4010312326428	106,60 €	5-6
FUTH55ED/12-24V UC-wg	Wireless thermo clock/hygrostat with display in E-Design55	30055801	4010312326435	106,60 €	5-6
FUTH55ED/230V-am	Wireless thermo clock/hygrostat with display in E-Design55	30055802	4010312326787	105,60 €	5-6
FUTH55ED/230V-pg	Wireless thermo clock/hygrostat with display in E-Design55	30055803	4010312326794	105,60 €	5-6
FUTH55ED/230V-pm	Wireless thermo clock/hygrostat with display in E-Design55	30055804	4010312326800	105,60 €	5-6
FUTH55ED/230V-wg	Wireless thermo clock/hygrostat with display in E-Design55	30055805	4010312326817	105,60 €	5-6
FWST	Wireless encryption plug	30000015	4010312907290	5,30 €	5-39
FWG14MS	Wireless weather data gateway	30014072	4010312316887	61,80 €	1-27
FWS60	Water sensor for FSM60B	30000463	4010312316108	33,10 €	5-34
FWS61-24V DC	Wireless weather data transmitter module	30000305	4010312301937	79,60 €	1-28, 3-36, 5-40
FWS81	Wireless water probe	30000409	4010312316061	162,80 €	5-35
FWWKW71L	Wireless actuator PWM dimmer switch for LED	30200837	4010312318928	114,60 €	3-46
FWZ12-65A	Wireless single-phase energy meter transmitter module	30000308	4010312311059	95,50 €	10-25
FWZ14-65A	Wireless single-phase energy meter transmitter module	30014050	4010312501511	82,10 €	1-29, 10-14
FZS65-wg	Wireless pull switch	30067545	4010312316139	96,90 €	5-31
G					
GBA14	Housings for operating instructions	30014100	4010312906422	5,30 €	1-49
GLE	Base load	70000008	4010312900970	7,20 €	14-4
H					
HDR-30-5	Switching power supply unit 5 V/15 W for MiniSafe2-REG	30000940	4010312318874	56,00 €	6-5
HP+BF	Mounting plate with mounting frame	30000356	4010312909119	5,70 €	5-26
I					
InWall-10-sz	In-wall docking station with charging function	30000003	4010312323809	394,20 €	6-10
IRT3	Infrared transmitter with 3 m cable and 3.5 mm jack plug	30000100	4010312328217	6,00 €	6-4, Z-7
K					
KM12	Auxiliary contact	20000030	4010312901243	17,10 €	18-3
KNX ENO 626	EnOcean KNX gateway	30000944	4010312318911	323,90 €	6-9
KNX ENO 636	EnOcean KNX gateway	30000948	4010312318904	481,20 €	6-9
KR09-12V UC	Coupling relay	22100705	4010312203415	44,60 €	12-9
KR09-230V	Coupling relay	22100730	4010312203378	41,10 €	12-9
KR09-24V UC	Coupling relay	22100706	4010312203385	41,10 €	12-9
KRW12DX-UC	Coupling relay	22100800	4010312206683	55,00 €	12-10
L					
LGI	Laser engraving individually, create new pictogram	30000980	4010312908310	12,20 €	5-41, 5-42
LRW12D-UC	Digital settable sensor relay	22400501	4010312206553	81,40 €	16-5
LS	Light sensor	20000080	4010312901267	34,20 €	16-3
LU012-230V	Capacity enhancer	21100805	4010312107867	73,80 €	9-7, 9-8
M					
MFSR12DX-230V	Multifunction current relay for two-way three-phase meters	22100530	4010312206836	104,10 €	10-4, 10-17
MFZ12-230V	Analogue settable multifunction time relay	23100530	4010312603147	61,80 €	13-3
MFZ12DBT-UC	Digital settable multifunction time relay with display and Bluetooth	23001003	4010312603284	101,10 €	13-5
MFZ12DDX-UC	Digital settable multifunction time relay	23001004	4010312603079	70,10 €	13-6
MFZ12DX-UC	Analogue settable multifunction time relay	23001005	4010312603086	69,80 €	13-4
MFZ12NP-230V+UC	Analogue settable multifunction time relay	23100001	4010312602935	62,50 €	13-7
MFZ12PMD-UC	Fully electronic multifunction time relay	23001006	4010312601099	88,10 €	9-10, 13-8
MFZ12DX-UC	Analogue settable multifunction time relay	61100604	4010312603055	59,50 €	13-9
MOD12D-UC	Digitally adjustable motor dimmer	21100906	4010312109526	84,40 €	9-9
MiniSafe2	Controller	30000075	4010312323939	315,10 €	6-4
MiniSafe2-REG	Controller for installation on DIN rail	30000076	4010312323946	425,30 €	6-5
MS	Multi sensor	20000084	4010312901731	309,20 €	1-27, 3-36, 5-40, 16-3
MSR12-UC	Multifunction sensor relay	22500501	4010312205327	100,20 €	16-4
MTR12-UC	Actuator motor isolating relay	22400601	4010312205211	74,20 €	16-7
MTR62-230V	Actuator motor isolating relay	61400603	4010312206829	58,70 €	16-9
mTronic	Wireless window multisensor in the rebate with battery	30000033	4010312324127	126,00 €	5-37
N					
NF2A	Mains filter up to 2A, 230 V/50 Hz	30000028	4010312324370	38,10 €	4-9
NFCS55E-am	NFC sensor in E-Design55	30055647	4010312325988	20,00 €	5-6
NFCS55E-pg	NFC sensor in E-Design55	30055648	4010312325995	20,00 €	5-6
NFCS55E-pm	NFC sensor in E-Design55	30055649	4010312326008	20,00 €	5-6
NFCS55E-wg	NFC sensor in E-Design55	30055646	4010312322130	20,00 €	5-6
NLZ12NP-230V+UC	Off-delay timer	23100704	4010312602911	59,60 €	15-11
NLZ61NP-UC	Off-delay timer	61100704	4010312603048	56,80 €	15-12
NR12-001-3x230V	Mains monitoring relay	22001330	4010312202524	61,20 €	14-7

TYPE	MEANING	ART. NO.	EAN	LIST PRICE	CHAPTER
NR12-002-3x230V	Mains monitoring relay	22002330	4010312202548	75,70 €	14-7
Q					
OnWall-al	On-wall docking station with charging function, natural aluminium	30000001	4010312323786	368,50 €	6-10
OnWall-sz	On-wall docking station with charging function, black anodized aluminium	30000002	4010312323793	368,50 €	6-10
OnWall/C-al	Universal wall docking station for all USB-C iPads, with charging function, natural aluminium	30000043	4010312328033	399,60 €	6-10
OnWall/C-sz	Universal wall docking station for all USB-C iPads, with charging function, black anodized aluminium	30000044	4010312328040	399,60 €	6-10
P					
P3K12-230V	Phase annunciator	24000899	4010312701065	43,90 €	14-9
P10	Wireless level meter	30000370	4010312317068	170,10 €	2-6
PCT14	PC tool for Series 14 and Series 71				1-5
PL-AMD10V	Decentralised dimmer actuator	31100006	4010312316726	122,80 €	4-6
PL-FGW	Powerline wireless gateway	31100010	4010312324110	150,60 €	4-3
PL-RPT	Powerline repeater	31000030	4010312324103	101,70 €	4-3
PL-SAMIL	Decentralised actuator with sensor input	31100001	4010312316665	113,30 €	4-4
PL-SAMILT	Decentralised TLZ actuator with sensor input	31100004	4010312316702	115,30 €	4-7
PL-SAM2	Decentralised Venetian blind actuator with sensor inputs	31100002	4010312316689	115,30 €	4-5
PL-SAM2L	Decentralised actuator with sensor inputs	31200001	4010312316672	115,30 €	4-4
PL-SAMDU	Decentralised universal dimmer actuator with sensor input	31100008	4010312316870	130,70 €	4-6
PL-SAMTEMP	Powerline temperature controller	31000010	4010312316733	217,30 €	4-8
PL-SMIL	Decentralised sensor input	31100007	4010312316740	109,20 €	4-7
PL-SM8	Decentralised 8-channel sensor input	31800001	4010312316719	115,30 €	4-8
PL-SW-PROF	Coupling element for Software SIENNA®-Professional	31000020	4010312316856	399,20 €	4-9
PTN12-230V	Test Pushbutton for emergency lighting with off-delay	23001802	4010312603215	64,50 €	13-13
R					
R-rw	Single frame for wireless pushbuttons	30000182	4010312902370	4,90 €	5-21
R-wg	Single frame for wireless pushbuttons	30000185	4010312902400	4,90 €	5-21
R12-020-230V	2-pole electromechanical switching relay	22020030	4010312201572	40,60 €	19-2
R12-100-12V	1-pole electromechanical switching relay	22100011	4010312200421	31,00 €	19-2
R12-100-12V DC	1-pole electromechanical switching relay	22100054	4010312200995	33,50 €	19-2
R12-100-230V	1-pole electromechanical switching relay	22100030	4010312200445	31,00 €	19-2
R12-100-24V	1-pole electromechanical switching relay	22100020	4010312200438	33,50 €	19-2
R12-100-24V DC	1-pole electromechanical switching relay	22100055	4010312201008	33,50 €	19-2
R12-100-8V	1-pole electromechanical switching relay	22100010	4010312200414	33,50 €	19-2
R12-110-12V	2-pole electromechanical switching relay	22110011	4010312200469	39,40 €	19-2
R12-110-12V DC	2-pole electromechanical switching relay	22110054	4010312201015	41,50 €	19-2
R12-110-230V	2-pole electromechanical switching relay	22110030	4010312200483	39,40 €	19-2
R12-110-24V	2-pole electromechanical switching relay	22110020	4010312200476	41,50 €	19-2
R12-110-24V DC	2-pole electromechanical switching relay	22110055	4010312201022	41,50 €	19-2
R12-110-8V	2-pole electromechanical switching relay	22110010	4010312200452	41,50 €	19-2
R12-200-12V	2-pole electromechanical switching relay	22200011	4010312200506	39,40 €	19-2
R12-200-12V DC	2-pole electromechanical switching relay	22200054	4010312201039	41,50 €	19-2
R12-200-230V	2-pole electromechanical switching relay	22200030	4010312200520	39,40 €	19-2
R12-200-24V	2-pole electromechanical switching relay	22200020	4010312200513	41,50 €	19-2
R12-200-24V DC	2-pole electromechanical switching relay	22200055	4010312201046	41,50 €	19-2
R12-200-8V	2-pole electromechanical switching relay	22200010	4010312200490	41,50 €	19-2
R12-220-230V	4-pole electromechanical switching relay	22220030	4010312200568	58,90 €	19-2
R12-310-230V	4-pole electromechanical switching relay	22310030	4010312200605	58,90 €	19-2
R12-400-230V	4-pole electromechanical switching relay	22400030	4010312200643	58,90 €	19-2
R1UE55-am	Single universal frame in E-Design55	30055788	4010312908747	3,80 €	5-17
R1UE55-pg	Single universal frame in E-Design55	30055782	4010312909188	3,80 €	5-17
R1UE55-pm	Single universal frame in E-Design55	30055783	4010312909195	3,80 €	5-17
R1UE55-wg	Single universal frame in E-Design55	30055785	4010312908341	3,80 €	5-17
R2UE55-am	Double universal frame in E-Design55	30055738	4010312908754	4,90 €	5-17
R2UE55-pg	Double universal frame in E-Design55	30055787	4010312909210	4,90 €	5-17
R2UE55-pm	Double universal frame in E-Design55	30055789	4010312909218	4,90 €	5-17
R2UE55-wg	Double universal frame in E-Design55	30055827	4010312908365	4,90 €	5-17
R3UE55-am	Triple universal frame in E-Design55	30055748	4010312908761	5,50 €	5-17
R3UE55-pg	Triple universal frame in E-Design55	30055749	4010312909126	5,50 €	5-17
R3UE55-pm	Triple universal frame in E-Design55	30055753	4010312909133	5,50 €	5-17
R3UE55-wg	Triple universal frame in E-Design55	30055828	4010312908358	5,50 €	5-17
R4UE55-am	4-way universal frame in E-Design55	30055758	4010312908778	6,80 €	5-17
R4UE55-pg	4-way universal frame in E-Design55	30055757	4010312909157	6,80 €	5-17
R4UE55-pm	4-way universal frame in E-Design55	30055755	4010312909140	6,80 €	5-17
R4UE55-wg	4-way universal frame in E-Design55	30055826	4010312908372	6,80 €	5-17
R5UE55-am	5-way universal frame in E-Design55	30055778	4010312908945	7,70 €	5-18
R5UE55-pg	5-way universal frame in E-Design55	30055759	4010312909164	7,70 €	5-18
R5UE55-pm	5-way universal frame in E-Design55	30055761	4010312909171	7,70 €	5-18
R5UE55-wg	5-way universal frame in E-Design55	30055775	4010312908938	7,70 €	5-18

INDEX

TYPE	MEANING	ART. NO.	EAN	LIST PRICE	CHAPTER
R81-002-230V	2-pole electromechanical switching relay	81002430	4010312203040	38,60 €	19-3
R91-100-12V	1-pole electromechanical switching relay	91100411	4010312203101	31,00 €	19-3
R91-100-230V	1-pole electromechanical switching relay	91100430	4010312203125	31,70 €	19-3
R91-100-8V	1-pole electromechanical switching relay	91100410	4010312203095	35,00 €	19-3
RC12-230V	Triple RC module	22000015	4010312201596	42,00 €	2-5
RLC-Glied	Range extension for B4T65/B4FT65 to FTS14TG	30000025	4010312907092	6,60 €	2-8
RS	Rain sensor	20000087	4010312206546	142,70 €	16-3
RTD	Direction pushbutton LED	60000015	4010312908273	4,20 €	16-8
RVZ12DX-UC	Analogue settable time relais with release delay	23001202	4010312603093	67,50 €	13-14
S					
S+D25	Screws + rawls	30999001	4010312906231	7,50 €	2-5
S09-12V	Electromechanical 16A impulse switch 1-pole	29100011	4010312104187	33,40 €	18-3
S09-230V	Electromechanical 16A impulse switch 1-pole	29100030	4010312104200	36,40 €	18-3
SI2-100-12V	1-pole electromechanical impulse switch	21100011	4010312100455	31,00 €	18-2
SI2-100-12V DC	1-pole electromechanical impulse switch	21100054	4010312101254	33,50 €	18-2
SI2-100-230V	1-pole electromechanical impulse switch	21100030	4010312100479	31,00 €	18-2
SI2-100-24V	1-pole electromechanical impulse switch	21100020	4010312100462	33,50 €	18-2
SI2-100-24V DC	1-pole electromechanical impulse switch	21100055	4010312101247	33,50 €	18-2
SI2-100-8V	1-pole electromechanical impulse switch	21100010	4010312100448	33,50 €	18-2
SI2-110-12V	2-pole electromechanical impulse switch	21110011	4010312100493	39,40 €	18-2
SI2-110-12V DC	2-pole electromechanical impulse switch	21110054	4010312101261	41,50 €	18-2
SI2-110-230V	2-pole electromechanical impulse switch	21110030	4010312100516	39,40 €	18-2
SI2-110-24V	2-pole electromechanical impulse switch	21110020	4010312100509	41,50 €	18-2
SI2-110-24V DC	2-pole electromechanical impulse switch	21110055	4010312101278	41,50 €	18-2
SI2-110-8V	2-pole electromechanical impulse switch	21110010	4010312100486	41,50 €	18-2
SI2-200-12V	2-pole electromechanical impulse switch	21200011	4010312100530	39,40 €	18-2
SI2-200-12V DC	2-pole electromechanical impulse switch	21200054	4010312101285	41,50 €	18-2
SI2-200-230V	2-pole electromechanical impulse switch	21200030	4010312100554	39,40 €	18-2
SI2-200-24V	2-pole electromechanical impulse switch	21200020	4010312100547	41,50 €	18-2
SI2-200-24V DC	2-pole electromechanical impulse switch	21200055	4010312101292	41,50 €	18-2
SI2-200-8V	2-pole electromechanical impulse switch	21200010	4010312100523	41,50 €	18-2
SI2-220-230V	4-pole electromechanical impulse switch	21220030	4010312100592	57,20 €	18-3
SI2-310-230V	4-pole electromechanical impulse switch	21310030	4010312100639	57,20 €	18-3
SI2-400-230V	4-pole electromechanical impulse switch	21400030	4010312104484	57,20 €	18-3
S2U12DBT-UC	2-channel timer with display and Bluetooth	23002903	4010312603307	113,10 €	13-17
S2U12DDX-UC	Digital settable timer with 2 channels	23200901	4010312603208	88,70 €	13-19
S81-002-230V	2-pole impulse switch	81002030	4010312103333	38,60 €	18-4
S91-100-12V	1-pole impulse switch	91100011	4010312103517	31,00 €	18-4
S91-100-230V	1-pole impulse switch	91100030	4010312103531	31,70 €	18-4
S91-100-8V	1-pole impulse switch	91100010	4010312103500	35,00 €	18-4
SAS-6TE	Bus bars 6 PU	30014024	4010312314050	15,30 €	1-43
SBR12-230V/240µF	Current-limiting relays capacitive	22100430	4010312205457	49,50 €	14-8
SBR61-230V/120µF	Current-limiting relays capacitive	61100330	4010312205464	54,80 €	14-8
SDS12/1-10V	1-10V control dimmer switch for electronic ballast units	21100800	4010312109403	71,30 €	9-11
SDS61/1-10V	1-10V control dimmer switch for electronic ballast units	61100800	4010312109496	65,50 €	9-19
SMW14	Bus jumper tool	30000017	4010312907023	1,50 €	1-49
SNT14-24V/24W	Switching power supply unit 24V DC	30014032	4010312314401	56,40 €	17-4
SNT14-24V/48W	Switching power supply unit 24V DC	30014033	4010312314418	84,40 €	17-4
S055	Table base	30000346	4010312908150	9,10 €	5-6
SS12-110-12V	2-pole electromechanical impulse switch	21110211	4010312101346	46,00 €	18-2
SS12-110-230V	2-pole electromechanical impulse switch	21110230	4010312101124	46,00 €	18-2
ST12-16A	Socket outlet	24100900	4010312700358	20,90 €	2-3
STS14	Set of jumpers	30014038	4010312314975	14,20 €	1-49
SUI2DBT/1+1-UC	2-channel timer with display and Bluetooth	23200902	4010312603277	103,70 €	13-16
SUDI2/1-10V	1-10V controller for universal dimmer switches	21100802	4010312108116	68,00 €	9-12
SV7x7x14	Pin extension	30000031	4010312908990	14,10 €	5-37
SWS55/DW-an	Splash-proof cover for FT55 for double rocker	30000057	4010312909065	12,20 €	5-22
SWS55/W-an	Splash-proof cover for FT55 for single rocker	30000055	4010312909034	12,20 €	5-22
T					
TAE55E/3-am	Cover for 3-socket TAE for E-Design55 frames	30055837	4010312909317	4,10 €	5-15
TAE55E/3-pg	Cover for 3-socket TAE for E-Design55 frames	30055839	4010312909324	4,10 €	5-15
TAE55E/3-pm	Cover for 3-socket TAE for E-Design55 frames	30055841	4010312909331	4,10 €	5-15
TAE55E/3-wg	Cover for 3-socket TAE for E-Design55 frames	30055836	4010312909072	4,10 €	5-15
TG12DX-UC	Analogue settable time relais with impulse	23001402	4010312603116	67,60 €	13-15
TLZ12-8	Staircase time switch	23100934	4010312401637	44,90 €	15-4
TLZ12-8plus	Staircase time switch	23100832	4010312401613	57,60 €	15-3
TLZ12-9	Staircase time switch	23100836	4010312401620	57,70 €	15-7
TLZ12D-plus	Digital settable staircase time switch	23100800	4010312401712	62,30 €	15-6
TLZ12G-230V+UC	Staircase time switch	23100831	4010312401460	63,80 €	15-5
TLZ12NP-230V	Staircase time switch	61100102	4010312400791	56,20 €	15-8

TYPE	MEANING	ART. NO.	EAN	LIST PRICE	CHAPTER
TLZ6INP-230V+UC	Staircase time switch	61100301	4010312400739	60,40 €	15-9
TSA02NC-230V	Thermal actuator	30014034	4010312314425	40,10 €	1-43
TSA02NC-24V	Thermal actuator	30014035	4010312314432	40,10 €	1-43
TV55E/2-am	2-hole cover for TV/RF socket for E-Design55 frames	30055830	4010312909256	4,10 €	5-15
TV55E/2-pg	2-hole cover for TV/RF socket for E-Design55 frames	30055831	4010312909263	4,10 €	5-15
TV55E/2-pm	2-hole cover for TV/RF socket for E-Design55 frames	30055832	4010312909270	4,10 €	5-15
TV55E/2-wg	2-hole cover for TV/RF socket for E-Design55 frames	30055838	4010312909102	4,10 €	5-15
TV55E/3-am	3-hole cover for TV/RF socket for E-Design55 frames	30055833	4010312909287	4,10 €	5-16
TV55E/3-pg	3-hole cover for TV/RF socket for E-Design55 frames	30055834	4010312909294	4,10 €	5-16
TV55E/3-pm	3-hole cover for TV/RF socket for E-Design55 frames	30055835	4010312909300	4,10 €	5-16
TV55E/3-wg	3-hole cover for TV/RF socket for E-Design55 frames	30055840	4010312909089	4,10 €	5-16
U					
U2RP	Universal double DIN rail mounting plate	30000018	4010312908860	6,00 €	Z-3
UAE55E/2-am	Cover for 2-hole UAE/IAE socket for E-Design55 frames	30055843	4010312909348	4,10 €	5-15
UAE55E/2-pg	Cover for 2-hole UAE/IAE socket for E-Design55 frames	30055844	4010312909355	4,10 €	5-15
UAE55E/2-pm	Cover for 2-hole UAE/IAE socket for E-Design55 frames	30055845	4010312909362	4,10 €	5-15
UAE55E/2-wg	Cover for 2-hole UAE/IAE socket for E-Design55 frames	30055842	4010312909096	4,10 €	5-15
UIB70	Universal installation box blue	30000011	4010312909058	12,80 €	Z-2
UIB70-rw	Universal installation box pure white	30000012	4010312909454	11,40 €	Z-2
USB-Kabel	USB extension cord, 2m long, TypA, ST/BU	30000020	4010312907702	15,90 €	1-37
W					
W2T55E-am	Rocker switch with double rocker in E-Design55	30055745	4010312326220	18,10 €	5-13
W2T55E-pg	Rocker switch with double rocker in E-Design55	30055752	4010312326237	18,10 €	5-13
W2T55E-pm	Rocker switch with double rocker in E-Design55	30055762	4010312326244	18,10 €	5-13
W2T55E-wg	Rocker switch with double rocker in E-Design55	30055712	4010312322376	18,10 €	5-13
W-FIT55E	Rocker for wireless pushbuttons E-Design55	30055949	4010312908969	8,00 €	5-41
W-F2T55E	Rocker for wireless pushbuttons E-Design55	30055966	4010312908396	8,00 €	5-41
W-F2T55E/10-am	10x Rocker for wireless pushbutton and wireless pushbutton with battery in E-Design55	30055971	4010312909522	15,00 €	5-41
W-F2T55E/10-pg	10x Rocker for wireless pushbutton and wireless pushbutton with battery in E-Design55	30055972	4010312909539	15,00 €	5-41
W-F2T55E/10-pm	10x Rocker for wireless pushbutton and wireless pushbutton with battery in E-Design55	30055973	4010312909546	15,00 €	5-41
W-F2T55E/10-wg	10x Rocker for wireless pushbutton and wireless pushbutton with battery in E-Design55	30055970	4010312909515	15,00 €	5-41
W-F2T55Eam+2P	Rocker for wireless pushbutton E-Design55, arrow top (up) and bottom (down)	30055969	4010312909423	8,00 €	5-41
W-F2T55Ewg+2P	Rocker for wireless pushbutton E-Design55, arrow top (up) and bottom (down)	30055967	4010312909416	8,00 €	5-41
W-FHS/FMH2	Rocker for wireless handheld transmitters and mini handheld transmitters	30000960	4010312906354	8,00 €	5-43
W-FMT55/2	Rocker for wireless mini pushbuttons	30000957	4010312906323	8,00 €	5-42
W-FT4CH	Rocker for wireless pushbuttons Swiss Design	30000959	4010312906347	8,00 €	5-42
W-FT4B-	Rocker for wireless pushbutton 45x45mm, Belgian design	30000965	4010312906408	8,00 €	5-42
W-FT4F-	Rocker for wireless flat pushbuttons	30000951	4010312906262	8,00 €	5-42
W-FT55	Rocker for wireless pushbuttons 55x55 mm	30000953	4010312906286	8,00 €	5-42
W-FT55R	Rocker for wireless pushbuttons 55x55 mm for Busch Reflex and Duro	30000967	4010312907047	8,00 €	5-43
W-WT/WS55	Rocker for rocker pushbutton and rocker switch 55x55 mm	30000975	4010312908112	8,00 €	5-43
WNT15-12VDC/24W	Wide-range power supply unit 12V DC	20000072	4010312401880	52,50 €	2-7, 2-17, 17-3
WNT15-24VDC/24W	Wide-range power supply unit 24V DC	20000073	4010312401910	52,50 €	17-3
WNT15-24VDC/48W	Wide-range power supply unit 24V DC	20000075	4010312401903	61,80 €	17-3
WNT15U/3,3-12V DC	Universal wide-range power supply unit	20000175	4010312401859	60,00 €	17-2
WNT61-12VDC/10W	Wide-range power supply unit 12V DC	6100264	4010312401934	47,20 €	17-5
WNT61-24VDC/10W	Wide-range power supply unit 24V DC	6100265	4010312401941	47,20 €	3-36, 5-40, 17-5
WP2	wibutler pro (2. Gen.) controller	30000077	4010312324608	410,30 €	6-6
WP50	WET.PROTECT e.nautic 50 ml spray	30000030	4010312907306	28,30 €	Z-5
WS	Wind sensor	20000082	4010312901281	79,70 €	16-3
WS55-rw	Rocker switch	30000632	4010312317464	12,10 €	5-20
WS55-wg	Rocker switch	30000635	4010312317433	12,10 €	5-20
WS55E-am	Rocker switch in E-Design55	30055735	4010312326169	14,50 €	5-13
WS55E-pg	Rocker switch in E-Design55	30055737	4010312326176	14,50 €	5-13
WS55E-pm	Rocker switch in E-Design55	30055739	4010312326183	14,50 €	5-13
WS55E-wg	Rocker switch in E-Design55	30055707	4010312322390	14,50 €	5-13
WSZ110DSS-16A MID	Mobile single-phase energy meter with MID	28016110	4010312501795	106,30 €	10-21
WSZ110DSS-16A+PRCD MID	Mobile single-phase energy meter personal protection intermediate switch PRCD, with MID	28016112	4010312501832	206,20 €	10-21
WSZ110CEE-16A MID	Mobile single-phase energy meter with MID	28016111	4010312501801	107,40 €	10-22
WSZ110CEE-16A+PRCD MID	Mobile single-phase energy meter personal protection intermediate switch PRCD, with MID	28016113	4010312501856	202,40 €	10-22
WSZ14DRS-32A MID	Single-phase energy meter, MID	28032715	4010312501900	75,00 €	1-29, 10-14
WSZ15D-32A MID	Single-phase energy meter, MID	28032015	4010312501627	67,00 €	10-18
WSZ15D-65A MID	Single-phase energy meter, MID	28065615	4010312501696	71,50 €	10-19
WSZ15DE-32A	Single-phase energy meter, without MID	28032615	4010312501702	59,00 €	10-18
WT55-rw	Rocker pushbutton	30000622	4010312317501	12,80 €	5-20

INDEX

TYPE	MEANING	ART. NO.	EAN	LIST PRICE	CHAPTER
WT55-wg	Rocker pushbutton	30000625	4010312317518	12,80 €	5-20
WT55E-am	Rocker pushbutton in E-Design55	30055742	4010312326190	15,20 €	5-13
WT55E-pg	Rocker pushbutton in E-Design55	30055743	4010312326206	15,20 €	5-13
WT55E-pm	Rocker pushbutton in E-Design55	30055744	4010312326213	15,20 €	5-13
WT55E-wg	Rocker pushbutton in E-Design55	30055709	4010312322383	15,20 €	5-13
WZR12-32A	Single-phase energy meter with reset, without MID	28032410	4010312501252	74,50 €	10-20
X					
XR12-100-230V	1-pole 25 A electromechanical installation contactor	22100930	4010312201206	37,20 €	19-4
XR12-110-230V	2-pole 25 A electromechanical installation contactor	22110930	4010312201251	45,50 €	19-4
XR12-200-230V	2-pole 25 A electromechanical installation contactor	22200930	4010312201305	45,50 €	19-4
XR12-220-230V	4-pole 25 A electromechanical installation contactor	22220930	4010312201473	62,00 €	19-4
XR12-310-230V	4-pole 25 A electromechanical installation contactor	22310930	4010312201428	62,00 €	19-4
XR12-400-230V	4-pole 25 A electromechanical installation contactor	22400930	4010312201374	62,00 €	19-4
XS12-100-230V	1-pole electromechanical 25 A impulse switch	21100930	4010312101513	36,10 €	18-5
XS12-110-230V	2-pole electromechanical 25 A impulse switch	21110930	4010312101551	43,90 €	18-5
XS12-200-230V	2-pole electromechanical 25 A impulse switch	21200930	4010312101605	43,90 €	18-5
XS12-220-230V	4-pole electromechanical 25 A impulse switch	21220930	4010312101759	60,20 €	18-5
XS12-310-230V	4-pole electromechanical 25 A impulse switch	21310930	4010312101704	60,20 €	18-5
XS12-400-230V	4-pole electromechanical 25 A impulse switch	21400930	4010312101650	60,20 €	18-5

GERMANY OFFICES AND SALES REPRESENTATIVES

Fellbach

Eltako Headquarter
Hofener Straße 54
70736 Fellbach

+49 711 943 500 00
info@eltako.de
kundenservice@eltako.de

Baden-Wuerttemberg (West)

Sales representative
Carsten Krampe

+49 173 3180392
krampe@eltako.de

Baden-Wuerttemberg (East)

Sales representative
Patrick Lutz

+49 162 2575122
lutz@eltako.de

Bavaria (North)

Sales representative
Mario Mehlaue

+49 174 8526825
mehlaue@eltako.de

Bavaria (South)

Elka Hugo Kirschke GmbH
82024 Taufkirchen

+89 309 040 90
+89 309 040 950
kirschke@eltako.de

Berlin/Brandenburg

Sales representative
Thomas Herzog

+49 173 3740412
herzog@eltako.de

Bremen/Lower Saxony (North)

Sales representative
Christoph Ewen

+49 172 8369928
ewen@eltako.de

Hamburg/Schleswig-Holstein

Sales representative
Thimo Barluschke

+49 173 5667242
barluschke@eltako.de

Hesse

Sales representative
Jonas Bieniek

+49 173 3207413
bieniek@eltako.de

Mecklenburg-Vorpommern/ Brandenburg (North)

Sales representative
Max Müller

+49 176 13582501
mueller@eltako.de

Lower Saxony (South/East)

Sales representative
Detlef Hilker

+49 173 3180390
hilker@eltako.de

North Rhine-Westphalia (North)/ Lower Saxony (West)

Sales representative
Michael Otte

+49 1520 9351347
otte@eltako.de

North Rhine-Westphalia (Rhineland North)

Gebietsrepräsentant
Almir Hodzic

+49 174 7302999
hodzic@eltako.de

North Rhine-Westphalia (Rhineland South)

Sales representative
Antonio Sanchez

+49 172 2178896
sanchez@eltako.de

North Rhine-Westphalia (Ruhrgebiet/Sauerland/Siegerland)

Sales representative
Mark Simon

+49 1520 9351348
simon@eltako.de

Rhineland-Palatinate/Saarland

Sales representative
Rainer Brilmayer

+49 176 13582516
brilmayer@eltako.de

Saxony

Sales representative
Mario Geißler

+49 162 2575121
geissler@eltako.de

Saxony-Anhalt/Thuringia

Sales representative
Andreas Misch

+49 176 13582505
misch@eltako.de

INTERNATIONAL CONTACT ADDRESSES AND SALES REPRESENTATIVES

Austria

T/Vbg./South Tyrol
Representative Daniel Hofler
+43 660 9241600
hofler@eltako.com

Austria

Carinthia - Representative
ÖW - System integrator
Winfried Rac
+43 660 8081310
rac@eltako.com

Austria

UA - System integrator
Andreas Kaider
+43 699 11090025
kaider@eltako.com

Belgium/France/Luxembourg

Serelec n.v.
B - 9000 Gent
+32 92 234 953
info@serelec-nv.be

Cyprus

MeshMade Ltd
CY-1096 Nicosia
www.meshmade.com

Denmark

SOLAR A/S
DK - 6600 Vejlen
www.solar.dk

Finland

Representative Roni Salonen
FIN-65100 Vaasa
+358 457 870 679 1
roni@eltako.com

Finland

Representative Tapio Rajamäki
FIN-45100 Kouvola
+358 457 870 679 2
tapio@eltako.com

Gulf area

M/S Golden Sand Trading
U.A.E. - Dubai
www.goldensandtrading.net

Great Britain

Sales manager Stephen Payne
+44 7810 094384
stephen.payne@eltako.com

Hong Kong, Malaysia, Macao, Singapore, the Philippines

TELCS Ltd.
HK-Hong Kong
www.telcs-design.com

Iceland

Reykjafell Ltd.
IS - 125 Reykjavik Iceland
www.reykjafell.is

Ireland

Inter-Konnect
IRL-Dublin
www.interkonnect.ie

Italien

Sales manager Carlo Palmieri
+39 329 6897235
carlo.palmieri@eltako.com

Italien

Representative Luca Ziosi
+39 320 3660345
luca.ziosi@eltako.com

Italien

Representative Nicola Carli
+39 320 6350851
nicola.carli@eltako.com

Netherlands (North)

Representative Hans Oving
NL - 7701 VV Dedemsvaart
+31 6 21816115
oving@eltako.com

Netherlands (South)

Representative Dennis Schellenberg
NL-5853 AL Siebengewald
+31 6 50419067
schellenberg@eltako.com

Norway

Malthe Winje Automasjon AS
NO-1415 Oppegard
www.mwg.no

Poland

ASTAT Logistyka Sp z o.o.
Dąbrowskiego 441
PL-60-451 Poznań
www.astat.com.pl

Portugal

TEV2, Lda
P-4470-434 Maia
www.tev.pt

Russia

ATLAS Group JSC
RU - 127591 Moscow
www.atlasgroup.ru

South Africa

Innomatic (Pty) Ltd. - Franz Markt
ZA - Midrand
www.innomatic.co.za

Spain

Sales manager Thomas Klassmann
E - 08398 Santa Susanna
+34 93 767 855 7
+34 650 959702
klassmann@eltako.com

Spain

Representative Oriol Montsec Fuego
E - 08303 Mataró
+34 692 835972
oriol@eltako.com

Spain

Repräsentant Alberto Graff
E-28300 Madrid
+34 697 896664
alberto@eltako.com

Sweden (North/Middle)

Senior representative Patrick Savinainen
S - 69332 Degerfors
+46 70 9596906
patrick@eltako.com

Sweden (West)

Representative Glenn Johansson
S - 43163 Mölndal
+46 73 5815692
glenn@eltako.com

Sweden (East)

Senior representative Dan Koril
S - 57475 Korsberga
+46 70 3201102
dan@eltako.com

Sweden (South)

Representative Magnus Ellemark
S-26192 Härslöv
+46 70 1702130
magnus@eltako.com

Sweden (Stockholm)

Representative Niklas Lundell
S-11330 Stockholm
+46 70 4875003
niklas@eltako.com

Switzerland

Demelectric AG
CH - 8954 Geroldswil
www.demelectric.ch

INTERNATIONAL CONTACT ADDRESSES AND SALES REPRESENTATIVES

Austria branch office

Eltako Austria
Warwitzstraße 9
A-5023 Salzburg
+49 711 943 500 00
info@eltako.at
kundenservice@eltako.at

Austria

Sbg./UA
Representative Robert Goedicke
+43 664 1823322
goedicke@eltako.com

Austria

V/Bgld.
Representative Miloš Mičićelović
+43 664 5186509
milos@eltako.com

Austria

LA/Styria
Representative Robert Papst
+43 664 1844122
papst@eltako.com

**DO YOU HAVE ANY QUESTIONS?
WE HAVE THE ANSWERS FOR YOU.**



The logo for Eltako, featuring the word "Eltako" in a white, cursive script font, centered within a dark purple square.

Eltako

Eltako GmbH

Hofener Straße 54
D-70736 Fellbach

+49 711 943 500 00
info@eltako.de

eltako.com

75 YEARS OF INNOVATION.