

M-BUS CENTER

SUITABLE FOR

20 / 60 / 120 / 250 METERS

[General information](#)

[Products & Solutions](#)

[Key features](#)

[Hardware](#)

[M-Bus to BACnet IP Gateway](#)

[M-Bus to BACnet IP Gateway](#)

[System architecture](#)



EMU - energy meters, data loggers and energy management software straight from the manufacturer - everything

GENERAL INFORMATION

The M-Bus Center with built-in heavy duty level converter ensures quick configuration and set-up. Automated readout of up to 250 meters guarantees error-free and continuous data collection for later analysis and billing as per ISO 50001. Energy usage becomes transparent and potential savings identified.

CUSTOMER BENEFITS

- Built-in M-Bus level converter for 20 / 60 / 120 / 250 M-Bus slaves
- Suitable for heat, water, gas and electric meters with M-Bus
- Web-enabled, remote readout via web browser
- Ad-hoc analysis & plausibility check
- Professional data processing
- Energy usage becomes transparent for targeted measures
- Firmware update & backup via web interface

FEATURES AND REQUIREMENTS AS PER ISO 50001

- Continuous data evaluation
- Visualisation incl. individual graphs
- Automated reporting
- Alerting
- Integration into existing systems
- Support & update service

EMU M-BUS CENTER: FLEXIBLE, EXPANDABLE

The M-Bus Center is configured entirely using an appealing, user-friendly interface operable with any customary web browser (HTML5). The graphic display shows the IP address configured manually or obtained via DHCP.

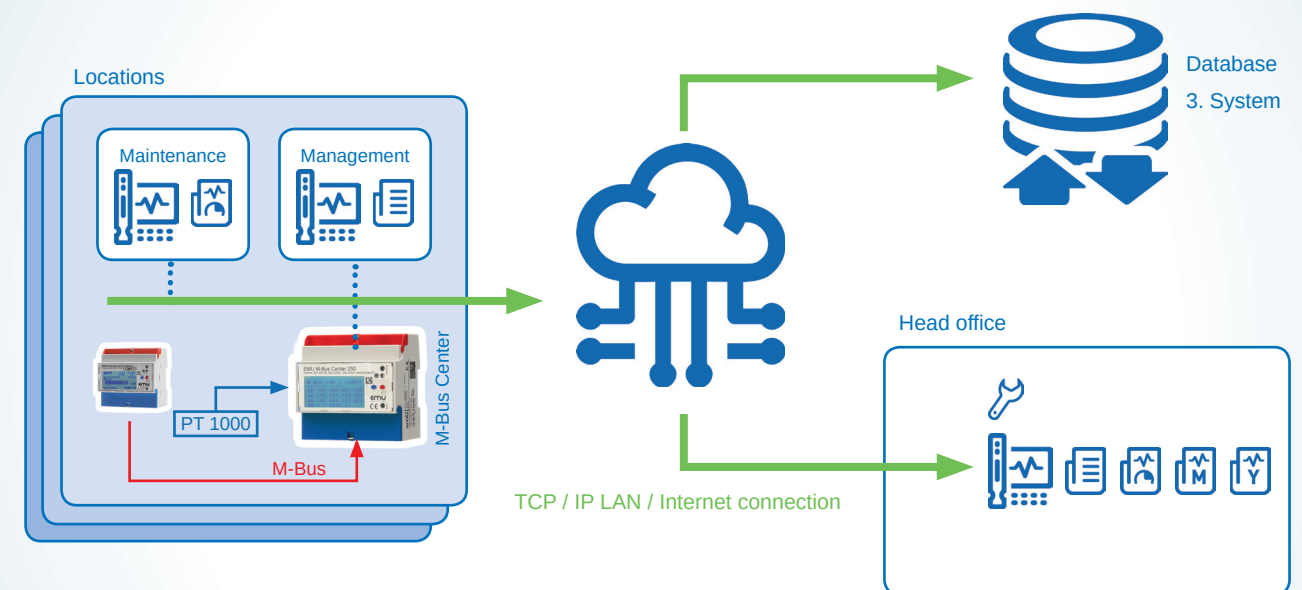

CUSTOMER BENEFITS

- M-Bus readout for 20 / 60 / 120 / 250 meters
- 2x temperature input PT1000
- 4x S0 pulse input
- Data logging and export for analysis
- New systems or retrofitting
- Suitable for energy data management as per ISO 50001

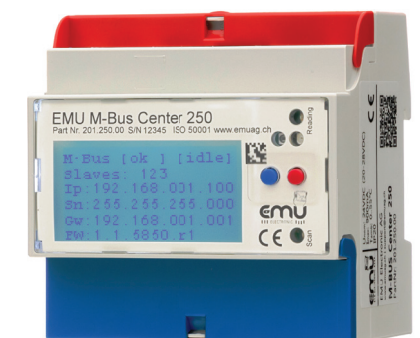

RECOMMENDED PRODUCTS

From energy meters, data loggers all the way to energy management software - we're your one stop source for all

Web-based energy management as per ISO 50001

Use our ISO 50001 Energy Management System software to monitor all usage data and bill utilities at the push of a button. The EMS software is quickly be integrated in an existing IT landscape and scaled to an unlimited number of meters regardless of the location.

- Visualisation incl. graphs and key figures
- Automatic analysis & reports via e-mail
- Monitoring and alerting, threshold values
- Multi-user capability, multilingual
- Suitable for electric, water, heat and gas



	Article number	Designation
Energy Management ISO 50001	EMS0EL000	Energy Management ISO 50001 Joulio-Web Basic
	LIC0EL010	Licence for 10 devices
	LIC0EL050	Licence for 50 devices

COMPREHENSIVE SOLUTION

3-phase energy meters

Our EMU Professional and EMU Allrounder are excellent for use in manufacturing plants, cost centre billing, sub-metering, performance control and energy management as per ISO 50001.

- Direct connection 75A or for transformer /5A and /1A
- Accuracy class B (1%)
- MID B+D and CE certified
- Dual tariff (Peak/Off-Peak)
- M-Bus, Modbus, LON, KNX, TCP/IP interface



	Article number	Designation
Energy meters with M-Bus interface and MID approval	A020000M	EMU Allrounder 3/75 M-Bus, 3x230/400V, 75A
	A120000M	EMU Allrounder 3/5 M-Bus, 3x230/400V, CT /5 and /1A
	950506	EMU 1/32 M-Bus, 230V, 32A

Local service

- Record actual status, targets and proposed solutions
- Measuring concept proposal
- Set-up and configuration
- Training & online support



Protection of investment

The open communication and Gateway functions allow our energy meters and data loggers to communicate with systems of different manufacturers. This protects your hardware and installation investments.



KEY FEATURES

GENERAL MENU NAVIGATION

- Home page with user-friendly grouping
- Overview of all meters
- Meter and data logger configuration
- Backup and data export
- Status of the M-Bus readout is immediately visible



SET-UP

- Automatic meter scan
- Supports M-Bus primary and secondary address
- 300 to 9600 baud
2400 baud recommended

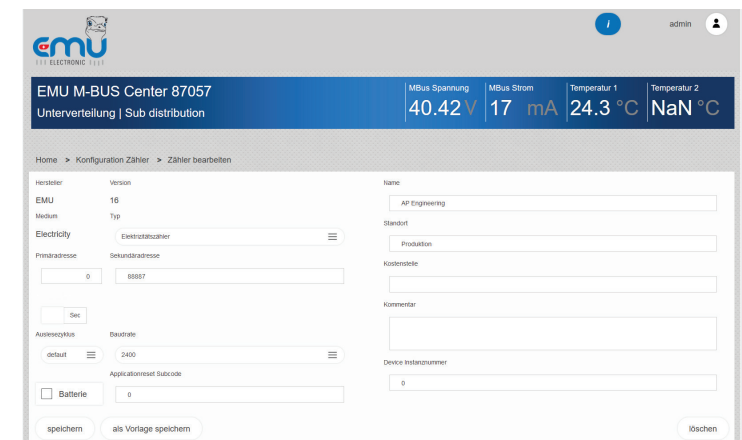

COMPATIBILITY

- Meters with M-Bus interface per EN 13757-2,-3, e.g. electric, water, heat, gas
- S0 pulse inputs
- PT1000 temperature sensor
- Individual M-Bus device driver via web interface

INTEGRATION INTO EXISTING SYSTEMS

- Measurement data export (.csv and JSON)
- M-Bus to BACnet IP Gateway function
- M-Bus to OPC UA Gateway function
- (s)FTP upload

KEY FEATURES



VISUALISATION

- Bar graph
- Daily usage
- Weekly usage
- Monthly usage
- Annual usage

HARDWARE AND SOFTWARE

- Integrated high performance level converter
- MicroSD card for data storage
- Modular software architecture
- M-Bus short-circuit and excess current monitor

ALARMS

- Meter readout failure
- M-Bus error flags analysis
- Monitor for communication with third-party systems
- Relay outputs for alarm system

HARDWARE

GRAPHIC LCD

Graphic 60x30mm LCD with backlight for user-friendly network configuration.

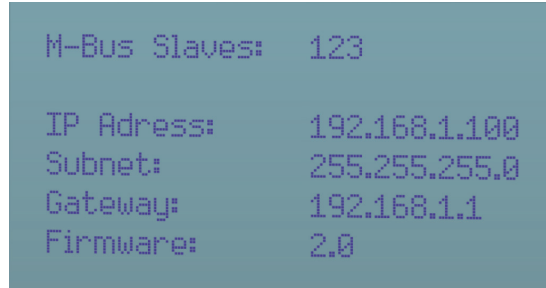

CONNECTIONS

Ports	1 x USB type A 1 x USB type B 1 x Ethernet 10/100 Base RJ45
Inputs	3 x M-Bus 4 x S0 pulse input 2 x temperature PT1000
Output to BMS	BACnet IP and OPC UA
Outputs	2 x relay
Operating voltage	24VDC
Power input	Max. 1A

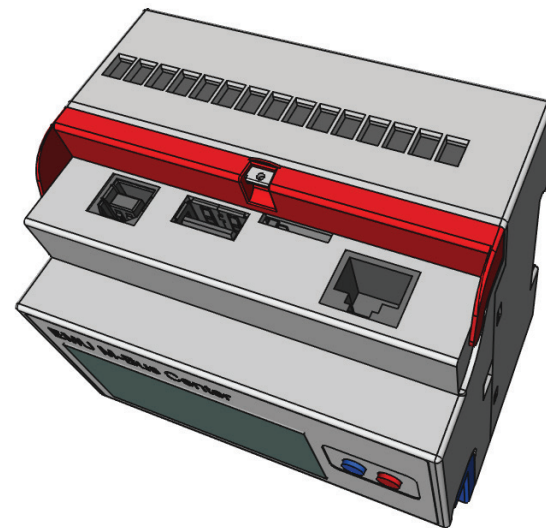

Access any time, anywhere

The web interface of the EMU M-Bus Center is easily operated from any PC or tablet via web browser.

1.

INSTALLATION

Full configuration via IP address and web browser. The EMU M-Bus Center scans all connected meters via M-Bus secondary or primary address. Connects to the higher-level energy management system per ISO 50001 with just a few clicks.

2.

PLUG & PLAY CONFIGURATION

The connected meters are marked. Name, location, cost centre and comments are defined by meter.

3.

MEASUREMENTS - MEDIUMS

The open, integral energy management system reads all energy meters via M-Bus interface per EN 13757-2, -3. When required, individual device drivers are created on the EMU M-Bus Center, exported and transferred to other M-Bus.

In addition to active and reactive energy, the energy meters (electricity) for EMU also provide a number of other measurements, e.g. current, voltage, power ratings, Cos-Phi, frequency, etc. Of course these measurements are archived and transmitted to the higher-level energy management system.

4.

SECURITY

The clock is synchronised via Net Time Protocol (NTP) server. Faults are recorded in the event log and reported via e-mail.



Article number	Designation
201.250.00	M-Bus Center for 250 M-Bus meters
201.120.00	M-Bus Center for 120 M-Bus meters
201.060.00	M-Bus Center for 60 M-Bus meters
201.020.00	M-Bus Center for 20 M-Bus meters
940083	Power supply output 24VDC 1A, input 100-240VAC

GRAPHIC ANALYSIS

GENERAL MENU NAVIGATION

- Home page with user-friendly grouping
- Overview of all meters
- Meter and data logger configuration
- Backup and data export

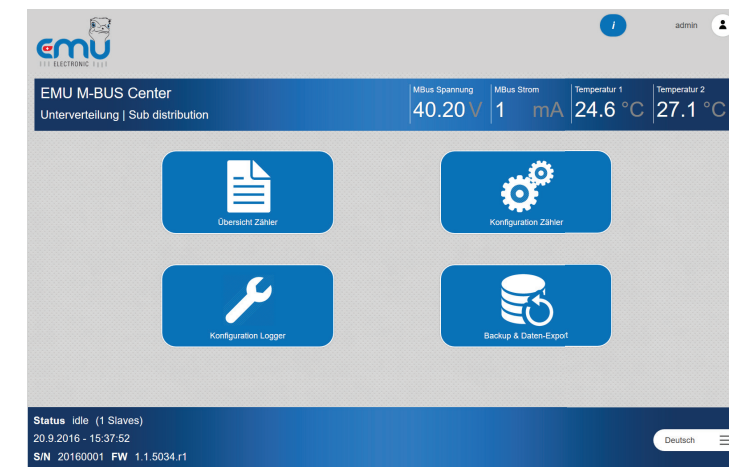

GRAPHIC USAGE ANALYSIS

- Usage per day v. previous day
- Usage per week v. previous week
- Usage per month v. previous 12 months



CURRENT AND HISTORIC MEASUREMENTS

- Meter identification including name, cost centre and location
- Measurements of the last readout
- Last readout on specific dates, e.g. end of month

#	Name	aktuell	Einheit
0	Fabrikationsnummer	27949 000	none
1	Wirkenergie Bezug / Tarif 1	40960.63	kWh
2	Wirkenergie Bezug / Tarif 2	18667.73	kWh
3	Blindenergie Bezug induktiv / Tarif 1	370.57	kvarh
4	Blindenergie Bezug induktiv / Tarif 2	665.92	kvarh
5	Wirkleistung / Phase L1	2.22	kW
6	Wirkleistung / Phase L2	1.26	kW
7	Wirkleistung / Phase L3	0.92	kW
8	Wirkleistung	4.43	kW
9	Blindleistung / Phase L1	-1.22	kvar

IOT AND INDUSTRY 4.0

The Internet of Things (IoT) has been inspiring the economy and science alike for about 25 years. Machines and systems which communicate with each other automatically, control and optimise themselves are the next level of automation - the so-called Industry 4.0.

The M-Bus Center features modern communication options with a service-based architecture and encrypted communication channels.

FLEXIBLE SYSTEM EXPANSION

Easy expansion of existing M-Bus systems

- Multi-manufacturer meter readout
- Cost-effective entry into effective, future-oriented energy management as per ISO 50001 along with industrial and residential utility billing.

USER MANAGEMENT

Each user is assigned a separate password-protected login. Create any number of users and define the respective access authorisations.

M-BUS SYSTEM

- Polarity: Protected against reverse polarity, polarity independent
- Compatible topologies: Star, tree and linear structure
- Two-core, if possible shielded
- J-Y(ST) Y 2 x 2 x 0.8 mm
- Minimum distance to electric circuit, EMC interference
- M-Bus line as short as possible
- Master = EMU M-Bus Center / level converter

MULTILINGUAL

The EMU M-Bus Center is successfully being used on an international level. The web interface is multi-lingual.

M-BUS TO BACNET IP GATEWAY

B-ASC certified and BBMD function

The M-Bus Center is furthermore an ideal system component for integration into a BACnet IP network. Once an M-Bus slave is registered or imported to a Center, it is immediately readable via the BACnet IP. The M-Bus Center and the registered M-Bus slaves are each detected as separate device objects with a static list of analogue input objects (M-Bus measurements). Integration into a higher-level BACnet IP system requires virtually no configuration.

PLUG & PLAY CONFIGURATION

The automatic scan automatically detects and lists all connected M-Bus meters. The meters are then be configured. Each meter is assigned a name, cost centre and comments.

USB LEVEL CONVERTER

The M-Bus Center can be used as a USB level converter. Existing M-Bus software tools can communicate with the M-Bus via USB port.

OPC UA

All M-Bus values can be read via OPC UA by the local building management system.

METERS & READOUT

All energy meters (e.g. water, heat, current and gas) with M-Bus interface per EN 13757-2,-3 (formerly EN1434-2,-3) are read out via two-wire line. Measurements and usage are archived to a SQL database. Two PT1000 temperature sensor are used to record e.g. the indoor and outdoor temperature.

Usage data can be analysed from any computer or tablet via IP address and web browser. The built-in data evaluation (web server) eliminates the need for M-Bus readout software.



REFERENCE PROJECT: ETH HWW LIVINGSCIENCE

- Over 1300 meters (electricity, water and heat)
- Readout via EMU M-Bus Center
- Web-based access for over 400 users, multilingual
- Individual software expansion

Management always has an overview of energy usage and variances. Just shortly after being set up the EMS software detected a variance (increased water usage) and prevented undesirable additional costs.

Locations

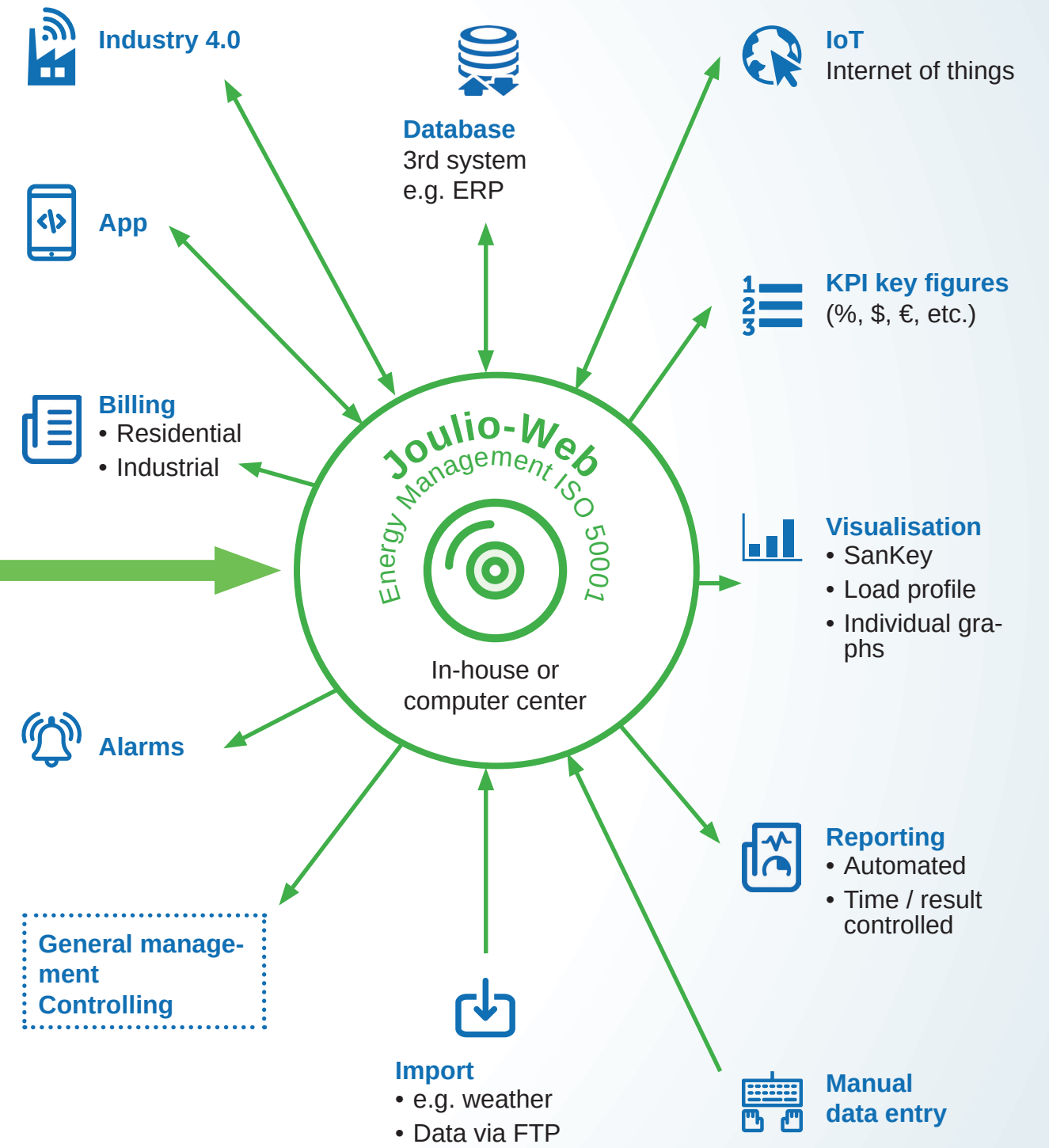
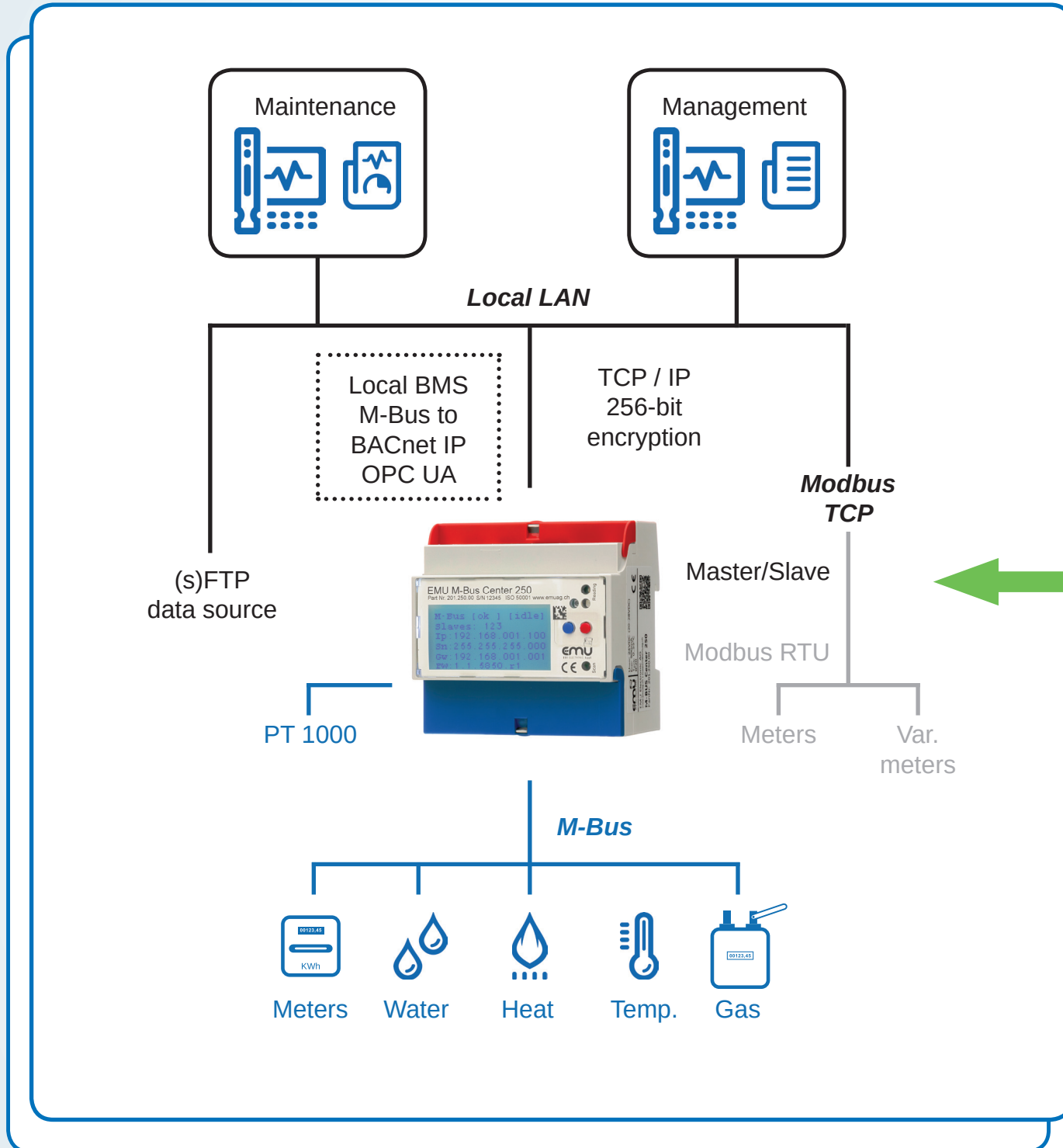

WIRING DIAGRAM

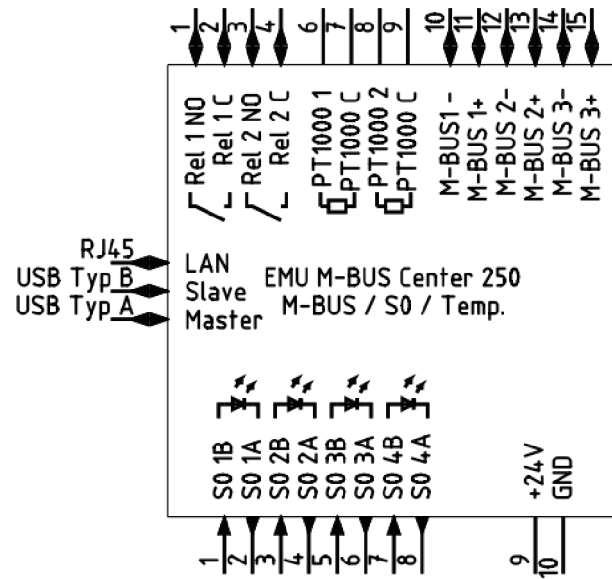

PRODUCT INFORMATION

Number of M-Bus slaves	Max. 20 / 60 / 120 / 250, (250 x 1.5mA) see ordering information
Analysis	Web server / graph suitable for ISO 50001
Ports	1 x USB type A 1 x USB type B 1 x Ethernet 10/100 Base RJ45
Inputs	3 x M-Bus 4 x S0 pulse input 2 x temperature PT1000
Outputs	2 x relay
M-Bus level converter	Integrated heavy duty level converter
Data export	.csv and JSON file, other formats upon request
Data storage	MicroSD card, SQL
Firmware update	Yes, via user interface
Backup	Yes, via user interface
Configuration	Local and remote configuration via web server

DIMENSIONAL DRAWING

The narrow 90mm M-Bus Center mounts on a DIN rail.

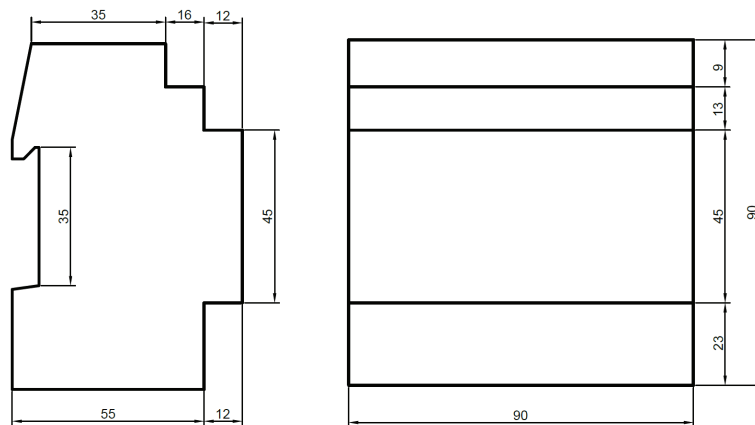

TECHNICAL DATA

Operating voltage	24VDC
Power input	Max. 1A
Temperature range	0-55°C
M-Bus baud rate	300, 600, 1200, 2400, 4800, 9600
M-Bus standby current	Max. 375mA (250 x 1.5mA), see ordering information
Compatibility	Heat, water, gas and electricity meters with M-Bus per EN 13757-2, -3 (formerly EN1434-3)
Galvanic isolation, short circuit and overload protection	Yes
Security	CE mark
EMC measurement	EN 61000-6-2
Immunity	EN 61000-6-3
M-Bus standard	EN 13757-2,-3
Energy management	Suitable for ISO 50001
BACnet IP	B-ASC certified
Display	LCD with backlight
Weight	Approx. 400g
Installation	35mm DIN rail
Housing	Polycarbonate, recyclable, non-flammable

ORDERING INFORMATION

EVERYTHING YOU NEED FOR ENERGY MANAGEMENT

	Article number	Designation
M-Bus data logger	201.250.00	M-Bus Center for 250 M-Bus meters
	201.120.00	M-Bus Center for 120 M-Bus meters
	201.060.00	M-Bus Center for 60 M-Bus meters
	201.020.00	M-Bus Center for 20 M-Bus meters
Energy Management ISO 50001 Local installation	EMS0EL000	Energy Management ISO 50001 Joulio Basic Incl. Licence for 30 devices
	LIC0EL010	Licence for 10 devices
	LIC0EL050	Licence for 50 devices
	LIC0EL100	Licence for 100 devices
	LIC0EL250	Licence for 250 devices
	LIC0EL500	Licence for 500 devices
Energy Management Update	UP0EL000	Update Joulio-Web Basic Incl. 30 devices
	UP0ELL00	Update Joulio-Web additional devices
Energy meters with interface and MID approval	A020000M	EMU Allrounder 3/75 M-Bus, 3x230/400V, 75A
	A120000M	EMU Allrounder 3/5 M-Bus, 3x230/400V, CT /5 + /1A
	950506	EMU 1/32 M-Bus, 230V, 32A
	P020000T	EMU Professional 3/75 TCP/IP, 3x230/400V, 75A
	P120000T	EMU Professional 3/5 TCP/IP, 3x230/400V, CT /5 + /1A

Would you like to analyse and monitor **more than 500 meters**?
We will gladly work with you to define the optimal solution and license.

Data specified in the product catalogue has been compiled in all conscience. Changes and errors expressly reserved. "Images similar" does not constitute a term of contract. This is a notice without autonomous scope which merely states the information in the catalogue is preliminary and non-binding in that it may be corrected before or on conclusion of contract. These notices do not provide any contractual scope, particularly any limitation in the rights of the contracting party with respect to liability or warranty.

We compile and update our compatibility lists with utmost care. Please contact our support service to verify compatibility with existing meters.

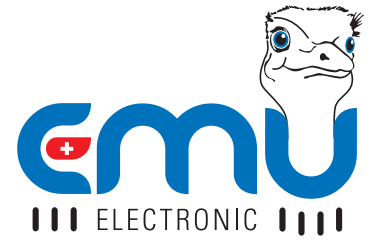

EMU Electronic AG

Jöchlerweg 2

6340 Baar

Switzerland

Tel. +41 (0)41 545 03 00

Fax: +41 (0)41 545 03 01

E-Mail: info@emuag.ch

Website: www.emuag.ch

Date: 2018.01.01

Technical changes reserved.