



# **GIOVENZANA**

---

## INTERNATIONAL B.V.



**AUXILIARY CONTROLS**  
**PEGASUS SERIES**

### PUSH BUTTONS Ø22 | WITH COLOUR CAP

MOMENTARY



TYPE	COLOUR INDEX	CODE	WEIGHT grammi	MIN. PACK QUANTITY
FLUSH PUSH BUTTON	■	PPRN1	30	10
	■	PPRN2	30	10
	■	PPRN3	30	10
	■	PPRN4	30	10
	■	PPRN5	30	10
	■	PPRN8	30	10

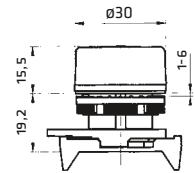

TYPE	COLOUR INDEX	CODE	WEIGHT grammi	MIN. PACK QUANTITY
EXTENDED PUSH BUTTON	■	PPSN1	31	10
	■	PPSN2	31	10
	■	PPSN3	31	10
	■	PPSN4	31	10
	■	PPSN5	31	10
	■	PPSN8	31	10

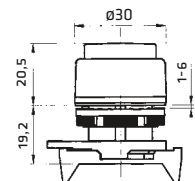

LATCHED



TYPE	COLOUR INDEX	CODE	WEIGHT grammi	MIN. PACK QUANTITY
FLUSH PUSH BUTTON	■	PPPN1	32	10
	■	PPPN2	32	10
	■	PPPN3	32	10
	■	PPPN4	32	10
	■	PPPN5	32	10
	■	PPPN8	32	10

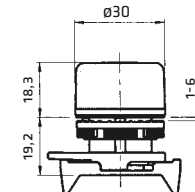

TYPE	COLOUR INDEX	CODE	WEIGHT grammi	MIN. PACK QUANTITY
MUSHROOM OPERATOR Ø40	■	PPFN154N	35	10
	■	PPFN254N	35	10
	■	PPFN354N	35	10

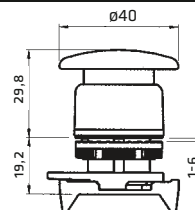

## AUXILIARY CONTROLS | PEGASUS SERIES

## PUSH BUTTONS Ø22 | WITH LENS CAP

MOMENTARY



TYPE	COLOUR INDEX	CODE	WEIGHT grammi	MIN. PACK QUANTITY	SIZES
FLUSH PUSH BUTTON	■	PPRL1	30	10	
	■	PPRL2	30	10	
	■	PPRL3	30	10	
	■	PPRL4	30	10	
	■	PPRL5	30	10	

LATCHED



TYPE	COLOUR INDEX	CODE	WEIGHT grammi	MIN. PACK QUANTITY	SIZES
EXTENDED PUSH BUTTON	■	PPSL1	31	10	
	■	PPSL2	31	10	
	■	PPSL3	31	10	
	■	PPSL4	31	10	
	■	PPSL5	31	10	

IND. LIGHT



TYPE	COLOUR INDEX	CODE	WEIGHT grammi	MIN. PACK QUANTITY	SIZES
FLAT CAP	■	PLSL1NL	30	10	
	■	PLSL2NL	30	10	
	■	PLSL3NL	30	10	
	■	PLSL4NL	30	10	
	■	PLSL5NL	30	10	



**LED PILOT LIGHT Ø22**



DESCRIPTION	POWER SUPPLY	CODE	WEIGHT grammi	MIN. PACK QUANTITY
SINGLE LED INDICATOR  X1 — ⊗ — X2	AC/DC 6V <b>1</b>	PLML <b>2</b> L6	15	10
	AC/DC 12V <b>1</b>	PLML <b>2</b> L12	15	10
	AC/DC 24V	PLML <b>2</b> L24	15	10
	AC/DC 48V	PLML <b>2</b> L48	15	10
	AC/DC 110V	PLML <b>2</b> L110	15	10
	AC 220V	PLML <b>2</b> L220	15	10
	AC 380V <b>1</b>	PLML <b>2</b> L380	15	10

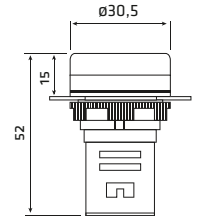

**COMPLY WITH RULES**

**EN60947-5-1 / GB14048.5**

**DIAGRAM**

Operational temperature	°C	-5 +40
Operational umidity		45% ... 90%
AC rated frequency	Hz	50/60
Rated insulation voltage	1 min V	2500V
Over voltage category	EN60947.1	III
Pollution grade	EN60947.1	3
Protection degree	EN60529	IP65, IP2X terminals
Connection:		
Terminal block caliber		A2
Terminal screw		M3,5
Flexible and solid conductor section	min/max	n. 1 1/2,5 mm <sup>2</sup> - n. 2 1/2,5 mm <sup>2</sup>
Rated operational voltage Ue	AC/DC V	6, 12, 24, 48, 110
	AC V	220 - 380
Rated operational voltage Ie	mA	≤80 6,12V
	mA	≤20 24, 48, 110, 220, 380V
Electrical life	h	≥30.000
Brightness	cd/m <sup>2</sup>	100
Mounting	mm	Ø22,5

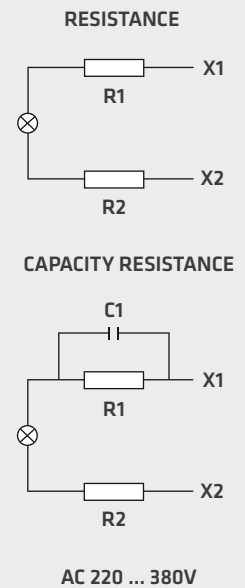

## AUXILIARY CONTROLS | PEGASUS SERIES

## MULTIFUNCTION PUSH BUTTONS Ø22 | NOT LIGHT



TYPE	COLOUR INDEX	CODE	WEIGHT grammi	MIN. PACK QUANTITY	SIZES
DUAL PUSH BUTTON		PPDN	38	10	



TYPE	COLOUR INDEX	CODE	WEIGHT grammi	MIN. PACK QUANTITY	SIZES
FLUSH DUAL PUSH BUTTON		PPDNR	38	10	
		PPDNR.3	38	10	



TYPE	COLOUR INDEX	CODE	WEIGHT grammi	MIN. PACK QUANTITY	SIZES
DUAL PUSH BUTTON		PPMN	40	10	

## MULTIFUNCTION PUSH BUTTONS Ø22 | LIGHT



TYPE	COLOUR INDEX	CODE	WEIGHT grammi	MIN. PACK QUANTITY	SIZES
DUAL PUSH BUTTON		PPDL	30	10	
		PPDL.1	30	10	



TYPE	COLOUR INDEX	CODE	WEIGHT grammi	MIN. PACK QUANTITY	SIZES
FLUSH DUAL PUSH BUTTON		PPDLR	30	10	
		PPDLR.3	30	10	



**ROTARY SWITCHES Ø22**

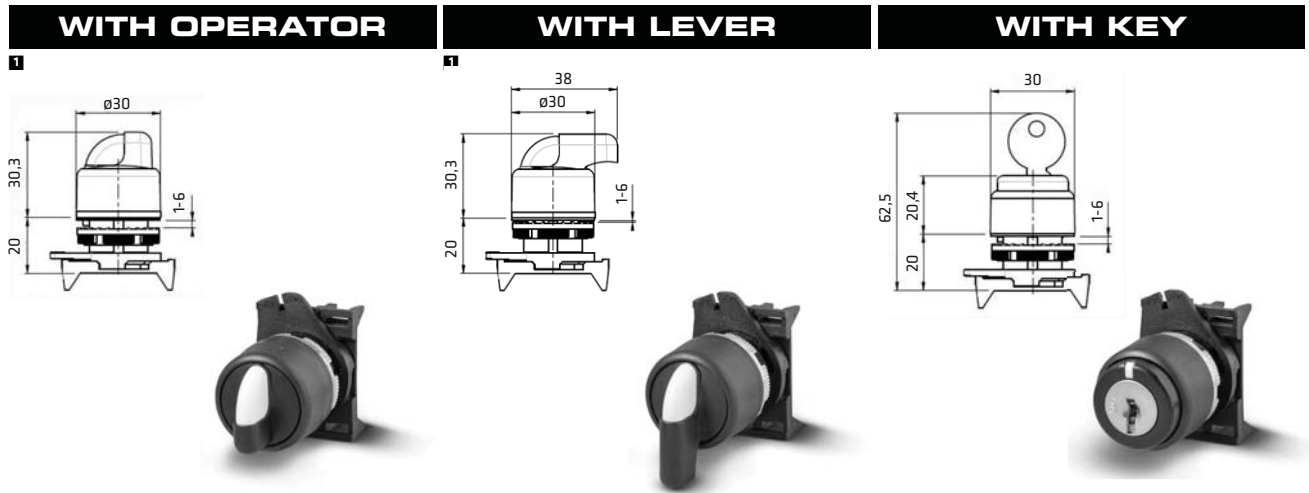

POSITION	COLOUR INDEX	CODE	COLOUR INDEX	CODE	KEY REMOVAL			CODE
					L	O	R	
 90°	■	PSMB1D0	■	PSLB1D0		*		PSCR8D0C
	■	PSMB2D0	■	PSLB2D0				
	■	PSMB3D0	■	PSLB3D0			*	PSCR8D0E
	■	PSMB4D0	■	PSLB4D0				
	■	PSMB5D0	■	PSLB5D0		*	*	PSCR8D0N
	■	PSMB8D0	■	PSLB8D0				
 45°	■	PSMB1D2	■	PSLB1D2				PSCR8D2C
	■	PSMB2D2	■	PSLB2D2		*		
	■	PSMB3D2	■	PSLB3D2				
	■	PSMB4D2	■	PSLB4D2				
	■	PSMB5D2	■	PSLB5D2				
	■	PSMB8D2	■	PSLB8D2				
 45°	■	PSMB1T0	■	PSLB1T0	*	*		PSR8T0C
	■	PSMB2T0	■	PSLB2T0				PSR8T0A
	■	PSMB3T0	■	PSLB3T0			*	PSR8T0E
	■	PSMB4T0	■	PSLB4T0	*	*	*	PSR8T0G
	■	PSMB5T0	■	PSLB5T0	*	*		PSR8T0H
	■	PSMB8T0	■	PSLB8T0	*	*	*	PSR8T0K
 45°	■	PSMB1T3	■	PSLB1T3			*	PSCR8T3C
	■	PSMB2T3	■	PSLB2T3				
	■	PSMB3T3	■	PSLB3T3				
	■	PSMB4T3	■	PSLB4T3				
	■	PSMB5T3	■	PSLB5T3				
	■	PSMB8T3	■	PSLB8T3				
 45°	■	PSMB1T2	■	PSLB1T2		*		PSCR8T2C
	■	PSMB2T2	■	PSLB2T2	*			PSCR8T2A
	■	PSMB3T2	■	PSLB3T2				
	■	PSMB4T2	■	PSLB4T2				
	■	PSMB5T2	■	PSLB5T2	*	*		PSCR8T2H
	■	PSMB8T2	■	PSLB8T2				
 45°	■	PSMB1T1	■	PSLB1T1		*		PSCR8T1C
	■	PSMB2T1	■	PSLB2T1			*	PSCR8T1E
	■	PSMB3T1	■	PSLB3T1				
	■	PSMB4T1	■	PSLB4T1				
	■	PSMB5T1	■	PSLB5T1		*	*	PSCR8T1N
	■	PSMB8T1	■	PSLB8T1				

1 For standard rotary switches suitable to operate a central contact, replace the letter "B" with the letter "C": PSMB1D0 or PSLB1D0  
 2 For rotary switches with Left - Right operating angles replace the letters "DO" with "SD": PSMB1D0 or PSLB1D0

\* Key removable position



## AUXILIARY CONTROLS | PEGASUS SERIES

## JOYSTICK OPERATORS Ø22 | IP65

## 2 POSITIONS

## Horizontal

## Vertical

CONTACT BLOCKS		1	0	2
Left-hand side contact block	NO	X	0	0
	NC	0	0	X
Right-hand side contact block	NO	0	0	X
	NC	X	0	0

1	0	2
X	0	X
0	0	0
X	0	0
0	0	X

X Contact close  
0 Contact open

## 4 POSITIONS

3	1	0	2	4
X	0	0	0	0
0	0	0	0	X
0	X	0	0	0
0	0	0	X	0

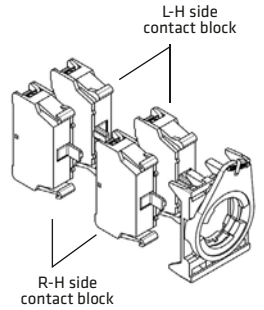
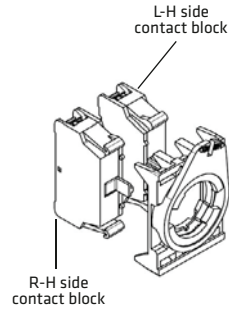

POSITION	CODE	WEIGHT	MIN. PACK	SIZES
1 0 2	PMJN8T0	58 gr	5	
1 0 2	PMJN8T3			
1 3 0 4 2	PMJN8Q0			
1 3-0-4 2	PMJN8Q4			
1 0 2	PMJN80S			
1-0-2	PMJN80R			



POSITION	CODE	WEIGHT	MIN. PACK	SIZES
1 0 2	PMJN8T01	51 gr	5	
1 0 2	PMJN8T31			
1 3 0 4 2	PMJN8Q01			
1 3-0-4 2	PMJN8Q41			
1 0 2	PMJN80S1			
1-0-2	PMJN80R1			

### EMERGENCY PUSH BUTTONS Ø22 | EN ISO 13850

	<table border="1"> <thead> <tr> <th>TYPE</th> <th>COLOUR INDEX</th> <th>CODE</th> <th>WEIGHT (gr)</th> <th>MIN. PACK QUANTITY</th> </tr> </thead> <tbody> <tr> <td>MUSHROOM OPERATOR Ø30 TWIST TO RELEASE</td> <td>■</td> <td>PPFN1R3N</td> <td>42</td> <td>10</td> </tr> </tbody> </table>	TYPE	COLOUR INDEX	CODE	WEIGHT (gr)	MIN. PACK QUANTITY	MUSHROOM OPERATOR Ø30 TWIST TO RELEASE	■	PPFN1R3N	42	10	<table border="1"> <thead> <tr> <th>TYPE</th> <th>COLOUR INDEX</th> <th>CODE</th> <th>WEIGHT (gr)</th> <th>MIN. PACK QUANTITY</th> </tr> </thead> <tbody> <tr> <td>MUSHROOM OPERATOR WITH VISION Ø30 TWIST TO RELEASE</td> <td>■</td> <td>PPFN1R3S</td> <td>44</td> <td>10</td> </tr> </tbody> </table>	TYPE	COLOUR INDEX	CODE	WEIGHT (gr)	MIN. PACK QUANTITY	MUSHROOM OPERATOR WITH VISION Ø30 TWIST TO RELEASE	■	PPFN1R3S	44	10	<table border="1"> <thead> <tr> <th>TYPE</th> <th>COLOUR INDEX</th> <th>CODE</th> <th>WEIGHT (gr)</th> <th>MIN. PACK QUANTITY</th> </tr> </thead> <tbody> <tr> <td>MUSHROOM OPERATOR Ø40 TWIST TO RELEASE</td> <td>■</td> <td>PPFN1R4N</td> <td>44</td> <td>10</td> </tr> </tbody> </table>	TYPE	COLOUR INDEX	CODE	WEIGHT (gr)	MIN. PACK QUANTITY	MUSHROOM OPERATOR Ø40 TWIST TO RELEASE	■	PPFN1R4N	44	10	<table border="1"> <thead> <tr> <th>TYPE</th> <th>COLOUR INDEX</th> <th>CODE</th> <th>WEIGHT (gr)</th> <th>MIN. PACK QUANTITY</th> </tr> </thead> <tbody> <tr> <td>MUSHROOM OPERATOR WITH VISION Ø40 TWIST TO RELEASE</td> <td>■</td> <td>PPFN1R4S</td> <td>46</td> <td>10</td> </tr> </tbody> </table>	TYPE	COLOUR INDEX	CODE	WEIGHT (gr)	MIN. PACK QUANTITY	MUSHROOM OPERATOR WITH VISION Ø40 TWIST TO RELEASE	■	PPFN1R4S	46	10	<table border="1"> <thead> <tr> <th>TYPE</th> <th>COLOUR INDEX</th> <th>CODE</th> <th>WEIGHT (gr)</th> <th>MIN. PACK QUANTITY</th> </tr> </thead> <tbody> <tr> <td>MUSHROOM OPERATOR Ø60 TWIST TO RELEASE</td> <td>■</td> <td>PPFN1R6N</td> <td>50</td> <td>10</td> </tr> </tbody> </table>	TYPE	COLOUR INDEX	CODE	WEIGHT (gr)	MIN. PACK QUANTITY	MUSHROOM OPERATOR Ø60 TWIST TO RELEASE	■	PPFN1R6N	50	10	<table border="1"> <thead> <tr> <th>TYPE</th> <th>COLOUR INDEX</th> <th>CODE</th> <th>WEIGHT (gr)</th> <th>MIN. PACK QUANTITY</th> </tr> </thead> <tbody> <tr> <td>MUSHROOM OPERATOR WITH VISION Ø60 TWIST TO RELEASE</td> <td>■</td> <td>PPFN1R6S</td> <td>52</td> <td>10</td> </tr> </tbody> </table>	TYPE	COLOUR INDEX	CODE	WEIGHT (gr)	MIN. PACK QUANTITY	MUSHROOM OPERATOR WITH VISION Ø60 TWIST TO RELEASE	■	PPFN1R6S	52	10				
TYPE	COLOUR INDEX	CODE	WEIGHT (gr)	MIN. PACK QUANTITY																																																																		
MUSHROOM OPERATOR Ø30 TWIST TO RELEASE	■	PPFN1R3N	42	10																																																																		
TYPE	COLOUR INDEX	CODE	WEIGHT (gr)	MIN. PACK QUANTITY																																																																		
MUSHROOM OPERATOR WITH VISION Ø30 TWIST TO RELEASE	■	PPFN1R3S	44	10																																																																		
TYPE	COLOUR INDEX	CODE	WEIGHT (gr)	MIN. PACK QUANTITY																																																																		
MUSHROOM OPERATOR Ø40 TWIST TO RELEASE	■	PPFN1R4N	44	10																																																																		
TYPE	COLOUR INDEX	CODE	WEIGHT (gr)	MIN. PACK QUANTITY																																																																		
MUSHROOM OPERATOR WITH VISION Ø40 TWIST TO RELEASE	■	PPFN1R4S	46	10																																																																		
TYPE	COLOUR INDEX	CODE	WEIGHT (gr)	MIN. PACK QUANTITY																																																																		
MUSHROOM OPERATOR Ø60 TWIST TO RELEASE	■	PPFN1R6N	50	10																																																																		
TYPE	COLOUR INDEX	CODE	WEIGHT (gr)	MIN. PACK QUANTITY																																																																		
MUSHROOM OPERATOR WITH VISION Ø60 TWIST TO RELEASE	■	PPFN1R6S	52	10																																																																		
	<table border="1"> <thead> <tr> <th>TYPE</th> <th>COLOUR INDEX</th> <th>CODE</th> <th>WEIGHT (gr)</th> <th>MIN. PACK QUANTITY</th> </tr> </thead> <tbody> <tr> <td>MUSHROOM OPERATOR Ø40 TWIST TO RELEASE</td> <td>■</td> <td>PPFN1R4N</td> <td>44</td> <td>10</td> </tr> </tbody> </table>	TYPE	COLOUR INDEX	CODE	WEIGHT (gr)	MIN. PACK QUANTITY	MUSHROOM OPERATOR Ø40 TWIST TO RELEASE	■	PPFN1R4N	44	10	<table border="1"> <thead> <tr> <th>TYPE</th> <th>COLOUR INDEX</th> <th>CODE</th> <th>WEIGHT (gr)</th> <th>MIN. PACK QUANTITY</th> </tr> </thead> <tbody> <tr> <td>MUSHROOM OPERATOR WITH VISION Ø40 TWIST TO RELEASE</td> <td>■</td> <td>PPFN1R4S</td> <td>46</td> <td>10</td> </tr> </tbody> </table>	TYPE	COLOUR INDEX	CODE	WEIGHT (gr)	MIN. PACK QUANTITY	MUSHROOM OPERATOR WITH VISION Ø40 TWIST TO RELEASE	■	PPFN1R4S	46	10	<table border="1"> <thead> <tr> <th>TYPE</th> <th>COLOUR INDEX</th> <th>CODE</th> <th>WEIGHT (gr)</th> <th>MIN. PACK QUANTITY</th> </tr> </thead> <tbody> <tr> <td>MUSHROOM OPERATOR Ø60 TWIST TO RELEASE</td> <td>■</td> <td>PPFN1R6N</td> <td>50</td> <td>10</td> </tr> </tbody> </table>	TYPE	COLOUR INDEX	CODE	WEIGHT (gr)	MIN. PACK QUANTITY	MUSHROOM OPERATOR Ø60 TWIST TO RELEASE	■	PPFN1R6N	50	10	<table border="1"> <thead> <tr> <th>TYPE</th> <th>COLOUR INDEX</th> <th>CODE</th> <th>WEIGHT (gr)</th> <th>MIN. PACK QUANTITY</th> </tr> </thead> <tbody> <tr> <td>MUSHROOM OPERATOR WITH VISION Ø60 TWIST TO RELEASE</td> <td>■</td> <td>PPFN1R6S</td> <td>52</td> <td>10</td> </tr> </tbody> </table>	TYPE	COLOUR INDEX	CODE	WEIGHT (gr)	MIN. PACK QUANTITY	MUSHROOM OPERATOR WITH VISION Ø60 TWIST TO RELEASE	■	PPFN1R6S	52	10																										
TYPE	COLOUR INDEX	CODE	WEIGHT (gr)	MIN. PACK QUANTITY																																																																		
MUSHROOM OPERATOR Ø40 TWIST TO RELEASE	■	PPFN1R4N	44	10																																																																		
TYPE	COLOUR INDEX	CODE	WEIGHT (gr)	MIN. PACK QUANTITY																																																																		
MUSHROOM OPERATOR WITH VISION Ø40 TWIST TO RELEASE	■	PPFN1R4S	46	10																																																																		
TYPE	COLOUR INDEX	CODE	WEIGHT (gr)	MIN. PACK QUANTITY																																																																		
MUSHROOM OPERATOR Ø60 TWIST TO RELEASE	■	PPFN1R6N	50	10																																																																		
TYPE	COLOUR INDEX	CODE	WEIGHT (gr)	MIN. PACK QUANTITY																																																																		
MUSHROOM OPERATOR WITH VISION Ø60 TWIST TO RELEASE	■	PPFN1R6S	52	10																																																																		
	<table border="1"> <thead> <tr> <th>TYPE</th> <th>COLOUR INDEX</th> <th>CODE</th> <th>WEIGHT (gr)</th> <th>MIN. PACK QUANTITY</th> </tr> </thead> <tbody> <tr> <td>MUSHROOM OPERATOR Ø60 TWIST TO RELEASE</td> <td>■</td> <td>PPFN1R6N</td> <td>50</td> <td>10</td> </tr> </tbody> </table>	TYPE	COLOUR INDEX	CODE	WEIGHT (gr)	MIN. PACK QUANTITY	MUSHROOM OPERATOR Ø60 TWIST TO RELEASE	■	PPFN1R6N	50	10	<table border="1"> <thead> <tr> <th>TYPE</th> <th>COLOUR INDEX</th> <th>CODE</th> <th>WEIGHT (gr)</th> <th>MIN. PACK QUANTITY</th> </tr> </thead> <tbody> <tr> <td>MUSHROOM OPERATOR WITH VISION Ø60 TWIST TO RELEASE</td> <td>■</td> <td>PPFN1R6S</td> <td>52</td> <td>10</td> </tr> </tbody> </table>	TYPE	COLOUR INDEX	CODE	WEIGHT (gr)	MIN. PACK QUANTITY	MUSHROOM OPERATOR WITH VISION Ø60 TWIST TO RELEASE	■	PPFN1R6S	52	10	<table border="1"> <thead> <tr> <th>TYPE</th> <th>COLOUR INDEX</th> <th>CODE</th> <th>WEIGHT (gr)</th> <th>MIN. PACK QUANTITY</th> </tr> </thead> <tbody> <tr> <td>MUSHROOM OPERATOR Ø60 TWIST TO RELEASE</td> <td>■</td> <td>PPFN1R6N</td> <td>50</td> <td>10</td> </tr> </tbody> </table>	TYPE	COLOUR INDEX	CODE	WEIGHT (gr)	MIN. PACK QUANTITY	MUSHROOM OPERATOR Ø60 TWIST TO RELEASE	■	PPFN1R6N	50	10	<table border="1"> <thead> <tr> <th>TYPE</th> <th>COLOUR INDEX</th> <th>CODE</th> <th>WEIGHT (gr)</th> <th>MIN. PACK QUANTITY</th> </tr> </thead> <tbody> <tr> <td>MUSHROOM OPERATOR WITH VISION Ø60 TWIST TO RELEASE</td> <td>■</td> <td>PPFN1R6S</td> <td>52</td> <td>10</td> </tr> </tbody> </table>	TYPE	COLOUR INDEX	CODE	WEIGHT (gr)	MIN. PACK QUANTITY	MUSHROOM OPERATOR WITH VISION Ø60 TWIST TO RELEASE	■	PPFN1R6S	52	10																										
TYPE	COLOUR INDEX	CODE	WEIGHT (gr)	MIN. PACK QUANTITY																																																																		
MUSHROOM OPERATOR Ø60 TWIST TO RELEASE	■	PPFN1R6N	50	10																																																																		
TYPE	COLOUR INDEX	CODE	WEIGHT (gr)	MIN. PACK QUANTITY																																																																		
MUSHROOM OPERATOR WITH VISION Ø60 TWIST TO RELEASE	■	PPFN1R6S	52	10																																																																		
TYPE	COLOUR INDEX	CODE	WEIGHT (gr)	MIN. PACK QUANTITY																																																																		
MUSHROOM OPERATOR Ø60 TWIST TO RELEASE	■	PPFN1R6N	50	10																																																																		
TYPE	COLOUR INDEX	CODE	WEIGHT (gr)	MIN. PACK QUANTITY																																																																		
MUSHROOM OPERATOR WITH VISION Ø60 TWIST TO RELEASE	■	PPFN1R6S	52	10																																																																		
	<table border="1"> <thead> <tr> <th>TYPE</th> <th>COLOUR INDEX</th> <th>CODE</th> <th>WEIGHT (gr)</th> <th>MIN. PACK QUANTITY</th> </tr> </thead> <tbody> <tr> <td>MUSHROOM OPERATOR Ø60 TWIST TO RELEASE</td> <td>■</td> <td>PPFN1R6N</td> <td>50</td> <td>10</td> </tr> </tbody> </table>	TYPE	COLOUR INDEX	CODE	WEIGHT (gr)	MIN. PACK QUANTITY	MUSHROOM OPERATOR Ø60 TWIST TO RELEASE	■	PPFN1R6N	50	10	<table border="1"> <thead> <tr> <th>TYPE</th> <th>COLOUR INDEX</th> <th>CODE</th> <th>WEIGHT (gr)</th> <th>MIN. PACK QUANTITY</th> </tr> </thead> <tbody> <tr> <td>MUSHROOM OPERATOR WITH VISION Ø60 TWIST TO RELEASE</td> <td>■</td> <td>PPFN1R6S</td> <td>52</td> <td>10</td> </tr> </tbody> </table>	TYPE	COLOUR INDEX	CODE	WEIGHT (gr)	MIN. PACK QUANTITY	MUSHROOM OPERATOR WITH VISION Ø60 TWIST TO RELEASE	■	PPFN1R6S	52	10	<table border="1"> <thead> <tr> <th>TYPE</th> <th>COLOUR INDEX</th> <th>CODE</th> <th>WEIGHT (gr)</th> <th>MIN. PACK QUANTITY</th> </tr> </thead> <tbody> <tr> <td>MUSHROOM OPERATOR Ø60 TWIST TO RELEASE</td> <td>■</td> <td>PPFN1R6N</td> <td>50</td> <td>10</td> </tr> </tbody> </table>	TYPE	COLOUR INDEX	CODE	WEIGHT (gr)	MIN. PACK QUANTITY	MUSHROOM OPERATOR Ø60 TWIST TO RELEASE	■	PPFN1R6N	50	10	<table border="1"> <thead> <tr> <th>TYPE</th> <th>COLOUR INDEX</th> <th>CODE</th> <th>WEIGHT (gr)</th> <th>MIN. PACK QUANTITY</th> </tr> </thead> <tbody> <tr> <td>MUSHROOM OPERATOR WITH VISION Ø60 TWIST TO RELEASE</td> <td>■</td> <td>PPFN1R6S</td> <td>52</td> <td>10</td> </tr> </tbody> </table>	TYPE	COLOUR INDEX	CODE	WEIGHT (gr)	MIN. PACK QUANTITY	MUSHROOM OPERATOR WITH VISION Ø60 TWIST TO RELEASE	■	PPFN1R6S	52	10																										
TYPE	COLOUR INDEX	CODE	WEIGHT (gr)	MIN. PACK QUANTITY																																																																		
MUSHROOM OPERATOR Ø60 TWIST TO RELEASE	■	PPFN1R6N	50	10																																																																		
TYPE	COLOUR INDEX	CODE	WEIGHT (gr)	MIN. PACK QUANTITY																																																																		
MUSHROOM OPERATOR WITH VISION Ø60 TWIST TO RELEASE	■	PPFN1R6S	52	10																																																																		
TYPE	COLOUR INDEX	CODE	WEIGHT (gr)	MIN. PACK QUANTITY																																																																		
MUSHROOM OPERATOR Ø60 TWIST TO RELEASE	■	PPFN1R6N	50	10																																																																		
TYPE	COLOUR INDEX	CODE	WEIGHT (gr)	MIN. PACK QUANTITY																																																																		
MUSHROOM OPERATOR WITH VISION Ø60 TWIST TO RELEASE	■	PPFN1R6S	52	10																																																																		
	<table border="1"> <thead> <tr> <th>TYPE</th> <th>COLOUR INDEX</th> <th>CODE</th> <th>WEIGHT (gr)</th> <th>MIN. PACK QUANTITY</th> </tr> </thead> <tbody> <tr> <td>MUSHROOM OPERATOR Ø60 TWIST TO RELEASE</td> <td>■</td> <td>PPFN1R6N</td> <td>50</td> <td>10</td> </tr> </tbody> </table>	TYPE	COLOUR INDEX	CODE	WEIGHT (gr)	MIN. PACK QUANTITY	MUSHROOM OPERATOR Ø60 TWIST TO RELEASE	■	PPFN1R6N	50	10	<table border="1"> <thead> <tr> <th>TYPE</th> <th>COLOUR INDEX</th> <th>CODE</th> <th>WEIGHT (gr)</th> <th>MIN. PACK QUANTITY</th> </tr> </thead> <tbody> <tr> <td>MUSHROOM OPERATOR WITH VISION Ø60 TWIST TO RELEASE</td> <td>■</td> <td>PPFN1R6S</td> <td>52</td> <td>10</td> </tr> </tbody> </table>	TYPE	COLOUR INDEX	CODE	WEIGHT (gr)	MIN. PACK QUANTITY	MUSHROOM OPERATOR WITH VISION Ø60 TWIST TO RELEASE	■	PPFN1R6S	52	10	<table border="1"> <thead> <tr> <th>TYPE</th> <th>COLOUR INDEX</th> <th>CODE</th> <th>WEIGHT (gr)</th> <th>MIN. PACK QUANTITY</th> </tr> </thead> <tbody> <tr> <td>MUSHROOM OPERATOR Ø60 TWIST TO RELEASE</td> <td>■</td> <td>PPFN1R6N</td> <td>50</td> <td>10</td> </tr> </tbody> </table>	TYPE	COLOUR INDEX	CODE	WEIGHT (gr)	MIN. PACK QUANTITY	MUSHROOM OPERATOR Ø60 TWIST TO RELEASE	■	PPFN1R6N	50	10	<table border="1"> <thead> <tr> <th>TYPE</th> <th>COLOUR INDEX</th> <th>CODE</th> <th>WEIGHT (gr)</th> <th>MIN. PACK QUANTITY</th> </tr> </thead> <tbody> <tr> <td>MUSHROOM OPERATOR WITH VISION Ø60 TWIST TO RELEASE</td> <td>■</td> <td>PPFN1R6S</td> <td>52</td> <td>10</td> </tr> </tbody> </table>	TYPE	COLOUR INDEX	CODE	WEIGHT (gr)	MIN. PACK QUANTITY	MUSHROOM OPERATOR WITH VISION Ø60 TWIST TO RELEASE	■	PPFN1R6S	52	10																										
TYPE	COLOUR INDEX	CODE	WEIGHT (gr)	MIN. PACK QUANTITY																																																																		
MUSHROOM OPERATOR Ø60 TWIST TO RELEASE	■	PPFN1R6N	50	10																																																																		
TYPE	COLOUR INDEX	CODE	WEIGHT (gr)	MIN. PACK QUANTITY																																																																		
MUSHROOM OPERATOR WITH VISION Ø60 TWIST TO RELEASE	■	PPFN1R6S	52	10																																																																		
TYPE	COLOUR INDEX	CODE	WEIGHT (gr)	MIN. PACK QUANTITY																																																																		
MUSHROOM OPERATOR Ø60 TWIST TO RELEASE	■	PPFN1R6N	50	10																																																																		
TYPE	COLOUR INDEX	CODE	WEIGHT (gr)	MIN. PACK QUANTITY																																																																		
MUSHROOM OPERATOR WITH VISION Ø60 TWIST TO RELEASE	■	PPFN1R6S	52	10																																																																		
	<table border="1"> <thead> <tr> <th>TYPE</th> <th>COLOUR INDEX</th> <th>CODE</th> <th>WEIGHT (gr)</th> <th>MIN. PACK QUANTITY</th> </tr> </thead> <tbody> <tr> <td>MUSHROOM OPERATOR Ø60 TWIST TO RELEASE</td> <td>■</td> <td>PPFN1R6N</td> <td>50</td> <td>10</td> </tr> </tbody> </table>	TYPE	COLOUR INDEX	CODE	WEIGHT (gr)	MIN. PACK QUANTITY	MUSHROOM OPERATOR Ø60 TWIST TO RELEASE	■	PPFN1R6N	50	10	<table border="1"> <thead> <tr> <th>TYPE</th> <th>COLOUR INDEX</th> <th>CODE</th> <th>WEIGHT (gr)</th> <th>MIN. PACK QUANTITY</th> </tr> </thead> <tbody> <tr> <td>MUSHROOM OPERATOR WITH VISION Ø60 TWIST TO RELEASE</td> <td>■</td> <td>PPFN1R6S</td> <td>52</td> <td>10</td> </tr> </tbody> </table>	TYPE	COLOUR INDEX	CODE	WEIGHT (gr)	MIN. PACK QUANTITY	MUSHROOM OPERATOR WITH VISION Ø60 TWIST TO RELEASE	■	PPFN1R6S	52	10	<table border="1"> <thead> <tr> <th>TYPE</th> <th>COLOUR INDEX</th> <th>CODE</th> <th>WEIGHT (gr)</th> <th>MIN. PACK QUANTITY</th> </tr> </thead> <tbody> <tr> <td>MUSHROOM OPERATOR Ø60 TWIST TO RELEASE</td> <td>■</td> <td>PPFN1R6N</td> <td>50</td> <td>10</td> </tr> </tbody> </table>	TYPE	COLOUR INDEX	CODE	WEIGHT (gr)	MIN. PACK QUANTITY	MUSHROOM OPERATOR Ø60 TWIST TO RELEASE	■	PPFN1R6N	50	10	<table border="1"> <thead> <tr> <th>TYPE</th> <th>COLOUR INDEX</th> <th>CODE</th> <th>WEIGHT (gr)</th> <th>MIN. PACK QUANTITY</th> </tr> </thead> <tbody> <tr> <td>MUSHROOM OPERATOR WITH VISION Ø60 TWIST TO RELEASE</td> <td>■</td> <td>PPFN1R6S</td> <td>52</td> <td>10</td> </tr> </tbody> </table>	TYPE	COLOUR INDEX	CODE	WEIGHT (gr)	MIN. PACK QUANTITY	MUSHROOM OPERATOR WITH VISION Ø60 TWIST TO RELEASE	■	PPFN1R6S	52	10																										
TYPE	COLOUR INDEX	CODE	WEIGHT (gr)	MIN. PACK QUANTITY																																																																		
MUSHROOM OPERATOR Ø60 TWIST TO RELEASE	■	PPFN1R6N	50	10																																																																		
TYPE	COLOUR INDEX	CODE	WEIGHT (gr)	MIN. PACK QUANTITY																																																																		
MUSHROOM OPERATOR WITH VISION Ø60 TWIST TO RELEASE	■	PPFN1R6S	52	10																																																																		
TYPE	COLOUR INDEX	CODE	WEIGHT (gr)	MIN. PACK QUANTITY																																																																		
MUSHROOM OPERATOR Ø60 TWIST TO RELEASE	■	PPFN1R6N	50	10																																																																		
TYPE	COLOUR INDEX	CODE	WEIGHT (gr)	MIN. PACK QUANTITY																																																																		
MUSHROOM OPERATOR WITH VISION Ø60 TWIST TO RELEASE	■	PPFN1R6S	52	10																																																																		



## AUXILIARY CONTROLS | PEGASUS SERIES

## EMERGENCY PUSH BUTTONS Ø22 | EN ISO 13850



TYPE	COLOUR INDEX	CODE	WEIGHT (gr)	MIN. PACK QUANTITY	SIZES
MUSHROOM OPERATOR Ø40 WITH KEY RELEASE	■	PPFN1C4NX (non EN ISO 13850)	76	10	



TYPE	COLOUR INDEX	CODE	WEIGHT (gr)	MIN. PACK QUANTITY	SIZES
MUSHROOM OPERATOR WITH VISION Ø40 PUSH-PULL	■	PPFN1P4N	44	10	



TYPE	COLOUR INDEX	CODE	WEIGHT (gr)	MIN. PACK QUANTITY	SIZES
MUSHROOM OPERATOR Ø40 PUSH-PULL WITH VISION	■	PPFN1P4S	46	10	



TYPE	COLOUR INDEX	CODE	WEIGHT (gr)	MIN. PACK QUANTITY	SIZES
MUSHROOM OPERATOR Ø40 PUSH-PULL WITH COLOUR CAP	■	PPFN1P4C	45	10	



TYPE	COLOUR INDEX	CODE	WEIGHT (gr)	MIN. PACK QUANTITY	SIZES
MUSHROOM OPERATOR Ø40 PUSH-PULL WITH LENS CAP	■	PPFL1P4N	45	10	

## TECNICAL NOTES

- All operators comply with the relevant European standard.
- EN ISO 13850: Machine safety - Emergency stop operators, functional characteristics - Design guidelines.
- IEC/EN6097-5-1.
- Comply with the standard IEC/EN60204-1: Machine safety - Machine electrical circuits - General guidelines.
- The push buttons are designed with a load charge mechanism to ensure a reliable operation and stoppage, or blockage, in the activate position. The combination with positive switching NC contacts and the presence of the "status" indicator on some models, guarantee a high degree of reliability and effectiveness.

### CONTACT BLOCKS | SPRING LOADED TERMINALS



DESIGNATION	FUNCTION	CODE	SIZES
	0 1,5 6 mm	PCW01	
	0 3,5 6 mm	PCW10	

### LAMPHOLDER BA9s



DESIGNATION	POWER SUPPLY	CODE	SIZES
	BA9s Lamp socket 250V 2,4 W max Bulb not included	PCWAD	

### LAMPHOLDER WITH BUILT-IN LED





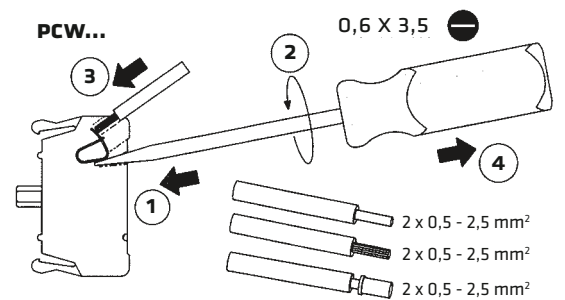
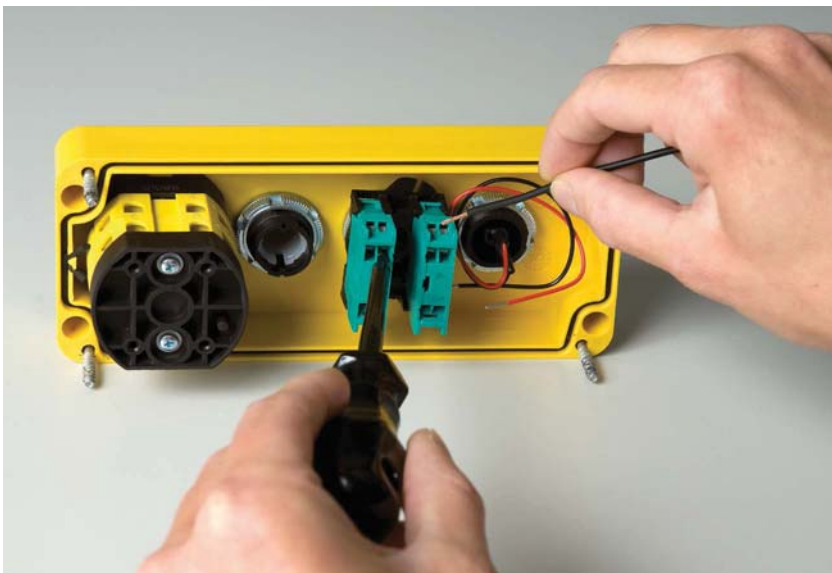

DESIGNATION	FUNCTION	CODE	SIZES
	AC/DC 12V	PCW5L12	
	AC/DC 24V	PCW5L24	
	AC/DC 48V	PCW5L48	
	AC/DC 110V	PCW5L110	
	AC 220V	PCW5L220	



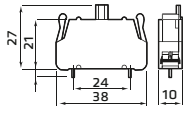

## AUXILIARY CONTROLS | PEGASUS SERIES



## CONTACT BLOCKS | WELDING TERMINALS

DESIGNATION	FUNCTION	CODE	SIZES
 1 — NC — 2	  0 1,5 6 mm	PSC01	
3 — NO — 4	 0 3,5 6 mm	PSC10	

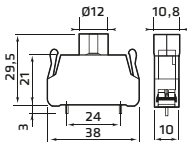
## LAMPHOLDER BA9s

DESIGNATION	POWER SUPPLY	CODE	SIZES
 X1 —  — X2	BA9s Lamp socket 250V 2,4 W max Bulb not included	PSCAD	

## LAMPHOLDER WITH BUILT-IN LED

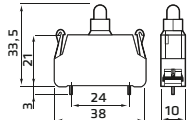
DESIGNATION	FUNCTION	CODE	SIZES
 X1 —  — X2	AC/DC 12V	PSC5L12	
	AC/DC 24V	PSC5L24	
	AC/DC 48V	PSC5L48	
	AC/DC 110V	PSC5L110	
	AC 220V	PSC5L220	

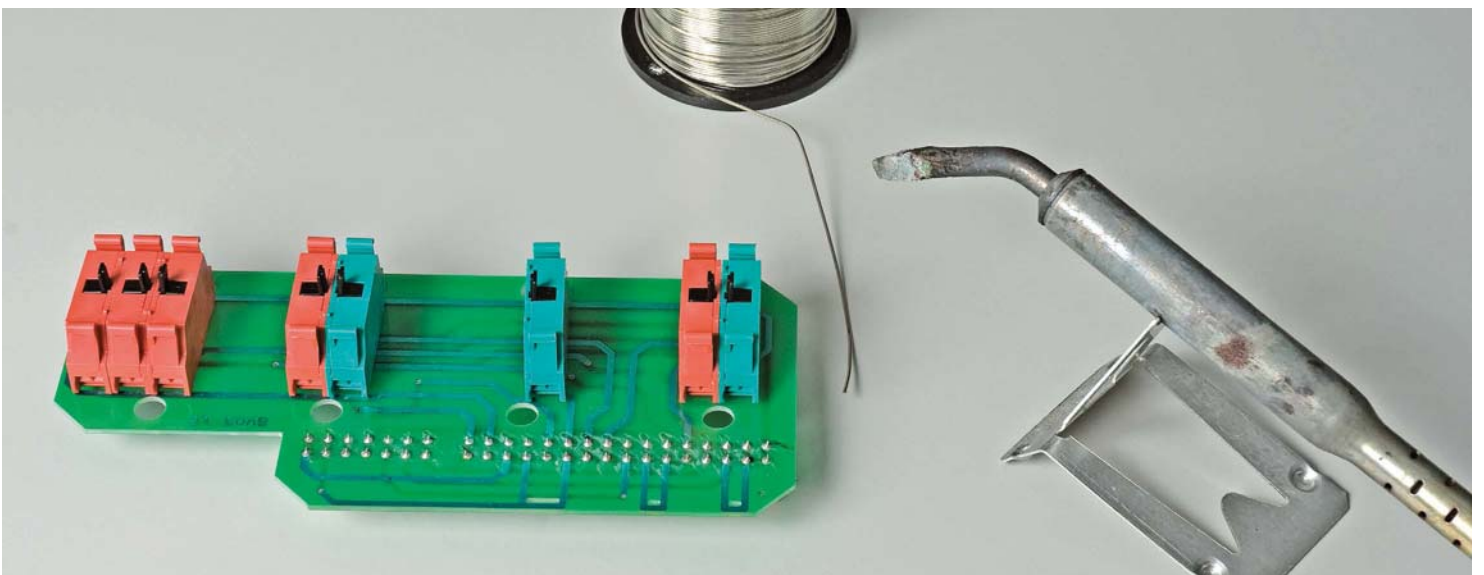

### CONTACT BLOCKS | SCREW TERMINALS

	DESIGNATION	FUNCTION	CODE	
			PL004001	
			PL004002	

### LAMPHOLDER BA9s

	DESIGNATION	POWER SUPPLY	CODE	
		BA9s Lamp socket 250V 2.4 W max Bulb not included	PL004007	

### LAMPHOLDER WITH BUILT-IN LED

	DESIGNATION	FUNCTION	CODE	
		AC/DC 12V	PL0045L12	
		AC/DC 24V	PL0045L24	
		AC/DC 48V	PL0045L48	
		AC/DC 110V	PL0045L110	
		AC 220V	PL0045L220	

## AUXILIARY CONTROLS | PEGASUS SERIES

## CONTROL STATION WITH MUSHROOM Ø90 | IP66

	<table border="1"> <thead> <tr> <th>TYPE</th> <th>COLOUR INDEX</th> <th>DESIGNATION</th> <th>CODE</th> <th>SIZES</th> </tr> </thead> <tbody> <tr> <td>MUSHROOM HEAD MOMENTARY</td> <td>■</td> <td></td> <td>PG1M9W01</td> <td></td> </tr> </tbody> </table>	TYPE	COLOUR INDEX	DESIGNATION	CODE	SIZES	MUSHROOM HEAD MOMENTARY	■		PG1M9W01	
TYPE	COLOUR INDEX	DESIGNATION	CODE	SIZES							
MUSHROOM HEAD MOMENTARY	■		PG1M9W01								
	<table border="1"> <thead> <tr> <th>TYPE</th> <th>COLOUR INDEX</th> <th>DESIGNATION</th> <th>CODE</th> <th>SIZES</th> </tr> </thead> <tbody> <tr> <td>MUSHROOM HEAD MOMENTARY</td> <td>■</td> <td></td> <td>PG8M9W10</td> <td></td> </tr> </tbody> </table>	TYPE	COLOUR INDEX	DESIGNATION	CODE	SIZES	MUSHROOM HEAD MOMENTARY	■		PG8M9W10	
TYPE	COLOUR INDEX	DESIGNATION	CODE	SIZES							
MUSHROOM HEAD MOMENTARY	■		PG8M9W10								
	<table border="1"> <thead> <tr> <th>TYPE</th> <th>COLOUR INDEX</th> <th>DESIGNATION</th> <th>CODE</th> <th>SIZES</th> </tr> </thead> <tbody> <tr> <td>MUSHROOM HEAD MOMENTARY FLUSH MOUNTING</td> <td>■</td> <td></td> <td>PR1M9W01</td> <td></td> </tr> </tbody> </table>	TYPE	COLOUR INDEX	DESIGNATION	CODE	SIZES	MUSHROOM HEAD MOMENTARY FLUSH MOUNTING	■		PR1M9W01	
TYPE	COLOUR INDEX	DESIGNATION	CODE	SIZES							
MUSHROOM HEAD MOMENTARY FLUSH MOUNTING	■		PR1M9W01								



## ELECTRICAL CHARACTERISTICS

- ⊕ Protection EN60529 IP66.
- ⊕ Double insulated.
- ⊕ Number contact capacity: max 3 contact blocks.
- ⊕ Cable entry with 3 holes Pg 13,5/M20.
- ⊕ Ambient temperature:
  - operating: -25 +70°C
  - storage: -30 +70°C
- ⊕ Climate protection: IEC 68 2-3, 2-30.
- ⊕ Terminals referencing: EN50013.
- ⊕ Colors:
  - Red mushroom;
  - Yellow cover;
  - Black box;
  
  - Black mushroom;
  - Grey cover;
  - Black box.









### PUSH BUTTON STATIONS | IP65

	<table border="1"> <thead> <tr> <th>TYPE</th> <th>COLOUR</th> <th>DESIGNATION</th> <th>CODE</th> <th>WEIGHT (gr)</th> <th>MIN. PACK</th> <th>SIZES</th> </tr> </thead> <tbody> <tr> <td rowspan="2">FLUSH PUSH BUTTON</td> <td>■</td> <td>1 ——— 2</td> <td>PQ01RN1</td> <td rowspan="2">176</td> <td rowspan="2">1</td> <td rowspan="2"> </td> </tr> <tr> <td>■</td> <td>3 ——— 4</td> <td>PQ01RN2</td> </tr> </tbody> </table>	TYPE	COLOUR	DESIGNATION	CODE	WEIGHT (gr)	MIN. PACK	SIZES	FLUSH PUSH BUTTON	■	1 ——— 2	PQ01RN1	176	1		■	3 ——— 4	PQ01RN2
TYPE	COLOUR	DESIGNATION	CODE	WEIGHT (gr)	MIN. PACK	SIZES												
FLUSH PUSH BUTTON	■	1 ——— 2	PQ01RN1	176	1													
	■	3 ——— 4	PQ01RN2															
	<table border="1"> <thead> <tr> <th>TYPE</th> <th>COLOUR</th> <th>DESIGNATION</th> <th>CODE</th> <th>WEIGHT (gr)</th> <th>MIN. PACK</th> <th>SIZES</th> </tr> </thead> <tbody> <tr> <td>EMERGENCY STOP Ø40 NOT LATCHING</td> <td>■</td> <td>1 ——— 2</td> <td>PQ01M4N</td> <td>192</td> <td>1</td> <td> </td> </tr> </tbody> </table>	TYPE	COLOUR	DESIGNATION	CODE	WEIGHT (gr)	MIN. PACK	SIZES	EMERGENCY STOP Ø40 NOT LATCHING	■	1 ——— 2	PQ01M4N	192	1				
TYPE	COLOUR	DESIGNATION	CODE	WEIGHT (gr)	MIN. PACK	SIZES												
EMERGENCY STOP Ø40 NOT LATCHING	■	1 ——— 2	PQ01M4N	192	1													
	<table border="1"> <thead> <tr> <th>TYPE</th> <th>COLOUR</th> <th>DESIGNATION</th> <th>CODE</th> <th>WEIGHT (gr)</th> <th>MIN. PACK</th> <th>SIZES</th> </tr> </thead> <tbody> <tr> <td>EMERGENCY STOP Ø60 NOT LATCHING</td> <td>■</td> <td>1 ——— 2</td> <td>PQ01M6N</td> <td>198</td> <td>1</td> <td> </td> </tr> </tbody> </table>	TYPE	COLOUR	DESIGNATION	CODE	WEIGHT (gr)	MIN. PACK	SIZES	EMERGENCY STOP Ø60 NOT LATCHING	■	1 ——— 2	PQ01M6N	198	1				
TYPE	COLOUR	DESIGNATION	CODE	WEIGHT (gr)	MIN. PACK	SIZES												
EMERGENCY STOP Ø60 NOT LATCHING	■	1 ——— 2	PQ01M6N	198	1													
	<table border="1"> <thead> <tr> <th>TYPE</th> <th>COLOUR</th> <th>DESIGNATION</th> <th>CODE</th> <th>WEIGHT (gr)</th> <th>MIN. PACK</th> <th>SIZES</th> </tr> </thead> <tbody> <tr> <td>WITH NR. 2 PUSH BUTTONS</td> <td>   </td> <td>           3 ——— 4            3 ——— 4         </td> <td>PQ02B</td> <td>264</td> <td>1</td> <td> </td> </tr> </tbody> </table>	TYPE	COLOUR	DESIGNATION	CODE	WEIGHT (gr)	MIN. PACK	SIZES	WITH NR. 2 PUSH BUTTONS	 	3 ——— 4 3 ——— 4	PQ02B	264	1				
TYPE	COLOUR	DESIGNATION	CODE	WEIGHT (gr)	MIN. PACK	SIZES												
WITH NR. 2 PUSH BUTTONS	 	3 ——— 4 3 ——— 4	PQ02B	264	1													
	<table border="1"> <thead> <tr> <th>TYPE</th> <th>COLOUR</th> <th>DESIGNATION</th> <th>CODE</th> <th>WEIGHT (gr)</th> <th>MIN. PACK</th> <th>SIZES</th> </tr> </thead> <tbody> <tr> <td>WITH NR. 1 PUSH BUTTONS AND NR. 1 EMERGENCY EN ISO 13850</td> <td>   </td> <td>           3 ——— 4            1 ——— 2         </td> <td>PQ02A</td> <td>264</td> <td>1</td> <td> </td> </tr> </tbody> </table>	TYPE	COLOUR	DESIGNATION	CODE	WEIGHT (gr)	MIN. PACK	SIZES	WITH NR. 1 PUSH BUTTONS AND NR. 1 EMERGENCY EN ISO 13850	 	3 ——— 4 1 ——— 2	PQ02A	264	1				
TYPE	COLOUR	DESIGNATION	CODE	WEIGHT (gr)	MIN. PACK	SIZES												
WITH NR. 1 PUSH BUTTONS AND NR. 1 EMERGENCY EN ISO 13850	 	3 ——— 4 1 ——— 2	PQ02A	264	1													
	<table border="1"> <thead> <tr> <th>TYPE</th> <th>COLOUR</th> <th>DESIGNATION</th> <th>CODE</th> <th>WEIGHT (gr)</th> <th>MIN. PACK</th> <th>SIZES</th> </tr> </thead> <tbody> <tr> <td>WITH NR. 2 PUSH BUTTONS AND NR. 1 EMERGENCY EN ISO 13850</td> <td>     </td> <td>           3 ——— 4            1 ——— 2            3 ——— 4         </td> <td>PQ03B</td> <td>362</td> <td>1</td> <td> </td> </tr> </tbody> </table>	TYPE	COLOUR	DESIGNATION	CODE	WEIGHT (gr)	MIN. PACK	SIZES	WITH NR. 2 PUSH BUTTONS AND NR. 1 EMERGENCY EN ISO 13850	  	3 ——— 4 1 ——— 2 3 ——— 4	PQ03B	362	1				
TYPE	COLOUR	DESIGNATION	CODE	WEIGHT (gr)	MIN. PACK	SIZES												
WITH NR. 2 PUSH BUTTONS AND NR. 1 EMERGENCY EN ISO 13850	  	3 ——— 4 1 ——— 2 3 ——— 4	PQ03B	362	1													

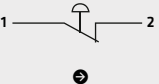
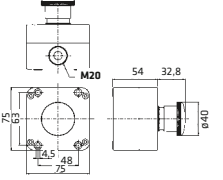

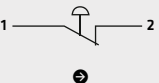
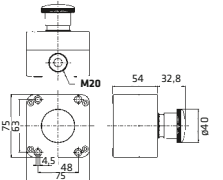
## AUXILIARY CONTROLS | PEGASUS SERIES

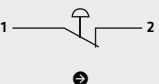
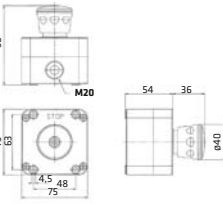
## PUSH BUTTON STATIONS | EN ISO 13850 IP65

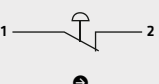
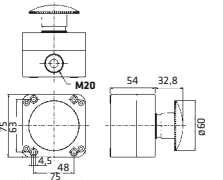
	TYPE	COLOUR	DESIGNATION	CODE	WEIGHT (gr)	MIN. PACK	SIZES
	EMERGENCY STOP Ø40 TWIST TO RELEASE	■	1  2 ⊕	PQ01R4N	190	1	
	EMERGENCY STOP Ø40 PUSH-PULL	■	1  2 ⊕	PQ01P4N	192	1	
	EMERGENCY STOP PUSH BUTTON Ø40 PUSH-PULL WITH VISION	■	1  2 ⊕	PQ01P4L 1	190	1	
	EMERGENCY STOP Ø60 PUSH-PULL	■	1  2 ⊕	PQ01P6N	198	1	

## TECNICAL NOTES

- ⊕ All operators comply with the relevant European standard.
- ⊕ EN ISO 13850: Machine safety - Emergency stop operators, functional characteristics - Design guidelines.
- ⊕ IEC/EN6097-5-1.
- ⊕ Comply with the standard IEC/EN60204-1: Machine safety - Machine electrical circuits - General guidelines.
- ⊕ The push buttons are designed with a load charge mechanism to ensure a reliable operation and stoppage, or blockage, in the activate position. The combination with positive switching NC ⊕ contacts and the presence of the "status" indicator on some models, guarantee a high degree of reliability and effectiveness.

### PUSH BUTTON STATION ENCLOSURES | IP65



TYPE	COVER COLOUR	CODE	WEIGHT (gr)	MIN. PACK QUANTITY	SIZES
1 HOLES ENCLOSURE	■	PQ01K	134	1	
	■	PQ01KGN			



TYPE	COVER COLOUR	CODE	WEIGHT (gr)	MIN. PACK QUANTITY	SIZES
2 HOLES ENCLOSURE	■	PQ02K	174	1	
	■	PQ02KGN			



TYPE	COVER COLOUR	CODE	WEIGHT (gr)	MIN. PACK QUANTITY	SIZES
3 HOLES ENCLOSURE	■	PQ03K	214	1	
	■	PQ03KGN			



TYPE	COVER COLOUR	CODE	WEIGHT (gr)	MIN. PACK QUANTITY	SIZES
4 HOLES ENCLOSURE	■	PQ04K	256	1	
	■	PQ04KGN			

## AUXILIARY CONTROLS | PEGASUS SERIES

## PUSH BUTTON STATION ENCLOSURES | IP65



TYPE	COVER COLOUR	CODE	WEIGHT (gr)	MIN. PACK QUANTITY	SIZES
5 HOLES ENCLOSURE	■	PQ05K	296	1	
	■	PQ05KGN			

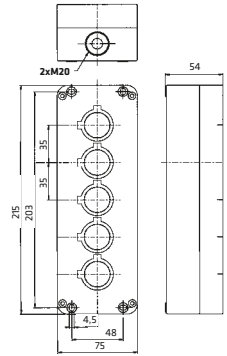

TYPE	COVER COLOUR	CODE	WEIGHT (gr)	MIN. PACK QUANTITY	SIZES
3 HOLES ENCLOSURE	■	PQ06K	386	1	
	■	PQ06KGN			

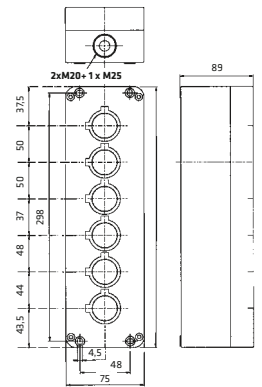

## CHARACTERISTICS

- ABS self-extinguishing material.
- Self-extinguishing class V0 UL94.
- EN60529 IP65 protection grade.
- Double insulation .

- Colors: Black box RAL 9005; Yellow cover PANTONE 102C; Grey cover RAL 7035.

- Threaded cable entry with membrane conduit knock:

- 1 hole box nr. 1 M16 + 1 M20 gland, from 2 to 5 holes nr. 2 M20 glands;
- 6 holes nr. 1 M20 + 1 M25 glands

## ASSEMBLING

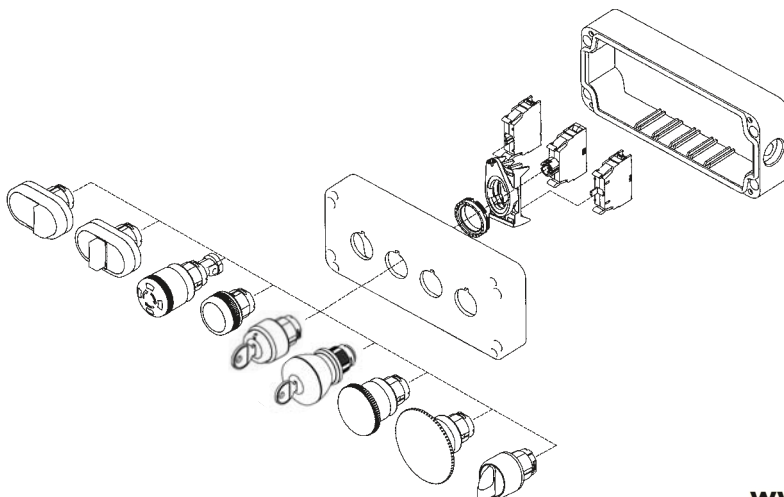

### ACCESSORIES

#### DIN RAIL MOUNTING ADAPTOR



DESCRIPTION	CODE
DIN EN50022 RAIL MOUNTING FOR 46 MM STANDARDISED ENCLOSURES GREY RAL 7035	11708351

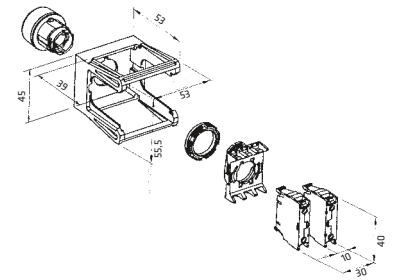

#### PROTECTION CAPS

##### FOR FLUSH BUTTON

DESCRIPTION	CODE
PEGASUS	PCR



##### FOR MULTIFUNCTIONAL SERIES

PEGASUS	CODE
PPDN-PPDL	PCD
PPMN	PCM
PPDNR-PPDLR	PCN



##### FOR EXTENDED PUSH BUTTON

DESCRIPTION	CODE
PEGASUS	PCS



#### CENTRAL CONTACT OPERATION



DESCRIPTION	CODE
FOR PUSH BUTTONS STABLE-UNSTABLE	PAC

#### KEY FIXING BULB EXTRACTOR



CODE
PCF

#### STOPPER CLOSING HOLES Ø22,5



CODE
PTRN8

#### CONTACTS SUPPORT



DESCRIPTION	CODE
TO CONTACT ELEMENTS PL, PCW, PSC	PPELN8

DESCRIPTION	CODE
TO FIVE CONTACT ELEMENTS PL, PCW, PSC	PPELN8-5

#### FASTON CONNECTORS AND FOR PCB



DESCRIPTION	CODE
FASTON 6,3x0,8	11708341

DESCRIPTION	CODE
PCB	11708235

TO SCREW CONTACTS PL

## AUXILIARY CONTROLS | PEGASUS SERIES

## OPERATOR CAPS Ø22

## MOMENTARY AND LATCHED, FLUSH PUSH BUTTONS



SYMBOL	COLOUR	CODE
	■	PPRN2/I
	■	PPRN1/O
	■	PPRN2/II
	■	PPRN2/START
	■	PPRN1/STOP

SYMBOL	COLOUR	CODE
	■	PPRN2/ON
	■	PPRN1/OFF
	■	PPRN5/F
	■	PPRN8/F

Available others symbols on request, also in different languages and colours.

## EMERGENCY STOP RING

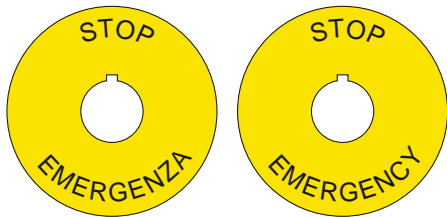

DESCRIPTION	TEXT	CODE
Ø60 Made of Aluminium Yellow background Black letters. Weight 3,5 gr. Min. packing q.ty 10 pcs.	BLANK	PTE
	STOP - EMERGENZA	PTE/I
	EMERGENCY - STOP	PTE/A
	NOT - AUS	PTE/D

Available others texts on request, also in different languages.

## LEGEND PLATE



CODE
PPTN8

## LABEL



TEXT	CODE
(Blank)	PTA00
MARCIA	PTA01
ARRESTO	PTA02
I O II	PTA03
O I	PTA04
CHIUDE	PTA05
APRE	PTA06
EMERGENZA	PTA07
MANUALE	PTA08
AUTOMATICO	PTA09
AVANTI	PTA10
INDIETRO	PTA11
EIN	PTA12
AUS	PTA13
STOP	PTA14
START	PTA15
RESET	PTA16
I → 0 ← II	PTA17
AUT 0 MAN	PTA18
INS - DISINS	PTA26
HAND OFF AUTO	PTA27
FORW OFF REV	PTA28
ON OFF	PTA29



**TECHNICAL DATA | ELECTRICAL CHARACTERISTICS**

**CONTACT BLOCKS**

EC/EN 60947-5-1 CHARACTERISTICS		PLO04001-PLO04002	PCW01-PCW10 / PSC01-PSC10
Rated insulation voltage Ui	V	690*	690*
Rated impulse withstand voltage Uimp	kV	4*	4*
Operating frequency	Hz	50/60*	50/60*
Rated thermal current Ith	A	16*	16*
Rated thermal current in enclosed Ithe	Hz	10*	10*

RATED OPERATING CURRENT Ie:		PLO04001-PLO04002	PCW01-PCW10 / PSC01-PSC10
AC15: Alternate current	V	24 60 110 230 400 440 500 690	24 60 110 240 400 440 500 690
	A	16* 12 8 6 4,5 3,5 1* 1	16* 12 5 5* 4 4 4* 2*
DC13: Direct current	V	24 48 60 110 220	24 48 60 110 250
	A	2* 1,2 0,85 0,4 0,25*	2 2* 1* 0,4 0,4*
Conditional short circuit withstand current	A	1000*	1000*
Fuse rating gG	500V	10A*	10A*
Contact insulation resistance	mΩ	<25	<25
Switching mechanism		Slow break double gap contacts	Slow break double gap contacts
Contact duty		☉ NC contact with positive opening	☉ NC contact with positive opening
Minimum tripping force		4N	4N
Electrical life AC15	mil. cycles	1A/1,5 - 2A/0,5 - 3A/0,25	1A/1,5 - 2A/0,5 - 3A/0,25

UL 508 CHARACTERISTICS		PLO04001-PLO04002	PCW01-PCW10 / PSC01-PSC10
General Use		10A-600V ac - 2,5A-125V dc	10A-600V ac - 2,5A-125V dc
Heavy Duty (HD) category		A600-Q600	A600-Q600

**LAMP HOLDER**

		BA9s	BUILT-IN LED
EC/EN 60947-5-1 CHARACTERISTICS		DIRECT PLO04007 PCWAD-PSCAD	LED PLO04.L. PCW.L.-PSC.L.
Rated insulation voltage Ui	V	690*	400
Rated operating voltage Ue	V	400* 300 1	AC/DC 12-24
	V	-	AC/DC 48
	V	-	AC/DC 110
	V	-	AC 220
	V	-	-
Max rated power	W	2,4* 2,5 1	-
Power supply		AC/DC	-
Lamp fixing system		BA9s	-



## AUXILIARY CONTROLS | PEGASUS SERIES

## TECHNICAL DATA | ELECTRICAL CHARACTERISTICS

STANDARD CONFORMITY		UL - IMG - CCC - EAC - R.I.NA
Approvals		IEC/EN60947-5-1, UL508
Protection class	<b>EN 60529</b>	IP65: Buttons and switches, joysticks, single-lamp IP66/IP67/IP69K: Mushroom emergency EN ISO 13850
	<b>Conforms to UL50</b>	IP40: Multi-function push buttons
	<b>EN 60529</b>	IP66: Buttons with protection caps Type 1
		IP65: Control stations, enclosures
		IP66: Mushroom, Push button Ø90
		IP20: Contacts PCW.,PL.
		IP00:PSC.
Material Group	<b>EN60947-1</b>	II
Pollution Grade	<b>EN60947-1</b>	3
Flammability	<b>UL94</b>	VO: live parts
Ambient Temperature	°C	Operating: -25 +70
	°C	Storage: -30 +70
Climate Protection	<b>IEC68 part 2-3</b>	Hot damp
	<b>IEC68 part 2-30</b>	Unsettled Hot damp
Terminals referencing		EN50013
<b>Terminals:</b>		
Dimensions		A2
Screw		M3,5
Torque		1,2 Nm - EN60947-1 - 12 lb.in. UL508
<b>Capacity:</b>		
Solid and flexible conductors	<b>n° 1 min/max mm²</b>	1/2,5 screw terminals, 0,5-2,5 spring loaded terminals
	<b>n° 2 min/max mm²</b>	1/2,5 screw terminals, 0,5-2,5 spring loaded terminals
	<b>AWG</b>	20-12 screw terminals, spring loaded terminals
<b>Mechanical life:</b>		
Mushroom operators and standard		3
Push buttons with colour cap	<b>mil./operations</b>	
Standard push buttons with lens cap		1
Latched push buttons with colour cap		1
Standard rotary switches		1
Rotary switches with lens, latched push button with lens cap, joystick		0,5
Emergency stop push buttons with release		0,3

**ASSEMBLY INSTRUCTIONS**

**ASSEMBLY**

- Modular.
- Holes according to IEC/EN 60947-5-1, CENELEC EN50007.

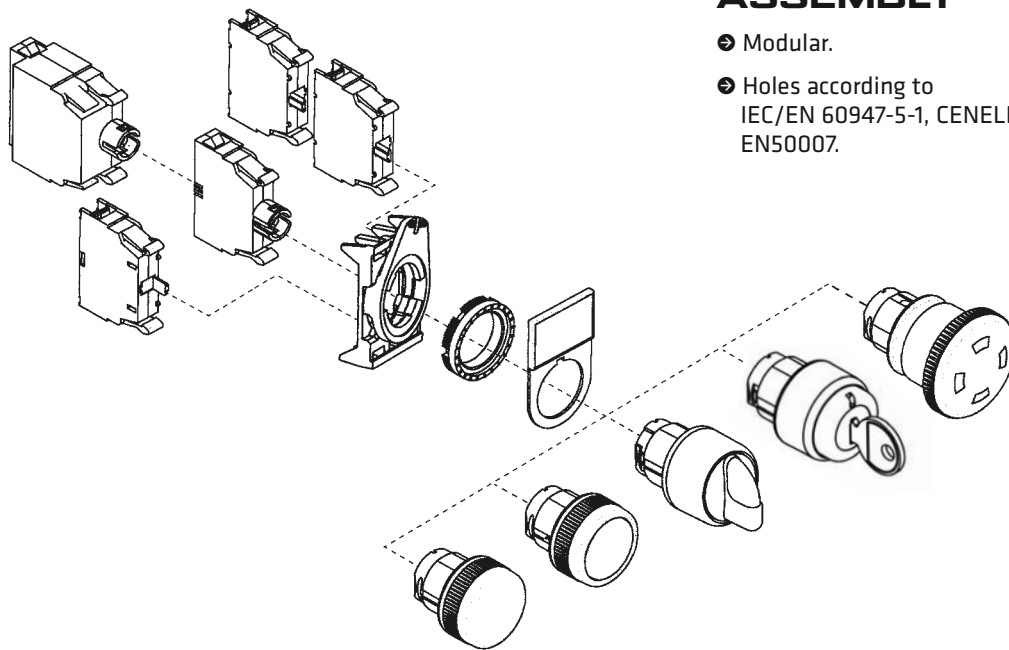

**CENELEC EN50007**

- Panel thickness from 1 up to 6 mm.

➤ If not required, lock nuts can be easily removed by means of a screwdriver.

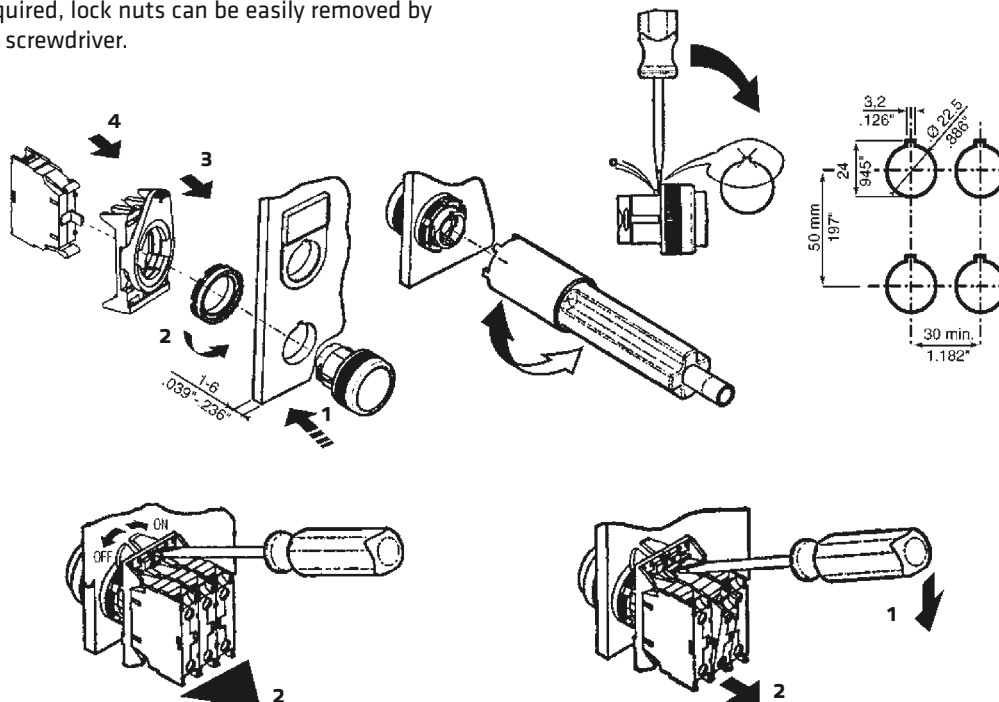





**GIOVENZANA**  
INTERNATIONAL B.V.