



7

Charging technology for electromobility

2019/2020



Terminal blocks

- Terminal blocks

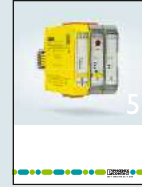

Interface technology and switching devices

- Electronic switching devices and motor control
- Measurement and control technology
- Monitoring
- Relay modules
- System cabling for controllers



Sensor/actuator cabling and connectors

- Sensor/actuator cabling
- Cables and lines
- Connectors



Automation

- PLCnext Technology
- Industrial cloud computing
- Software
- PLCs and I/O systems
- Functional safety
- Industrial communication technology
- HMIs and industrial PCs
- Lighting and signaling



Marking systems, tools, and mounting material

- Marking and labeling
- Tools
- Installation and mounting material



Charging technology for electromobility

- Charging technology for electromobility



Surge protection, power supplies, and device circuit breakers

- Surge protection and interference suppression filters
- Power supplies and UPS
- Protective devices



PCB terminal blocks and PCB connectors

Use our E-paper for quick product selection.

i Web code: #1517

Find out more with the web code

For detailed information, use the web codes provided in this brochure. Simply enter # and the four-digit number in the search field on our website.

i Web code: #1234 (example)

Or use the direct link:

phoenixcontact.net/webcode/#1234

You will find the latest information including all the new products directly in the product area of our website:

phoenixcontact.net/products

You can also use the Phoenix Contact catalog app interactively on your tablet.



Table of contents

Illustrated product range overview

4

Access the right product more quickly from here

Charging connection systems

6



Charging controllers

54



Charging technology sets

68



Charging park management software

72



Technical information

78

Index

80

Charging technology for electromobility

Illustrated product range overview

Charging connection systems



DC charging cables

Page 12



Cooled DC charging cables

Page 16



Repair kits for DC charging cables

Page 40



Holders for DC charging cables

Page 42



AC charging cables with one free cable end

Page 20



Mobile AC charging cables

Page 28



AC adapter charging cables

Page 32



Holders for AC charging cables

Page 44



AC infrastructure socket outlets

Page 36



Protective covers for AC infrastructure socket outlets

Page 46



Vehicle inlets

Page 50

Charging controllers



DC charging controllers for public and commercial applications

Page 57



AC charging controllers for public and commercial applications

Page 60



AC charging controllers for private applications

Page 62



Residual current monitoring for AC charging controllers

Page 67

Charging technology sets



AC charging technology sets for private applications

Page 70



AC charging technology sets for commercial applications

Page 71

Charging park management software



Software suite for charging park management

Page 76

Further products for constructing charging stations and wall boxes

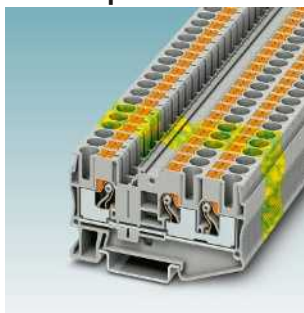

Terminal blocks
See Catalog 1

i Your web code: [#0567](#)

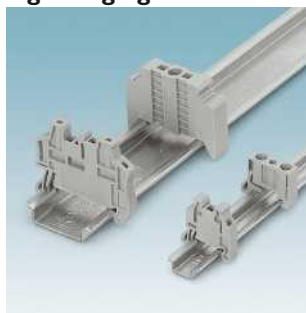

Installation material
See Catalog 3

i Your web code: [#0094](#)



Power supplies
See Catalog 4

i Your web code: [#1930](#)



Surge protection
See Catalog 4

i Your web code: [#2105](#)



Energy meters
See Catalog 5

i Your web code: [#1267](#)



Communication technology
See Catalog 6

i Your web code: [#0936](#)



Operating panels
See Catalog 6

i Your web code: [#2104](#)



Charging connection systems

Our charging connection systems set the standard when it comes to supplying energy to electric vehicles.

Thanks to silver-plated power and signal contacts, high-precision temperature monitoring, and the integrated locking system, our charging cables, socket outlets, and vehicle inlets are safe and reliable in operation. Thanks to their attractive, ergonomic design, they are easy and comfortable to use.

With our High Power Charging technology, we are setting yet another milestone in the history of electromobility by reducing charging time to just a few minutes.

The broad product range takes the three most important charging standards into consideration for all applications worldwide:

- Type 1 for North America and Japan
- Type 2 for Europe and other countries
- GB/T for China

i Your web code: [#2073](#)

Global portfolio with charging types and charging modes	8
DC charging cables	10
DC charging cables – High Power Charging (HPC)	14
AC charging cables	18
AC infrastructure socket outlets	34
Accessories	38
Vehicle inlets	48

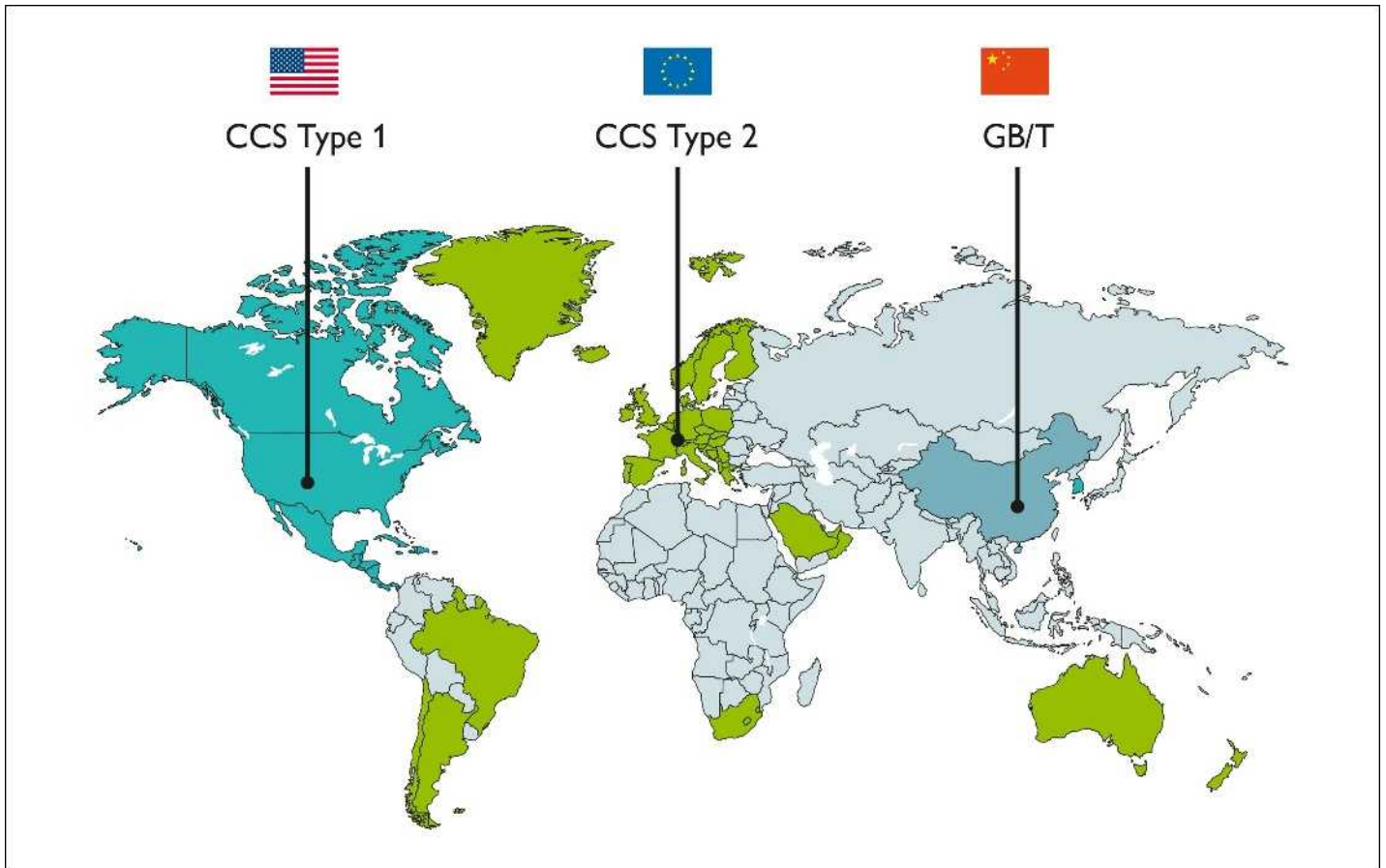

Various charging standards, which originated in North America, Europe, and China and have their own specific connector geometries, have become established throughout the world.

We can provide you with the complete range of charging cables and vehicle inlets for any region from a single source – both for conventional charging on the alternating current (AC) power grid and for fast charging with direct current (DC).

Thanks to our involvement in developing the Combined Charging System (CCS), AC and DC charging with just one vehicle inlet is now possible throughout most of the world.

Thanks to the common geometry of their mating faces, both AC and DC charging connectors fit into the same vehicle inlet. Therefore, automobile manufacturers only have to design one inlet for their vehicles. Furthermore, the charging process itself is easier for the driver to handle.

The system is also incredibly safe, thanks to the electromechanical locking system on the charging connector and the integrated, high-precision temperature monitoring function.

Along with the charging standards, the IEC 61851 standard also defines four different charging modes. Here, charging modes 1 to 3 only apply to AC charging, with charging mode 3 being further subdivided into charging cases A, B, and C. Charging mode 4 describes DC charging.

The charging modes covered by the Phoenix Contact product portfolio are illustrated to the right.

i Your web code: #2110



CCS type 1

The type 1 version of the Combined Charging System in accordance with SAE J1772 and IEC 62196-3 is used in North America, and is also becoming popular in South Korea. The mating faces of the AC and DC charging connectors are identical on the AC side and therefore fit into the same CCS vehicle inlet.



CCS type 2

The type 2 version of the Combined Charging System in accordance with IEC 62196-3 was specified by the European Commission as a uniform standard throughout Europe in 2013. In the meantime, this standard has also become established in Greenland, South America, South Africa, Saudi Arabia, and Australia. The mating faces of the AC and DC charging connectors are identical on the AC side and therefore fit into the same CCS vehicle inlet.



GB/T

The GB/T 20234 charging standard is only used in China. AC and DC charging connectors have different mating faces, meaning that separate AC and DC inlets are required in the vehicle.

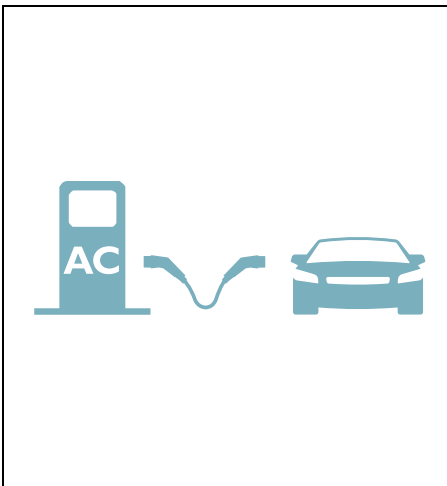

Charging mode 3, case B

In charging mode 3, the vehicle is charged with AC at a charging station or wall box. Charging case B requires a mobile AC charging cable that has a connector at both ends: one end is equipped with vehicle charging connector that plugs into the vehicle inlet. The other end is equipped with infrastructure charging plug and plugs into the charging outlet on the charging station.

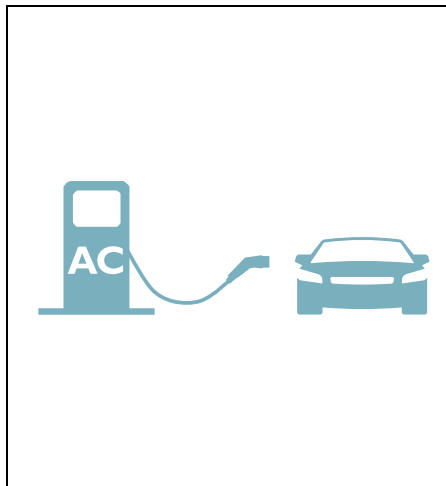

Charging mode 3, case C

In charging mode C, a charging cable that is permanently connected to the charging station is used. The charging cable therefore only has a connector at one end – the vehicle charging connector that plugs into the vehicle inlet.

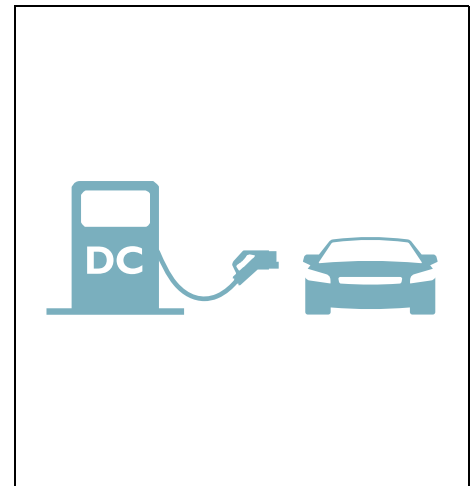

Charging mode 4

This charging mode describes direct current (DC) charging. Increased safety requirements apply due to the particularly high charging power involved. Therefore, with this mode, only a charging cable that is permanently connected to the charging station is used – a plug-in connection is only equipped on the vehicle side.



Short charging stops, thanks to high power transmission

The development of a widespread charging infrastructure for electric vehicles in conjunction with renewable energy is an important step toward a mobile future. The focus here is on integrating the charging process into everyday life. Situations involving short stops to charge, for example at rest stops en route, require a charging infrastructure with high power transmission and reliable safety mechanisms. In comparison with AC charging, DC charging enables a significantly higher power transmission, and is therefore the ideal solution for short charging stops during long journeys.

Powerful charging cables

We provide a comprehensive range of powerful and standard-compliant charging cables for global fast DC charging. The DC charging cables have a free cable end so that they can be connected permanently to the charging station in accordance with charging mode 4. Depending on the charging standard, powers of up to 250 kW are supported. The integrated sensors enable precise temperature monitoring, thereby guaranteeing a safe charging process.

Your advantages

- Comprehensive product range for CCS type 1, CCS type 2, and GB/T
- Efficient power transmission and long-term stability, thanks to silver-plated power and signal contacts
- Integrated sensor technology for monitoring the temperature at the power contacts
- Convenient handling, thanks to the ergonomic handle and additional rubber grip components
- Developed and produced in accordance with the IATF 16949 automotive standard and ISO 9001

i Your web code: [#2099](#)



CCS type 1

CCS type 1 charging cables in accordance with SAE J1772 and IEC 62196-3 allow for fast DC charging in North American and other AWG charging infrastructures. They are equipped with UL-certified AWG cables and a lever locking mechanism for locking. If the lever is actuated during the charging process, communication takes place to interrupt the power between the vehicle and charging station.



CCS type 2

In 2013, CCS type 2 charging cables in accordance with IEC 62196-3 marked an important milestone in European fast-charging technology. During the charging process, the charging cables lock electromechanically with a bolt that can withstand high pull-out forces by means of a locking actuator integrated into the vehicle inlet. The cables are metric and VDE-certified.



GB/T

DC charging cables in accordance with GB/T 20234.3-2015 are used for fast charging in the Chinese charging infrastructure. In addition to metric cables, they include a unique locking mechanism developed by Phoenix Contact that is integrated into the vehicle charging connector. The locking mechanism, which is controlled by the charging station, prevents the lever on the vehicle charging connector from being actuated during the charging process.

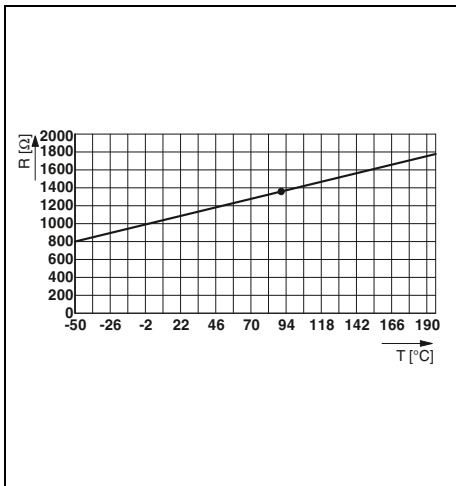

High-precision temperature measuring

The integrated temperature sensors in the vehicle charging connector send a pulse to the charging station to switch off the charging current in the event of a fault (e.g. in the event of soiling) in good time.



Secure locking during charging

Fast charging technology involves the transmission of high charging currents. It is therefore essential to safeguard against disconnection under load during the charging process. The vehicle charging connectors are protected with highly efficient locking mechanisms.



Secure hold between charging processes

Matching holders for DC charging cables are mounted on the outside of the charging station or wall box. They ensure the vehicle charging connector is held securely in place and protected from the elements whenever charging is not taking place. The holders are listed in the "Accessories" section.

Charging connection systems

DC charging cables

CCS type 2

- Charging in just a few minutes
- Charging cables for European charging infrastructure

Notes:
Upon request, we can also supply charging connectors with your company logo, as well as further cable types and lengths.



With a metric cable



With a metric cable

	Technical data		Technical data		Technical data	
	80 A	150 A	200 A			
Rated voltage	1000 V DC	1000 V DC	1000 V DC			
Rated current	80 A	150 A	200 A			
Standards	IEC 62196-3	IEC 62196-3	IEC 62196-3			
Charging mode	Mode 4	Mode 4	Mode 4			
Resistor coding	1500 Ω (between PE and PP)	1500 Ω (between PE and PP)	1500 Ω (between PE and PP)			
Ambient temperature (operation)	-30°C ... 50°C	-30°C ... 50°C	-30°C ... 50°C			
Number of power contacts	3 (PE, DC+, DC-)	3 (PE, DC+, DC-)	3 (PE, DC+, DC-)			
Insertion/withdrawal cycles	> 10,000	> 10,000	> 10,000			
Insertion/withdrawal force	< 100 N	< 100 N	< 100 N			
Temperature sensor	Pt 1000	Pt 1000	Pt 1000			
Degree of protection (when plugged in)	IP44	IP44	IP44			
Cable data						
Cable type	straight	straight	straight			
Cable length	5 m	5 m	5 m			
Cable diameter	18.4 mm ±0.3 mm	25.9 mm ±0.4 mm	28.1 mm ±0.2 mm			
Cable structure	3 x 16 mm ² + 3 x 2 x 0.75 mm ²	2 x 35 mm ² + 1 x 25 mm ² + 3 x 2 x 0.75 mm ²	2 x 50 mm ² + 1 x 25 mm ² + 3 x 2 x 0.75 mm ²			
Sheath color	black	black	black			
Ordering data						
Description	Order No.	Pcs./Pkt.	Order No.	Pcs./Pkt.	Order No.	Pcs./Pkt.
	80 A		150 A		200 A	
DC charging cable with open cable end, Combined Charging System (CCS)	1095764	1	1095767	1	1095775	1
Accessories						
Description	Type	Order No.	Pcs./Pkt.	Type	Order No.	Pcs./Pkt.
	EV-T2CCS-PARK	1624153	1	EV-T2CCS-PARK	1624153	1

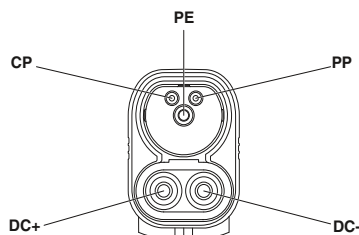

Vehicle charging connector pin assignment

GB/T

- Charging in just a few minutes
- Charging cables for the Chinese charging infrastructure
- Vehicle charging connectors with integrated locking and a protective cap

Notes:
Upon request, we can also supply charging connectors with your company logo, as well as further cable types and lengths.



GB/T DC vehicle charging connector, with a metric cable



GB/T DC vehicle charging connector, with a metric cable

	Technical data		Technical data	
	80 A	125 A	180 A	250 A
Rated voltage	1000 V DC	1000 V DC	1000 V DC	1000 V DC
Rated current	80 A	125 A	180 A	250 A
Standards	GB/T 20234.1-2015, GB/T 20234.3-2015	GB/T 20234.1-2015, GB/T 20234.3-2015	GB/T 20234.1-2015, GB/T 20234.3-2015	GB/T 20234.1-2015, GB/T 20234.3-2015
Charging mode	Mode 4	Mode 4	Mode 4	Mode 4
Resistor coding	1000 Ω (between PE and CC1 / PE and CC2)	1000 Ω (between PE and CC1 / PE and CC2)	1000 Ω (between PE and CC1 / PE and CC2)	1000 Ω (between PE and CC1 / PE and CC2)
Ambient temperature (operation)	-30°C ... 50°C	-30°C ... 50°C	-30°C ... 50°C	-30°C ... 50°C
Number of power contacts	3 (PE, DC+, DC-)	3 (PE, DC+, DC-)	3 (PE, DC+, DC-)	3 (PE, DC+, DC-)
Insertion/withdrawal cycles	> 10,000	> 10,000	> 10,000	> 10,000
Insertion/withdrawal force	< 100 N	< 100 N	< 100 N	< 100 N
Temperature sensor	Pt 1000	Pt 1000	Pt 1000	Pt 1000
Degree of protection (when plugged in)	IP55	IP55	IP55	IP55
Degree of protection (with protective cap)	IP54	IP54	IP54	IP54
Cable data				
Cable type	straight	straight	straight	straight
Cable length	5 m	5 m	5 m	5 m
Cable diameter	27 mm ±0.4 mm	31.6 mm ±0.4 mm	33.1 mm ±0.4 mm	34.9 mm ±0.4 mm
Cable structure	3 x 16 mm ² + 2 x 4 mm ² + (2 x 0.75 mm ²) P + 10 x 0.75 mm ²	2 x 35 mm ² + 1 x 25 mm ² + 2 x 4 mm ² + (2 x 0.75 mm ²) P + 10 x 0.75 mm ²	2 x 50 mm ² + 1 x 25 mm ² + 2 x 4 mm ² + (2 x 0.75 mm ²) P + 10 x 0.75 mm ²	2 x 70 mm ² + 1 x 25 mm ² + 2 x 4 mm ² + (2 x 0.75 mm ²) P + 10 x 0.75 mm ²
Sheath color	black	black	black	black
Ordering data				
Description	Order No.	Pcs./Pkt.	Order No.	Pcs./Pkt.
	80 A		125 A	
GB/T DC charging cable	1031383	1	1031381	1
Accessories				
Description	Type	Order No.	Pcs./Pkt.	
	Without vehicle charging connector recognition	EV-GBDC-PARK	1623770	1
With vehicle charging connector recognition	EV-GBDC-PARK-SW	1623497	1	
Fixing with hexagonal head screws	EV-GBDC-PARK-R	1623496	1	

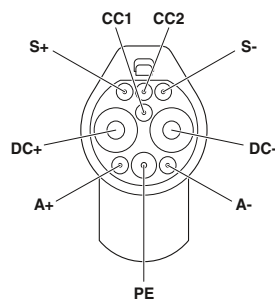



Extremely short charging times

With the High Power Charging (HPC) system, Phoenix Contact has developed a charging technology that can charge the battery of an electric vehicle for a distance of 100 km in just three to five minutes. The centerpiece of this technology is a high-performance charging connector with intelligent cooling that allows for a charging current of up to 500 A. At a system voltage of 1000 V, this corresponds to a charging power of 500,000 W.

Until now, charging currents of up to 200 A were technically feasible with the Combined Charging System (CCS). Significantly higher currents are necessary, however, to achieve very short charging times. With conventional charging technology, this would result in dangerous overheating or would require larger, cumbersome cable diameters.

Our intelligent HPC technology is therefore based on a coolant system that enables charging currents of up to 500 A without compromising safety or manageability. We use an environmentally-sound, maintenance-friendly water-glycol mixture as the coolant. This cools both the charging cable and the DC power contacts in the charging connector. The contact carrier in the charging connector also acts as a heatsink, thanks to its outstanding thermal conductivity.

How does the cooling system work?

In accordance with the VDE-AR-E 2623-5-3 directive and the IEC TS 62196-3-1 standard, charging connectors and charging cables may not exceed a temperature that is 50 K higher than the ambient air temperature during the charging process ($\Delta T_{\max} = 50 \text{ K}$).

In order to comply with these regulations, multiple temperature sensors integrated into the Phoenix Contact HPC system measure the heat produced directly at the charging connector power contacts and also in the charging cable in real time.

A controller evaluates the data collected and regulates the cooling output accordingly. This reliably prevents overheating in compliance with standards and, at the same time, increases the energy efficiency of the cooling system.

Easy maintenance of the cooling circuit

Thanks to the use of an environmentally friendly mixture of water and glycol as the coolant, the cooling circuit is relatively easy to maintain. In contrast to maintenance-intensive closed systems with oil cooling, the semi-open system necessary for our charging connectors is easy to maintain, e.g. when refilling the coolant.

Your advantages

- Fast charging in just a few minutes, thanks to extremely high charging powers of up to 500 kW
- Efficient cooling enables cables of smaller diameters to be used, which improves handling
- Extremely safe, thanks to continuous temperature and leak monitoring along with a wear indicator in the cable sheathing
- Maintenance-friendly, thanks to the easily replaceable mating face and semi-open cooling system with environmentally friendly coolant
- Fully compatible with the established Combined Charging System (CCS)

i Your web code: #1631



CCS type 1 and CCS type 2

The cooled HPC system DC charging cables from Phoenix Contact are fully compatible and compliant with the established Combined Charging System for North America (CCS type 1) and Europe (CCS type 2). Furthermore, we can provide you with suitable control technology for the charging process and cooling, as well as a broad range of further products for your HPC fast charging stations.



Optional panel feed-through

The optional panel feed-through makes installing the HPC charging cable on the charging station quick, safe, and easy. It is equipped with defined interfaces for power, communication, and cooling. The panel feed-through is supplied pre-mounted on the charging cable. We offer all HPC charging cables with straight or angled panel feed-through, or without panel feed-through.



Replaceable mating face

Charging cables at public charging stations, and mating faces in particular, are subject to high levels of mechanical strain. Therefore, the mating face frames and power contacts of our HPC charging connectors can be replaced quickly, minimizing downtime and ensuring that the costly replacement of the entire HPC charging cable is not necessary. The repair kits are listed in the “Accessories” section.

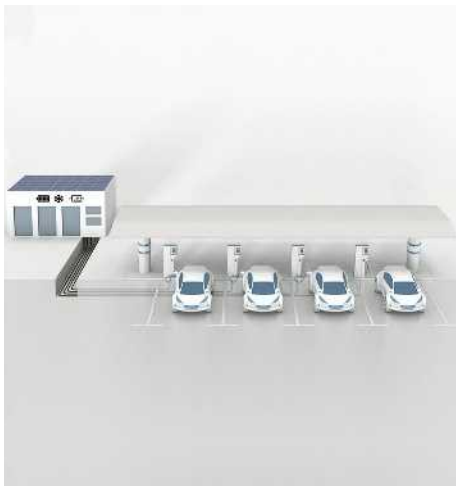

Use in charging facilities and charging parks

In these applications, the cooling system and controller are mainly housed centrally – in a separate building, for example. The decentral charging stations are supplied with coolant from there, and are only fitted with individual heat exchangers. Therefore all charging stations use a common cooling circuit.



Use in stand-alone charging stations

A complete HPC system can also be installed in a single charging column. This means that the cooling unit and controller are integrated into the charging column to create an independent cooling circuit together with the charging connector and charging cable.



Configuring your cooled HPC solution

Based on the installation space available for your charging columns, the climatic conditions at the installation location, and additional factors, we will configure the ideal combination of HPC charging cables, panel feed-throughs, controllers, and other components. We are also happy to recommend appropriate cooling units and heat exchangers from one of our technology partners.

Charging connection systems

Cooled DC charging cables – High Power Charging

CCS type 2

- Ultra-fast charging
- Charging cables for European charging infrastructure
- Cooled vehicle charging connector
- Cooled charging cables

Notes:
Upon request, we can also supply charging connectors with your company logo, as well as further cable types and lengths.

High Power Charging Technology[®]
<https://www.phoenixcontact.com>



With a metric cable and angled panel feed-through, left-hand side

High Power Charging Technology[®]
<https://www.phoenixcontact.com>



With a metric cable and angled panel feed-through, right-hand side

Technical data	
Rated voltage	1000 V DC
Rated current	500 A
Standards	IEC 62196-3-1
Charging mode	Mode 4
Resistor coding	1500 Ω (between PE and PP)
Ambient temperature (operation)	-30°C ... 40°C
Number of power contacts	3 (PE, DC+, DC-)
Insertion/withdrawal cycles	> 10,000
Insertion/withdrawal force	< 100 N
Temperature monitoring	2x NTC (replaceable, front DC contacts) 2x NTC (DC power wires inside)
Degree of protection (when plugged in)	IP54
Cable data	
Cable type	straight
Cable length	5 m
Cable diameter	35.7 mm ±0.4 mm
Cable structure	5 x 25 mm ² + 7 x 0.75 mm ²
Sheath color	black
Panel feed-through	
Type	Left-hand angled panel feed-through
Panel thickness	max. 5 mm
Required mounting screws	M5x16
Dimensions (H x W x D)	80 mm x 82 mm x 215.5 mm
Fan for panel feed-through	
Ambient temperature (operation)	-20°C ... 40°C
Mechanical service life	70.000 h (at 40°C)
Connection type	2 x AWG 26
Nominal voltage U _N	24 V DC
Nominal voltage range	18 V DC ... 24 V DC
Fan volumetric flow	28 m ³ /h
Fan speed indication	4400 min-1
Requirements on a cooling unit	
Cooling capacity	600 W
Flow rate	2 l/min
Operating pressure	1.00 bar ... 2.00 bar
Flow temperature	10°C

Technical data	
Rated voltage	1000 V DC
Rated current	400 A
Standards	IEC 62196-3-1
Charging mode	Mode 4
Resistor coding	1500 Ω (between PE and PP)
Ambient temperature (operation)	-30°C ... 40°C
Number of power contacts	3 (PE, DC+, DC-)
Insertion/withdrawal cycles	> 10,000
Insertion/withdrawal force	< 100 N
Temperature monitoring	2x NTC (replaceable, front DC contacts) 2x NTC (DC power wires inside)
Degree of protection (when plugged in)	IP54
Cable data	
Cable type	straight
Cable length	5 m
Cable diameter	35.7 mm ±0.4 mm
Cable structure	5 x 25 mm ² + 7 x 0.75 mm ²
Sheath color	black
Panel feed-through	
Type	Left-hand angled panel feed-through
Panel thickness	max. 5 mm
Required mounting screws	M5x16
Dimensions (H x W x D)	80 mm x 82 mm x 215.5 mm
Fan for panel feed-through	
Ambient temperature (operation)	-20°C ... 40°C
Mechanical service life	70.000 h (at 40°C)
Connection type	2 x AWG 26
Nominal voltage U _N	24 V DC
Nominal voltage range	18 V DC ... 24 V DC
Fan volumetric flow	28 m ³ /h
Fan speed indication	4400 min-1
Requirements on a cooling unit	
Cooling capacity	600 W
Flow rate	2 l/min
Operating pressure	1.00 bar ... 2.00 bar
Flow temperature	20°C

Technical data	
Rated voltage	1000 V DC
Rated current	400 A
Standards	IEC 62196-3-1
Charging mode	Mode 4
Resistor coding	1500 Ω (between PE and PP)
Ambient temperature (operation)	-30°C ... 40°C
Number of power contacts	3 (PE, DC+, DC-)
Insertion/withdrawal cycles	> 10,000
Insertion/withdrawal force	< 100 N
Temperature monitoring	2x NTC (replaceable, front DC contacts) 2x NTC (DC power wires inside)
Degree of protection (when plugged in)	IP54
Cable data	
Cable type	straight
Cable length	5 m
Cable diameter	35.7 mm ±0.4 mm
Cable structure	5 x 25 mm ² + 7 x 0.75 mm ²
Sheath color	black
Panel feed-through	
Type	Right-hand angled panel feed-through
Panel thickness	max. 5 mm
Required mounting screws	M5x16
Dimensions (H x W x D)	80 mm x 82 mm x 215.5 mm
Fan for panel feed-through	
Ambient temperature (operation)	-20°C ... 40°C
Mechanical service life	70.000 h (at 40°C)
Connection type	2 x AWG 26
Nominal voltage U _N	24 V DC
Nominal voltage range	18 V DC ... 24 V DC
Fan volumetric flow	28 m ³ /h
Fan speed indication	4400 min-1
Requirements on a cooling unit	
Cooling capacity	600 W
Flow rate	2 l/min
Operating pressure	1.00 bar ... 2.00 bar
Flow temperature	20°C

Description	Ordering data			
	Order No.	Pcs./Pkt.	Order No.	Pcs./Pkt.
CCS type 2 DC charging cable, cooled	500 A		400 A	
	1085637	1	1052443	1

Description	Ordering data			
	Order No.	Pcs./Pkt.	Order No.	Pcs./Pkt.
CCS type 2 DC charging cable, cooled	500 A		400 A	
	1089665	1	1089664	1

Description	Accessories		
	Type	Order No.	Pcs./Pkt.
Holder Without vehicle charging connector recognition	EVT2CCS-PARK	1624153	1
Repair kit	EVT2CCS-MF-M4X10-BIT-CTS	1085799	1
	EVT2CCS-MF-M4X10-BIT	1085798	1
	EVT2CCS-MF-M4X10	1085797	1

Description	Accessories		
	Type	Order No.	Pcs./Pkt.
Holder Without vehicle charging connector recognition	EVT2CCS-PARK	1624153	1
Repair kit	EVT2CCS-MF-M4X10-BIT-CTS	1085799	1
	EVT2CCS-MF-M4X10-BIT	1085798	1
	EVT2CCS-MF-M4X10	1085797	1

High Power Charging Technology[®]
Copyright © 2018 PHOENIX CONTACT



With a metric cable and straight panel feed-through

High Power Charging Technology[®]
Copyright © 2018 PHOENIX CONTACT



With metric cable, without panel feed-through

Technical data		Technical data	
500 A	400 A	500 A	
1000 V DC	1000 V DC	1000 V DC	
500 A	400 A	500 A	
IEC 62196-3-1	IEC 62196-3-1	IEC 62196-3-1	
Mode 4	Mode 4	Mode 4	
1500 Ω (between PE and PP)	1500 Ω (between PE and PP)	1500 Ω (between PE and PP)	
-30°C ... 40°C	-30°C ... 40°C	-30°C ... 40°C	
3 (PE, DC+, DC-)	3 (PE, DC+, DC-)	3 (PE, DC+, DC-)	
> 10,000	> 10,000	> 10,000	
< 100 N	< 100 N	< 100 N	
2x NTC (replaceable, front DC contacts)	2x NTC (replaceable, front DC contacts)	2x NTC (replaceable, front DC contacts)	
2x NTC (DC power wires inside)	2x NTC (DC power wires inside)	2x NTC (DC power wires inside)	
IP54	IP54	IP54	
straight	straight	straight	
5 m	5 m	5 m	
35.7 mm ±0.4 mm	35.7 mm ±0.4 mm	35.7 mm ±0.4 mm	
5 x 25 mm ² + 7 x 0.75 mm ²	5 x 25 mm ² + 7 x 0.75 mm ²	5 x 25 mm ² + 7 x 0.75 mm ²	
black	black	black	
Straight panel feed-through	Straight panel feed-through	-	
max. 5 mm	max. 5 mm	-	
M5x16	M5x16	-	
80 mm x 82 mm x 227.69 mm	80 mm x 82 mm x 227.69 mm	-	
-20°C ... 40°C	-	-	
70.000 h (at 40°C)	-	-	
2 x AWG 26	-	-	
24 V DC	-	-	
18 V DC ... 24 V DC	-	-	
28 m ³ /h	-	-	
4400 min-1	-	-	
600 W	600 W	600 W	
2 l/min	2 l/min	2 l/min	
1.00 bar ... 2.00 bar	1.00 bar ... 2.00 bar	1.00 bar ... 2.00 bar	
10°C	20°C	10°C	

Ordering data				Ordering data			
Order No.	Pcs./Pkt.	Order No.	Pcs./Pkt.	Order No.	Pcs./Pkt.	Order No.	Pcs./Pkt.
500 A		400 A		500 A			
1085631	1	1052444	1	1085638	1		

Accessories			Accessories		
Type	Order No.	Pcs./Pkt.	Type	Order No.	Pcs./Pkt.
EV-T2CCS-PARK	1624153	1	EV-T2CCS-PARK	1624153	1
EV-T2CCS-MF-M4X10-BIT-CTS	1085799	1	EV-T2CCS-MF-M4X10-BIT-CTS	1085799	1
EV-T2CCS-MF-M4X10-BIT	1085798	1	EV-T2CCS-MF-M4X10-BIT	1085798	1
EV-T2CCS-MF-M4X10	1085797	1	EV-T2CCS-MF-M4X10	1085797	1



A wide range of products for every application

Conventional charging with alternating current (AC) in private and commercial applications in accordance with charging mode 3 is also playing an important role in establishing electromobility.

For this charging mode, we provide a complete range of VDE-, UL-, and PSE-certified AC charging cables for charging powers of up to 26 kW – standard-compliant and for all country-specific standards. This means we can offer you the right charging cable for every application:

- You need a charging cable with a free cable end for charging case C. In this case, the charging cable is permanently connected to the charging station.
- Mobile charging cables are used in charging case B and are, for example, carried in the trunk of the vehicle. The cable is equipped with a connecting element at both ends.
- Mobile adapter charging cables are the ideal solution for charging case B if, for example, a vehicle with an American type 1 inlet needs to be charged at a European type 2 charging station.

Winner of the German Design Award

Our type 2 AC charging cables have received the German Design Award 2019 in the “Special Mention” category.

During development of the product family, we focused on ensuring that the design was both ergonomic and stylish, as well as using robust and top-quality materials in order to satisfy the stringent requirements of the automotive industry.

The German Design Award jury was impressed with the nominated charging cable: “Thanks to the ergonomic design, the cable is pleasant to hold, which makes it easier to use. A functionally sophisticated design that is also aesthetically impressive, thanks to its modern shape and two-tone look.” This was the feedback from the jury, which was comprised of design experts from the fields of business, academia, and science, as well as the design industry.

Your advantages

- Comprehensive product range for type 1, type 2, and GB/T
- Ergonomic design means that the cables are easy to use – winner of the German Design Award 2019
- Upon request, we can also include your company logo to ensure consistent branding of your charging station or wall box
- Efficient power transmission and long-term stability, thanks to silver-plated power and signal contacts
- Longitudinal water tightness reliably prevents water from permeating the cable
- Developed and produced in accordance with the IATF 16949 automotive standard and ISO 9001
- Tested in accordance with selected tests of automotive standards LV124, LV214, and LV215-2

i Your web code: #1022



Type 1

Type 1 AC charging cables in accordance with SAE J1772 and IEC 62196-2 are primarily used in the USA and Japan. The cables are locked by means of a lever locking mechanism that interrupts the power when actuated. Versions are available with metric, AWG, and PSE cables for charging currents of up to 32 A and voltages of up to 250 V.



Type 2

Type 2 AC charging cables in accordance with IEC 62196-2 support single- and three-phase charging in Europe. An electro-mechanical actuator locking mechanism safeguards the charging process. Versions are available with metric cables for charging currents of up to 32 A and voltages of up to 480 V.



GB/T

The standard GB/T 20234.2 describes single- and three-phase charging in China. A special lever system ensures that the vehicle inlet and vehicle charging connector latch together securely. Versions are available with metric cables for charging currents of up to 32 A and voltages of up to 480 V.



Additional locking option

Our type 1 and GB/T AC charging cables can also be locked with a padlock (shackle diameter: 4 mm) as an option. The locking lever can no longer be actuated when plugged in.



Charging connectors with your logo

We can also integrate your company logo into our AC charging connectors upon request. This will make your charging station or wall box an integral part of your uniform branding concept and outward appearance. We can either emboss your logo into the soft components of the charging connector or, if you would like, we can print UV- and weather-resistant adhesive labels either in black and white or in color.



Tailored charging cables

Our broad product range allows you to choose from a variety of lengths and cross sections, metric or AWG cables, and spiraled or straight cables. If you are unable to find your preferred combination within our range, we can also design and manufacture customer-specific items. We can also supply the cable end preassembled, compacted, or with a step cut upon request.

Charging connection systems

AC charging cables

Type 2 with one free cable end

- Charging cables for European charging infrastructure
- Vehicle-side locking with electro-mechanical locking actuator
- Vehicle charging connector with a protective cap

Notes:
Upon request, we can also supply charging connectors with your company logo, further cable types and lengths, as well as cable ends that are preassembled or compacted, or with a step cut.



**1-phase, black,
with a spiraled metric cable**



**1-phase, black,
with a straight metric cable**



Technical data		
	20 A	32 A
Number of phases	1	1
Rated voltage	250 V AC	250 V AC
Rated current	20 A	32 A
Standards	IEC 62196-2	IEC 62196-2
Charging mode	Mode 3, Case C	Mode 3, Case C
Resistor coding	680 Ω (between PE and PP)	220 Ω (between PE and PP)
Ambient temperature (operation)	-30°C ... 50°C	-30°C ... 50°C
Number of power contacts	3 (L1, N, PE)	3 (L1, N, PE)
Insertion/withdrawal cycles	> 10,000	> 10,000
Insertion/withdrawal force	< 100 N	< 100 N
Degree of protection (when plugged in)	IP44	IP44
Degree of protection (with protective cap)	IP54	IP54
Cable data		
Cable type	spiraled	spiraled
Cable length	4 m	4 m
Cable diameter	10.2 mm ±0,3 mm	12.8 mm ±0,4 mm
Cable structure	3 x 2.5 mm ² + 1 x 0.5 mm ²	3 x 6.0 mm ² + 1 x 0.5 mm ²
Sheath color	black	black



Technical data		
	20 A	32 A
Number of phases	1	1
Rated voltage	250 V AC	250 V AC
Rated current	20 A	32 A
Standards	IEC 62196-2	IEC 62196-2
Charging mode	Mode 3, Case C	Mode 3, Case C
Resistor coding	680 Ω (between PE and PP)	220 Ω (between PE and PP)
Ambient temperature (operation)	-30°C ... 50°C	-30°C ... 50°C
Number of power contacts	3 (L1, N, PE)	3 (L1, N, PE)
Insertion/withdrawal cycles	> 10,000	> 10,000
Insertion/withdrawal force	< 100 N	< 100 N
Degree of protection (when plugged in)	IP44	IP44
Degree of protection (with protective cap)	IP54	IP54
Cable data		
Cable type	straight	straight
Cable length	5 m	5 m
Cable diameter	10.2 mm ±0,3 mm	12.8 mm ±0,4 mm
Cable structure	3 x 2.5 mm ² + 1 x 0.5 mm ²	3 x 6.0 mm ² + 1 x 0.5 mm ²
Sheath color	black	black

Ordering data	
Order No.	Pcs./Pkt.
	20 A
	32 A

AC charging cable with a type 2 AC vehicle charging connector and a free cable end

Ordering data			
Order No.	Pcs./Pkt.	Order No.	Pcs./Pkt.
	20 A		32 A
1056548	1	1056575	1

Ordering data			
Order No.	Pcs./Pkt.	Order No.	Pcs./Pkt.
	20 A		32 A
1056696	1	1097298	1

Accessories		
Type	Order No.	Pcs./Pkt.
Holder		
Without vehicle charging connector recognition	1624148	1

Accessories		
Type	Order No.	Pcs./Pkt.
Holder		
Without vehicle charging connector recognition	1624148	1

Accessories		
Type	Order No.	Pcs./Pkt.
Holder		
Without vehicle charging connector recognition	1624148	1

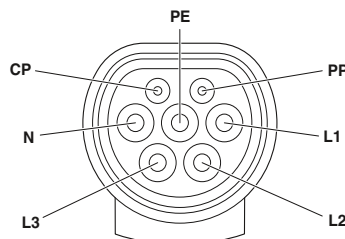

Vehicle charging connector pin assignment



3-phase, black,
with a spiraled metric cable



3-phase, black,
with a straight metric cable



Technical data	
20 A	32 A
3	3
480 V AC	480 V AC
20 A	32 A
IEC 62196-2	IEC 62196-2
Mode 3, Case C	Mode 3, Case C
680 Ω (between PE and PP)	220 Ω (between PE and PP)
-30°C ... 50°C	-30°C ... 50°C
5 (L1, L2, L3, N, PE)	5 (L1, L2, L3, N, PE)
> 10,000	> 10,000
< 100 N	< 100 N
IP44	IP44
IP54	IP54
spiraled	spiraled
4 m	4 m
12.8 mm ±0.4 mm	17 mm ±0.4 mm
5 x 2.5 mm ² + 1 x 0.5 mm ²	5 x 6.0 mm ² + 1 x 0.5 mm ²
black	black

Technical data	
20 A	32 A
3	3
480 V AC	480 V AC
20 A	32 A
IEC 62196-2	IEC 62196-2
Mode 3, Case C	Mode 3, Case C
680 Ω (between PE and PP)	220 Ω (between PE and PP)
-30°C ... 50°C	-30°C ... 50°C
5 (L1, L2, L3, N, PE)	5 (L1, L2, L3, N, PE)
> 10,000	> 10,000
< 100 N	< 100 N
IP44	IP44
IP54	IP54
straight	straight
5 m	5 m
12.8 mm ±0.4 mm	17 mm ±0.4 mm
5 x 2.5 mm ² + 1 x 0.5 mm ²	5 x 6.0 mm ² + 1 x 0.5 mm ²
black	black

Ordering data			
Order No.	Pcs./Pkt.	Order No.	Pcs./Pkt.
20 A		32 A	
1097295	1	1056698	1

Ordering data			
Order No.	Pcs./Pkt.	Order No.	Pcs./Pkt.
20 A		32 A	
1056697	1	1056700	1

Accessories		
Type	Order No.	Pcs./Pkt.
EV-T2AC-PARK	1624148	1

Accessories		
Type	Order No.	Pcs./Pkt.
EV-T2AC-PARK	1624148	1

Charging connection systems

AC charging cables

Type 2 with one free cable end

- Charging cables for European charging infrastructure
- Vehicle-side locking with electro-mechanical locking actuator
- Vehicle charging connector with a protective cap

Notes:
Upon request, we can also supply charging connectors with your company logo, further cable types and lengths, as well as cable ends that are preassembled or compacted, or with a step cut.



1-phase, gray-black, with a spiraled metric cable



1-phase, gray-black, with a straight metric cable



	Technical data	
	20 A	32 A
Number of phases	1	1
Rated voltage	250 V AC	250 V AC
Rated current	20 A	32 A
Standards	IEC 62196-2	IEC 62196-2
Charging mode	Mode 3, Case C	Mode 3, Case C
Resistor coding	680 Ω (between PE and PP)	220 Ω (between PE and PP)
Ambient temperature (operation)	-30°C ... 50°C	-30°C ... 50°C
Number of power contacts	3 (L1, N, PE)	3 (L1, N, PE)
Insertion/withdrawal cycles	> 10,000	> 10,000
Insertion/withdrawal force	< 100 N	< 100 N
Degree of protection (when plugged in)	IP44	IP44
Degree of protection (with protective cap)	IP54	IP54
Cable data		
Cable type	spiraled	spiraled
Cable length	4 m	4 m
Cable diameter	10.2 mm ±0,3 mm	12.8 mm ±0,4 mm
Cable structure	3 x 2.5 mm ² + 1 x 0.5 mm ²	3 x 6.0 mm ² + 1 x 0.5 mm ²
Sheath color	black	black



	Technical data	
	20 A	32 A
Number of phases	1	1
Rated voltage	250 V AC	250 V AC
Rated current	20 A	32 A
Standards	IEC 62196-2	IEC 62196-2
Charging mode	Mode 3, Case C	Mode 3, Case C
Resistor coding	680 Ω (between PE and PP)	220 Ω (between PE and PP)
Ambient temperature (operation)	-30°C ... 50°C	-30°C ... 50°C
Number of power contacts	3 (L1, N, PE)	3 (L1, N, PE)
Insertion/withdrawal cycles	> 10,000	> 10,000
Insertion/withdrawal force	< 100 N	< 100 N
Degree of protection (when plugged in)	IP44	IP44
Degree of protection (with protective cap)	IP54	IP54
Cable data		
Cable type	straight	straight
Cable length	5 m	5 m
Cable diameter	10.2 mm ±0,3 mm	12.8 mm ±0,4 mm
Cable structure	3 x 2.5 mm ² + 1 x 0.5 mm ²	3 x 6.0 mm ² + 1 x 0.5 mm ²
Sheath color	black	black

Description
AC charging cable with a type 2 AC vehicle charging connector and a free cable end without locking

Ordering data			
Order No.	Pcs./Pkt.	Order No.	Pcs./Pkt.
20 A		32 A	
1627126	1	1627127	1

Ordering data			
Order No.	Pcs./Pkt.	Order No.	Pcs./Pkt.
20 A		32 A	
1627354	1	1627366	1

Description
Holder Without vehicle charging connector recognition

Accessories			
Type	Order No.	Pcs./Pkt.	
EV-T2AC-PARK	1624148	1	

Accessories			
Type	Order No.	Pcs./Pkt.	
EV-T2AC-PARK	1624148	1	

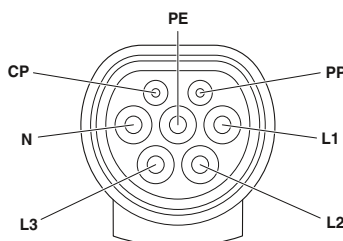

Vehicle charging connector pin assignment



3-phase, gray-black,
with a spiraled metric cable



3-phase, gray-black,
with a straight metric cable



Technical data	
20 A	32 A
3	3
480 V AC	480 V AC
20 A	32 A
IEC 62196-2	IEC 62196-2
Mode 3, Case C	Mode 3, Case C
680 Ω (between PE and PP)	220 Ω (between PE and PP)
-30°C ... 50°C	-30°C ... 50°C
5 (L1, L2, L3, N, PE)	5 (L1, L2, L3, N, PE)
> 10,000	> 10,000
< 100 N	< 100 N
IP44	IP44
IP54	IP54
spiraled	spiraled
4 m	4 m
12.8 mm ±0.4 mm	17 mm ±0.4 mm
5 x 2.5 mm ² + 1 x 0.5 mm ²	5 x 6.0 mm ² + 1 x 0.5 mm ²
black	black

Technical data	
20 A	32 A
3	3
480 V AC	480 V AC
20 A	32 A
IEC 62196-2	IEC 62196-2
Mode 3, Case C	Mode 3, Case C
680 Ω (between PE and PP)	220 Ω (between PE and PP)
-30°C ... 50°C	-30°C ... 50°C
5 (L1, L2, L3, N, PE)	5 (L1, L2, L3, N, PE)
> 10,000	> 10,000
< 100 N	< 100 N
IP44	IP44
IP54	IP54
straight	straight
5 m	5 m
12.8 mm ±0.4 mm	17 mm ±0.4 mm
5 x 2.5 mm ² + 1 x 0.5 mm ²	5 x 6.0 mm ² + 1 x 0.5 mm ²
black	black

Ordering data			
Order No.	Pcs./Pkt.	Order No.	Pcs./Pkt.
20 A		32 A	

Ordering data			
Order No.	Pcs./Pkt.	Order No.	Pcs./Pkt.
20 A		32 A	

1627128	1	1627130	1
---------	---	---------	---

1627365	1	1627355	1
---------	---	---------	---

Accessories		
Type	Order No.	Pcs./Pkt.
EV-T2AC-PARK	1624148	1

Accessories		
Type	Order No.	Pcs./Pkt.
EV-T2AC-PARK	1624148	1

Charging connection systems

AC charging cables

Type 1 with one free cable end

- Charging cables for North American, Japanese, and European charging infrastructure
- Locking on the vehicle side with lever mechanism
- Additional locking option with padlock
- Vehicle charging connector with a protective cap

Notes:
Upon request, we can also supply charging connectors with your company logo, further cable types and lengths, as well as cable ends that are preassembled or compacted, or with a step cut.



Gray-black, with a spiraled metric cable



Gray-black, with a straight metric cable



	Technical data		Technical data	
	20 A	32 A	20 A	32 A
Number of phases	1	1	1	1
Rated voltage	250 V AC	250 V AC	250 V AC	250 V AC
Rated current	20 A	32 A	20 A	32 A
Standards	IEC 62196-2	IEC 62196-2	IEC 62196-2	IEC 62196-2
Charging mode	Mode 3, Case C	Mode 3, Case C	Mode 3, Case C	Mode 3, Case C
Resistor coding	480 Ω (Lever actuated) 150 Ω (Lever not actuated)	480 Ω (Lever actuated) 150 Ω (Lever not actuated)	480 Ω (Lever actuated) 150 Ω (Lever not actuated)	480 Ω (Lever actuated) 150 Ω (Lever not actuated)
Ambient temperature (operation)	-30°C ... 50°C	-30°C ... 50°C	-30°C ... 50°C	-30°C ... 50°C
Number of power contacts	3 (L1, N, PE)	3 (L1, N, PE)	3 (L1, N, PE)	3 (L1, N, PE)
Insertion/withdrawal cycles	> 10,000	> 10,000	> 10,000	> 10,000
Insertion/withdrawal force	< 75 N	< 75 N	< 75 N	< 75 N
Degree of protection (when plugged in)	IP44	IP44	IP44	IP44
Degree of protection (with protective cap)	IP54	IP54	IP54	IP54
Cable data				
Cable type	spiraled	spiraled	straight	straight
Cable length	4 m	4 m	5 m	5 m
Cable diameter	10.2 mm ±0.3 mm	12.8 mm ±0.4 mm	10.2 mm ±0.3 mm	12.8 mm ±0.4 mm
Cable structure	3 x 2.5 mm ² + 1 x 0.5 mm ²	3 x 6.0 mm ² + 1 x 0.5 mm ²	3 x 2.5 mm ² + 1 x 0.5 mm ²	3 x 6.0 mm ² + 1 x 0.5 mm ²
Sheath color	black	black	black	black

Description	Ordering data				Ordering data			
	Order No.	Pcs./Pkt.	Order No.	Pcs./Pkt.	Order No.	Pcs./Pkt.	Order No.	Pcs./Pkt.
AC charging cable with a type 1 AC vehicle charging connector and a free cable end								
without additional locking option with padlock	1627345	1	1627344	1	1628013	1	1628096	1
with additional locking option with padlock	1623238	1	1623239	1	1627362	1	1627356	1

Description	Accessories			Accessories		
	Type	Order No.	Pcs./Pkt.	Type	Order No.	Pcs./Pkt.
Holder						
Without vehicle charging connector recognition	EV-T1AC-PARK	1624139	1	EV-T1AC-PARK	1624139	1

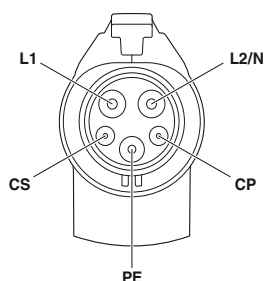

Vehicle charging connector pin assignment

Charging connection systems

AC charging cables

Type 1 with one free cable end

- Charging cables for North American, Japanese, and European charging infrastructure
- Locking on the vehicle side with lever mechanism
- Additional locking option with padlock
- Vehicle charging connector with a protective cap

Notes:
Upon request, we can also supply charging connectors with your company logo, further cable types and lengths, as well as cable ends that are preassembled or compacted, or with a step cut.



Gray-black,
with a straight AWG cable



Black,
with a straight AWG cable

Number of phases	1
Rated voltage	250 V AC
Rated current	15 A
Standards	SAE J1772
Charging mode	Level 2
Resistor coding	480 Ω (Lever actuated) 150 Ω (Lever not actuated)
Ambient temperature (operation)	-30°C ... 50°C
Number of power contacts	3 (L1, N, PE)
Insertion/withdrawal cycles	> 10,000
Insertion/withdrawal force	< 75 N
Degree of protection (NEMA)	3R
Cable data	
Cable type	straight
Cable length	5 m
Cable diameter	10.5 mm ±0.3 mm
Cable structure	3 x 14 AWG + 1 x 20 AWG
Sheath color	black

Technical data	
15 A	32 A
Number of phases	1
Rated voltage	250 V AC
Rated current	32 A
Standards	SAE J1772
Charging mode	Level 2
Resistor coding	480 Ω (Lever actuated) 150 Ω (Lever not actuated)
Ambient temperature (operation)	-30°C ... 50°C
Number of power contacts	3 (L1, N, PE)
Insertion/withdrawal cycles	> 10,000
Insertion/withdrawal force	< 75 N
Degree of protection (NEMA)	3R
Cable data	
Cable type	straight
Cable length	5 m
Cable diameter	17 mm ±0.4 mm
Cable structure	3 x 10 AWG + 1 x 18 AWG
Sheath color	black

Technical data	
15 A	32 A
Number of phases	1
Rated voltage	250 V AC
Rated current	32 A
Standards	SAE J1772
Charging mode	Level 2
Resistor coding	480 Ω (Lever actuated) 150 Ω (Lever not actuated)
Ambient temperature (operation)	-30°C ... 50°C
Number of power contacts	3 (L1, N, PE)
Insertion/withdrawal cycles	> 10,000
Insertion/withdrawal force	< 75 N
Degree of protection (NEMA)	3R
Cable data	
Cable type	straight
Cable length	5 m
Cable diameter	10.5 mm ±0.3 mm
Cable structure	3 x 14 AWG + 1 x 20 AWG
Sheath color	black

Ordering data	
Order No.	Pcs./Pkt.
	15 A
	32 A
AC charging cable with a type 1 AC vehicle charging connector and a free cable end	
	without additional locking option with padlock
	with additional locking option with padlock

Ordering data	
Order No.	Pcs./Pkt.
	15 A
	32 A
	without additional locking option with padlock
	with additional locking option with padlock

Ordering data	
Order No.	Pcs./Pkt.
	15 A
	32 A
	without additional locking option with padlock
	with additional locking option with padlock

Accessories	
Type	Order No.
Holder	
Without vehicle charging connector recognition	

Accessories	
Type	Order No.
Holder	
Without vehicle charging connector recognition	

Accessories	
Type	Order No.
Holder	
Without vehicle charging connector recognition	

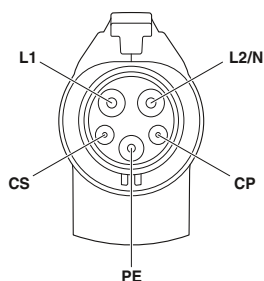

Vehicle charging connector pin assignment

GB/T with one free cable end

- Charging cables for the Chinese charging infrastructure
- Locking on the vehicle side with lever mechanism
- Additional locking option with padlock
- Vehicle charging connector with a protective cap

Notes:
Upon request, we can also supply charging connectors with your company logo, further cable types and lengths, as well as cable ends that are preassembled or compacted, or with a step cut.



1-phase, gray-black, with a straight metric cable



3-phase, gray-black, with a straight metric cable

	Technical data		Technical data	
	16 A	32 A	16 A	32 A
Number of phases	1	1	3	3
Rated voltage	250 V	250 V	440 V	440 V
Rated current	16 A	32 A	16 A	32 A
Standards	GB/T 20234.2-2015	GB/T 20234.2-2015	GB/T 20234.2-2015	GB/T 20234.2-2015
Charging mode	Mode 3, Case C	Mode 3, Case C	Mode 3, Case C	Mode 3, Case C
Resistor coding	680 Ω + 2.7 kΩ (Lever actuated) 680 Ω (Lever not actuated)	220 Ω + 3..3 kΩ (Lever actuated) 220 Ω (Lever not actuated)	680 Ω + 2.7 kΩ (Lever actuated) 680 Ω (Lever not actuated)	220 Ω + 3..3 kΩ (Lever actuated) 220 Ω (Lever not actuated)
Ambient temperature (operation)	-30°C ... 50°C	-30°C ... 50°C	-30°C ... 50°C	-30°C ... 50°C
Number of power contacts	3 (L, N, PE)	3 (L, N, PE)	5 (L1, L2, L3, N, PE)	5 (L1, L2, L3, N, PE)
Insertion/withdrawal cycles	> 10,000	> 10,000	> 10,000	> 10,000
Insertion/withdrawal force	< 100 N	< 100 N	< 100 N	< 100 N
Degree of protection (when plugged in)	IP55	IP55	IP55	IP55
Degree of protection (with protective cap)	IP54	IP54	IP54	IP54
Cable data				
Cable type	straight	straight	straight	straight
Cable length	5 m	5 m	5 m	5 m
Cable diameter	10.2 mm ±0.3 mm	12.8 mm ±0.4 mm	12.8 mm ±0.4 mm	17 mm ±0.4 mm
Cable structure	3 x 2.5 mm ² + 1 x 0.5 mm ²	3 x 6.0 mm ² + 1 x 0.5 mm ²	5 x 2.5 mm ² + 1 x 0.5 mm ²	5 x 6.0 mm ² + 1 x 0.5 mm ²
Sheath color	black	black	black	black

Description	Ordering data			
	Order No.	Pcs./Pkt.	Order No.	Pcs./Pkt.
AC charging cable with a GB/T AC vehicle charging connector and a free cable end				
without additional locking option with padlock	1627599	1	1627601	1
with additional locking option with padlock	1623510	1	1623511	1

Description	Ordering data			
	Order No.	Pcs./Pkt.	Order No.	Pcs./Pkt.
AC charging cable with a GB/T AC vehicle charging connector and a free cable end				
without additional locking option with padlock	1627600	1	1627602	1
with additional locking option with padlock	1623512	1	1624137	1

Description	Accessories			Accessories		
	Type	Order No.	Pcs./Pkt.	Type	Order No.	Pcs./Pkt.
Holder						
Without vehicle charging connector recognition	EV-GBAC-PARK	1624142	1	EV-GBAC-PARK	1624142	1

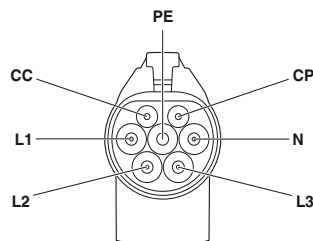

GB/T vehicle charging connector pin assignment

Charging connection systems

AC charging cables

Mobile type 2 design

- Mobile charging cables for European charging infrastructure
- Vehicle- and infrastructure-side locking mechanism with electromechanical locking actuator
- Vehicle charging connector and infrastructure charging plug with protective cap

Notes:

Upon request, we can also supply charging connectors with your company logo, as well as further cable types and lengths.



1-phase, gray-black,
with a spiraled metric cable



1-phase, gray-black,
with a straight metric cable



Technical data	
20 A	32 A
Number of phases	1
Rated voltage	250 V AC
Rated current	20 A
Standards	IEC 62196-2
Charging mode	Mode 3, Case B
Ambient temperature (operation)	-30°C ... 50°C
Number of power contacts	3 (L1, N, PE)
Insertion/withdrawal cycles	> 10,000
Insertion/withdrawal force	< 100 N
Degree of protection (when plugged in)	IP44
Degree of protection (with protective cap)	IP54
Cable data	
Cable type	spiraled
Cable length	4 m
Cable diameter	10.2 mm ±0,3 mm
Cable structure	3 x 2,5 mm ² + 1 x 0,5 mm ²
Sheath color	black

Ordering data			
Order No.	Pcs./Pkt.	Order No.	Pcs./Pkt.
20 A		32 A	
1627131	1	1627133	1

Accessories			
Type	Order No.	Pcs./Pkt.	
EV-T2AC-PARK	1624148	1	
EV-T2M3SE12-1AC32A-0,7M6,0E10	1628124	1	



Technical data	
20 A	32 A
Number of phases	1
Rated voltage	250 V AC
Rated current	20 A
Standards	IEC 62196-2
Charging mode	Mode 3, Case B
Ambient temperature (operation)	-30°C ... 50°C
Number of power contacts	3 (L1, N, PE)
Insertion/withdrawal cycles	> 10,000
Insertion/withdrawal force	< 100 N
Degree of protection (when plugged in)	IP44
Degree of protection (with protective cap)	IP54
Cable data	
Cable type	straight
Cable length	5 m
Cable diameter	10.2 mm ±0,3 mm
Cable structure	3 x 2,5 mm ² + 1 x 0,5 mm ²
Sheath color	black

Ordering data			
Order No.	Pcs./Pkt.	Order No.	Pcs./Pkt.
20 A		32 A	
1627982	1	1627801	1

Accessories			
Type	Order No.	Pcs./Pkt.	
EV-T2AC-PARK	1624148	1	
EV-T2M3SE12-1AC32A-0,7M6,0E10	1628124	1	

Description

Mobile AC charging cable with type 2 AC vehicle charging connector and type 2 infrastructure charging plug without additional locking option with padlock

Description

Holder
Without vehicle charging connector recognition

AC infrastructure charging outlet with locking actuator (12 V operating voltage)
1-phase

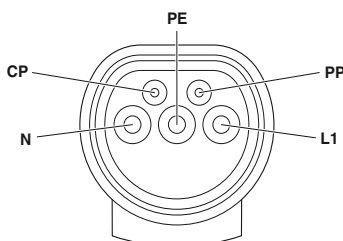

Vehicle charging connector pin assignment

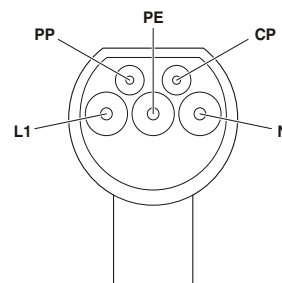

Infrastructure charging plug pin assignment



3-phase, gray-black,
with a spiraled metric cable



3-phase, gray-black,
with a straight metric cable



Technical data	
20 A	32 A
3	3
480 V AC	480 V AC
20 A	32 A
IEC 62196-2	IEC 62196-2
Mode 3, Case B	Mode 3, Case B
-30°C ... 50°C	-30°C ... 50°C
5 (L1, L2, L3, N, PE)	5 (L1, L2, L3, N, PE)
> 10,000	> 10,000
< 100 N	< 100 N
IP44	IP44
IP54	IP54
spiraled	spiraled
4 m	4 m
12.8 mm ±0.4 mm	17 mm ±0.4 mm
5 x 2.5 mm ² + 1 x 0.5 mm ²	5 x 6.0 mm ² + 1 x 0.5 mm ²
black	black

Technical data	
20 A	32 A
3	3
480 V AC	480 V AC
20 A	32 A
IEC 62196-2	IEC 62196-2
Mode 3, Case B	Mode 3, Case B
-30°C ... 50°C	-30°C ... 50°C
5 (L1, L2, L3, N, PE)	5 (L1, L2, L3, N, PE)
> 10,000	> 10,000
< 100 N	< 100 N
IP44	IP44
IP54	IP54
straight	straight
5 m	5 m
12.8 mm ±0.4 mm	17 mm ±0.4 mm
5 x 2.5 mm ² + 1 x 0.5 mm ²	5 x 6.0 mm ² + 1 x 0.5 mm ²
black	black

Ordering data			
Order No.	Pcs./Pkt.	Order No.	Pcs./Pkt.
20 A		32 A	
1627135	1	1627136	1

Ordering data			
Order No.	Pcs./Pkt.	Order No.	Pcs./Pkt.
20 A		32 A	
1628348	1	1627692	1

Accessories			
Type	Order No.	Pcs./Pkt.	
EV-T2AC-PARK	1624148	1	
EV-T2M3SE12-1AC32A-0,7M6,0E10	1628124	1	

Accessories			
Type	Order No.	Pcs./Pkt.	
EV-T2AC-PARK	1624148	1	
EV-T2M3SE12-1AC32A-0,7M6,0E10	1628124	1	

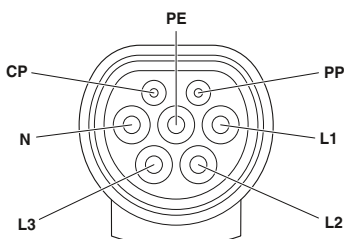

Vehicle charging connector pin assignment

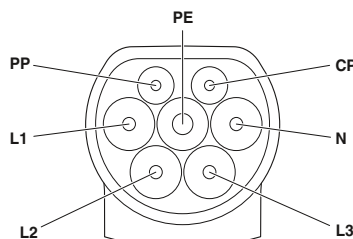

Infrastructure charging plug pin assignment

Charging connection systems

AC charging cables

Mobile type 2 design

- Mobile charging cables for European charging infrastructure
- Vehicle- and infrastructure-side locking mechanism with electromechanical locking actuator
- Vehicle charging connector and infrastructure charging plug with protective cap

Notes:
Upon request, we can also supply charging connectors with your company logo, as well as further cable types and lengths.



1-phase, black,
with a straight metric cable



3-phase, black,
with a straight metric cable



Technical data	
20 A	32 A
Number of phases	1
Rated voltage	250 V AC
Rated current	20 A
Standards	IEC 62196-2
Charging mode	Mode 3, Case B
Ambient temperature (operation)	-30°C ... 50°C
Number of power contacts	3 (L1, N, PE)
Insertion/withdrawal cycles	> 10,000
Insertion/withdrawal force	< 100 N
Degree of protection (when plugged in)	IP44
Degree of protection (with protective cap)	IP54
Cable data	
Cable type	straight
Cable length	5 m
Cable diameter	10.2 mm ±0.3 mm
Cable structure	3 x 2.5 mm ² + 1 x 0.5 mm ²
Sheath color	black

Ordering data			
Order No.	Pcs./Pkt.	Order No.	Pcs./Pkt.
	20 A		32 A

1097301 1 1097306 1

Accessories		
Type	Order No.	Pcs./Pkt.
EV-T2AC-PARK	1624148	1
EV-T2M3SE12-1AC32A-0,7M6,0E10	1628124	1



Technical data	
20 A	32 A
Number of phases	3
Rated voltage	480 V AC
Rated current	20 A
Standards	IEC 62196-2
Charging mode	Mode 3, Case B
Ambient temperature (operation)	-30°C ... 50°C
Number of power contacts	5 (L1, L2, L3, N, PE)
Insertion/withdrawal cycles	> 10,000
Insertion/withdrawal force	< 100 N
Degree of protection (when plugged in)	IP44
Degree of protection (with protective cap)	IP54
Cable data	
Cable type	straight
Cable length	5 m
Cable diameter	12.8 mm ±0.4 mm
Cable structure	5 x 2.5 mm ² + 1 x 0.5 mm ²
Sheath color	black

Ordering data			
Order No.	Pcs./Pkt.	Order No.	Pcs./Pkt.
	20 A		32 A

1097299 1 1628125 1

Accessories		
Type	Order No.	Pcs./Pkt.
EV-T2AC-PARK	1624148	1
EV-T2M3SE12-3AC32A-0,7M6,0E10	1405214	1

Description
Mobile AC charging cable with type 2 AC vehicle charging connector and type 2 infrastructure charging plug

Description
Holder
Without vehicle charging connector recognition
AC infrastructure charging outlet with locking actuator (12 V operating voltage)
1-phase
3-phase

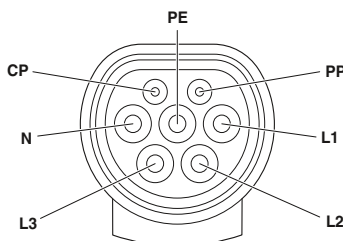

Vehicle charging connector pin assignment

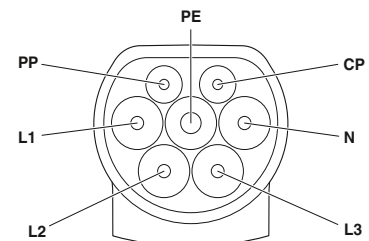

Infrastructure charging plug pin assignment

Mobile GB/T design

- Mobile charging cables for the Chinese charging infrastructure
- Vehicle- and infrastructure-side locking mechanism with lever locking
- Additional locking option with padlock
- Vehicle charging connector and infrastructure charging plug with protective cap

Notes:
Upon request, we can also supply charging connectors with your company logo, as well as further cable types and lengths.



1-phase, gray-black, with a straight metric cable



3-phase, gray-black, with a straight metric cable

Technical data		
	16 A	32 A
Number of phases	1	1
Rated voltage	250 V	250 V
Rated current	16 A	32 A
Standards	GB/T 20234.2-2015	GB/T 20234.2-2015
Charging mode	Mode 3, Case B	Mode 3, Case B
Ambient temperature (operation)	-30°C ... 50°C	-30°C ... 50°C
Number of power contacts	3 (L, N, PE)	3 (L, N, PE)
Insertion/withdrawal cycles	> 10,000	> 10,000
Insertion/withdrawal force	< 100 N	< 100 N
Degree of protection (when plugged in)	IP55	IP55
Degree of protection (with protective cap)	IP54	IP54
Cable data		
Cable type	straight	straight
Cable length	5 m	5 m
Cable diameter	10.2 mm ±0.3 mm	12.8 mm ±0.4 mm
Cable structure	3 x 2.5 mm ² + 1 x 0.5 mm ²	3 x 6.0 mm ² + 1 x 0.5 mm ²
Sheath color	black	black

Technical data		
	16 A	32 A
Number of phases	3	3
Rated voltage	440 V	440 V
Rated current	16 A	32 A
Standards	GB/T 20234.2-2015	GB/T 20234.2-2015
Charging mode	Mode 3, Case B	Mode 3, Case B
Ambient temperature (operation)	-30°C ... 50°C	-30°C ... 50°C
Number of power contacts	5 (L1, L2, L3, N, PE)	5 (L1, L2, L3, N, PE)
Insertion/withdrawal cycles	> 10,000	> 10,000
Insertion/withdrawal force	< 100 N	< 100 N
Degree of protection (when plugged in)	IP55	IP55
Degree of protection (with protective cap)	IP54	IP54
Cable data		
Cable type	straight	straight
Cable length	5 m	5 m
Cable diameter	12.8 mm ±0.4 mm	17 mm ±0.4 mm
Cable structure	5 x 2.5 mm ² + 1 x 0.5 mm ²	5 x 6.0 mm ² + 1 x 0.5 mm ²
Sheath color	black	black

Ordering data				
Description	Order No.	Pcs./Pkt.	Order No.	Pcs./Pkt.
	16 A		32 A	
Mobile AC charging cable with a GB/T AC vehicle charging connector and a GB/T infrastructure charging plug	1627603	1	1627605	1
without additional locking option with padlock	1623515	1	1623516	1
with additional locking option with padlock				

Ordering data				
Description	Order No.	Pcs./Pkt.	Order No.	Pcs./Pkt.
	16 A		32 A	
Mobile AC charging cable with a GB/T AC vehicle charging connector and a GB/T infrastructure charging plug	1627604	1	1627606	1
without additional locking option with padlock	1623517	1	1624138	1
with additional locking option with padlock				

Accessories			
Description	Type	Order No.	Pcs./Pkt.
Holder			
Without vehicle charging connector recognition	EV-GBAC-PARK	1624142	1
AC infrastructure charging outlet with locking actuator (12 V operating voltage)			
1-phase	EV-GBM3SL12-1AC32A-0,7M6,0E10T	1039245	1
3-phase			

Accessories			
Description	Type	Order No.	Pcs./Pkt.
Holder			
Without vehicle charging connector recognition	EV-GBAC-PARK	1624142	1
AC infrastructure charging outlet with locking actuator (12 V operating voltage)			
1-phase			
3-phase	EV-GBM3SL12-3AC32A-0,7M6,0E10T	1050941	1

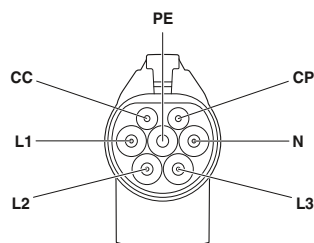

Vehicle charging connector pin assignment

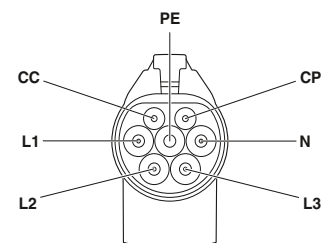

Infrastructure charging plug pin assignment

Charging connection systems

AC charging cables

Adapter charging cables

- For charging at European type 2 and Chinese GB/T charging stations
- Locking mechanism with lever locking for type 1 and GB/T
- Locking mechanism with electromechanical locking actuator for type 2
- Additional locking option with padlock for type 1 and GB/T
- Vehicle charging connector and infrastructure charging plug with protective cap

Notes:
Upon request, we can also supply charging connectors with your company logo, as well as further cable types and lengths.



Type 1 (vehicle) to type 2 (infrastructure), 1-phase, gray-black, with a spiraled metric cable



Type 1 (vehicle) to type 2 (infrastructure), 1-phase, gray-black, with a straight metric cable



Number of phases
Rated voltage
Rated current
Standards
Charging mode
Resistor coding

Ambient temperature (operation)
Number of power contacts
Insertion/withdrawal cycles
Insertion/withdrawal force
Degree of protection (when plugged in)
Degree of protection (with protective cap)

Cable data
Cable type
Cable length
Cable diameter
Cable structure
Sheath color

Technical data	
20 A	32 A
1	1
250 V AC	250 V AC
20 A	32 A
IEC 62196-2	IEC 62196-2
Mode 3, Case B	Mode 3, Case B
480 Ω (Lever actuated) 150 Ω (Lever not actuated)	480 Ω (Lever actuated) 150 Ω (Lever not actuated)
-30°C ... 50°C	-30°C ... 50°C
3 (L1, N, PE)	3 (L1, N, PE)
> 10,000	> 10,000
< 75 N	< 75 N
IP44	IP44
IP54	IP54
spiraled	spiraled
4 m	4 m
10.2 mm ±0.3 mm	12.8 mm ±0.4 mm
3 x 2.5 mm ² + 1 x 0.5 mm ²	3 x 6.0 mm ² + 1 x 0.5 mm ²
black	black

Technical data	
20 A	32 A
1	1
250 V AC	250 V AC
20 A	32 A
IEC 62196-2	IEC 62196-2
Mode 3, Case B	Mode 3, Case B
480 Ω (Lever actuated) 150 Ω (Lever not actuated)	480 Ω (Lever actuated) 150 Ω (Lever not actuated)
-30°C ... 50°C	-30°C ... 50°C
3 (L1, N, PE)	3 (L1, N, PE)
> 10,000	> 10,000
< 75 N	< 75 N
IP44	IP44
IP54	IP54
straight	straight
5 m	5 m
10.2 mm ±0.3 mm	12.8 mm ±0.4 mm
3 x 2.5 mm ² + 1 x 0.5 mm ²	3 x 6.0 mm ² + 1 x 0.5 mm ²
black	black

Description

Mobile AC adapter cable with a vehicle charging connector and an infrastructure charging plug
without additional locking option with padlock

with additional locking option with padlock

Ordering data			
Order No.	Pcs./Pkt.	Order No.	Pcs./Pkt.
20 A		32 A	
1628025	1	1628026	1
1628020	1	1628021	1

Ordering data			
Order No.	Pcs./Pkt.	Order No.	Pcs./Pkt.
20 A		32 A	
1628027	1	1628028	1
1628022	1	1628023	1

Description

Holder
Without vehicle charging connector recognition
AC infrastructure charging outlet with locking actuator (12 V operating voltage)
1-phase
3-phase

Accessories		
Type	Order No.	Pcs./Pkt.
EV-T1AC-PARK	1624139	1
EV-T2M3SE12-1AC32A-0,7M6,0E10	1628124	1

Accessories		
Type	Order No.	Pcs./Pkt.
EV-T1AC-PARK	1624139	1
EV-T2M3SE12-1AC32A-0,7M6,0E10	1628124	1

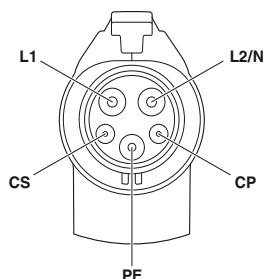

Type 1 vehicle charging connector pin assignment

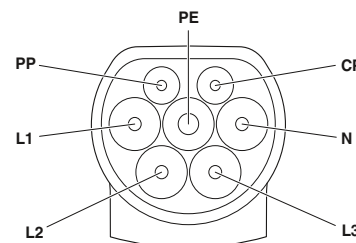

Type 2 infrastructure charging plug pin assignment



Type 1 (vehicle) to GB/T (infrastructure), 1-phase, gray-black, with a straight metric cable



Type 2 (vehicle) to GB/T (infrastructure), 1-phase, gray-black, with a straight metric cable



GB/T (vehicle) to type 2 (infrastructure), gray-black, with a straight metric cable

Technical data	
16 A	32 A
1	1
250 V	250 V AC
16 A	32 A
GB/T 20234.2-2015	GB/T 20234.2-2015
Mode 3, Case B	Mode 3, Case B
680 Ω + 2.7 kΩ (Lever actuated)	480 Ω (Lever actuated)
680 Ω (Lever not actuated)	150 Ω (Lever not actuated)
-30°C ... 50°C	-30°C ... 50°C
3 (L1, N, PE)	3 (L1, N, PE)
> 10,000	> 10,000
< 75 N	< 75 N
IP44	IP44
IP54	IP54
straight	straight
5 m	5 m
10.2 mm ±0.3 mm	12.8 mm ±0.4 mm
3 x 2.5 mm ² + 1 x 0.5 mm ²	3 x 6.0 mm ² + 1 x 0.5 mm ²
black	black

Technical data	
32 A	
1	
250 V	
32 A	
IEC 62196-2	
Mode 3, Case B	
220 Ω + 3...3 kΩ (Lever actuated)	
220 Ω (Lever not actuated)	
-30°C ... 50°C	
3 (L, N, PE)	
> 10,000	
< 100 N	
IP55	
IP54	
straight	
5 m	
12.8 mm ±0.4 mm	
3 x 6.0 mm ² + 1 x 0.5 mm ²	
black	

Technical data	
32 A, 1-phase	32 A, 3-phase
1	3
250 V	440 V
32 A	32 A
IEC 62196-2	IEC 62196-2
Mode 3, Case B	Mode 3, Case B
220 Ω + 3...3 kΩ (Lever actuated)	220 Ω + 3...3 kΩ (Lever actuated)
220 Ω (Lever not actuated)	220 Ω (Lever not actuated)
-30°C ... 50°C	-30°C ... 50°C
3 (L, N, PE)	5 (L1, L2, L3, N, PE)
> 10,000	> 10,000
< 100 N	< 100 N
IP55	IP55
IP54	IP54
straight	straight
5 m	5 m
12.8 mm ±0.4 mm	17 mm ±0.4 mm
3 x 6.0 mm ² + 1 x 0.5 mm ²	5 x 6.0 mm ² + 1 x 0.5 mm ²
black	black

Ordering data			
Order No.	Pcs./Pkt.	Order No.	Pcs./Pkt.
16 A		32 A	

Ordering data			
Order No.	Pcs./Pkt.	Order No.	Pcs./Pkt.
32 A			

Ordering data			
Order No.	Pcs./Pkt.	Order No.	Pcs./Pkt.
32 A, 1-phase		32 A, 3-phase	

1627756 1 1022285 1

1627688 1

1050702 1 1628001 1

Accessories		
Type	Order No.	Pcs./Pkt.
EV-T1AC-PARK	1624139	1
EV-GBM3SL12-1AC32A-0,7M6,0E10T	1039245	1

Accessories		
Type	Order No.	Pcs./Pkt.
EV-T2AC-PARK	1624148	1
EV-GBM3SL12-1AC32A-0,7M6,0E10T	1039245	1

Accessories		
Type	Order No.	Pcs./Pkt.
EV-GBAC-PARK	1624142	1
EV-T2M3SE12-1AC32A-0,7M6,0E10	1628124	1
EV-T2M3SE12-3AC32A-0,7M6,0E10	1405214	1

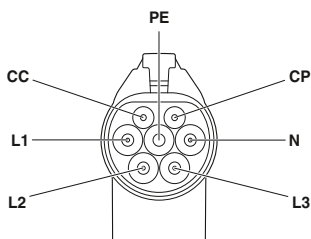

GB/T infrastructure charging plug pin assignment

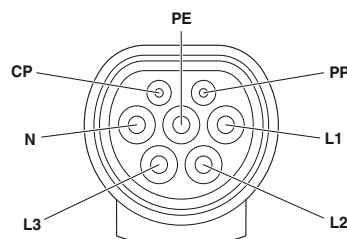

Type 2 vehicle charging connector pin assignment

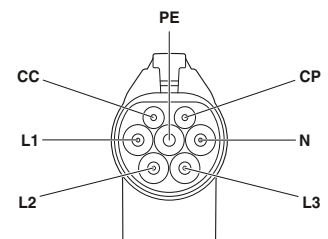

GB/T vehicle charging connector pin assignment



The ideal interface for mobile charging cables

Our standardized AC infrastructure socket outlets can be used, for example, in public AC charging stations or compact wall boxes, and allow vehicles to be charged via a mobile AC charging cable in accordance with charging mode 3, case B. This means that you achieve a significantly higher power transmission than with charging via standard household outlets.

The charging outlets are pre-assembled, compact, highly flexible, and suitable for both indoor and outdoor use. Versions are available for the European type 2 standard and for the Chinese GB/T standard. The type 1 standard for North America and Japan does not stipulate an infrastructure socket outlet.

Fast, flexible mounting

The modular, space-saving design of the infrastructure socket outlets allows for flexible front and rear mounting, even on compact wall boxes. A drainage tube and different types of protective covers can be installed as an option. We can also supply the cable end preassembled, compacted, or with a step cut upon request.

Safe charging process

Thanks to a locking actuator, the infrastructure charging plug is reliably prevented from being pulled out during the charging process. The lock is controlled via electronics integrated into the actuator, and the current status can be queried. In the event of an emergency, e.g. a power outage, the locking actuator can also be unlocked manually by opening the charging station.

Your advantages

- Comprehensive product range for type 2 and GB/T
- Also suitable for compact wall boxes, thanks to the space-saving design
- Highly flexible, thanks to the modular design for front and rear mounting
- High level of safety during the charging process, thanks to the integrated locking actuator including position recognition and manual emergency unlocking
- Efficient power transmission and long-term stability, thanks to silver-plated power and signal contacts
- No condensation issues, thanks to the integrated drainage system with discharge nozzle
- Developed and produced in accordance with the IATF 16949 automotive standard and ISO 9001

i Your web code: #2100



Type 2 charging outlets

The type 2 charging outlet in accordance with IEC 62196 is designed for single- and three-phase charging within Europe. It is available both in a modular design for front and rear mounting with rear-side protective-cover screw connections, and as an easy-mount version for rear mounting with front-side protective-cover screw connections. The advantage of the easy-mount version is that the protective cover can be replaced conveniently without having to open the wall box or charging station.



GB/T charging outlets

The charging outlet in accordance with GB/T 20234 is designed for charging in line with Chinese infrastructure. It is very similar to the type 2 charging outlet. In addition to the locking actuator, a notch is provided for the lever of the infrastructure charging plug in accordance with standards. Moreover, every power contact is equipped with integrated temperature sensors in accordance with the new GB/T standard.

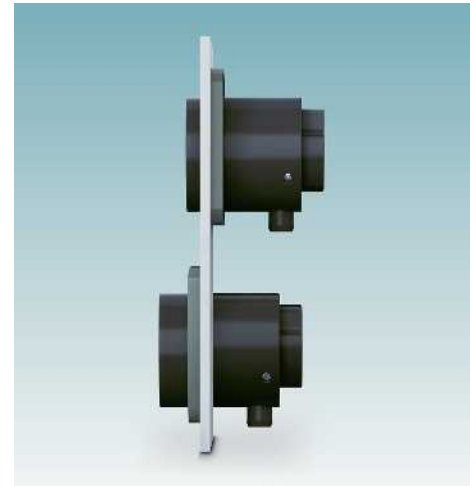

Front and rear mounting

The GB/T and type 2 infrastructure socket outlets (with the exception of the easy-mount versions) can be mounted onto the housing wall of the charging station or wall box from the front and from the back. This enables flexible use.



Matching protective cover type 2

We provide covers for protecting type 2 infrastructure socket outlets against environmental influences in accordance with IP54 and against vandalism. To ensure the consistent branding of your charging stations and wall boxes, we can provide a tailored design with your company logo upon request. The protective covers are listed in the “Accessories” section.



Matching GB/T protective covers

GB/T protective covers provide the same advantages as the type 2 protective covers, but they also vary in respect to the type of cover mechanism – self-closing or self-opening. All installation positions are possible. The protective cover can therefore be attached from the left, right, top, or bottom. The protective covers are listed in the “Accessories” section.

Charging connection systems

AC infrastructure socket outlets

Type 2

- For installation in European charging stations
- Locking by means of electromechanical locking actuator

Notes:
Further cable lengths available on request.



For protective covers
screwed on from the back



For protective covers
screwed on from the front (easy-mount)



	Technical data			Technical data		
	20 A, 3-phase	32 A, 1-phase	32 A, 3-phase	20 A, 3-phase	32 A, 1-phase	32 A, 3-phase
Number of phases	3	1	3	3	1	3
Rated voltage	480 V AC	250 V AC	480 V AC	480 V AC	250 V AC	480 V AC
Rated current	20 A	32 A	32 A	20 A	32 A	32 A
Standards	IEC 62196-2	IEC 62196-2	IEC 62196-2	IEC 62196-2	IEC 62196-2	IEC 62196-2
Charging mode	Mode 3, Case B	Mode 3, Case B	Mode 3, Case B	Mode 3, Case B	Mode 3, Case B	Mode 3, Case B
Dimensions (H x W x D)	75 mm x 96 mm x 76.2 mm	75 mm x 96 mm x 76.2 mm	75 mm x 96 mm x 76.2 mm	75 mm x 96 mm x 76.2 mm	75 mm x 96 mm x 76.2 mm	75 mm x 96 mm x 76.2 mm
Ambient temperature (operation)	-30°C ... 50°C	-30°C ... 50°C	-30°C ... 50°C	-30°C ... 50°C	-30°C ... 50°C	-30°C ... 50°C
Number of power contacts	5 (L1, L2, L3, N, PE)	3 (L1, N, PE)	5 (L1, L2, L3, N, PE)	5 (L1, L2, L3, N, PE)	3 (L1, N, PE)	5 (L1, L2, L3, N, PE)
Insertion/withdrawal cycles	> 10,000	> 10,000	> 10,000	> 10,000	> 10,000	> 10,000
Degree of protection (when plugged in)	IP44	IP44	IP44	IP44	IP44	IP44
Degree of protection (with protective cover)	IP54	IP54	IP54	IP54	IP54	IP54
Cable data						
Cable type	Single wires	Single wires	Single wires	Single wires	Single wires	Single wires
Cable length	0.7 m	0.7 m	0.7 m	0.7 m	0.7 m	0.7 m
Cable structure	5x 2.5 mm ² + 2x 0.5 mm ²	3x 6.0 mm ² + 2x 0.5 mm ²	5x 6.0 mm ² + 2x 0.5 mm ²	5x 2.5 mm ² + 2x 0.5 mm ²	3x 6.0 mm ² + 2x 0.5 mm ²	5x 6.0 mm ² + 2x 0.5 mm ²
Locking actuator data						
Mechanical emergency release	available	available	available	available	available	available
Lock recognition	available	available	available	available	available	available

Description	Ordering data			Ordering data		
	Order No.	Pcs./Pkt.	Order No.	Pcs./Pkt.	Order No.	Pcs./Pkt.
Type 2 AC infrastructure socket outlet with locking actuator (12 V operating voltage)	1405213	1	1628124	1	1405214	1
Type 2 AC infrastructure socket outlet with locking actuator (24 V operating voltage)	1405215	1			1405216	1

Description	Accessories			Accessories		
	Type	Order No.	Pcs./Pkt.	Type	Order No.	Pcs./Pkt.
Protective cover , can be fastened with screws from the back Self-closing	EV-T2SC	1405217	1			
Panel mounting frame , can be screwed on the back As an alternative to the protective cover	EV-T2SF	1405218	1			
Protective cover , can be fastened with screws horizontally from the front Self-closing				EV-T2SC-EMF	1069199	1
Protective cover , can be fastened with screws vertically from the front Self-closing				EV-T2SC-EM	1627635	1
Fixing frame , can be screwed on the front Required for protective covers with front vertical screw connection				EV-T2SF-EM	1627637	1

GB/T

- For installation in Chinese charging stations
- Locking by means of electromechanical locking actuator

Notes:
Further cable lengths available on request.



For protective covers
screwed on from the back

Number of phases	1
Rated voltage	250 V AC
Rated current	32 A
Standards	GB/T 20234.2-2015
Charging mode	Mode 3, Case B
Dimensions (H x W x D)	75 mm x 96 mm x 76.2 mm
Ambient temperature (operation)	-30°C ... 50°C
Number of power contacts	3 (L1, N, PE)
Insertion/withdrawal cycles	> 10,000
Degree of protection (when plugged in)	IP55
Degree of protection (with protective cover)	IP55
Cable data	
Cable type	Single wires
Cable length	0.7 m
Cable structure	3x 6.0 mm ² + 2x 0.5 mm ²
Locking actuator data	
Mechanical emergency release	available
Lock recognition	available

Technical data			
32 A, 1-phase		32 A, 3-phase	
Number of phases	1	3	
Rated voltage	250 V AC	440 V AC	
Rated current	32 A	32 A	
Standards	GB/T 20234.2-2015	GB/T 20234.2-2015	
Charging mode	Mode 3, Case B	Mode 3, Case B	
Dimensions (H x W x D)	75 mm x 96 mm x 76.2 mm	75 mm x 96 mm x 76.2 mm	
Ambient temperature (operation)	-30°C ... 50°C	-30°C ... 50°C	
Number of power contacts	3 (L1, N, PE)	5 (L1, L2, L3, N, PE)	
Insertion/withdrawal cycles	> 10,000	> 10,000	
Degree of protection (when plugged in)	IP55	IP55	
Degree of protection (with protective cover)	IP55	IP55	
Cable data			
Cable type	Single wires	Single wires	
Cable length	0.7 m	0.7 m	
Cable structure	3x 6.0 mm ² + 2x 0.5 mm ²	5x 6.0 mm ² + 2x 0.5 mm ²	
Locking actuator data			
Mechanical emergency release	available	available	
Lock recognition	available	available	

Description	
AC infrastructure charging outlet with locking actuator (12 V operating voltage) 1-phase	

Ordering data			
Order No.	Pcs./Pkt.	Order No.	Pcs./Pkt.
		32 A, 1-phase	
1039245	1	32 A, 3-phase	
		1050941	1

Description	
Protective cover	
Self-opening	
Self-closing	

Accessories		
Type	Order No.	Pcs./Pkt.
EV-GBSCO	1623415	1
EV-GBSC	1623416	1

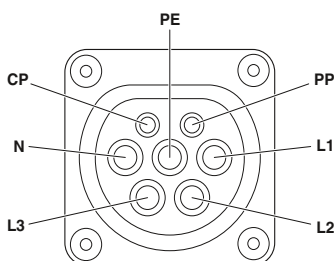

Type 2 infrastructure socket outlet pin assignment

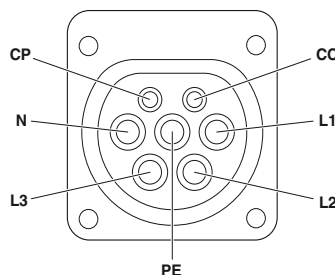

GB/T infrastructure socket outlet pin assignment



Options to benefit you

A selection of various accessories suitable for our charging cables and charging outlets is also available. You can use these to add useful functions such as advanced protection against environmental factors, or for enabling the fast and cost-effective repair of a damaged charging cable.

Your advantages

- Reliable protection for charging interfaces against environmental influences and vandalism
- Secure hold for charging connectors when vehicles are not being charged
- Consistent branding of your charging station or wall box with your company logo
- Quick and cost-effective repair of charging connectors in the event of damage
- Developed and produced in accordance with the IATF 16949 automotive standard and ISO 9001

i Your web code: [#2101](#)



Repair kits for cooled DC charging cables

Charging cables at public charging stations, and the mating face in particular, are subject to high levels of mechanical strain. Our repair kits can be used to quickly replace the mating face frames and power contacts on a damaged HPC charging connector, thereby minimizing downtime and ensuring that the costly replacement of the entire HPC charging cable is not necessary.



Holders for DC charging cables

Matching holders for DC charging cables are mounted on the outside of the charging station or wall box. They ensure the vehicle charging connector is held securely in place and protected against the elements whenever charging is not taking place.



Protective covers for AC infrastructure socket outlets

We provide covers for protecting infrastructure socket outlets against environmental influences in accordance with IP54 as well as against vandalism. To ensure the consistent branding of your charging stations and wall boxes, we can provide a tailored design with your company logo upon request.



Holders for AC charging cables

Matching holders for AC charging cables are mounted on the outside of the charging station or wall box. They ensure the vehicle charging connector is held securely in place and protected against the elements whenever charging is not taking place.

Accessories

Repair kits for cooled HPC DC charging cables

- Kits for the cost-effective repair of damaged CCS type 2 HPC charging connectors
- Allows for the replacement of the mating face frame and, optionally, DC contacts
- It is not necessary to open the housing or to drain off the coolant



Mating face frame, bit, and DC contacts, for CCS type 2

General data		Technical data		
Type		With 5x M4X10 rounded head screws with Torx safety drive With special bit for safety screwdriver With DC contact maintained with integrated front part of DC contacts and their temperature sensors		
Standards		IEC 62196-3-1		
Charging standard		CCS type 2 Combined Charging System High Power Charging		
Charging mode		Mode 4		
Color		black		
Ambient temperature (operation)		-30°C ... 50°C		
Ambient temperature (storage/transport)		-40°C ... 80°C		
Description		Ordering data		
Repair kit		Type	Order No.	Pcs./Pkt.
		EV-T2CCS-MF-M4X10-BIT-CTS	1085799	1



Mating face frame and bit,
for CCS type 2



Mating face frame,
for CCS type 2

Technical data

With 5x M4X10 rounded head screws with Torx safety drive
With special bit for safety screwdriver

IEC 62196-3-1
CCS type 2
Combined Charging System
High Power Charging
Mode 4
black
-30°C ... 50°C
-40°C ... 80°C

Technical data

With 5x M4X10 rounded head screws with Torx safety drive

IEC 62196-3-1
CCS type 2
Combined Charging System
High Power Charging
Mode 4
black
-30°C ... 50°C
-40°C ... 80°C

Ordering data

Type	Order No.	Pcs./Pkt.
EV-T2CCS-MF-M4X10-BIT	1085798	1

Ordering data

Type	Order No.	Pcs./Pkt.
EV-T2CCS-MF-M4X10	1085797	1

Holders for DC charging cables

- Park position for vehicle charging connector
- For mounting on charging stations
- Stable vehicle charging connector parking

Notes:
The screw connection positions on all holders listed here are identical



CCS type 1

Standards
Charging standard
Charging mode
Color
Dimensions (H x W x D)
Mounting
Fixing of vehicle charging connector
Removal of vehicle charging connector
Ambient temperature (operation)
Ambient temperature (storage/transport)
Degree of protection (when plugged in)

Technical data	
SAE J1772	CCS type 1
Mode 4	black
75 mm x 118 mm x 37.5 mm	Front mounting
With actuation lever	Lever actuation and removal
-30°C ... 50°C	-40°C ... 80°C
IP54	

Description
Holder
Without vehicle charging connector recognition
With vehicle charging connector recognition
Fixing with hexagonal head screws

Ordering data		
Type	Order No.	Pcs./Pkt.
EV-T1CCS-PARK	1624143	1



CCS type 2



GB/T

Technical data

IEC 62196-3
 CCS type 2
 Mode 4
 black
 75 mm x 118 mm x 54 mm
 Front mounting
 With locking clips for locking contour
 Lifting and removal
 -30°C ... 50°C
 -40°C ... 80°C
 IP54

Technical data

GB/T 20234.3
 GB/T
 Mode 4
 black
 91 mm x 91 mm x 51 mm
 Front mounting
 With actuation lever
 Lever actuation and removal
 -30°C ... 50°C
 -40°C ... 80°C
 IP54

Ordering data

Type	Order No.	Pcs./Pkt.
EV-T2CCS-PARK	1624153	1

Ordering data

Type	Order No.	Pcs./Pkt.
EV-GBDC-PARK	1623770	1
EV-GBDC-PARK-SW	1623497	1
EV-GBDC-PARK-R	1623496	1

Holders for AC charging cables

- Park position for vehicle charging connector
- For mounting on charging stations
- Stable vehicle charging connector parking

Notes:
The screw connection positions on all holders listed here are identical
The screw connection positions correspond to the AC infrastructure socket outlets



Type 1

Standards	SAE J1772
Charging standard	Type 1
Charging mode	Mode 3
Color	black
Dimensions (H x W x D)	75 mm x 75 mm x 37.5 mm
Mounting	Front mounting
Fixing of vehicle charging connector	With actuation lever
Removal of vehicle charging connector	Lever actuation and removal
Ambient temperature (operation)	-30°C ... 50°C
Ambient temperature (storage/transport)	-40°C ... 80°C
Degree of protection (when plugged in)	IP54

Technical data

Standards	SAE J1772
Charging standard	Type 1
Charging mode	Mode 3
Color	black
Dimensions (H x W x D)	75 mm x 75 mm x 37.5 mm
Mounting	Front mounting
Fixing of vehicle charging connector	With actuation lever
Removal of vehicle charging connector	Lever actuation and removal
Ambient temperature (operation)	-30°C ... 50°C
Ambient temperature (storage/transport)	-40°C ... 80°C
Degree of protection (when plugged in)	IP54

Description
Holder
Without vehicle charging connector recognition

Ordering data

Type	Order No.	Pcs./Pkt.
EV-T1AC-PARK	1624139	1



Type 2



GB/T

Technical data

IEC 62196-2
 Type 2
 Mode 3
 black
 75 mm x 75 mm x 44.7 mm
 Front mounting
 With locking clips for locking contour
 Lifting and removal
 -30°C ... 50°C
 -40°C ... 80°C
 IP54

Technical data

GB/T 20234.2
 GB/T
 Mode 3
 black
 76.6 mm x 76.6 mm x 40 mm
 Front mounting
 With actuation lever
 Lever actuation and removal
 -30°C ... 50°C
 -40°C ... 80°C
 IP54

Ordering data

Type	Order No.	Pcs./Pkt.
EV-T2AC-PARK	1624148	1

Ordering data

Type	Order No.	Pcs./Pkt.
EV-GBAC-PARK	1624142	1

Accessories

Protective covers for type 2 AC infrastructure socket outlets

Two versions are available for increasing the degree of protection of type 2 AC infrastructure socket outlets to IP54:

- Protective cover with rear screw connection
- Protective cover with front screw connection, easy to replace



Protective cover that can be screwed on the back, with alternative panel mounting frame



Protective cover that can be screwed on the front, with fixing frame

Standards
Charging standard
Charging mode
Color
Dimensions (H x W x D)
Ambient temperature (operation)

Technical data		
Standards	IEC 62196-2	
Charging standard	Type 2	
Charging mode	Mode 3, Case B	
Color	black	
Dimensions (H x W x D)	85 mm x 93.7 mm x 32.5 mm	
Ambient temperature (operation)	-30°C ... 50°C	

Technical data		
Standards	IEC 62196-2	
Charging standard	Type 2	
Charging mode	Mode 3, Case B	
Color	black	
Dimensions (H x W x D)	85 mm x 93.7 mm x 32.5 mm	
Ambient temperature (operation)	-30°C ... 50°C	

Description

Protective cover, can be fastened with screws from the back
Self-closing

Panel mounting frame, can be screwed on the back
As an alternative to the protective cover

Protective cover, can be fastened with screws horizontally from the front
Self-closing

Protective cover, can be fastened with screws vertically from the front
Self-closing

Fixing frame, can be screwed on the front

Required for protective covers with front vertical screw connection

Ordering data		
Type	Order No.	Pcs./Pkt.
EV-T2SC	1405217	1
EV-T2SF	1405218	1

Ordering data		
Type	Order No.	Pcs./Pkt.
EV-T2SC-EMF	1069199	1
EV-T2SC-EM	1627635	1
EV-T2SF-EM	1627637	1

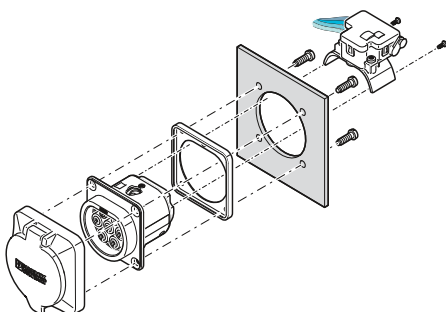

Front mounting of the infrastructure socket outlet with locking actuator removed

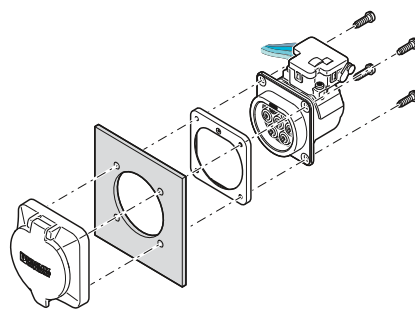

Rear panel mounting of the infrastructure socket outlet, protective cover screwed on the back

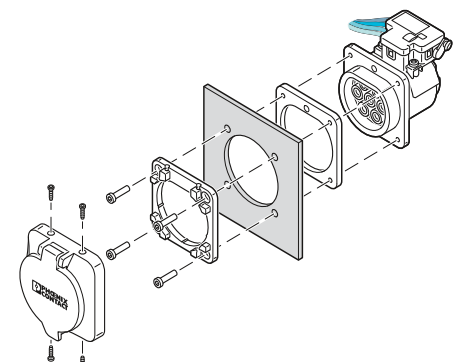

Rear panel mounting of the infrastructure socket outlet, protective cover screwed on the front

Protective covers for GB/T AC infrastructure socket outlets

Two versions are available for increasing the degree of protection of GB/T AC infrastructure socket outlets to IP54:

- Protective cover, self-opening
- Protective cover, self-closing



Protective cover that can be screwed on the back, self-opening



Protective cover that can be screwed on the back, self-closing

Standards
Charging standard

Charging mode
Color
Dimensions (H x W x D)
Ambient temperature (operation)

Technical data		
Standards	GB/T 20234.2	
Charging standard	GB/T Type 2	
Charging mode	Mode 3, Case B	
Color	black	
Dimensions (H x W x D)	76.6 mm x 90.5 mm x 24.7 mm	
Ambient temperature (operation)	-30°C ... 50°C	

Ordering data		
Type	Order No.	Pcs./Pkt.
EV-GBSCO	1623415	1

Description

Protective cover
Self-opening
Self-closing

Technical data		
Standards	GB/T 20234.2	
Charging standard	GB/T Type 2	
Charging mode	Mode 3, Case B	
Color	black	
Dimensions (H x W x D)	76.6 mm x 76.6 mm x 24.7 mm	
Ambient temperature (operation)	-30°C ... 50°C	

Ordering data		
Type	Order No.	Pcs./Pkt.
EV-GBSC	1623416	1

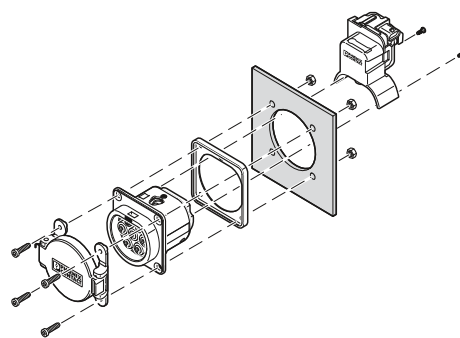

Front mounting of the infrastructure socket outlet with locking actuator removed



The ideal charging interface

The universal CCS vehicle inlets allow for fast DC and conventional AC charging with just one mating face. This covers all charging situations. The inlets can accommodate both AC and DC vehicle charging connectors, making them the ideal interface for charging all types of electric vehicles. Various power versions with 12 V or 24 V locking actuators are available, which makes it possible to use them with a variety of applications.

Along with the CCS vehicle inlets, we also provide DC inlets in accordance with the Chinese GB/T standard.

Uniform dimensions

The CCS vehicle inlets feature uniform outer contour dimensions. This allows electric vehicle manufacturers to provide for the same installation space in the car body. A vehicle inlet for the North American market (CCS type 1) fits just as well as an inlet for the European market (CCS type 2).

Important note

These products are exclusively developed, manufactured, and distributed by PHOENIX CONTACT electromobility GmbH.

Interested? Do you have any questions? Please contact our Sales Team at emobility@phoenixcontact.com or by phone on +49 5235 3-43890.

Your advantages

- Quick-response sensor technology provides fast and accurate temperature measurement at all contacts
- Efficient power transmission and long-term stability, thanks to silver-plated contact surfaces
- Uniform dimensions in terms of installation space, screw-connection points, and outer contour (CCS inlets only)
- With protective caps for the AC and DC contacts (CCS inlets only)
- Developed and produced in accordance with the IATF 16949 automotive standard and ISO 9001
- Tested in accordance with selected tests from automotive standards LV124, LV214, LV215-2, GB/T

i Your web code: #2090



CCS type 1

These vehicle inlets are suitable for charging electric vehicles with alternating current (AC) and direct current (DC) in accordance with the American standard CCS type 1. The charging connector is locked in place during charging via an electromechanical actuator.



CCS type 2

These vehicle inlets are suitable for charging electric vehicles with alternating current (AC) and direct current (DC) in accordance with the European standard CCS type 2. The charging connector is locked in place during charging via an electromechanical actuator.



GB/T

These vehicle inlets are suitable for charging electric vehicles with direct current (DC) in accordance with the Chinese standard GB/T.

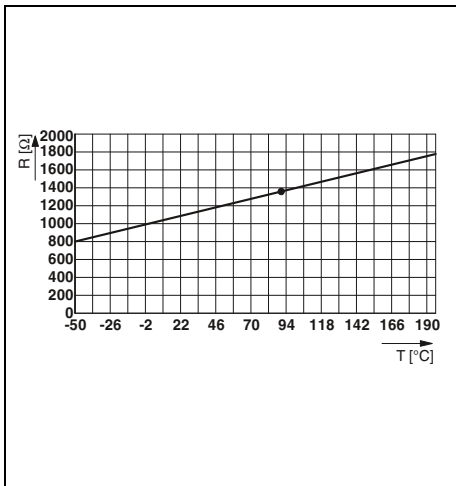

High-precision temperature measuring

The temperature at the power contacts must also be monitored to ensure a safe charging process. If the system overheats, for example in the event of high outside temperatures or an overload, this is detected by the PT1000 resistance sensors. In the event of overheating, the charging controller is then able to stop the charging process or reduce the charging power.



Secure locking during charging

The CCS vehicle inlets are equipped with an electromechanical locking actuator in accordance with standards. It locks the vehicle charging connector on the side of or directly on the locking clip in the mating face during the charging process. The actuator bolt is designed to withstand high pull-out forces. It is therefore not possible to pull out the charging connector during the charging process.



Developing customer-specific inlets

We develop inlets for your series vehicle production in accordance with your requirements. We can integrate functions such as LED displays, lighting, operating elements, and locking mechanisms. Thanks to our intelligent cooling concepts and a high-precision temperature measurement system, we are able to reduce the conductor cross sections, thus reducing the costs of the overall charging connection system.

Charging connection systems

Vehicle inlets

CCS type 2

- Vehicle inlets for charging with alternating current (AC) and direct current (DC)
- European standard (CCS type 2)
- For installation in electric vehicles
- Locking by means of electromechanical locking actuator
- Additional cable lengths available on request



125 A DC, 20 A AC



125 A DC, 32 A AC

Notes:
 These products are exclusively developed, manufactured, and distributed by PHOENIX CONTACT electromobility GmbH. Interested? Do you have any questions? Please contact our Sales Team at emobility@phoenixcontact.com or by phone on +49 5235 3-43890.

	Technical data				Technical data			
	1-phase		3-phase		1-phase		3-phase	
Number of phases	1		3		1		3	
Rated voltage	250 V AC 850 V DC		480 V AC 850 V DC		250 V AC 850 V DC		480 V AC 850 V DC	
Rated current	20 A AC 125 A DC		20 A AC 125 A DC		32 A AC 125 A DC		32 A AC 125 A DC	
Standards	IEC 62196-3		IEC 62196-3		IEC 62196-3		IEC 62196-3	
Charging mode	Mode 2, 3, 4		Mode 2, 3, 4		Mode 2, 3, 4		Mode 2, 3, 4	
Dimensions (H x W x D)	111 mm x 130.4 mm x 107.4 mm		111 mm x 130.4 mm x 107.4 mm		111 mm x 130.4 mm x 107.4 mm		111 mm x 130.4 mm x 107.4 mm	
Ambient temperature (operation)	-30°C ... 50°C		-30°C ... 50°C		-30°C ... 50°C		-30°C ... 50°C	
Number of power contacts	5 (L1, N, PE, DC+, DC-)		7 (L1, L2, L3, N, PE, DC+, DC-)		5 (L1, N, PE, DC+, DC-)		7 (L1, L2, L3, N, PE, DC+, DC-)	
Insertion/withdrawal cycles	> 10,000		> 10,000		> 10,000		> 10,000	
Degree of protection (when plugged in)	IP55		IP55		IP55		IP55	
Degree of protection (with protective cover)	IP55		IP55		IP55		IP55	
Cable data								
Cable length	2 m		2 m		2 m		2 m	
Cable structure	2 x 35 mm ² + 1 x 25 mm ² + 2 x 2.5 mm ² + 3 x 2 x 0.5 mm ²		2 x 35 mm ² + 1 x 25 mm ² + 4 x 2.5 mm ² + 3 x 2 x 0.5 mm ²		2 x 35 mm ² + 1 x 25 mm ² + 2 x 6 mm ² + 3 x 2 x 0.5 mm ²		2 x 35 mm ² + 1 x 25 mm ² + 4 x 6 mm ² + 2 x 0.5 mm ² + 4 x 0.5 mm ²	
Locking actuator data								
Mechanical emergency release	included		included		included		included	
Lock recognition	included		included		included		included	
Ordering data								
Description	Order No.	Pcs./Pkt.	Order No.	Pcs./Pkt.	Order No.	Pcs./Pkt.	Order No.	Pcs./Pkt.
	1-phase		3-phase		1-phase		3-phase	
Vehicle inlet for charging with alternating current (AC) and direct current (DC), for installation in electric vehicles (EV)								
With locking actuator (12 V operating voltage)	1624131	1	1628386	1	1628385	1	1627096	1
With locking actuator (24 V operating voltage)	1004840	1	1018763	1	1018767	1	1004844	1

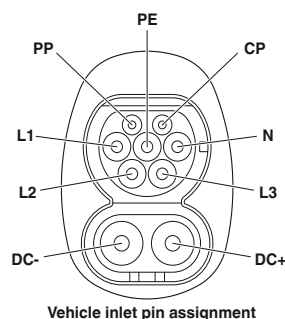



200 A DC, 20 A AC



200 A DC, 32 A AC

Technical data				Technical data			
1-phase		3-phase		1-phase		3-phase	
1		3		1		3	
250 V AC		480 V AC		250 V AC		480 V AC	
850 V DC		850 V DC		850 V DC		850 V DC	
20 A AC		200 A DC		200 A DC		200 A DC	
200 A DC		32 A AC		32 A AC		32 A AC	
IEC 62196-3		IEC 62196-3		IEC 62196-3		IEC 62196-3	
Mode 2, 3, 4		Mode 2, 3, 4		Mode 2, 3, 4		Mode 2, 3, 4	
111 mm x 130.4 mm x 107.4 mm		111 mm x 130.4 mm x 107.4 mm		111 mm x 130.4 mm x 107.4 mm		111 mm x 130.4 mm x 107.4 mm	
-30°C ... 50°C		-30°C ... 50°C		-30°C ... 50°C		-30°C ... 50°C	
5 (L1, N, PE, DC+, DC-)		7 (L1, L2, L3, N, PE, DC+, DC-)		5 (L1, N, PE, DC+, DC-)		7 (L1, L2, L3, N, PE, DC+, DC-)	
> 10,000		> 10,000		> 10,000		> 10,000	
IP55		IP55		IP55		IP55	
IP55		IP55		IP55		IP55	
2 m		2 m		2 m		2 m	
2 x 70 mm ² + 1 x 25 mm ² + 2 x 2.5 mm ² + 2 x 0.5 mm ² + 4 x 0.5 mm ²		2 x 70 mm ² + 1 x 25 mm ² + 4 x 2.5 mm ² + 2 x 0.5 mm ² + 4 x 0.5 mm ²		2 x 70 mm ² + 1 x 25 mm ² + 2 x 6 mm ² + 2 x 0.5 mm ² + 4 x 0.5 mm ²		2 x 70 mm ² + 1 x 25 mm ² + 4 x 6 mm ² + 2 x 0.5 mm ² + 4 x 0.5 mm ²	
included		included		included		included	
included		included		included		included	
Ordering data				Ordering data			
Order No.	Pcs./Pkt.	Order No.	Pcs./Pkt.	Order No.	Pcs./Pkt.	Order No.	Pcs./Pkt.
1-phase		3-phase		1-phase		3-phase	
1628340	1	1628387	1	1018771	1	1627097	1
1004802	1	1004842	1	1018762	1	1004841	1

Charging connection systems

Vehicle inlets

CCS type 1

- Vehicle inlets for charging with alternating current (AC) and direct current (DC)
- North American standard (CCS type 1)
- For installation in electric vehicles
- Locking by means of electromechanical locking actuator
- Additional cable lengths available on request



125 A DC



200 A DC

Notes:
 These products are exclusively developed, manufactured, and distributed by PHOENIX CONTACT electromobility GmbH. Interested? Do you have any questions? Please contact our Sales Team at emobility@phoenixcontact.com or by phone on +49 5235 3-43890.

	Technical data		Technical data	
	20 A AC	32 A AC	20 A AC	32 A AC
Number of phases	1	1	1	1
Rated voltage	250 V AC 850 V DC	250 V AC 850 V DC	250 V AC 850 V DC	250 V AC 850 V DC
Rated current	20 A AC 125 A DC	32 A AC 125 A DC	20 A AC 200 A DC	32 A AC 200 A DC
Standards	SAE J1772	SAE J1772	SAE J1772	SAE J1772
Charging mode	Mode 2, 3, 4	Mode 2, 3, 4	Mode 2, 3, 4	Mode 2, 3, 4
Dimensions (H x W x D)	111 mm x 130.6 mm x 107.4 mm	111 mm x 130.6 mm x 107.4 mm	111 mm x 130.6 mm x 107.4 mm	111 mm x 130.6 mm x 107.4 mm
Ambient temperature (operation)	-30°C ... 50°C	-30°C ... 50°C	-30°C ... 50°C	-30°C ... 50°C
Number of power contacts	5 (L1, N, PE, DC+, DC-)	5 (L1, N, PE, DC+, DC-)	5 (L1, N, PE, DC+, DC-)	5 (L1, N, PE, DC+, DC-)
Insertion/withdrawal cycles	> 10,000	> 10,000	> 10,000	> 10,000
Degree of protection (when plugged in)	IP55	IP55	IP55	IP55
Degree of protection (with protective cover)	IP55	IP55	IP55	IP55
Cable data				
Cable length	2 m	2 m	2 m	2 m
Cable structure	2 x 35 mm ² + 1 x 25 mm ² + 2 x 2.5 mm ² + 2 x 0.5 mm ² + 4 x 0.5 mm ²	2 x 35 mm ² + 1 x 25 mm ² + 2 x 6 mm ² + 2 x 0.5 mm ² + 4 x 0.5 mm ²	2 x 70 mm ² + 1 x 25 mm ² + 2 x 2.5 mm ² + 2 x 0.5 mm ² + 4 x 0.5 mm ²	2 x 70 mm ² + 1 x 25 mm ² + 2 x 6 mm ² + 2 x 0.5 mm ² + 4 x 0.5 mm ²
Locking actuator data				
Mechanical emergency release	included	included	included	included
Lock recognition	included	included	included	included
	Ordering data		Ordering data	
Description	Order No.	Pcs./Pkt.	Order No.	Pcs./Pkt.
	20 A AC		32 A AC	
Vehicle inlet for charging with alternating current (AC) and direct current (DC), for installation in electric vehicles (EV)	1624154	1	1627896	1
	1018770	1	1627098	1

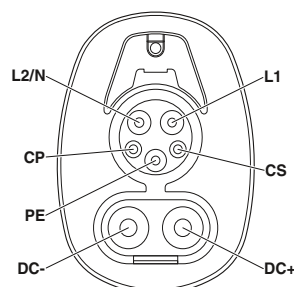

Vehicle inlet pin assignment

GB/T

- Vehicle inlets for charging with direct current (DC)
- Chinese standard (GB/T)
- For installation in electric vehicles
- Additional cable lengths available on request

Notes:
 These products are exclusively developed, manufactured, and distributed by PHOENIX CONTACT electromobility GmbH. Interested? Do you have any questions? Please contact our Sales Team at emobility@phoenixcontact.com or by phone on +49 5235 3-43890.



125 A DC



250 A DC

Rated voltage	1000 V
Rated current	125 A DC
Standards	GB/T 20234.1-2015, GB/T 20234.3-2015
Charging mode	Mode 4
Dimensions (H x W x D)	90 mm x 90 mm x 114.1 mm
Ambient temperature (operation)	-30°C ... 50°C
Number of power contacts	3 (DC+, DC-, PE)
Insertion/withdrawal cycles	> 10,000
Degree of protection (when plugged in)	IP55
Degree of protection (with protective cover)	IP55
Cable data	
Cable length	2 m
Cable structure	2 x 35 mm ² + 1 x 25 mm ² + 2 x 2.5 mm ² + 2 x 0.5 mm ² + 4 x 0.5 mm ²

Technical data

Rated voltage	1000 V
Rated current	250 A DC
Standards	GB/T 20234.1-2015, GB/T 20234.3-2015
Charging mode	Mode 4
Dimensions (H x W x D)	90 mm x 90 mm x 114.1 mm
Ambient temperature (operation)	-30°C ... 50°C
Number of power contacts	3 (DC+, DC-, PE)
Insertion/withdrawal cycles	> 10,000
Degree of protection (when plugged in)	IP55
Degree of protection (with protective cover)	IP55
Cable data	
Cable length	2 m
Cable structure	2 x 70 mm ² + 1 x 25 mm ² + 2 x 2.5 mm ² + 2 x 0.5 mm ² + 4 x 0.5 mm ²

Technical data

Rated voltage	1000 V
Rated current	250 A DC
Standards	GB/T 20234.1-2015, GB/T 20234.3-2015
Charging mode	Mode 4
Dimensions (H x W x D)	90 mm x 90 mm x 114.1 mm
Ambient temperature (operation)	-30°C ... 50°C
Number of power contacts	3 (DC+, DC-, PE)
Insertion/withdrawal cycles	> 10,000
Degree of protection (when plugged in)	IP55
Degree of protection (with protective cover)	IP55
Cable data	
Cable length	2 m
Cable structure	2 x 70 mm ² + 1 x 25 mm ² + 2 x 2.5 mm ² + 2 x 0.5 mm ² + 4 x 0.5 mm ²

Ordering data	
Description	
Vehicle inlet for charging with direct current (DC), for installation in electric vehicles (EV)	
	1627493

Order No.	Pcs./Pkt.
	1

Ordering data	
Order No.	Pcs./Pkt.
	1

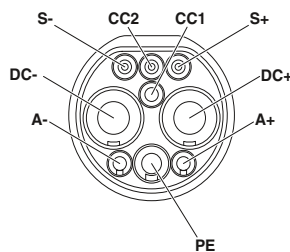

Vehicle inlet pin assignment

Charging controllers

Safe and reliable vehicle charging: you can operate any charging station with our flexible charging controllers – from a single domestic AC wall box, right through to HPC charging station facilities on highways.

These devices monitor and control the electric vehicle charging process in accordance with internationally applicable norms and standards, such as IEC, GB/T, and SAE.

Thanks to our wide range of products, you can realize a vast array of infrastructure concepts tailored to your individual requirements.

 Your web code: [#0501](#)

DC charging controllers	56
AC charging controllers	58
Residual current monitoring	66

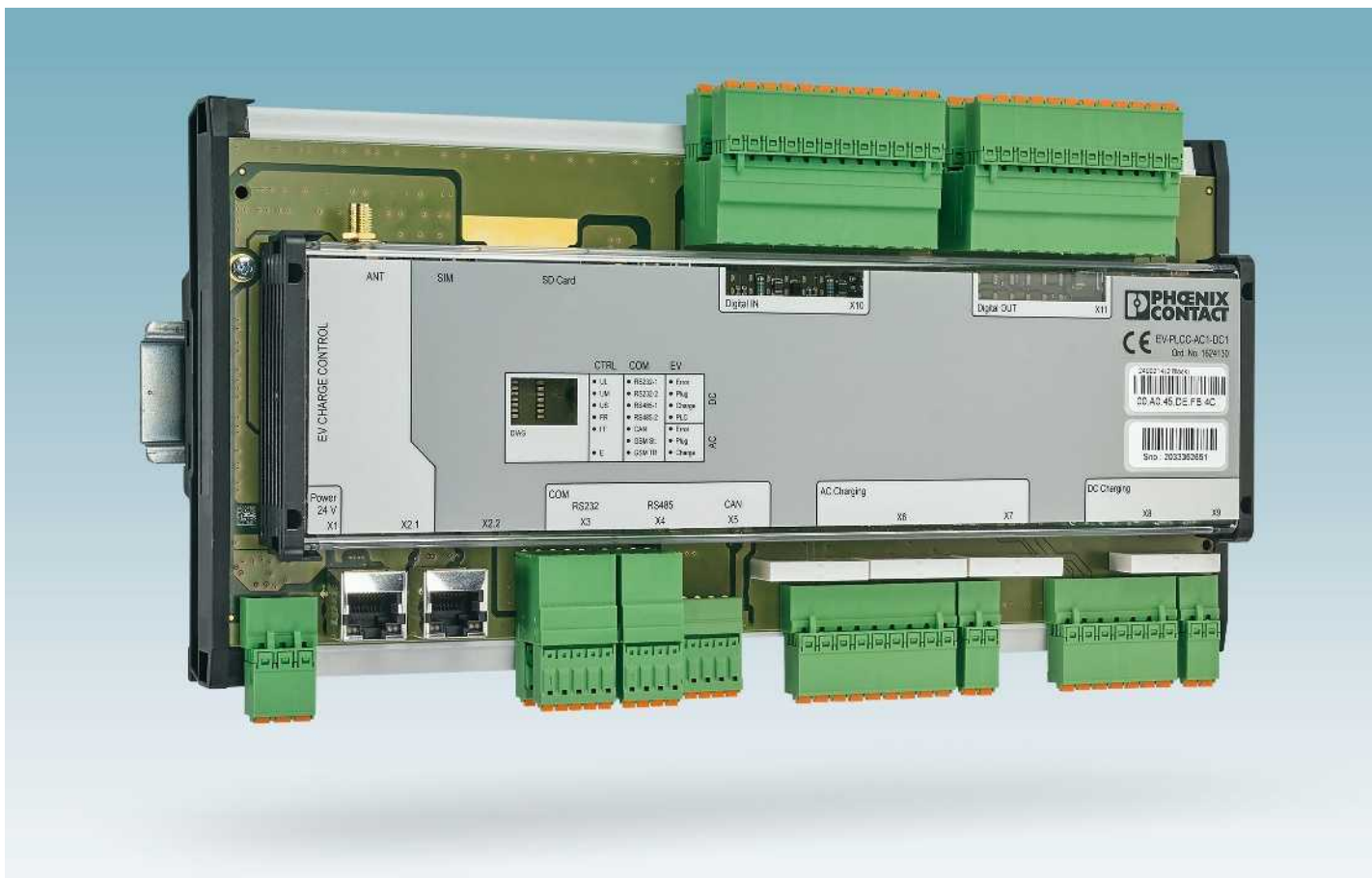

The solution for state-of-the-art fast charging stations

Our freely programmable EVCC Professional DC charging controller is the powerful control solution for your state-of-the-art fast charging station.

It supports both fast DC charging and conventional AC charging, and at the same time takes care of all control and communication tasks, including visualization on the operator panel.

Wide range of possible applications, thanks to free programmability

The EV Charge Control Professional charging controller can be programmed for your individual charging application in accordance with IEC 61131. This makes it a versatile charging controller for the widest possible range of applications.

Furthermore, you can reduce the engineering work required with the ready-made PC Worx function blocks for vehicle communication in accordance with DIN SPEC 70121.

Your advantages

- Two independent charging points (AC and DC) with just one controller
- Highly flexible, thanks to the free programmability in accordance with IEC 61131
- Easy to program, thanks to ready-made function blocks for vehicle communication in accordance with DIN SPEC 70121
- Easy system integration, thanks to comprehensive interfaces
- Convenient remote access via integrated mobile network modem

i Your web code: #1024

For public and commercial applications

- DC charging in accordance with DIN SPEC 70121
- AC charging in accordance with IEC 61851-1, Mode 3
- Serial interfaces: CAN, RS232, RS485
- Ethernet interface
- 3G mobile network interface

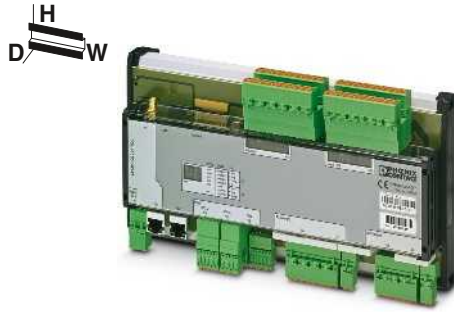

EV Charge Control Professional, freely programmable



Program and configuration memory for DC charging controller with license for the electromobility function blocks

Technical data		Technical data	
Technical data		Technical data	
Standards		IEC 61851-1 / IEC 61851-23 / IEC 61851-1, Annex A+B	
Charging mode		Mode 4 Mode 3, Case B + C	
Number of charging points		2	
IEC 61131 runtime system			
Program memory		1 MB (86 K instructions (IL))	
Mass storage		1 MB	
Retentive mass storage		48 KB (NVRAM)	
Configuration memory		min. 4 MB (depending on storage media)	
Programming tool		PC WORX	
Data interfaces			
Interface		RS-485 2-wire	
Interface		Number of interfaces 2	
Interface		RS-232 interface	
Interface		Number of interfaces 2	
Interface		Ethernet	
Interface		Number of interfaces 2	
Interface		CAN bus	
Interface		Number of interfaces 1	
Wireless interface			
Frequency		850 MHz (0.25 W (UMTS)) / 1900 MHz (0.25 W (UMTS)) / 2100 MHz (0.25 W (UMTS))	
SIM Interface		1.8 V and 3 V SIM card	
GPRS		Class 12, Class B	
EDGE		Multislot Class 10	
UMTS		HSPA 3GPP R6	
Digital inputs/outputs			
Number inputs		16	
Number outputs		16	
Supply voltage U_M		24 V DC -15% / +20% (in accordance with EN 61131-2)	
Output voltage		24 V DC	
Maximum output current per channel		500 mA	
Switching outputs			
Relay output		DC charging enabled	
Maximum switching voltage		30 V (external supply)	
Maximum switching current		6 A (external supply)	
Relay output		AC charging enabled	
Maximum switching voltage		30 V (external supply)	
Maximum switching current		6 A (external supply)	
Relay output		AC charging locking system	
Maximum output voltage		12 V DC (internal supply)	
Maximum output current		max. 2 A	
Behavior in the event of voltage drop		Automatic unlocking	
Device supply			
Supply voltage		24 V DC	
General data			
Degree of protection		IP20	
Ambient temperature (operation)		-25°C ... 55°C	
Mounting position		horizontal	
Dimensions W/H/D		285 / 158 / 70 mm	
Compliance/approvals			
Compliance		CE-compliant	

Ordering data				Ordering data			
Description	Type	Order No.	Pcs./Pkt.	Type	Order No.	Pcs./Pkt.	
Programmable DC charging controller	EV-PLCC-AC1-DC1	1624130	1				
Program/configuration memory				SD-FLASH-2GB-EV-EMOB	1624092	1	



Electric charging – Worldwide

With our AC charging controllers, you can charge electric vehicles in accordance with international standards. The portfolio addresses the entire spectrum of AC charging stations:

- Our EVCC Basic AC charging controller is ideal for simple, private charging points such as wall boxes in garages and carports
- The EVCC Advanced and EVCC Advanced Plus controllers are the perfect solution for public and commercial AC applications with several charging points, load and energy management, remote access, and billing

From a single charging point through to networked charging infrastructure

Phoenix Contact charging controllers can be operated both autonomously and in networks. Status data is acquired via the integrated communication interfaces, and controlled intervention in the charging process is supported.

Here, we focus on the use of standardized communication interfaces and protocols, therefore providing easy connection options to a variety of automation systems.

Your advantages

- Standard-compliant AC charging in accordance with IEC 61851-1, SAE J1772, and GB/T 20234
- High flexibility, thanks to extensive configuration options
- Easy realization of intelligent charging infrastructures with charging management
- Easy integration into management systems via standardized communication interfaces

i Your web code: [#2102](#)



EV Charge Control Basic for private applications

This product is a compact, cost-effective controller solution specifically for simple charging points. The charging controller is available as a DIN rail device and as a coated PCB version for harsh environments. An additional version with Push-in connection technology is available for compact, quick installation in charging station housings.

EV Charge Control Advanced for commercial applications

This charging controller integrates all the necessary control functions for commercial charging points, and features comprehensive configuration options via DIP switch. Furthermore, it supports load and energy management on company premises and in parking lots, thanks to its Ethernet interface. Energy meters can also be integrated via the RS-485 interface.

EV Charge Control Advanced Plus for public applications

This charging controller combines all relevant control, communication, and monitoring functions in one compact housing. Along with Ethernet and RS-485 interfaces, the controller features DC residual current monitoring, an automatic connector release mechanism in the event of voltage failure, convenient user authorization via RFID, and convenient configuration via web interface.

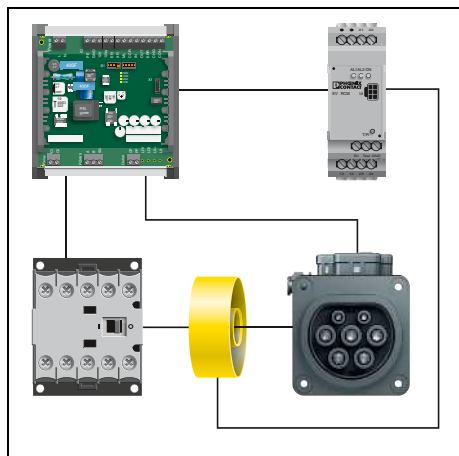

Application example: single charging point

The Basic AC charging controller can be used to install simple charging stations with just a few components quickly – whether at home or in a commercial environment. Thanks to the optional connection of RCM modules for residual current detection, you can increase the voltage protection level of the charging station in accordance with normative specifications. Maximum system availability is thereby achieved.

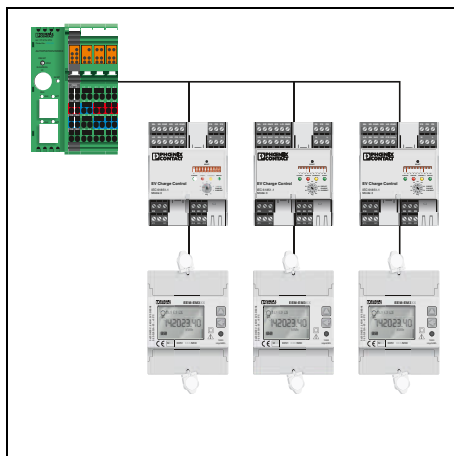

Application example: networked charging points

The configurable RS-485 interface can be used to connect various energy meters to the Advanced AC charging controller, making it possible to record the charging point performance data. Using the integrated Ethernet interface, you can configure the charging controller and establish an intelligent connection to higher-level control systems.

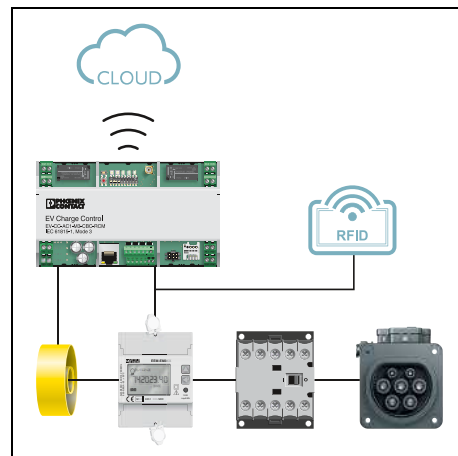

Application example: charging point with back-end integration

As an option, the Advanced Plus charging controller is available with an integrated 3G modem and OCPP interface. This allows you to link a charging station to cloud-based billing systems via mobile network and OCPP. A MID energy meter can be integrated into the application for precise billing. This makes the controller an ideal solution for public applications.

Charging controllers

AC charging controllers

For public and commercial applications

- For charging cases B and C
- AC charging in accordance with IEC 61851-1
- Ethernet interface for charging and energy management
- RS-485 interface for connection to power meters
- Optional 3G mobile network interface (OCPP 1.6j), DC residual current detection, connector release in the event of mains failure



EV Charge Control Advanced Plus 3G
For charging cases B and C



EV Charge Control Advanced Plus
For charging cases B and C

		Technical data	Technical data
Technical data			
Standards		IEC 61851-1	IEC 61851-1
Charging mode		Mode 3, Case B + C	Mode 3, Case B + C
Number of charging points		1	1
Data interfaces			
Interface		RS-485 2-wire	RS-485 2-wire
	Number of interfaces	1	1
	Number of supported devices	2	2
	Protocol	Modbus/RTU (master)	Modbus/RTU (master)
Interface		Ethernet	Ethernet
	Number of interfaces	1	1
	Protocol	Modbus/TCP	Modbus/TCP
Wireless interface			
Frequency		900 MHz (HSPA) / 2100 MHz (HSPA) / 850 MHz (GSM/GPRS/EDGE) / 900 MHz (GSM/GPRS/EDGE) / 1800 MHz (GSM/GPRS/EDGE) / 1900 MHz (GSM/GPRS/EDGE)	-
SIM Interface		Micro-SIM	-
Protocols supported		OCPP 1.6j	-
Residual current measuring range			
Residual current $I_{\Delta n}$		30 mA (AC) 6 mA (DC)	30 mA (AC) 6 mA (DC)
Tripping time for $I_{\Delta n}$		< 180 ms	< 180 ms
Rated current I_n		32 A (three-phase, 4x6 mm ²) 48 A (single-phase)	32 A (three-phase, 4x6 mm ²) 48 A (single-phase)
Measuring current transducer			
Diameter of measuring coil		15 mm	15 mm
Digital inputs/outputs			
Number inputs		5	5
	Nominal input voltage U_N	12 V	12 V
Number outputs		4 digital outputs	4 digital outputs
	Minimum output voltage	4 V	4 V
	Maximum output voltage	30 V	30 V
	Maximum output current	0.2 A (total current for all outputs; internally supplied)	0.2 A (total current for all outputs; internally supplied)
	Maximum output current per channel	0.6 A (per output; externally supplied)	0.6 A (per output; externally supplied)
Switching outputs			
Relay output		Relay output C _{1,2} 250 V AC (external supply)	Relay output C _{1,2} 250 V AC (external supply)
	Maximum switching voltage	16 A	16 A
Relay output		Motor switching output	Motor switching output
	Maximum switching voltage	12 V (internal supply)	12 V (internal supply)
	Maximum switching current	1 A (maximum)	1 A (maximum)
Locking release in the event of mains failure		Integrated release function of the locking actuator for disconnection of infrastructure charging plug and infrastructure socket outlet	Integrated release function of the locking actuator for disconnection of infrastructure charging plug and infrastructure socket outlet
Device supply			
Supply voltage		230 V	230 V
General data			
Degree of protection		IP20	IP20
Ambient temperature (operation)		-25°C ... 60°C	-25°C ... 60°C
Mounting position		any	any
Dimensions W/H/D		162 / 90 / 61 mm	162 / 90 / 61 mm
Compliance/approvals			
Compliance		CE-compliant	CE-compliant

		Ordering data			Ordering data		
Description	Type	Order No.	Pcs./Pkt.	Type	Order No.	Pcs./Pkt.	
AC charging controller, DIN rail housing	EV-CC-AC1-M3-CBC-RCM-ETH-3G	1018702	1	EV-CC-AC1-M3-CBC-RCM-ETH	1018701	1	
Locking release module							



**EV Charge Control Advanced
For charging cases B and C**



**Module for release in the event of
a mains failure in charging case B
For EV Charge Control Advanced**

Technical data
IEC 61851-1 Mode 3, Case B + C 1
RS-485 2-wire 1 1
Modbus/RTU (slave) Ethernet 1 Modbus/TCP
-
-
-
-
-
-
4 24 V 4 digital outputs 12 V 30 V 0.2 A (total current for all outputs; internally supplied) 0.6 A (per output; externally supplied)
Relay output C _{1,2} 250 V AC (external supply) 6 A Relay output R _{1,3} and R _{2,4} 30 V AC/DC (external supply) 6 A With EM-EV-CLR-12V locking release module (Order No. 2903246) as an option
230 V
IP20 -25°C ... 60°C any 71.6 / 90 / 61 mm
CE-compliant

Technical data
IEC 61851-1 / EN 61000-6-2 / EN 61000-6-3 Mode 3 1
-
-
-
-
-
-
-
-
1 12 V - - - -
Relay output OUT+/- Approx. 11.5 V (operating/capacitor voltage minus the diode voltage of ~ 0.5 V) 4 A - - Integrated release function of the locking actuator for disconnection of infrastructure charging plug and infrastructure socket outlet
12 V DC
IP20 -25°C ... 60°C any 35.6 / 90 / 61 mm
CE-compliant

Ordering data		
Type	Order No.	Pcs./Pkt.
EM-CP-PP-ETH	2902802	1

Ordering data		
Type	Order No.	Pcs./Pkt.
EM-EV-CLR-12V	2903246	1

Charging controllers

AC charging controllers

For private applications, in a DIN rail housing

- For charging cases B and C
- AC charging in accordance with IEC 61851-1
- Comprehensive configuration options
- Adjustable current
- RS-485 interface
- Push-in or screw connection

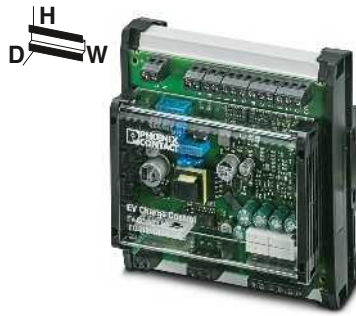

**EV Charge Control Basic
For charging case B
With screw connection**

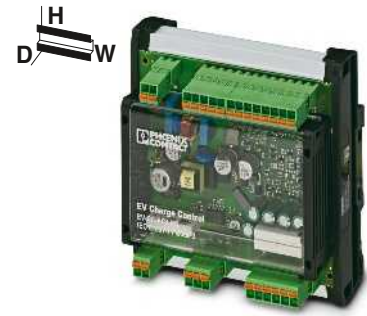

**EV Charge Control Basic
For charging case B
With Push-in connection**

			Technical data			Technical data		
Technical data								
Standards			IEC 61851-1 / GB/T 18487.1-2015 / SAE J1772			IEC 61851-1 / GB/T 18487.1-2015 / SAE J1772		
Charging mode			Mode 3, Case B + C			Mode 3, Case B + C		
Number of charging points			1			1		
Data interfaces								
Interface			RS-485 2-wire			RS-485 2-wire		
		Number of interfaces	1					1
		Protocol	Modbus/RTU (slave)					Modbus/RTU (slave)
Digital inputs/outputs								
Number inputs			5			5		
		Nominal input voltage U_N	12 V					12 V
Number outputs			4 digital outputs			4 digital outputs		
		Minimum output voltage	5 V					5 V
		Maximum output voltage	30 V					30 V
		Maximum output current	0.5 A (total current for all outputs; internally supplied)					0.5 A (total current for all outputs; internally supplied)
Switching outputs								
Relay output			Relay output $C_{1,2}$			Relay output $C_{1,2}$		
		Maximum switching voltage	250 V AC (external supply)					250 V AC (external supply)
		Maximum switching current	6 A					6 A
Relay output			Relay output LO+/-			Relay output LO+/-		
		Maximum switching voltage	12 V (internal supply)					12 V (internal supply)
		Maximum switching current	2 A					2 A
Locking release in the event of mains failure			Integrated release function of the locking actuator for disconnection of infrastructure charging plug and infrastructure socket outlet			Integrated release function of the locking actuator for disconnection of infrastructure charging plug and infrastructure socket outlet		
Device supply								
Supply voltage			230 V			230 V		
General data								
Degree of protection			IP20			IP20		
Ambient temperature (operation)			-35°C ... 70°C			-35°C ... 70°C		
Mounting position			any			any		
Dimensions W/H/D			124 / 128 / 64 mm			124 / 128 / 67 mm		
Compliance/approvals								
Compliance			CE-compliant			CE-compliant		
			Ordering data			Ordering data		
Description			Type	Order No.	Pcs./Pkt.	Type	Order No.	Pcs./Pkt.
AC charging controller, DIN rail housing			EV-CC-AC1-M3-CBC-SER-HS	1622452	1	EV-CC-AC1-M3-CBC-SER-HS-MSTB	1081341	1

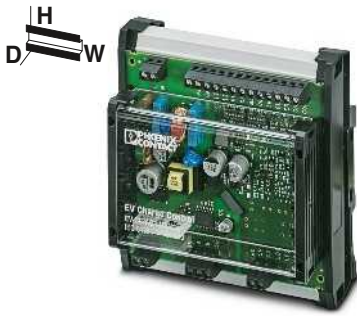

EV Charge Control Basic
For charging case C
With screw connection

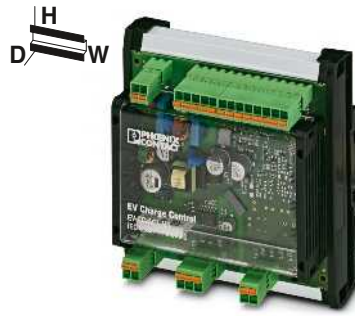

EV Charge Control Basic
For charging case C
With Push-in connection

Technical data
IEC 61851-1 / GB/T 18487.1-2015 / SAE J1772 Mode 3, Case C 1
RS-485 2-wire 1 Modbus/RTU (slave)
5 12 V 4 digital outputs 5 V 30 V 0.5 A (total current for all outputs; internally supplied)
Relay output C _{1,2} 250 V AC (external supply) 6 A - - -
230 V
IP20 -35°C ... 70°C any 124 / 128 / 64 mm
CE-compliant

Ordering data		
Type	Order No.	Pcs./Pkt.
EV-CC-AC1-M3-CC-SER-HS	1622459	1

Technical data
IEC 61851-1 / GB/T 18487.1-2015 / SAE J1772 Mode 3, Case C 1
RS-485 2-wire 1 Modbus/RTU (slave)
5 12 V 4 digital outputs 5 V 30 V 0.5 A (total current for all outputs; internally supplied)
Relay output C _{1,2} 250 V AC (external supply) 6 A - - -
230 V
IP20 -35°C ... 70°C any 124 / 128 / 67 mm
CE-compliant

Ordering data		
Type	Order No.	Pcs./Pkt.
EV-CC-AC1-M3-CC-SER-HS-MSTB	1081335	1

Charging controllers

AC charging controllers

For private applications as a PCB

- For charging cases B and C
- AC charging in accordance with IEC 61851-1
- Comprehensive configuration options
- Adjustable current
- RS-485 interface
- Push-in or screw connection
- With coated PCB as an option

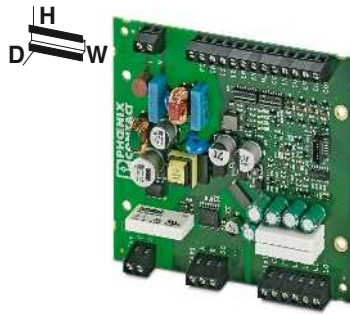

EV Charge Control Basic
For charging case B
With screw connection

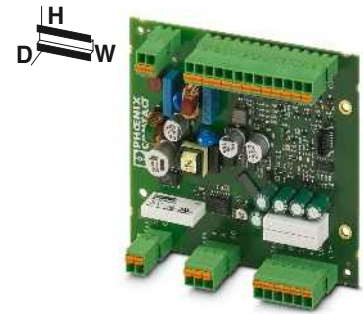

EV Charge Control Basic
For charging case B
With Push-in connection

			Technical data			Technical data		
Technical data								
Standards			IEC 61851-1 / GB/T 18487.1-2015 / SAE J1772			IEC 61851-1 / GB/T 18487.1-2015 / SAE J1772		
Charging mode			Mode 3, Case B + C			Mode 3, Case B + C		
Number of charging points			1			1		
Data interfaces								
Interface			RS-485 2-wire			RS-485 2-wire		
			Number of interfaces			1		
			Protocol			Modbus/RTU (slave)		
Digital inputs/outputs								
Number inputs			5			5		
			Nominal input voltage U_N			12 V		
Number outputs			4 digital outputs			4 digital outputs		
			Minimum output voltage			5 V		
			Maximum output voltage			30 V		
			Maximum output current			0.5 A (total current for all outputs; internally supplied)		
Switching outputs								
Relay output			Relay output $C_{1,2}$			Relay output $C_{1,2}$		
			Maximum switching voltage			250 V AC (external supply)		
			Maximum switching current			6 A		
Relay output			Relay output LO+/-			Relay output LO+/-		
			Maximum switching voltage			12 V (internal supply)		
			Maximum switching current			2 A		
Locking release in the event of mains failure			Integrated release function of the locking actuator for disconnection of infrastructure charging plug and infrastructure socket outlet			Integrated release function of the locking actuator for disconnection of infrastructure charging plug and infrastructure socket outlet		
Device supply								
Supply voltage			230 V			230 V		
General data								
Degree of protection			IP00			IP00		
Ambient temperature (operation)			-35°C ... 70°C			-35°C ... 70°C		
Mounting position			any			any		
Dimensions W/H/D			120 / 108 / 20 mm			120 / 108 / 34 mm		
Compliance/approvals								
Compliance			CE-compliant			CE-compliant		
			Ordering data			Ordering data		
Description			Type			Type		
AC charging controller			Order No.			Order No.		
Uncoated PCB			Pcs./Pkt.			Pcs./Pkt.		
Coated PCB, Pcs./Pkt. 1			EV-CC-AC1-M3-CBC-SER-PCB			EV-CC-AC1-M3-CBC-SER-PCB-MSTB		
Coated PCB, Pcs./Pkt. 25			EV-CC-AC1-M3-CBC-SER-PCB-XC			1627353		
			EV-CC-AC1-M3-CBC-SER-PCB-XC-25			1		
			1622453			1		
			1628393			1		
			1627743			25		

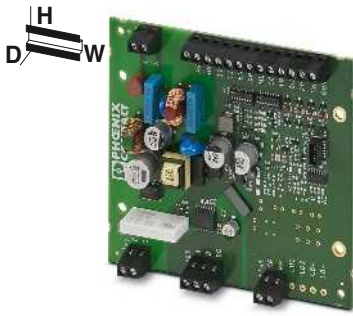

EV Charge Control Basic
For charging case C
With screw connection

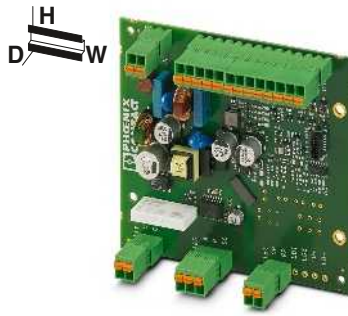

EV Charge Control Basic
For charging case C
With Push-in connection

Technical data
IEC 61851-1 / GB/T 18487.1-2015 / SAE J1772 Mode 3, Case C 1
RS-485 2-wire 1 Modbus/RTU (slave)
5 12 V 4 digital outputs 5 V 30 V 0.5 A (total current for all outputs; internally supplied)
Relay output C _{1,2} 250 V AC (external supply) 6 A - - -
230 V
IP00 -35°C ... 70°C any 120 / 108 / 20 mm
CE-compliant

Ordering data		
Type	Order No.	Pcs./Pkt.
EV-CC-AC1-M3-CC-SER-PCB	1622460	1
EV-CC-AC1-M3-CC-SER-PCB-XC	1628394	1
EV-CC-AC1-M3-CC-SER-PCB-XC-25X	1627742	25

Technical data
IEC 61851-1 / GB/T 18487.1-2015 / SAE J1772 Mode 3, Case C 1
RS-485 2-wire 1 Modbus/RTU (slave)
5 12 V 4 digital outputs 5 V 30 V 0.5 A (total current for all outputs; internally supplied)
Relay output C _{1,2} 250 V AC (external supply) 6 A - - -
230 V
IP00 -35°C ... 70°C any 120 / 108 / 34 mm
CE-compliant

Ordering data		
Type	Order No.	Pcs./Pkt.
EV-CC-AC1-M3-CC-SER-PCB-MSTB	1627367	1



Universal residual current monitoring

With a residual current monitoring module from the EV-RCM series, AC and DC residual currents can be detected with a measurement sensor in accordance with the requirements of IEC 62752.

In combination with a type A residual current device, the module saves you from having to use an expensive type B residual current device because it interrupts the charging process in the event of an error.

An optional connection to a charging controller from Phoenix Contact allows for convenient status monitoring as well as automatic resetting as soon as the residual current is no longer present. As a result, you avoid costly maintenance and ensure that the charging point is immediately available again for further charging processes.

Compatible charging controllers

Benefit from the status monitoring and automatic reset functions of the RCM modules by installing the EV Charge Control Basic or EV Charge Control Advanced charging controller from Phoenix Contact.

In this combination, they achieve the required protection against electric shock during the electric vehicle process in accordance with IEC 61851-1 and DIN VDE 0100-722.

Your advantages

- Universal residual current detection with a measuring transducer
- Use and continued operation of type A residual current circuit breaker possible
- High system availability, thanks to continuous residual current monitoring
- Status monitoring in conjunction with Phoenix Contact charging controllers
- Automatic reset via Phoenix Contact charging controllers in the event of errors

i Your web code: #2103

Residual current monitoring modules

- Universal residual current monitoring for AC and DC residual current detection
- Response values DC 6 mA and AC 30 mA
- Protection of higher-level safety equipment, such as type A residual current circuit breakers, against DC residual currents

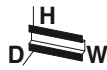

Single-channel module for one charging point



Two-channel module for two charging points

	Technical data	Technical data				
Input						
Measuring transducer input	Plug-in; front	Plug-in; front				
Switching outputs						
Alarm relay	Alarm relay 1 $I_{\Delta n}$: DC residual currents Alarm relay 2 $I_{\Delta n}$: AC residual currents	Alarm relay 1 $I_{\Delta n}$: AC and DC residual currents Alarm relay 2 $I_{\Delta n}$: AC and DC residual currents				
Maximum switching voltage	250 V	250 V				
Maximum switching current	5 A (1 N/O contact each)	5 A (1 N/O contact each)				
Method of operation	Closed-circuit current	Closed-circuit current				
Residual current measuring range						
Rated frequency	≤ 2000 Hz	≤ 2000 Hz				
Number of channels	1	2				
Measuring range	± 300 mA (peak)	± 300 mA (peak)				
Current measuring range	50 A (45 Hz ... 50 Hz)	50 A (45 Hz ... 50 Hz)				
Residual current $I_{\Delta n1}$	30 mA	30 mA				
Residual current $I_{\Delta n2}$	6 mA	6 mA				
Load current	32 A	32 A				
Response time at 1 x $I_{\Delta n}$	< 180 ms	< 180 ms				
Response time at 2 x $I_{\Delta n}$	< 70 ms	< 70 ms				
Response time at 5 x $I_{\Delta n}$	< 20 ms	< 20 ms				
Response time at I_N	< 500 ms	< 500 ms				
Reload function	3 switch-on attempts at intervals of 15 min	3 switch-on attempts at intervals of 15 min				
Measuring current transducer						
Cable feed-through diameter	15 mm	15 mm				
Supply	via RCM module	via RCM module				
Connection method	Connector	Connector				
Signal interfaces						
Number of interfaces	1 (measuring transducer)	2 (measuring transducer)				
Device supply						
Supply voltage range	100 V AC ... 240 V AC (nominal voltage range)	100 V AC ... 240 V AC (nominal voltage range)				
Nominal power consumption	< 0.5 W (no-load)	< 0.5 W (no-load)				
Frequency range	45 Hz ... 60 Hz	45 Hz ... 60 Hz				
General data						
Degree of protection	IP20 (terminal blocks)	IP20 (terminal blocks)				
Operating elements	Test/reset button; 2 status LEDs	Test/reset button; 2 status LEDs				
Ambient temperature (operation)	-25°C ... 80°C	-25°C ... 80°C				
Dimensions W/H/D	36 / 90 / 70.5 mm	36 / 90 / 70.5 mm				
Compliance/approvals						
Compliance	CE-compliant	CE-compliant				
	Ordering data	Ordering data				
Description	Type	Order No.	Pcs./Pkt.	Type	Order No.	Pcs./Pkt.
RCM module	EV-RCM-C1-AC30-DC6	1622450	1	EV-RCM-C2-AC30-DC6	1622451	1



Build it yourself – E-Mobility AC charging set
HOME-Set with Type 2 socket outlet

PHOENIX CONTACT
INSPIRING INNOVATIONS

1750014-0001-0001
1750014-0001-0001

Charging technology sets

Our AC charging technology sets are the perfect introduction to the world of charging technology for electrical engineers. The sets include a plug-and-play configuration of all the components an engineer would need to set up private or commercial AC charging stations simply and single-handedly.

A verified wiring diagram and corresponding assembly instructions with recommendations for further required components are available to download. This means that no additional development effort is required.

i Your web code: #2071

Sets for private applications	70
Sets for commercial applications	71

Charging technology sets

Sets for private applications

- Consisting of components for charging stations with one charging point
- Stand-alone structure in accordance with a wiring diagram
- Assembly instructions for a charging station with recommendations for further components required (charging contactor, safety equipment)



For one charging point with a type 2 AC charging cable



For one charging point with a type 2 AC infrastructure socket outlet

Number of charging points
Type of charging point

Standards
Charging standard
Charging mode
Charging power
Supply voltage
Connected current
Type of charging current
Charging controller
Locking release in the event of mains failure

Residual current monitoring module
Real power measurement module
Wiring diagram
Cable length
Cable length actuator
Cable type
Cable color

Technical data

1
AC charging cable with vehicle charging connector, open cable end, protective cap, holder (park position)

IEC 62196-2 / IEC 61851-1
Type 2
Mode 3, Case C
3.7 kW
230 V AC
16 A
AC single-phase
Basic AC charging controller, preconfigured
-

1-channel RCM
-
Including download of example circuit diagram
5.00 m
-
straight
black

Technical data

1
AC infrastructure socket outlet, 12 V locking actuator, self-closing IP54 protective cover

IEC 62196-2 / IEC 61851-1
Type 2
Mode 3, Case B
11 kW
400 V AC
16 A
AC 3-phase
Basic AC charging controller, preconfigured
Integrated release function of the locking actuator for disconnection of infrastructure charging plug and infrastructure socket outlet

1-channel RCM
-
Including download of example circuit diagram
0.70 m
0.50 m
Single wires
-

Ordering data

Description	Type	Order No.	Pcs./Pkt.
Home charging technology set			
With AC charging cable	EV-SET-T2AC-BAS-RCM1-20AC5MES	1628077	1
With AC infrastructure socket outlet			

Ordering data

Description	Type	Order No.	Pcs./Pkt.
Home charging technology set			
With AC infrastructure socket outlet	EV-SET-T2AC-BAS-RCM1-20ASE12	1628080	1

- Consisting of components for charging stations with two charging points
- Stand-alone structure in accordance with a wiring diagram
- Assembly instructions for a charging station with recommendations for further components required (charging contactor, safety equipment)



For two charging points with a type 2 AC charging cable



For two charging points with a type 2 AC infrastructure socket outlet

Number of charging points
Type of charging point

Standards
Charging standard
Charging mode
Charging power
Supply voltage
Connected current
Type of charging current
Charging controller
Locking release in the event of mains failure

Residual current monitoring module
Real power measurement module
Wiring diagram
Cable length
Cable length actuator
Cable type
Cable color

Technical data

2
AC charging cable with vehicle charging connector, open cable ends, protective caps, holders (park positions)

IEC 62196-2 / IEC 61851-1
Type 2
Mode 3, Case C
22 kW
400 V AC
32 A
AC 3-phase
Advanced AC charging controller
-

2-channel RCM
-
Including download of example circuit diagram
5.00 m
-
straight
black

Ordering data

Description	Ordering data		
	Type	Order No.	Pcs./Pkt.
TWIN charging technology set With AC charging cable With AC infrastructure socket outlet	EV-SET-T2AC-ADV-RCM2-32AC5MES	1628081	1

Technical data

2
AC infrastructure socket outlets, 12 V locking actuators, self-closing IP54 protective covers

IEC 62196-2 / IEC 61851-1
Type 2
Mode 3, Case B
22 kW
400 V AC
32 A
AC 3-phase
Advanced AC charging controller
Separate module with release function of the locking actuator for disconnection of infrastructure charging plug and infrastructure socket outlet
2-channel RCM
Energy meters
Including download of example circuit diagram
0.70 m
0.50 m
Single wires
-

Ordering data

Description	Ordering data		
	Type	Order No.	Pcs./Pkt.
TWIN charging technology set With AC infrastructure socket outlet	EV-SET-T2AC-ADV-RCM2-32ASE12	1628082	1

PHOENIX CONTACT

EV Charging Suite
Charging park management

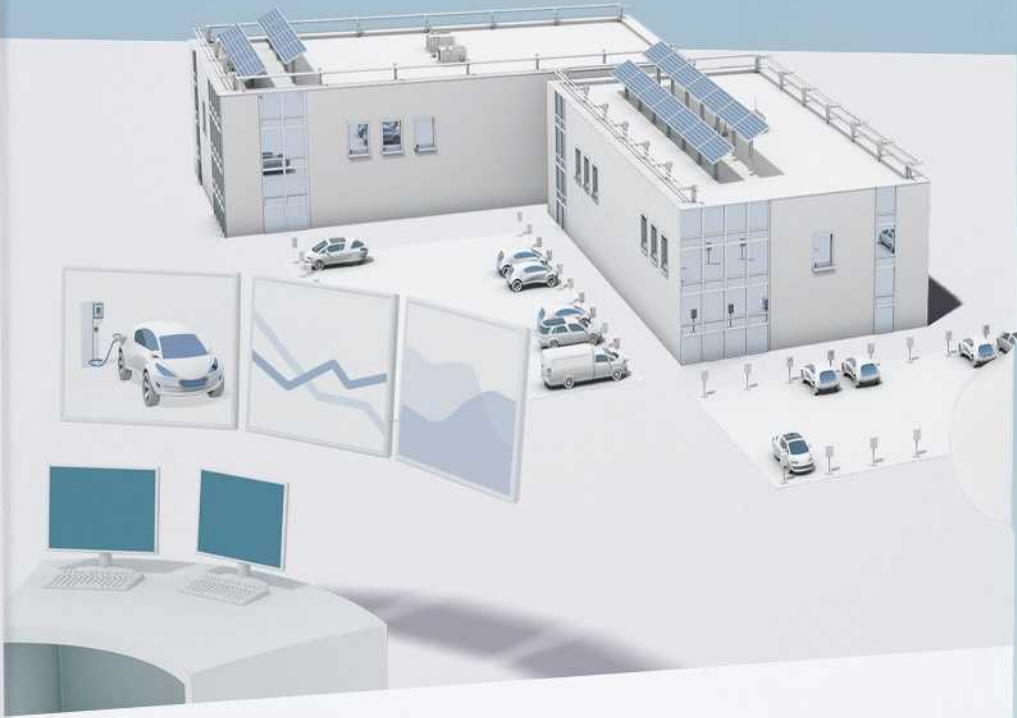

EV Charging Suite

Charging park management



Charging park management software

The brain behind your charging application: you can manage your entire charging infrastructure with our powerful software, and also increase availability. You can automate individual charging points or entire charging parks including authorization, user guides, load management, and billing.

With the EV Charging Suite, you receive a software package that already contains all of the functions for charging park management.

Should you have special requirements, our programmers will be happy to create an individual software solution for your charging application.

Software suite

74

i Your web code: [#2020](#)



Intelligent charging park management

The EV Charging Suite forms the interface between the driver, charging park, grid operator, and back-end provider. It combines all of the functions you need to operate a charging park in a single software package.

In addition to load management, it also makes it easy to manage charging points and users, implement various authorization methods, and utilize a consumption-based billing system via the back-end provider.

Scalable license model

We offer graduated basic licenses for 10, 30, and 50 charging points to match the size of your charging park. You therefore only have to pay for what you actually need.

The licenses are valid for a lifetime and include all updates for the EV Charging Suite that we make available for download.

Should you extend your charging park to the extent that the basic license purchase is no longer sufficient, you can purchase a cost-effective upgrade license.

Your advantages

- Intelligent load management ensures optimum distribution of the connected load and prevents overloads
- Easy commissioning, configuration, and monitoring of your charging park via web interface
- Future-proof and scalable, thanks to the easy addition and management of charging points
- Reliable logging of all charging procedures via OCPP for real-time visualization and precise billing
- Convenient integration into higher-level building and energy management systems
- Intuitive graphical user guidance for your customers

i Your web code: **#2020**

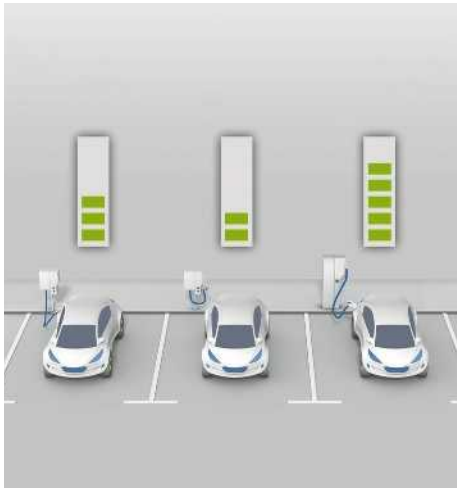

Load management for greater availability

The integrated load management system ensures optimum distribution of the available connected load to the charging points. This prevents the main fuse from being tripped by an overload, ensuring the availability of your charging park. Furthermore, this allows you to avoid significant surcharges that can arise when you exceed the contractually agreed maximum power.



Convenient configuration via browser

You can use a web browser to commission, configure, and monitor your charging park. You can add new charging points and users, configure the load distribution in accordance with your requirements, and call up diagnostic and status information for each charging point. The logged data is clearly visualized and can be exported for external evaluation.



User guide step 1: Authorization

Your charging park customers are quickly and clearly guided through the vehicle charging process with the aid of our self-explanatory touch screen. The customer first obtains authorization at the charging point or terminal, e.g., using an RFID card.



User guide step 2: Selecting a charging point

The customer selects one of the available charging points.



User guide step 3: Connecting the vehicle

The customer is asked to connect their vehicle with a charging cable.

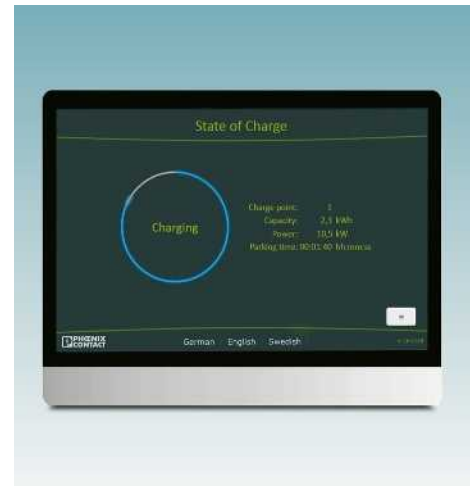

User guide step 4: Starting the charging process

During the charging process, the screen provides information on key values, such as the current charging power.

- Administration of users and charging points
- Graphical user guidance
- User authorization, e.g. via RFID
- Charging and load management
- Billing via OCPP
- Integration into building and energy management systems



License for up to 10 charging points

Technical data			
IPC hardware requirement	Min. 64 GB Min. 4 GB Min. Atom™ Quadcore 1.91 GHz When used on site with operator panel: min. 8" touch panel, 800 x 480 pixels (WVGA)		
Hard disk			
RAM			
CPU			
Display			
Interfaces	2x Ethernet (10/100/1000 Mbps), RJ45 / min. 1x USB 2.0 / Depending on application: min. 1x COM RS-485		
IPC software requirements	WIN 10 IOT ENT LTSB 2016 x64		
Operating system	German English		
Languages supported	Google Chrome Mozilla Firefox Internet Explorer		
Supported web browsers	EVCC Advanced AC charging controller (Order No. 2902802)		
Supported charging controllers			
Functions			
Basic functions	Load and charging management Authentication via RFID or via backend Backend coupling		
Expanded functionality	Dynamic load management User prioritization Integration into energy management systems		
Supported back-end protocols	OCPP		
Ordering data			
Description	Type	Order No.	Pcs./Pkt.
License for charging park management software For up to 10 licenses For up to 30 licenses For up to 50 licenses	EV-CC-S-SUITE-CP10	1086929	1
Upgrade license for charging park management software For up to 30 licenses For up to 50 licenses			



License for up to 30 charging points



License for up to 50 charging points

Technical data

Min. 64 GB
 Min. 4 GB
 Min. Atom™ Quadcore 1.91 GHz
 When used on site with operator panel: min. 8" touch panel, 800 x 480 pixels (WVGA)
 2x Ethernet (10/100/1000 Mbps), RJ45 /
 min. 1x USB 2.0 /
 Depending on application: min. 1x COM RS-485

WIN 10 IOT ENT LTSB 2016 x64
 German
 English
 Google Chrome
 Mozilla Firefox
 Internet Explorer
 EVCC Advanced AC charging controller (Order No. [2902802](#))

Load and charging management
 Authentication via RFID or via backend
 Backend coupling
 Dynamic load management
 User prioritization
 Integration into energy management systems
 OCPP

Technical data

Min. 64 GB
 Min. 4 GB
 Min. Atom™ Quadcore 1.91 GHz
 When used on site with operator panel: min. 8" touch panel, 800 x 480 pixels (WVGA)
 2x Ethernet (10/100/1000 Mbps), RJ45 /
 min. 1x USB 2.0 /
 Depending on application: min. 1x COM RS-485

WIN 10 IOT ENT LTSB 2016 x64
 German
 English
 Google Chrome
 Mozilla Firefox
 Internet Explorer
 EVCC Advanced AC charging controller (Order No. [2902802](#))

Load and charging management
 Authentication via RFID or via backend
 Backend coupling
 Dynamic load management
 User prioritization
 Integration into energy management systems
 OCPP

Ordering data

Type	Order No.	Pcs./Pkt.
EV-CC-S-SUITE-CP30	1086921	1
EV-CC-S-SUITE-UPG10-30	1086891	1

Ordering data

Type	Order No.	Pcs./Pkt.
EV-CC-S-SUITE-CP50	1086920	1
EV-CC-S-SUITE-UPG30-50	1086889	1

Quality in quantity

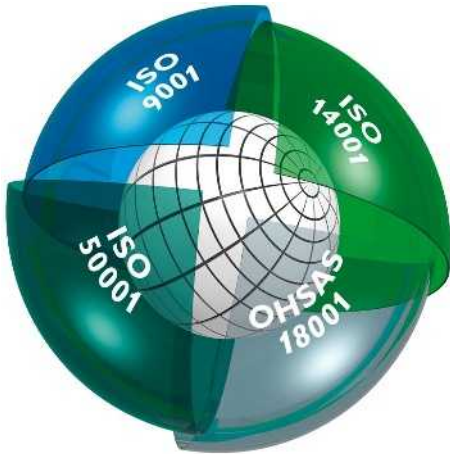

Integrated management system

The objective of the Phoenix Contact integrated management system is to integrate all requirements pertaining to products, processes, and the organization.

Statutory and regulatory requirements, as well as those of international standards and our customers, are met and, in some cases, even exceeded in all phases of the product lifecycle.

The Phoenix Contact management system is monitored by internationally recognized independent bodies each year to ensure that quality, environmental protection, energy efficiency, and occupational safety have been integrated in conformance with the relevant requirements. Certification in accordance with international standards ISO 9001, ISO 14001, ISO 50001, and BS OHSAS 18001 is the result of our corporate philosophy of meeting the needs of our customers, staff, and environment as best as possible. This serves as the basis for innovative products with the familiar high Phoenix Contact quality standard, actively practiced environmental protection through efficient production and products that conserve resources, and responsibility in the field of occupational health and safety. It goes without saying that we integrate all further requirements of standards, international approvals or special customer requirements into our company processes.

The result of this system is a building block for the success of the Phoenix Contact Group as well as its products and services.

CE marking

CE marking was introduced as an important instrument for the free movement of goods and services within the single European market. By applying the mark to a product, the manufacturer confirms its compliance with all EU directives applicable to this product. The EU directives describe the product characteristics with regard to device safety and the avoidance of risks. They have been incorporated in national legislation.

Compliance with the requirements is a **condition for placing the product on the market within the EU.**

Where applicable, our products currently fall within the scope of the following directives in particular:

- 2014/35/EU
Electrical equipment designed for use within certain voltage limits (Low Voltage Directive)
- 2014/30/EU
Electromagnetic compatibility (EMC Directive)
- 2014/32/EU
Measuring instruments
- 2006/42/EC
Safety of machinery (Machinery Directive)
- 2014/34/EU
Equipment and protective systems intended for use in potentially explosive atmospheres (ATEX Directive)
- 2014/53/EU
Radio equipment (RED)
- 2011/65/EU
Restriction of the use of certain hazardous substances (RoHS Directive)
- 2012/19/EU
Waste electrical and electronic equipment (WEEE Directive)

The standards used as the basis for the aforementioned directives have been at the heart of our development standard for some time as a way of ensuring compliance with European directives. The numbers of the directives indicate their version at the time of publication. In the event of changes to directives and/or standards, our products will undergo conformity assessment again in good time and a new declaration of conformity will be issued promptly. The current declarations for each product can also be found in our download area.

Among the aforementioned European directives, the EMC Directive plays a particularly important role. It uses a directive enshrined in national legislation as the basis for defining electromagnetic compatibility as a fundamental device property. European legislation therefore places great emphasis on the electromagnetic compatibility of devices and systems as a basic prerequisite for the error-free operation of machines and systems. As an international leader in the field of surge protection, Phoenix Contact has extensive expertise in EMC. This expertise and the experience gained over many years in the development and application of industrial interface and communication technology have resulted in an extremely high standard of quality for our products when it comes to electromagnetic compatibility. Our independent laboratory, Phoenix Testlab, was founded in order to share this expertise with other companies. Phoenix Testlab GmbH is an

accredited service company, which carries out EMC testing in compliance with European standards. At Phoenix Testlab, devices are also tested with regard to their electrical safety, mechanical influences, and their behavior in relation to environmental influences. Phoenix Testlab is also a notified body in accordance with EMC Directive 2014/30/EU and Radio Equipment Directive (RED) 2014/53/EU. As a certification body (TCB, FCB, and RCB), Phoenix Testlab is also able to approve these products for the markets in the USA, Canada, and Japan.

Standards and regulations

All relevant standards and regulations are used as the basis for the development and maintenance of our products.

International standards are subject to continuous changes as a result of harmonization and new developments. In line with this process, the current version of all standards that are relevant to our products is documented in the product area on our website at phoenixcontact.net/products.

Online product information service on the world wide web















































Phoenix Contact is continuously extending its product range.

Within the scope of our product monitoring obligation, all products are subject to an improvement process.

The Internet is an ideal platform to quickly communicate new product developments and improvements to the market.

You can quickly access the relevant Phoenix Contact website for your region via phoenixcontact.com. There you will always find an up-to-date overview of products, solutions, and services from Phoenix Contact. This includes technical documents such as data sheets and user manuals, current driver and demo software, and a direct link to the relevant contact person.

Certification authorities and marks

Certification authorities and approvals	Country code	Explosion protection	Country code	Marine classification societies	Country code
 IECEx CB Scheme (in combination with certifying body)	International	 International Electrotechnical Commission	International	 DNV GL - MARITIME	DE
 CENELEC Certification Agreement (CCA inspection report) (in combination with certifying body)	EU	 ATEX Directive	EU	 Bureau Veritas	FR
 Canadian Standards Association (CSA)	CA	 Canadian Standards Association (CSA)	CA	 Lloyd's Register of Shipping	GB
 Canadian Standards Association (CSA) - CSA approval for the USA -	US	 Canadian Standards Association (CSA) - CSA approval for the USA -	US	 Nippon Kaiji Kyokai	JP
 Canadian Standards Association (CSA) combined logo - CSA approval for Canada and the USA -	CA US	 Canadian Standards Association (CSA) combined logo - CSA approval for Canada and the USA -	CA US	 Polski Rejestr Statków	PL
 Underwriters Laboratories Inc. (UL)	US	 Underwriters Laboratories Inc. (UL)	US	 Russian Maritime Register of Shipping	RU
 Underwriters Laboratories Inc. (UL) - UL approval for Canada -	CA	 Underwriters Laboratories Inc. (UL) - UL approval for Canada -	CA	 Korean Register of Shipping	KR
 Underwriters Laboratories Inc. (UL) combined logo - UL approval for the USA and Canada -	US CA	 Underwriters Laboratories Inc. (UL) combined logo - UL approval for the USA and Canada -	US CA	 American Bureau of Shipping	US
 INSIEME PER LA QUALITA'E LA SICUREZZA	IT	 FM Approvals	US	 Registro Italiano Navale	IT
 Eurasian Conformity	EAEU	 FM Approvals - FM approval for Canada -	CA		
 DEKRA Certification B.V.	NL	 FM Approvals - FM approval for the USA and Canada -	US CA		
 Österreichischer Verband für Elektrotechnik	AT	 Eurasian Conformity for Ex-products	EAEU		
 Eurofins Electrosuisse Product Testing AG SEV certification scheme	CH	 Korean Certification Mark for Ex-products	KR		
 Verband Deutscher Elektrotechniker e.V. (VDE) - Approval of drawings - Reports with production monitoring	DE	 National Institute of Metrology, Standardization and Industrial Quality	BR		
 Berufsgenossenschaft (BG) GS - Geprüfte Sicherheit (tested safety)	DE	 National Supervision and Inspection Center for Explosion Protection and Safety of Instrumentation	CN		
 Intertek ETL Listed - Approval for the USA -	US	 Corp. Centro de Investigación y Desarrollo Tecnológico del Sector Eléctrico	CO		
 Intertek ETL Listed - Approval for Canada -	CA				
 Intertek ETL Listed - Approval for the USA and Canada -	US CA				
 TÜV Rheinland Industrie Service GmbH	DE				
 China Compulsory Certification	CN				
 Korean Certification Mark	KR				

Index

Alphabetical

Type	Order No.	Page	Type	Order No.	Page	Type	Order No.	Page	Type	Order No.	Page
E											
EM-CP-PP-ETH	2902802	61	EVT1G3K-1AC32A-5,0M6,0ESBK01	1627356	24	EV-TAG3PC-1AC20A-4,0M2,5EHBK01	1628025	32			
EM-EV-CLR-12V	2903246	61	EVT1G3K-1AC32A-5,0M6,0ESBK11	1628126	25	EV-TAG3PC-1AC20A-5,0M2,5ESBK01	1628027	32			
EV-CC-AC1-M3-CBC-RCM-ETH	1018701	60	EVT1GBIE12-1ACDC-32A125A2,0M1	1627896	52	EV-TAG3PC-1AC32A-4,0M6,0EHBK01	1628026	32			
EV-CC-AC1-M3-CBC-RCM-ETH-3G	1018702	60	EVT1GBIE12-1ACDC20A125A2,0M1	1624154	52	EV-TAG3PC-1AC32A-5,0M6,0ESBK01	1628028	32			
EV-CC-AC1-M3-CBC-SER-HS	1622452	62	EVT1GBIE12-1ACDC20A200A2,0M1	1018770	52	EV-TAG3PK-1AC20A-4,0M2,5EHBK01	1628020	32			
EV-CC-AC1-M3-CBC-SER-HS-MSTB	1081341	62	EVT1GBIE12-1ACDC32A200A2,0M1	1627098	52	EV-TAG3PK-1AC20A-5,0M2,5ESBK01	1628022	32			
EV-CC-AC1-M3-CBC-SER-PCB	1622453	64	EV-T2AC-PARK	1624148	45	EV-TAG3PK-1AC32A-4,0M6,0EHBK01	1628021	32			
EV-CC-AC1-M3-CBC-SER-PCB-MSTB	1627353	64	EV-T2CCS-MF-M4X10	1085797	41	EV-TAG3PK-1AC32A-5,0M6,0ESBK01	1628023	32			
EV-CC-AC1-M3-CBC-SER-PCB-XC	1628393	64	EV-T2CCS-MF-M4X10-BIT	1085798	41	EV-TBG3JC-1AC32A-5,0M6,0ESBK01	1627688	33			
EV-CC-AC1-M3-CBC-SER-PCB-XC-25	1627743	64	EV-T2CCS-MF-M4X10-BIT-CTS	1085799	40	EV-TCG3PK-1AC32A-5,0M6,0ESBK01	1050702	33			
EV-CC-AC1-M3-CC-SER-HS	1622459	63	EVT2CCS-PARK	1624153	43	EV-TCG3PK-3AC32A-5,0M6,0ESBK01	1628001	33			
EV-CC-AC1-M3-CC-SER-HS-MSTB	1081335	63	EV-T2G3C-1AC20A-4,0M2,5EHBK01	1627126	22	EV-TDG3JK-1AC16A-5,0M2,5ESBK01	1627756	33			
EV-CC-AC1-M3-CC-SER-PCB	1622460	65	EV-T2G3C-1AC20A-4,0M2,5EHBK11	1056548	20	EV-TDG3JK-1AC32A-5,0M6,0ESBK01	1022285	33			
EV-CC-AC1-M3-CC-SER-PCB-MSTB	1627367	65	EV-T2G3C-1AC20A-5,0M2,5ESBK01	1627354	22						
EV-CC-AC1-M3-CC-SER-PCB-XC	1628394	65	EV-T2G3C-1AC20A-5,0M2,5ESBK11	1056696	20						
EV-CC-AC1-M3-CC-SER-PCB-XC-25X	1627742	65	EV-T2G3C-1AC32A-4,0M6,0EHBK01	1627127	22						
EV-CC-S-SUITE-CP10	1086929	76	EV-T2G3C-1AC32A-4,0M6,0EHBK11	1056575	20						
EV-CC-S-SUITE-CP30	1086921	77	EV-T2G3C-1AC32A-5,0M6,0ESBK01	1627366	22						
EV-CC-S-SUITE-CP50	1086920	77	EV-T2G3C-1AC32A-5,0M6,0ESBK11	1097298	20						
EV-CC-S-SUITE-UPG10-30	1086891	77	EV-T2G3C-3AC20A-4,0M2,5EHBK01	1627128	23						
EV-CC-S-SUITE-UPG30-50	1086889	77	EV-T2G3C-3AC20A-4,0M2,5EHBK11	1097295	21						
EV-GBAC-PARK	1624142	45	EV-T2G3C-3AC20A-5,0M2,5ESBK01	1627365	23						
EV-GBDC-PARK	1623770	43	EV-T2G3C-3AC20A-5,0M2,5ESBK11	1056697	21						
EV-GBDC-PARK-R	1623496	43	EV-T2G3C-3AC32A-4,0M6,0EHBK01	1627130	23						
EV-GBDC-PARK-SW	1623497	43	EV-T2G3C-3AC32A-4,0M6,0EHBK11	1056698	21						
EV-GBG3C-1AC16A-5,0M2,5ESBK01	1627599	27	EV-T2G3C-3AC32A-5,0M6,0ESBK01	1627355	23						
EV-GBG3C-1AC32A-5,0M6,0ESBK01	1627601	27	EV-T2G3C-3AC32A-5,0M6,0ESBK11	1056700	21						
EV-GBG3C-3AC16A-5,0M2,5ESBK01	1627600	27	EV-T2G3PC-1AC20A-4,0M2,5EHBK01	1627131	28						
EV-GBG3C-3AC32A-5,0M6,0ESBK01	1627602	27	EV-T2G3PC-1AC20A-5,0M2,5ESBK01	1627982	28						
EV-GBG3JK-1AC16A-5,0M2,5ESBK01	1623515	31	EV-T2G3PC-1AC20A-5,0M2,5ESBK11	1097301	30						
EV-GBG3JK-1AC32A-5,0M6,0ESBK01	1623516	31	EV-T2G3PC-1AC32A-4,0M6,0EHBK01	1627133	28						
EV-GBG3JK-3AC16A-5,0M2,5ESBK01	1623517	31	EV-T2G3PC-1AC32A-5,0M6,0ESBK01	1627801	28						
EV-GBG3JK-3AC32A-5,0M6,0ESBK01	1624138	31	EV-T2G3PC-1AC32A-5,0M6,0ESBK11	1097306	30						
EV-GBG3K-1AC16A-5,0M2,5ESBK01	1623510	27	EV-T2G3PC-3AC20A-4,0M2,5EHBK01	1627135	29						
EV-GBG3K-1AC32A-5,0M6,0ESBK01	1623511	27	EV-T2G3PC-3AC20A-5,0M2,5ESBK01	1628348	29						
EV-GBG3K-3AC16A-5,0M2,5ESBK01	1623512	27	EV-T2G3PC-3AC20A-5,0M2,5ESBK11	1097299	30						
EV-GBG3K-3AC32A-5,0M6,0ESBK01	1624137	27	EV-T2G3PC-3AC32A-4,0M6,0EHBK01	1627136	29						
EV-GBG3PC-1AC16A-5,0M2,5ESBK01	1627603	31	EV-T2G3PC-3AC32A-5,0M6,0ESBK01	1627692	29						
EV-GBG3PC-1AC32A-5,0M6,0ESBK01	1627605	31	EV-T2G3PC-3AC32A-5,0M6,0ESBK11	1628125	30						
EV-GBG3PC-3AC16A-5,0M2,5ESBK01	1627604	31	EV-T2GBIE12-1ACDC-20A125A2,0M2	1624131	50						
EV-GBG3PC-3AC32A-5,0M6,0ESBK01	1627606	31	EV-T2GBIE12-1ACDC-20A200A2,0M2	1628340	51						
EV-GBG4C-DC125A-5,0M35ESBK01	1031381	13	EV-T2GBIE12-1ACDC-32A125A2,0M2	1628385	50						
EV-GBG4C-DC180A-5,0M50ESBK01	1085611	13	EV-T2GBIE12-1ACDC-32A200A2,0M2	1018771	51						
EV-GBG4C-DC250A-5,0M70ESBK01	1031379	13	EV-T2GBIE12-3ACDC-20A125A2,0M2	1628386	50						
EV-GBM3SL12-1AC32A-0,7M6,0E10T	1039245	37	EV-T2GBIE12-3ACDC-20A200A2,0M2	1628387	51						
EV-GBM3SL12-3AC32A-0,7M6,0E10T	1050941	37	EV-T2GBIE12-3ACDC-32A125A2,0M2	1627096	50						
EV-GBM4I-DC-125A2,0M	1627493	53	EV-T2GBIE24-1ACDC-20A125A2,0M2	1627097	51						
EV-GBM4I-DC-250A2,0M	1039550	53	EV-T2GBIE24-3ACDC-20A200A2,0M2	1004842	51						
EV-GBSCO	1623416	47	EV-T2GBIE24-1ACDC-32A125A2,0M2	1018767	50						
EV-PLCC-AC1-DC1	1624130	57	EV-T2GBIE24-1ACDC-32A200A2,0M2	1018762	50						
EV-RCM-C1-AC30-DC6	1622450	67	EV-T2GBIE24-3ACDC-32A200A2,0M2	1004844	50						
EV-RCM-C2-AC30-DC6	1622451	67	EV-T2HPCC-DC400A-5,0M50ECBK11	1085638	17						
EV-SETT2AC-ADV-RCM2-32AC5MES	1628081	71	EV-T2HPCC-DC500A-5,0M50ECBK11	1085637	16						
EV-SETT2AC-ADV-RCM2-32ASE12	1628082	71	EV-T2HPCC-DC400A-5,0M50ECBK11R	1089664	16						
EV-SETT2AC-BAS-RCM1-20AC5MES	1628077	70	EV-T2HPCC-DC500A-5,0M50ECBK11S	1052444	17						
EV-SETT2AC-BAS-RCM1-20ASE12	1628080	70	EV-T2HPCC-DC500A-5,0M50ECBK11S	1085631	17						
EV-T1AC-PARK	1624139	44	EV-T2M3SE12-1AC32A-0,7M6,0E10	1628124	36						
EV-T1CCS-PARK	1624143	42	EV-T2M3SE12-1AC32A-0,7M6,0E12	1628147	36						
EV-T1G2C-1AC15A-5,0M14ASBK01	1628014	26	EV-T2M3SE12-3AC20A-0,7M2,5E10	1405213	36						
EV-T1G2C-1AC32A-5,0M10ASBK01	1628422	26	EV-T2M3SE12-3AC20A-0,7M2,5E14	1627985	36						
EV-T1G2K-1AC15A-5,0M14ASBK01	1627757	26	EV-T2M3SE12-3AC32A-0,7M6,0E10	1405214	36						
EV-T1G2K-1AC15A-5,0M14ASBK11	1064753	26	EV-T2M3SE12-3AC32A-0,7M6,0E14	1627693	36						
EV-T1G2K-1AC32A-5,0M10ASBK01	1628419	26	EV-T2M3SE24-3AC20A-0,7M2,5E10	1405215	36						
EV-T1G2K-1AC32A-5,0M10ASBK11	1064755	26	EV-T2M3SE24-3AC20A-0,7M2,5E14	1627986	36						
EV-T1G3C-1AC20A-4,0M2,5EHBK01	1627345	24	EV-T2M3SE24-3AC32A-0,7M6,0E10	1405216	36						
EV-T1G3C-1AC20A-5,0M2,5ESBK01	1628013	24	EV-T2M3SE24-3AC32A-0,7M6,0E14	1627987	36						
EV-T1G3C-1AC30A-5,0M6,0ESBK11	1033865	25	EV-T2M4CC-DC150A-5,0M50ESBK11	1095767	12						
EV-T1G3C-1AC32A-4,0M6,0EHBK01	1627344	24	EV-T2M4CC-DC200A-5,0M70ESBK11	1095775	12						
EV-T1G3C-1AC32A-5,0M6,0ESBK01	1628096	24	EV-T2M4CC-DC80A-5,0M16ESBK11	1095764	12						
EV-T1G3K-1AC20A-4,0M2,5EHBK01	1623238	24	EV-T2SC	1405217	46						
EV-T1G3K-1AC20A-5,0M2,5ESBK01	1627362	24	EV-T2SC-EM	1627635	46						
EV-T1G3K-1AC20A-5,0M2,5ESBK11	1060405	25	EV-T2SC-EMF	1069199	46						
EV-T1G3K-1AC30A-5,0M6,0ESBK11	1033864	25	EV-T2SF	1405218	46						
EV-T1G3K-1AC32A-4,0M6,0EHBK01	1623239	24	EV-T2SF-EM	1627637	46						

For up-to-date modifications or supplements
to the catalog contents, please visit:
phoenixcontact.net/webcode/#0132

