



Thermal Overload Relays for Direct Mounting 120



Thermal Overload Relays for Separate Mounting 122



Accessories 123



Technical Data 125

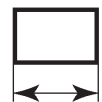

Dimensions 129

Thermal Overload Relays for plug-in mounting

Setting Range
D.O.L. (A) Δ (A) **Type** Pack pcs. Weight kg/pc. Wiring Diagram

With Manual Reset, for contactors K1-..



0,12	-	0,18	-	U12/16E 0,18 K1	1	0,10
0,18	-	0,27	-	U12/16E 0,27 K1	1	0,10
0,27	-	0,4	-	U12/16E 0,4 K1	1	0,10
0,4	-	0,6	-	U12/16E 0,6 K1	1	0,10
0,6	-	0,9	-	U12/16E 0,9 K1	1	0,10
0,8	-	1,2	-	U12/16E 1,2 K1	1	0,10
1,2	-	1,8	-	U12/16E 1,8 K1	1	0,10
1,8	-	2,7	-	U12/16E 2,7 K1	1	0,10
2,7	-	4	-	U12/16E 4 K1	1	0,10
4	-	6	7 - 10,5	U12/16E 6 K1	1	0,10
6	-	9	10,5 - 15,5	U12/16E 9 K1	1	0,10
8	-	11	14 - 19	U12/16E 11 K1	1	0,10
10	-	14	18 - 24	U12/16E 14 K1	1	0,10

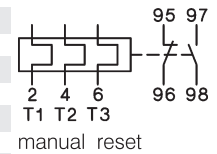

With Auto Reset, for contactors K1-..



0,12	-	0,18	-	U12/16A 0,18 K1	1	0,10
0,18	-	0,27	-	U12/16A 0,27 K1	1	0,10
0,27	-	0,4	-	U12/16A 0,4 K1	1	0,10
0,4	-	0,6	-	U12/16A 0,6 K1	1	0,10
0,6	-	0,9	-	U12/16A 0,9 K1	1	0,10
0,8	-	1,2	-	U12/16A 1,2 K1	1	0,10
1,2	-	1,8	-	U12/16A 1,8 K1	1	0,10
1,8	-	2,7	-	U12/16A 2,7 K1	1	0,10
2,7	-	4	-	U12/16A 4 K1	1	0,10
4	-	6	7 - 10,5	U12/16A 6 K1	1	0,10
6	-	9	10,5 - 15,5	U12/16A 9 K1	1	0,10
8	-	11	14 - 19	U12/16A 11 K1	1	0,10
10	-	14	18 - 24	U12/16A 14 K1	1	0,10

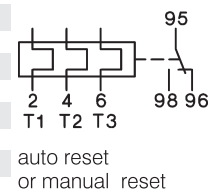

With Quick Tripping Characteristic for EEx e motors and submersible pumps, f. contactors K1-..



0,4	-	0,6	-	U12/16EQ 0,6 K1	1	0,10
0,6	-	0,9	-	U12/16EQ 0,9 K1	1	0,10
0,8	-	1,2	-	U12/16EQ 1,2 K1	1	0,10
1,2	-	1,8	-	U12/16EQ 1,8 K1	1	0,10
1,8	-	2,7	-	U12/16EQ 2,7 K1	1	0,10
2,7	-	4	-	U12/16EQ 4 K1	1	0,10
4	-	6	7 - 10,5	U12/16EQ 6 K1	1	0,10
6	-	9	10,5 - 15,5	U12/16EQ 9 K1	1	0,10
8	-	11	14 - 19	U12/16EQ 11 K1	1	0,10
10	-	14	18 - 24	U12/16EQ 14 K1	1	0,10

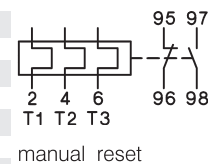

Thermal Overload Relays for plug-in mounting

Setting Range
D.O.L. (A) Δ (A)

Type

Pack pcs. Weight kg/pc. Wiring Diagram

With Manual Reset, for contactors K(G)3-10.. to K(G)3-22.. ..



0,12 - 0,18	-		U12/16E 0,18 K3	1	0,10
0,18 - 0,27	-		U12/16E 0,27 K3	1	0,10
0,27 - 0,4	-		U12/16E 0,4 K3	1	0,10
0,4 - 0,6	-		U12/16E 0,6 K3	1	0,10
0,6 - 0,9	-		U12/16E 0,9 K3	1	0,10
0,8 - 1,2	-		U12/16E 1,2 K3	1	0,10
1,2 - 1,8	-		U12/16E 1,8 K3	1	0,10
1,8 - 2,7	-		U12/16E 2,7 K3	1	0,10
2,7 - 4	-		U12/16E 4 K3	1	0,10
4 - 6	7 - 10,5		U12/16E 6 K3	1	0,10
6 - 9	10,5 - 15,5		U12/16E 9 K3	1	0,10
8 - 11	14 - 19		U12/16E 11 K3	1	0,10
10 - 14	18 - 24		U12/16E 14 K3	1	0,10
13 - 18	23 - 31		U12/16E 18 K3	1	0,10
17 - 23	30 - 40		U12/16E 23 K3	1	0,10
22 - 30	38 - 52		U12/16E 30 K3	1	0,13

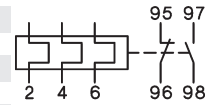

manual reset

With quick Tripping Characteristic for EEx e motors and under water pumps



0,4 - 0,6	-		U12/16EQ 0,6 K3	1	0,10
0,6 - 0,9	-		U12/16EQ 0,9 K3	1	0,10
0,8 - 1,2	-		U12/16EQ 1,2 K3	1	0,10
1,2 - 1,8	-		U12/16EQ 1,8 K3	1	0,10
1,8 - 2,7	-		U12/16EQ 2,7 K3	1	0,10
2,7 - 4	-		U12/16EQ 4 K3	1	0,10
4 - 6	7 - 10,5		U12/16EQ 6 K3	1	0,10
6 - 9	10,5 - 15,5		U12/16EQ 9 K3	1	0,10
8 - 11	14 - 19		U12/16EQ 11 K3	1	0,10
10 - 14	18 - 24		U12/16EQ 14 K3	1	0,10

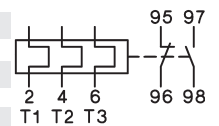

manual reset

For contactors K(G)3-10.. to K(G)3-40A..



0,12 - 0,18	-		U3/32 0,18	1	0,14
0,18 - 0,27	-		U3/32 0,27	1	0,14
0,27 - 0,4	-		U3/32 0,4	1	0,14
0,4 - 0,6	-		U3/32 0,6	1	0,14
0,6 - 0,9	-		U3/32 0,9	1	0,14
0,8 - 1,2	-		U3/32 1,2	1	0,14
1,2 - 1,8	-		U3/32 1,8	1	0,14
1,8 - 2,7	-		U3/32 2,7	1	0,14
2,7 - 4	-		U3/32 4	1	0,14
4 - 6	7 - 10,5		U3/32 6	1	0,14
6 - 9	10,5 - 15,5		U3/32 9	1	0,14
8 - 11	14 - 19		U3/32 11	1	0,14
10 - 14	18 - 24		U3/32 14	1	0,14
13 - 18	23 - 31		U3/32 18	1	0,14
17 - 24	30 - 41		U3/32 24	1	0,14
23 - 32	40 - 55		U3/32 32	1	0,14

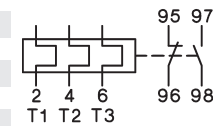

manual and auto reset

For contactors K(G)3-24A.. to K(G)3-40A ..



10 - 14	18 - 24		U3/42 14	1	0,30
14 - 20	24 - 35		U3/42 20	1	0,30
20 - 28	35 - 48		U3/42 28	1	0,30
28 - 42	48 - 73		U3/42 42	1	0,30

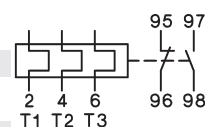

manual and auto reset

Thermal Overload Relays for plug-in mounting



Setting Range
D.O.L. (A) Δ (A)

Type

Pack pcs. Weight kg/pc.

Wiring Diagram

For contactors K3-50A.. to K3-74A..

20 - 28	35 - 48	U3/74 28	1	0,40
28 - 42	48 - 73	U3/74 42	1	0,40
40 - 52	70 - 90	U3/74 52	1	0,40
52 - 65	90 - 112	U3/74 65	1	0,40
60 - 74	104 - 128	U3/74 74	1	0,40

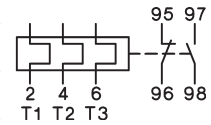

manual and auto reset

Thermal Overload Relays for separate mounting



Setting Range
D.O.L. (A) Δ (A)

Type

Pack pcs. Weight kg/pc.

Wiring Diagram

For contactors K3-90, K3-115, K85, K110

60 - 90	104 - 156	U85 90	1	0,90
80 - 120	140 - 207	U85 120		

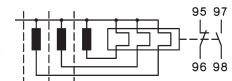

manual reset



For contactors K3-151.. and K3-176.., busbars included

120 - 180	208 - 312	U180 180	1	1,5
------------------	-----------	-----------------	---	-----

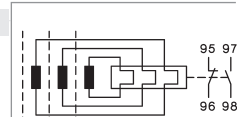

manual and auto reset



For contactors K3-210.. up to K3-316.., busbars included

144 - 216	250 - 374	U320 216	1	1,8
216 - 320	374 - 554	U320 320		

For contactors K3-315.., K3-450.., K3-550.., K3-700.., K3-860..

240 - 360	416 - 623	U800 360	1	4,1
360 - 540	623 - 935	U800 540	1	4,1
540 - 800	935 - 1385	U800 800	1	4,1



With Slow Tripping Characteristic for heavy duty starting with long run up times

For separate mounting, suitable for all contactors

0,8 - 1,2	1,2 - 2,1	UAT21 1,2	1	1,0
1,2 - 1,8	2,1 - 3,1	UAT21 1,8	1	1,0
1,6 - 2,4	2,8 - 4,2	UAT21 2,4	1	1,0

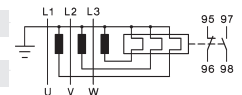

manual reset

2,4 - 3,7	4,2 - 6,4	UAT21 3,7	1	1,0
3,7 - 5,7	6,4 - 9,9	UAT21 5,7	1	1,0
5,3 - 8,2	9,2 - 14,2	UAT21 8,2	1	1,0

8 - 12	13,9 - 20,1	UAT21 12	1	1,0
12 - 18	20,1 - 31,2	UAT21 18	1	1,0

16 - 24	27,7 - 41,6	UAT22 24	1	1,1
----------------	-------------	-----------------	---	-----

24 - 37	41,6 - 64	UAT23 37	1	1,3
32 - 49	55,4 - 85	UAT23 49	1	1,3
48 - 72	83 - 125	UAT23 72	1	1,3

Accessories



for overload relays	for contactors	Type	Pack set	Weight kg/set
Busbar Sets				
U800	K3-450.., K3-550..	SU840/550	1	1,7
U800	K3-700.., K3-860..	SU840/860	1	2,1



for overload relay	Cable Cross-section (mm ²)		Type	Pack pcs.	Weight kg/pc.
	solid or stranded	flexible			
Set for Single Mounting on DIN-rail with terminals					
U12/16..K3	0,75 - 6	0,75 - 4	U12SM K3	1	0,035



Additional Terminals with fingertouch protection					
U3/32	0,75 - 6	0,75 - 4	U3/32SM	1	0,035



Set for Single Mounting on DIN-rail					
U3/42, U3/74	-	-	U3/42G	1	0,030



Connecting Wire Set for U3/42, U3/74 with Single Mounting					
U3/42, U3/74	150mm lang	10mm ²	LG5830-4	1	0,060
U3/42, U3/74	250mm lang	10mm ²	LG5830-2	1	0,100



Additional Terminals with fingertouch protection					
1-pole f. U12/16, U3/32	0,75 - 10	0,75 - 6	LG9339	1	0,009
3-pole for U3/42	4 - 35	6 - 25	LG7559	1	0,052

Thermal Overload Relays, tripping times for selection to motors of protection degree EEx e

Relays With Standard Tripping Characteristic

Setting Range Tripping time depending on the multiple of the current setting from cold condition (tolerance $\pm 20\%$ of the tripping time)

A	A	I_A/I_N 3	I_A/I_N 4	I_A/I_N 5	I_A/I_N 6	I_A/I_N 7,2	I_A/I_N 8
U3/32 ..							
	s	s	s	s	s	s	s
0,12 -	0,18	16,1	9,6	6,8	5,3	4,2	3,7
0,18 -	0,27	16,6	9,7	6,7	5,2	4,1	3,6
0,27 -	0,4	19,4	11,4	7,9	6,1	4,7	4,2
0,4 -	0,6	18,7	10,9	7,6	5,9	4,6	4,0
0,6 -	0,9	19,2	11,2	7,7	5,9	4,6	4,1
0,8 -	1,2	20,8	12,3	8,5	6,6	5,2	4,6
1,2 -	1,8	25,5	14,1	9,8	7,6	5,9	5,2
1,8 -	2,7	26,6	15,6	10,9	8,3	6,5	5,7
2,7 -	4	22,7	13,6	9,5	7,4	5,8	5,1
4 -	6	22,2	13,3	9,3	7,1	5,6	4,9
6 -	9	20,4	11,9	8,2	6,1	4,7	4,0
8 -	11	20,9	11,8	7,9	5,7	4,3	3,5
10 -	14	21,3	11,7	7,4	5,1	3,7	3,0
13 -	18	21,2	12,1	8,0	6,2	4,6	4,1
17 -	24	20,4	12,0	8,6	6,3	4,5	3,7
23 -	32	20,2	10,2	6,7	4,7	3,4	2,8

A	A	I_A/I_N 3	I_A/I_N 4	I_A/I_N 5	I_A/I_N 6	I_A/I_N 7,2	I_A/I_N 8
U3/42							
	s	s	s	s	s	s	s
10 -	14	21,8	11,4	7,0	5,0	3,7	2,8
14 -	20	22,4	11,2	6,7	4,5	3,2	2,4
20 -	28	21,8	10,8	6,5	4,5	3,3	2,5
28 -	42	25,2	13,3	8,0	5,5	4,0	3,1

A	A	I_A/I_N 3	I_A/I_N 4	I_A/I_N 5	I_A/I_N 6	I_A/I_N 7,2	I_A/I_N 8
U3/74							
	s	s	s	s	s	s	s
20 -	28	21,8	10,8	6,5	4,5	3,3	2,5
28 -	42	25,2	13,3	8,0	5,5	4,0	3,1
40 -	52	18,3	9,2	5,6	3,9	2,8	2,2
52 -	65	17,8	8,7	5,2	3,4	2,5	1,9

A	A	I_A/I_N 3	I_A/I_N 4	I_A/I_N 5	I_A/I_N 6	I_A/I_N 7,2	I_A/I_N 8
U85 ..							
	s	s	s	s	s	s	s
60 -	90	19,5	13,5	11,0	10,0	9,5	8,5
80 -	120	18,0	11,0	10,0	9,0	8,5	8,0

A	A	I_A/I_N 3	I_A/I_N 4	I_A/I_N 5	I_A/I_N 6	I_A/I_N 7,2	I_A/I_N 8
U840 ..							
	s	s	s	s	s	s	s
260 -	360	23,3	14,1	10,0	7,6	6,1	5,4
340 -	480	23,0	13,8	9,6	7,6	6,1	5,4
440 -	620	20,5	12,4	9,0	7,0	5,5	5,0
560 -	800	21,0	12,5	9,0	7,0	5,6	5,2

A	A	I_A/I_N 3	I_A/I_N 4	I_A/I_N 5	I_A/I_N 6	I_A/I_N 7,2	I_A/I_N 8
U12/16E(A) ..							
	s	s	s	s	s	s	s
0,12 -	0,18	18,5	10,4	7,2	5,5	4,3	3,6
0,18 -	0,27	16,7	9,8	6,5	5,0	4,1	3,5
0,27 -	0,4	19,4	12,1	8,2	5,9	4,9	4,2
0,4 -	0,6	18,7	11,2	8,0	6,0	4,9	4,1
0,6 -	0,9	19,7	11,6	8,1	6,1	4,9	4,2
0,8 -	1,2	22,9	13,6	10,0	7,3	6,0	5,2
1,2 -	1,8	22,2	13,2	9,2	7,6	5,8	5,3
1,8 -	2,7	23,0	13,7	9,3	7,6	5,7	5,1
2,7 -	4	24,0	14,4	9,9	7,8	5,9	5,1
4 -	6	24,7	13,8	9,9	7,3	5,6	4,8
6 -	9	22,0	13,4	8	5,7	4,1	3,5
8 -	11	17,4	9,2	5,9	4,1	2,9	2,3
10 -	14	26,4	12,9	7,6	5,2	3,5	2,8
13 -	18	14,7	7,7	4,8	3,2	2,3	1,7
17 -	23	16,2	8,4	5,0	3,6	2,4	1,8
22 -	30	16,8	8,5	5,0	3,6	2,3	1,9

Relays With Quick Tripping Characteristic

preferably for motors with short t_E time and for submersible pumps

Setting Range Tripping time depending on the multiple of the current setting from cold condition (tolerance $\pm 20\%$ of the tripping time)

A	A	I_A/I_N 3	I_A/I_N 4	I_A/I_N 5	I_A/I_N 6	I_A/I_N 7,2	I_A/I_N 8
U12/16EQ ..							
	s	s	s	s	s	s	s
0,4 -	0,6	13,6	8,4	5,9	4,2	3,3	3,0
0,6 -	0,9	13,8	7,8	5,2	4,1	3,2	2,7
0,8 -	1,2	13,1	7,5	5,2	3,9	3,1	2,7
1,2 -	1,8	14,6	8,7	6,0	4,6	3,6	3,2
1,8 -	2,7	13,5	7,6	5,3	3,9	3,1	2,7
2,7 -	4	11,0	6,0	4,1	2,6	1,7	1,4
4 -	6	9,6	5,3	3,3	2,3	1,6	1,3
6 -	9	10,2	5,4	3,4	2,3	1,6	1,3
8 -	11	12,0	6,2	3,9	2,5	1,8	1,3
10 -	14	12,8	6,6	4,0	2,6	1,8	1,4

All tripping times of overload relays U12/16EQ are shorter than the minimum values of the t_E time for motors of protection degree EEx e acc. to EN 50019 and therefore are suitable for all motors of protection degree EEx e. For these overload relays the selection on basis of tripping curves is thereby not necessary.

When selecting a standard overload, refer to the tripping curve. Determine the values of the starting current ratio I_A/I_N and the time t_E which is marked on the label of the motor. The overload must trip within the t_E time, which means that the tripping curve from cold condition must be (20% due to tolerance) below the co-ordination point I_A/I_N and the time t_E .
 I_A = Starting current of motor I_N = Rated current of motor
 t_E = t_E -time of motor

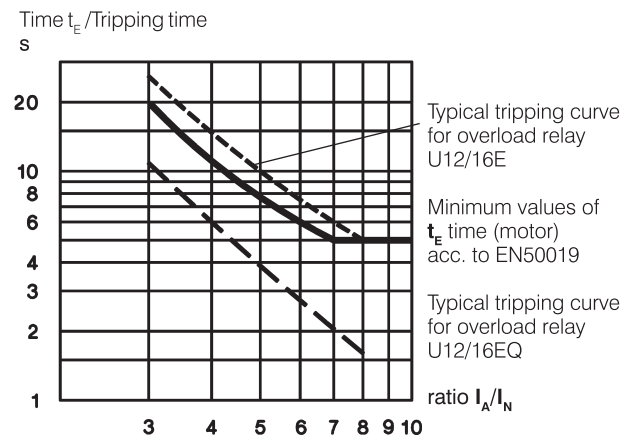

Labels of tripping curves for each setting range, sized 148x105mm (self-adhesive) are available on request. Order No. D588, specify type and setting range.

Example of selection for thermal overload relay:

Technical data of a motor protection EEx e
 $P_N = 1,5kW$ $I_N = 3,6A$ $I_A/I_N = 5$ t_E time = 8s

1) U12/16E 4 (2,7 - 4A)
 Tripping time at $5 \times I_N = 9,9s$
 $9,9s + 20\% \text{ tolerance} = 11,9s > t_{E \text{ Motor}} = 8s$
 The device U12/16E 4 is **not suitable**.

2) U12/16EQ 4 (2,7 - 4A)
 Tripping time at $5 \times I_N = 4,1s$
 $4,1s + 20\% \text{ tolerance} = 4,9s < t_{E \text{ Motor}} = 8s$
The device U12/16EQ 4 is therefore suitable for motor protection

Thermal Overload Relays

Fuses for U3/32, U3/42, U3/74, U12/16E, U85, U180, U320 and U800

Type	Setting Range		Max. Fuse Size According to Coordination-type				Fuse UL	SCCR	
	DOL	YΔ	"2" ¹⁾		"1" ¹⁾				
			A	A	quick A	slow, gL(gG) A	slow, gL(gG) A	aM A	A
U3/32 (U12/16E)	0,12 - 0,18	-		0,5 ²⁾	0,5 ²⁾	25	-	15	5
	0,18 - 0,27	-		1,0 ²⁾	1,0 ²⁾	25	-	15	5
	0,27 - 0,4	-		2	2	25	-	15	5
	0,4 - 0,6	-		2	2	25	-	15	5
	0,6 - 0,9	-		4	4	25	-	15	5
	0,8 - 1,2	-		4	4	25	2	15	5
	1,2 - 1,8	-		6	6	25	2	15	5
	1,8 - 2,7	-		10	10	25	4	15	5
	2,7 - 4	-		16	10	25	4	15	5
	4 - 6	7 - 10,5		20	16	25	6	15	5
	6 - 9	10,5 - 15,5		35	25	35	10	25	5
	8 - 11	14 - 19		35	25	35	16	30	5
	10 - 14	18 - 24		50	35	63	16	40	5
13 - 18	23 - 31		50	35	63	20	50	5	
17 - (23)24	30 - (40)41		63	50	63	25	60	5	
(22)23	- (30)32	(38)40 - (52)55	80	63	80	35	70	5	
U3/42	10 - 14	18 - 24	50	35	80	16	40	5	
	14 - 20	24 - 35	63	50	80	25	60	5	
	20 - 28	35 - 48	80	63	80	35	80	5	
	28 - 42	48 - 73	100	80	150	50	110	5	
U3/74	20 - 28	35 - 48	100	80	150	35	80	5	
	28 - 42	48 - 73	125	100	150	50	110	5	
	40 - 52	70 - 90	160	100	150	63	200	5	
	52 - 65	90 - 112	160	125	150	80	250	10	
	60 - 74	104 - 128	160	125	150	80	250	10	
U85	60 - 90	104 - 156					300	10	
	80 - 120	140 - 207					-	10	
U180, U320 U800	all ranges all ranges						-	-	

For short circuit protecting overload relays with current transformer use fuse according to the contactor of the combination.

Tripping Characteristics for U3/32, U3/42, U3/74 and U12/16E

Detailed tripping times for each range see table page 124

with three-phase load

Tripping time (Average value of typical tolerance curves from cold condition)

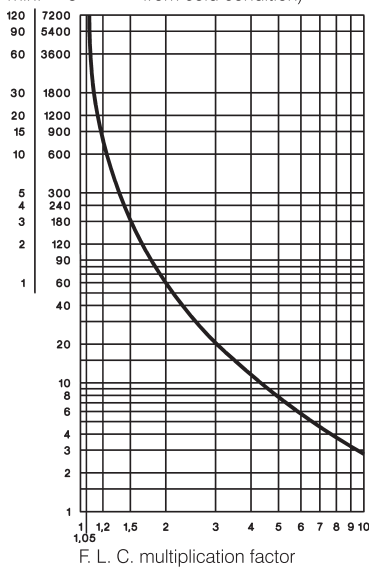

with two-pole load

Tripping time (Typical tolerance curve from cold condition)

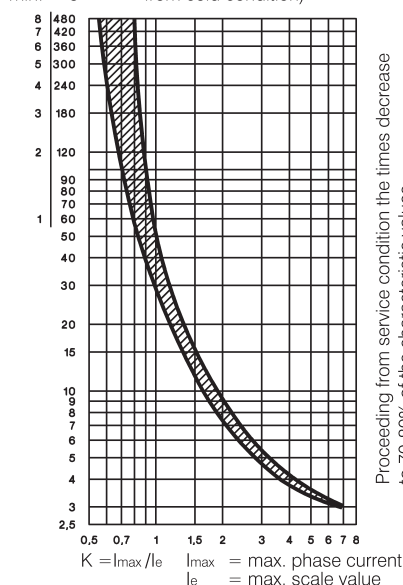

- 1) Coordination-type according to IEC 947-4-1:
"2": Light contact welding accepted. Thermal overload relay must not be damaged.
"1": Welding of contactor and damage of the thermal overload relay allowed.
- 2) Miniature fuse

- 3) Suitable for use on a capability of delivering not more than

Thermal Overload Relays

Tripping Characteristics for U85, U180, U320, and U800

Detailed tripping times for each range of U85 see table page 124

U85 with three-phase load

Tripping time (Average value of typical tolerance curves from cold condition)

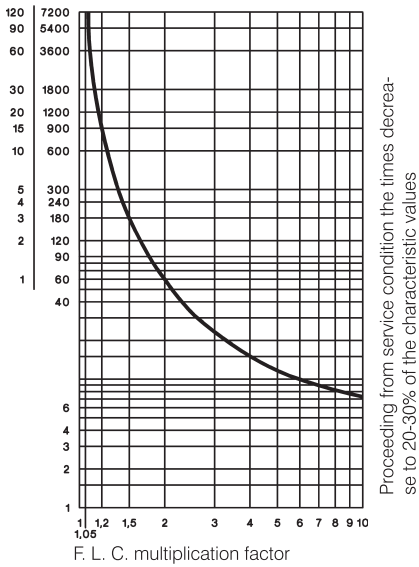

U180, U320 with three-phase load

Tripping time (Average value of typical tolerance curves from cold condition)

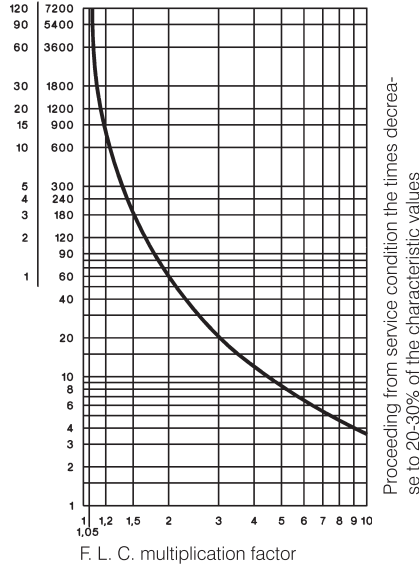

U800 with three-phase load

Tripping time (Average value of typical tolerance curves from cold condition)

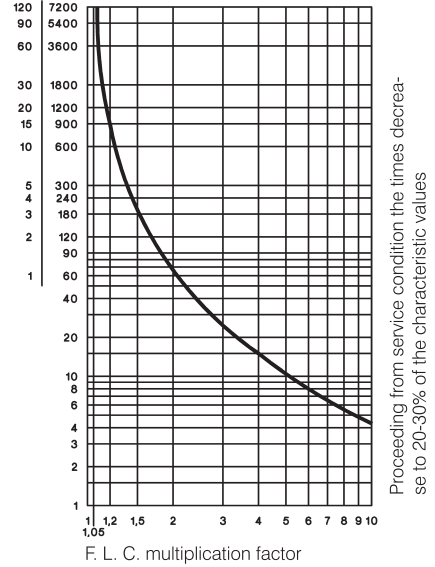

U85 with two-pole load

Tripping time (Typical tolerance curve from cold condition)

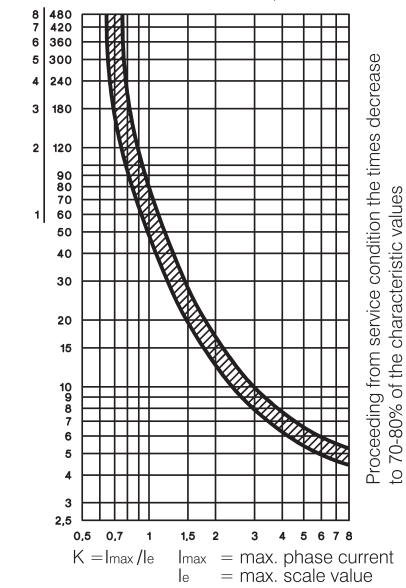

Position of Terminals

U3/32

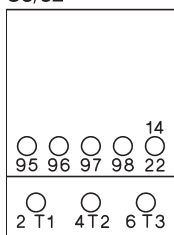

U12/16E, U12/16EM, U12/16EQ

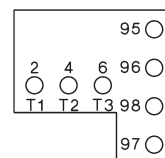

U12/16A

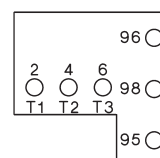

U3/42, U3/74

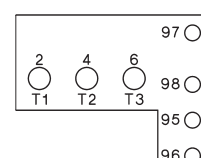

Thermal Overload Relays in Special Version

Fuse for U12/16EQ

Setting Range	Maximum Fuse Acc. to Coordination-type "2" ¹⁾		
	quick A	slow, gL(gG) A	slow, gL(gG) "1" ¹⁾ A
0,4 - 0,6	2	2	25
0,6 - 0,9	4	4	25
0,8 - 1,2	4	4	25
1,2 - 1,8	6	6	25
1,8 - 2,7	10	10	25
2,7 - 4	16	10	25
4 - 6	20	16	25
6 - 9	35	25	35
8 - 11	35	25	35
10 - 14	50	35	63

Fuse for U12/16EM

Setting Range	Maximum Fuse Acc. to Coordination-type "2" ¹⁾		
	380-400V slow, gL(gG) A	500V slow, gL(gG) A	660-690V slow, gL(gG) A
0,12 - 0,18	none	none	on request
0,18 - 0,27	none	none	on request
0,27 - 0,4	none	none	on request
0,4 - 0,6	none	none	on request
0,6 - 0,9	none	none	on request
0,8 - 1,2	none	10	on request
1,2 - 1,8	none	16	on request
1,8 - 2,7	20	20	on request
2,7 - 4	35	35	on request

Tripping Characteristic for U12/16EQ

Detailed tripping times for each range see table page 124

with three-phase load

range 0,4-0,6 to 1,8-2,7A

Tripping time (Typical tolerance curve from cold condition)

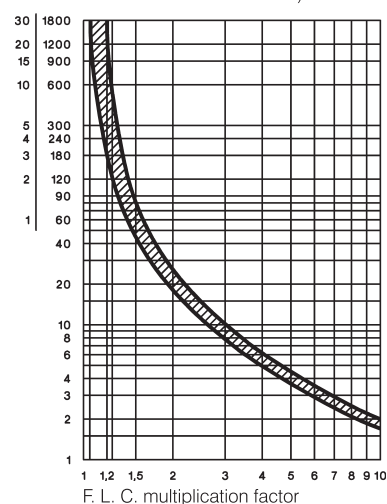

range 2,7-4 to 10-14A

Tripping time (Typical tolerance curve from cold condition)

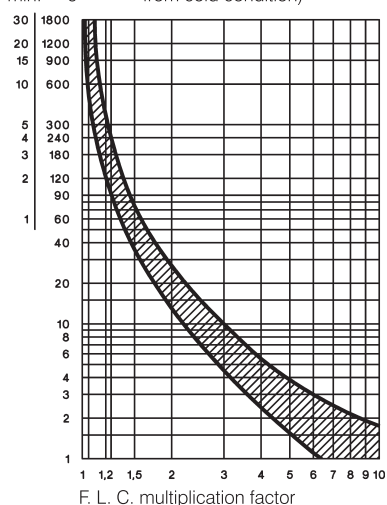

Tripping Characteristic for U12/16EM

with three-phase load

Tripping time (Average value of typical tolerance curves from cold condition)

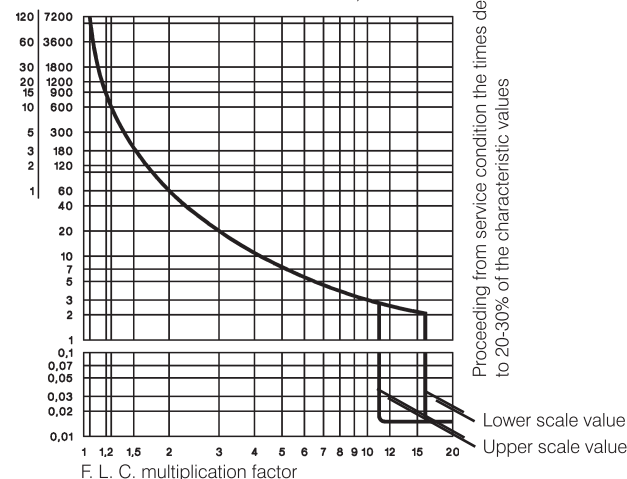

Fuse for UAT21, UAT22, UAT23

For short circuit protecting thermal overload relays with current transformer use fuse according to the contactor of the combination.

Tripping characteristic for UAT21, UAT22, UAT23

with three-phase load

Tripping time in s (Typical tolerance curve from cold condition)

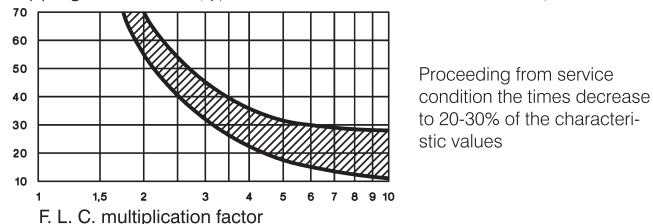

1) Coordination-type according to IEC 947-4-1:
 "2": Light contact welding accepted. Thermal overload relay must not be damaged.
 "1": Welding of contactor and damage of the thermal overload relay allowed.

Thermal Overload Relays

Data according to IEC 947-4-1, IEC 947-5-1, VDE 0660, EN 60947-4-1, EN 60947-5-1

Type	U3/32	U12/16 ⁶⁾	U3/42	U3/74	U85	U180	U320	U800	UAT21	UAT22	UAT23
Rated insulation voltage U_i¹⁾	690	690	690	690	750	1000	1000	1000	690	690	690
Permissible ambient temperature											
operation			-25 to +60					-25 to +55		-25 to +60	
storage			-50 to +70					-40 to +70		-50 to +70	
Trip class according to IEC 947-4-1	10A	10A	10A	10A	20	10A	10A	10	30	30	30
Cable cross-section											
main connector solid or stranded	0,75-6	0,75-6+0,75-2,5 ²⁾	0,75-10	4-35 ²⁾	3)	7)	-	7)	0,5-10	0,5-16	0,5-25
flexible	1-4	0,75-4+0,5-2,5 ²⁾	0,75-6	6-25 ²⁾					0,5-6	0,5-10	0,5-16
flexible with multicore cable end	0,75-4	0,5-2,5+0,5-1,5	0,75-6	4-25					0,5-6	0,5-10	0,5-16
Cables per clamp	2	1+1	2	1					1	1	1
auxiliary connector solid			0,75-2,5 ²⁾					1-2,5 ²⁾		0,75-2,5 ²⁾	
flexible			0,5-2,5 ²⁾					1-2,5 ²⁾		0,5-2,5 ²⁾	
flexible with multicore cable end			0,5-1,5					1-2,5 ²⁾		0,5-1,5	
Cables per clamp			2					2		2	

Type	U3/32	U12/16A	U12/16E	U12/16EQ	U3/42	U85	U180	U800	UAT21	UAT22	UAT23
Auxiliary contacts											
Rated insulation voltage U_i¹⁾											
same potential	690	690	690	690	690	690	690	500	690		
different potential	440	-	440	440	250	440	440	500	440		
Utilization category AC15											
Rated operational current I _e											
24V A	3	4	5	5	4	5	3	4 ⁵⁾	5		
230V A	2	2,5	3	3	2,5	3	2	2,5	3		
400V A	1	1,5	2	2	1,5	2	1	1,5	2		
690V A	0,5	0,6	0,6	0,6	0,6	0,6	0,5	0,6	0,6		
Utilization category DC13											
Rated operational current I _e											
24V A	1	1,2	1,2	1,2	1,2	1,2	1	1,2	1,2		
110V A	0,15	0,15	0,15	0,15	0,15	0,15	0,15	0,15	0,15		
220V A	0,1	0,1	0,1	0,1	0,1	0,1	0,1	0,1	0,1		
Short circuit prot. (without welding 1kA)											
highest fuse rating	4	4	6	6	6	6	4	6	6		

Type	U3/32	U12/16	U12/16E	U3/42	U3/42	U3/74	U3/74	U85
Setting range	all	to 23A	22 - 30A	to 28A	28 - 42A	to 52A	52 - 65A	all
Power loss per current path (max.)								
minimum setting value	1,1	1,1	1,7	1,3	1,3	2,0	2,9	1,1
maximum setting value	2,3	2,3	3,7	2,6	3,3	3,7	4,5	2,5

Data according to cULus

Type	U3/32	U12/16A	U12/16E	U12/16EQ	U3/42	U3/74	U85
Rated insulation voltage	600	600	600	600	600	600	600
Rated current	32	23	23	23	42	75	85
Auxiliary contacts							
Rated voltage							
same potential	600	600	600	600	600	600	600
different potential	150	-	150	150	150	150	150
Switching capacity AC							
of aux. contacts	500	500	500	500	600	600	600
	2	3	4	4	4	4	4

Temperature Compensation

In case of higher ambient temperature use the following formula:
(Ambient temperature - 20) x 0,125 = correction factor in % of the full load motor current

Example: Ambient temperature 70°C, full load motor current 7A
(70 - 20) x 0,125 = 6,25%
Setting value: 7A + 6,25% = 7,44A

1) Suitable for: earthed-neutral systems, overvoltage category I to III, pollution degree 3 (standard-industry): U_{imp} = 4kV (at 440V), 6kV (at 690V).
 Data for other conditions on request.

2) Maximum cable cross-section with prepared conductor

3) Without terminals, suitable for bushing one connector 70mm² (stranded) per phase

4) Switching capacity of the start contact: AC15 300VA, max. 1,5A, DC13 (max. 220V) 30W, max. 1,5A

5) Switching capacity of the make contact: AC15 400VA, max. 1,7A, DC13 (max. 220V) 10W, max. 1A

6) U12/16E 30: Cable cross-section for main connector like type U3/42, one connector only

7) Busbar sets see accessories page 123

Thermal Overload Relays

Dimensions

K3-10N + U3/32

K3-14N

K3-18N

K3-22N

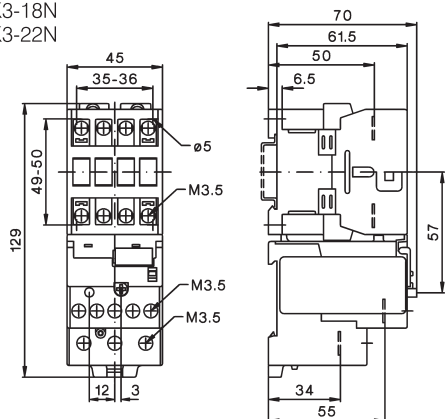

KG3-10 + U3/32

KG3-14

KG3-18

KG3-22

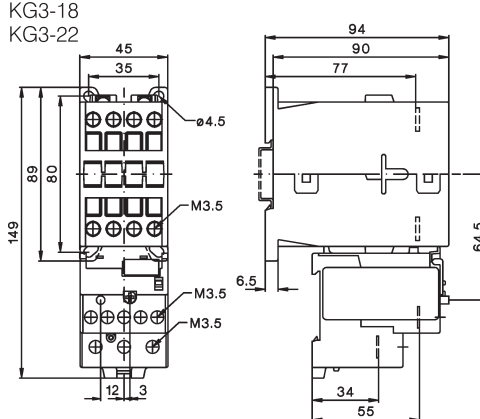

K3-24 + U3/32

K3-32

K3-40

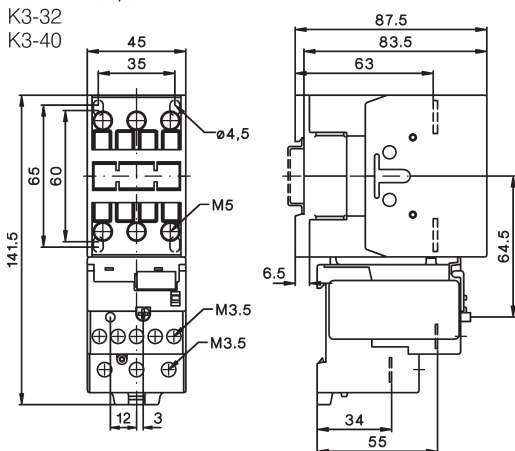

KG3-24 + U3/32

KG3-32

KG3-40

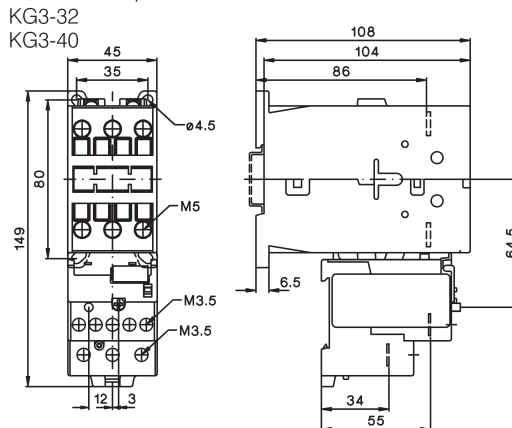

K3-24 + U3/42

K3-32

K3-40

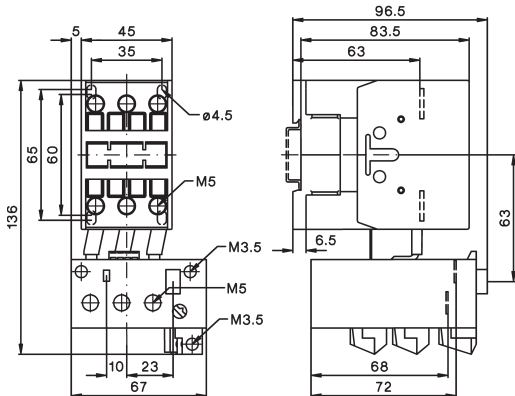

KG3-24 + U3/42

KG3-32

KG3-40

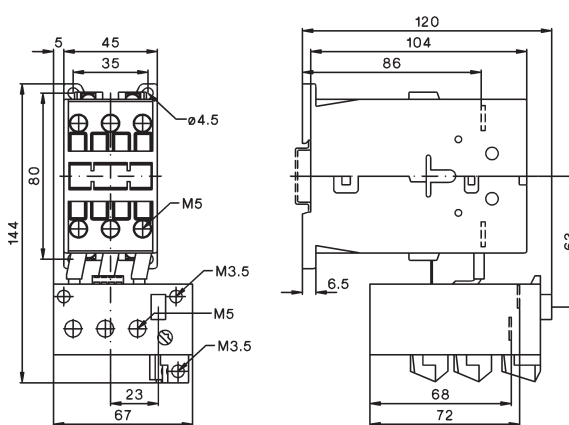

U3/32SM

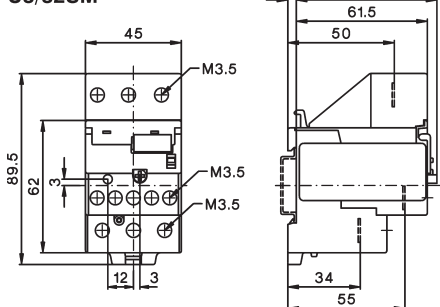

U3/42G + LG5830-

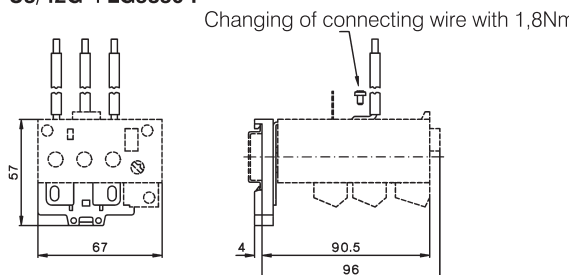

Thermal Overload Relays

Dimensions

K1-09 + U12/16..K1
K1-12

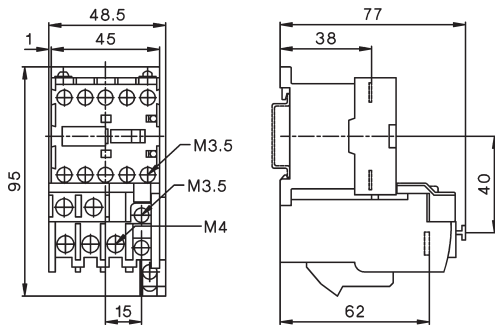

K3-10 + U12/16..K3
K3-14
K3-18
K3-22

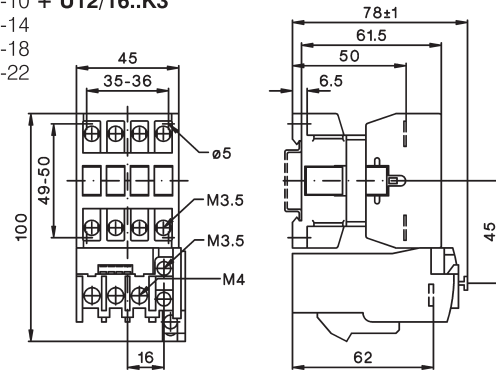

K3-10N + U12/16..K3
K3-14N
K3-18N
K3-22N

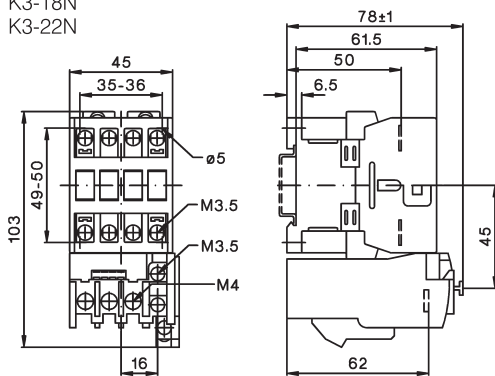

KG3-10 + U12/16..K3
KG3-14
KG3-18
KG3-22

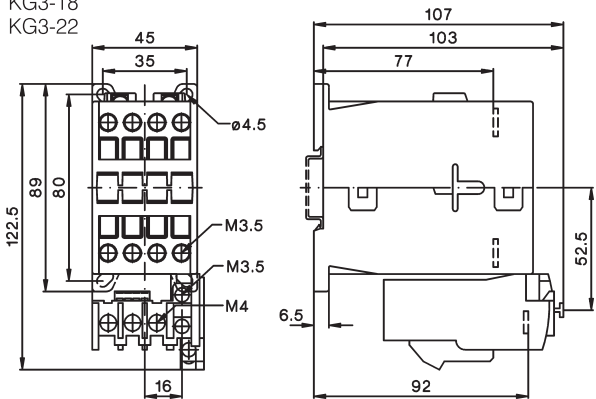

U12SM K3

U12/16..K3 + U12SM K3 for snap-on 35mm DIN-rail according to DIN EN50022 and screw mounting (single mounting)

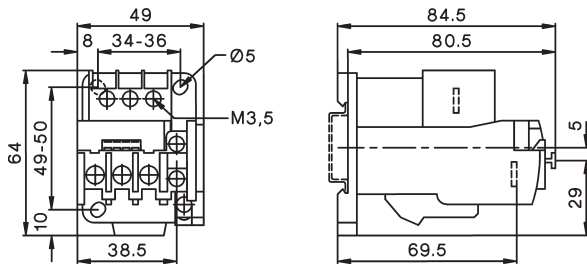

K3-50 + U3/74
K3-62
K3-74

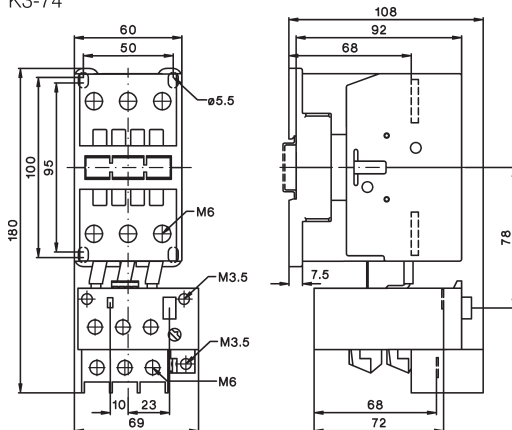

Thermal Overload Relays

Dimensions

K3-90A + U85
K3-115A

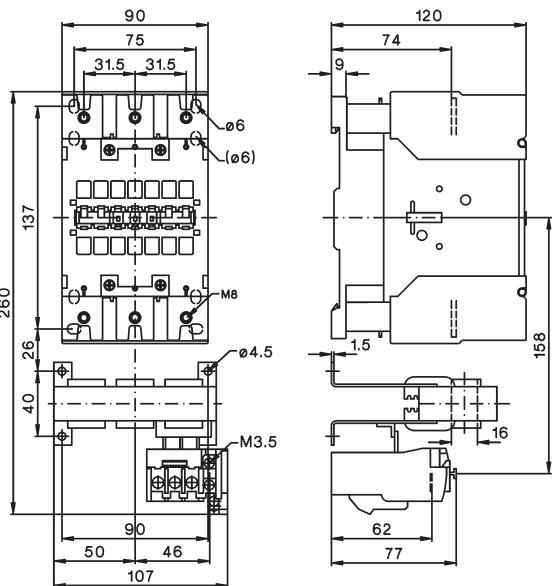

K3-151A00 + U180
K3-176A00

Mounting holes

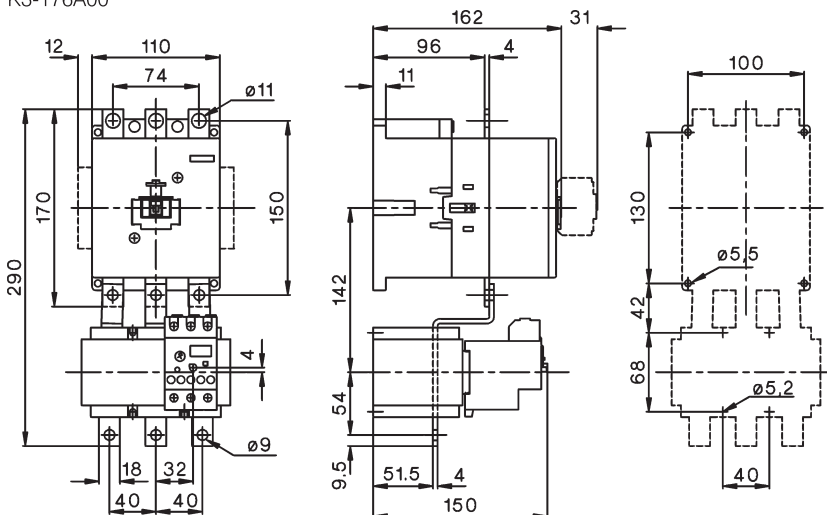

K3-210A00 + U320
K3-260A00
K3-316A00

Mounting holes

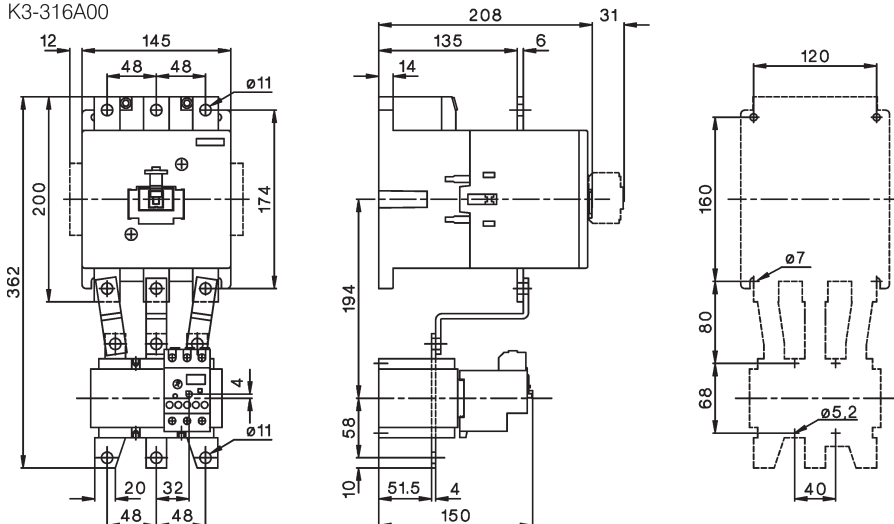

Thermal Overload Relays

Dimensions

U800

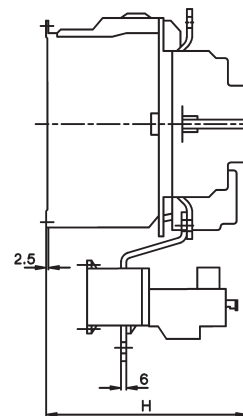
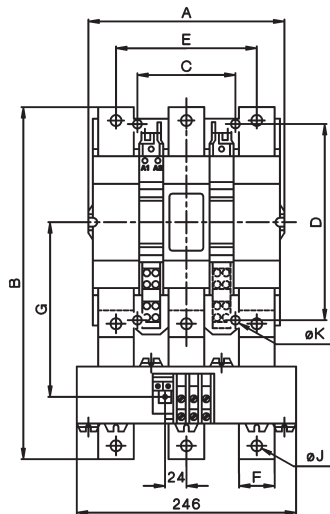
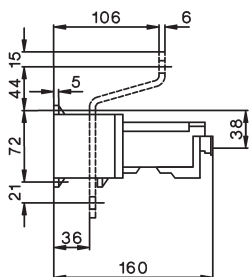
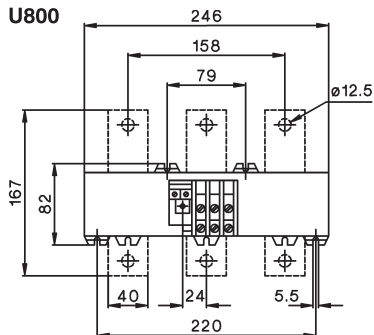

U800 with	A	B	C	D	E	F	G	H	J	K
K3-450	220	372	110	220	158	40	185	225	12,5	9
K3-550	220	395	110	220	158	40	196	225	12,5	9
K3-700	280	487	175	280	202	50	257	291	14,5	11
K3-860	280	540	175	280	202	50	280	291	14,5	11

UAT21

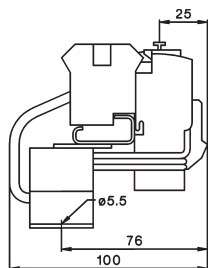
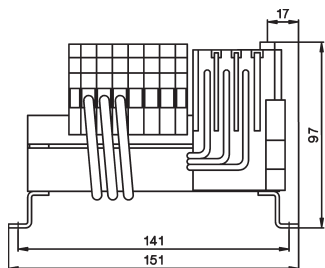

UAT22

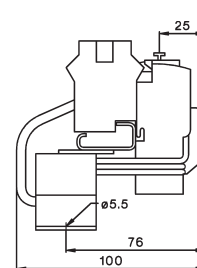
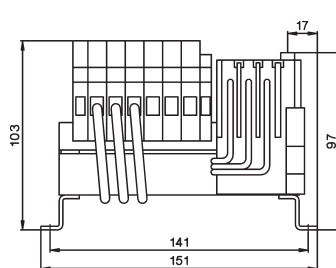

UAT23

Type	Setting Range	A	B
UAT23 37	23-37A	105,5	97,5
UAT23 49	32-49A	94	86
UAT23 72	48-72A	94	86

