



MBA 221275
Article No. 0101102100

Material: Aluminium
Protection class: IP66

MBA-Enclosures are universal, sturdy and easily adapt to the installation of electrical, electronic and pneumatic components. Manufacturing takes place using pressure die casting or gravity die casting methods.

MBA-Enclosures can be mechanically processed in a number of ways providing almost no limits to customised surface design.

As terminal enclosures they can be assembled according to a modular system with the addition of differing clamps and cable glands. In the measurement and control technology market they are often used for encapsulating sensors. Additionally they serve as junction boxes for cables and lines or take on the job of protecting highly sensitive electronics against water, dirt and dust.



We would be glad to assist you!

MULTI-BOX GmbH

Wallücker Bahndamm 7
D-32278 Kirchlengern
Tel. +49 (0)5223 49107-0

info@multi-box.com
www.multi-box.com

Dimensions and weight

| | |
|-------------|------|
| Length (mm) | 220 |
| Width (mm) | 120 |
| Height (mm) | 75 |
| Weight (g) | 1450 |

Color information

| | |
|-------------------------|------------|
| Color description cover | Light Grey |
| RAL-code cover | 7001 |
| Color description base | Light Grey |
| RAL-code base | 7001 |

Technical Drawings

| | |
|-----|--|
| PDF | |
| DXF | |
| 3D | |



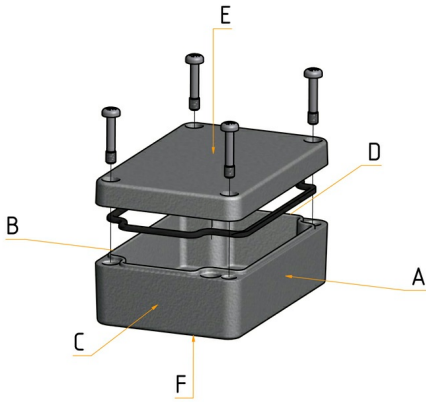

We would be glad to assist you!

MULTI-BOX GmbH

Wallücker Bahndamm 7
D-32278 Kirchlegern
Tel. +49 (0)5223 49107-0

info@multi-box.com
www.multi-box.com



Material information

| | |
|------------------|----------------------|
| Material cover | Aluminium |
| Material base | Aluminium |
| Material sealing | Polyurethane |
| Material screws | Stainless Steel V2 A |
| Silicone-free | ✓ |
| Halogen-free | ✓ |
| UV-resistant | ✓ |
| Surface coating | Powder coating |

Temperature resistance and application areas

| | |
|--|-----|
| Permanent operating temperature max. (°C) | 100 |
| Permanent operating temperature min. (°C) | -40 |
| Permanent operating temperature with special sealing max. (°C) | 140 |
| Permanent operating temperature with special sealing min. (°C) | -50 |
| Suitable for outdoor use | ✓ |
| Suitable for indoor use | ✓ |

Technical specifications



















| | |
|--|--------------|
| Protection class IP | 66 |
| Norm of protection class | DIN EN 60529 |
| Earthing point available | ✓ |
| Sealing foamed seamless | ✓ |
| Captive cover screws | ✓ |
| Assembly tool | PZ2 |
| Tightening torque cover screws max. (Nm) | 4.00 |
| Tightening torque cover screws min. (Nm) | 2.00 |
| Tightening torque earthing screw max. (Nm) | 2.70 |
| Tightening torque earthing screw min. (Nm) | 1.50 |



Modifications and Services

| | |
|------------------------|---|
| Mechanical processing |  |
| Finishing and Assembly |  |
| Surface design |  |
| Special colours |  |

Equipment and accessories

| | | |
|--|-----------------------------|---|
| Tragschiene TS 35 Article No. 0111100535 | Stahl verzinkt |    |
| Montageplatte Stahlblech Article No. 0112100500 | Stahl verzinkt |    |
| Wandlaschen M6 (4 Stück) Article No. 0113100541 | Edelstahl |    |
| Silikon Deckeldichtung Article No. 1980099999 | Silikon | |
| Mastbefestigung MBFIX Article No. 0313000023 | Edelstahl |    |
| Außenscharniere Alu (2 Stück) Article No. 0114000101 | Aluminium pulverbeschichtet |    |
| EMV geschützte Ausführung Article No. 1980000119 | - | |
| Tragschienenadapter TSFIX35 Article No. 0314000009 | Polyamid 6 (PA6) |    |
| Schutzleiteranschluss Article No. 3000000051 | Edelstahl | |
| Erdungsbolzen M6 Article No. 3000000169 | Edelstahl | |
| Pulverbeschichtung gemäß DIN EN 45545-2:2016 für Bahnanwendungen Article No. 8600000010 | | |



INDIVIDUALITY IS OUR STANDARD

With our extensive machinery and a highly motivated team, we transform our standard products into your individual solution.



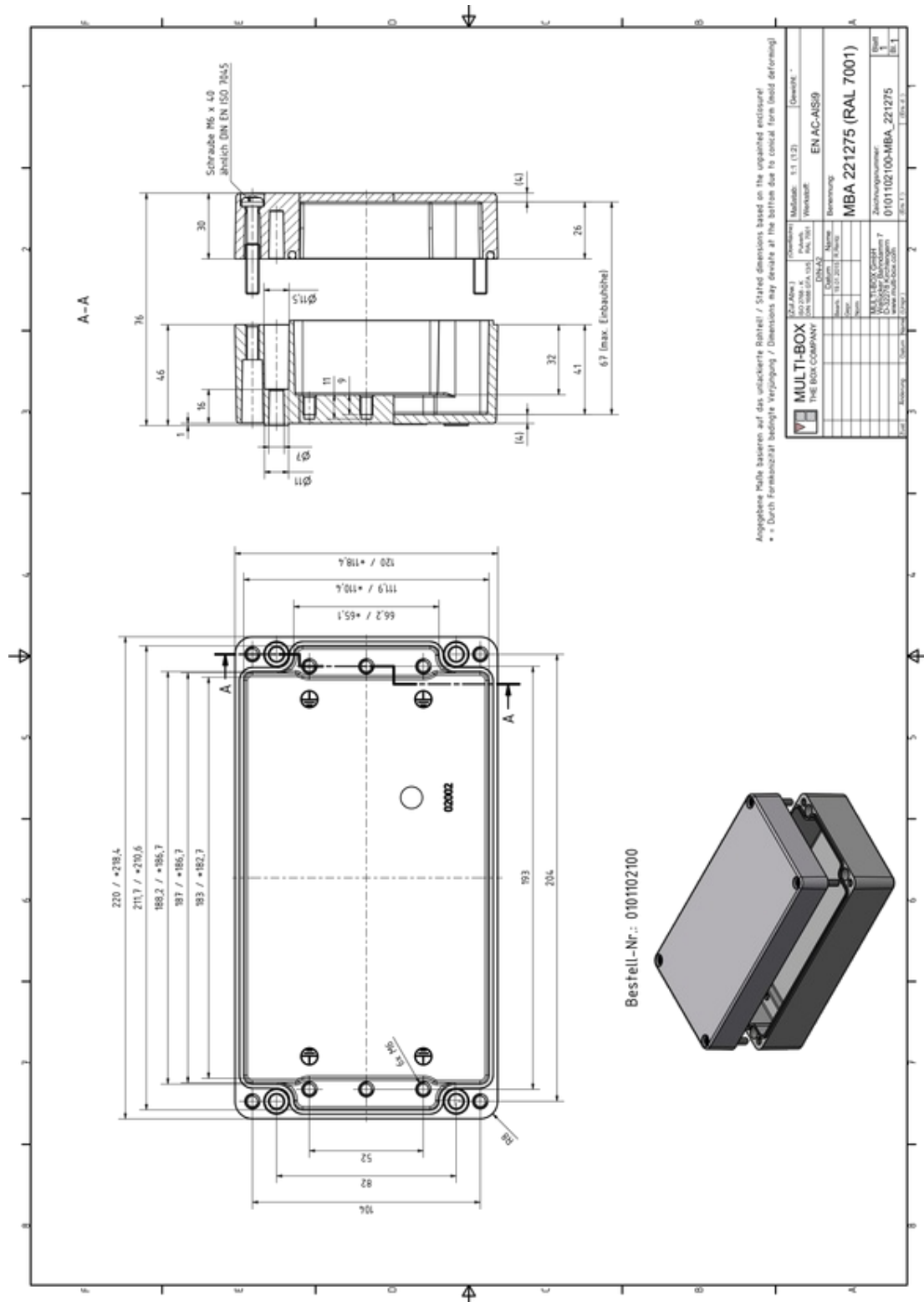

Under the following link you can download a higher resolution version of this drawing, including 3D construction data set:
<https://www.multi-box.com/gehaeuse/enclosures/industrial-enclosures/metal-enclosures/aluminium-enclosures/mba/mba-221275>